



# RF Power LDMOS Transistors

## N-Channel Enhancement-Mode Lateral MOSFETs

These RF power transistors are designed for applications operating at frequencies between 960 and 1215 MHz such as distance measuring equipment (DME), transponders and secondary radars for air traffic control. These devices are suitable for use in pulse applications, including Mode S ELM.

- Typical Pulse Performance:  $V_{DD} = 50$  Volts,  $I_{DQ} = 200$  mA

| Application               | Signal Type  | $P_{out}^{(1)}$<br>(W) | Freq.<br>(MHz) | $G_{ps}$<br>(dB) | $\eta_D$<br>(%) |
|---------------------------|--|------------------------|----------------|------------------|-----------------|
| Narrowband<br>Short Pulse | Pulse<br>(128 $\mu$ sec, 10% Duty Cycle)   | 500 Peak               | 1030           | 19.7             | 62.0            |
| Narrowband<br>Mode S ELM  | Pulse<br>(48 $\times$ (32 $\mu$ sec on, 18 $\mu$ sec off),<br>Period 2.4 msec,<br>6.4% Long-term Duty Cycle) | 500 Peak               | 1030           | 19.7             | 62.0            |
| Broadband                 | Pulse<br>(128 $\mu$ sec, 10% Duty Cycle)   | 500 Peak               | 960-1215       | 18.5             | 57.0            |

1. Minimum output power for each specified pulse condition.

- Capable of Handling 10:1 VSWR @ 50 Vdc, 1030 MHz, 500 Watts Peak Power

### Features

- Characterized with Series Equivalent Large-Signal Impedance Parameters
- Internally Matched for Ease of Use
- Qualified up to a Maximum of 50  $V_{DD}$  Operation
- Integrated ESD Protection
- Greater Negative Gate-Source Voltage Range for Improved Class C Operation

**MRF6V12500H**  
**MRF6V12500HS**  
**MRF6V12500GS**

**960-1215 MHz, 500 W, 50 V**  
**PULSE**  
**RF POWER LDMOS TRANSISTORS**

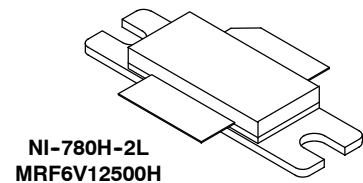

**NI-780H-2L**  
**MRF6V12500H**

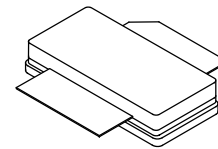

**NI-780S-2L**  
**MRF6V12500HS**

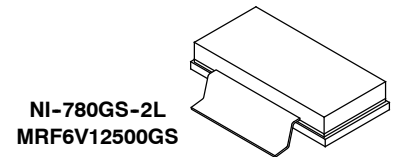

**NI-780GS-2L**  
**MRF6V12500GS**

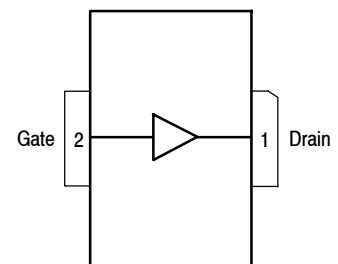

(Top View)

Note: The backside of the package is the source terminal for the transistor.

**Figure 1. Pin Connections**



**Table 1. Maximum Ratings**

| Rating                               | Symbol    | Value       | Unit |
|--------------------------------------|-----------|-------------|------|
| Drain-Source Voltage                 | $V_{DSS}$ | -0.5, +110  | Vdc  |
| Gate-Source Voltage                  | $V_{GS}$  | -6.0, +10   | Vdc  |
| Storage Temperature Range            | $T_{stg}$ | -65 to +150 | °C   |
| Case Operating Temperature           | $T_C$     | 150         | °C   |
| Operating Junction Temperature (1,2) | $T_J$     | 225         | °C   |

**Table 2. Thermal Characteristics**

| Characteristic  | Symbol          | Value (2,3) | Unit |
|---|-----------------|-------------|------|
| Thermal Impedance, Junction to Case<br>Case Temperature 80°C, 500 W Peak, 128 $\mu$ sec Pulse Width, 10% Duty Cycle | $Z_{\theta JC}$ | 0.044       | °C/W |

**Table 3. ESD Protection Characteristics**

| Test Methodology                      | Class             |
|---------------------------------------|-------------------|
| Human Body Model (per JESD22-A114)    | 2, passes 2600 V  |
| Machine Model (per EIA/JESD22-A115)   | B, passes 200 V   |
| Charge Device Model (per JESD22-C101) | IV, passes 2000 V |

**Table 4. Electrical Characteristics** ( $T_A = 25^\circ\text{C}$  unless otherwise noted)

| Characteristic | Symbol | Min | Typ | Max | Unit |
|----------------|--------|-----|-----|-----|------|
|----------------|--------|-----|-----|-----|------|

**Off Characteristics**

|   |               |     |   |     |           |
|---|---------------|-----|---|-----|-----------|
| Gate-Source Leakage Current<br>( $V_{GS} = 5$ Vdc, $V_{DS} = 0$ Vdc)              | $I_{GSS}$     | —   | — | 10  | $\mu$ Adc |
| Drain-Source Breakdown Voltage<br>( $V_{GS} = 0$ Vdc, $I_D = 200$ mA)             | $V_{(BR)DSS}$ | 110 | — | —   | Vdc       |
| Zero Gate Voltage Drain Leakage Current<br>( $V_{DS} = 50$ Vdc, $V_{GS} = 0$ Vdc) | $I_{DSS}$     | —   | — | 20  | $\mu$ Adc |
| Zero Gate Voltage Drain Leakage Current<br>( $V_{DS} = 90$ Vdc, $V_{GS} = 0$ Vdc) | $I_{DSS}$     | —   | — | 200 | $\mu$ Adc |

**On Characteristics**

|   |              |     |      |     |     |
|---|--------------|-----|------|-----|-----|
| Gate Threshold Voltage<br>( $V_{DS} = 10$ Vdc, $I_D = 1.32$ mA)                             | $V_{GS(th)}$ | 0.9 | 1.7  | 2.4 | Vdc |
| Gate Quiescent Voltage<br>( $V_{DD} = 50$ Vdc, $I_D = 200$ mA, Measured in Functional Test) | $V_{GS(Q)}$  | 1.7 | 2.4  | 3.2 | Vdc |
| Drain-Source On-Voltage<br>( $V_{GS} = 10$ Vdc, $I_D = 3.26$ Adc)                           | $V_{DS(on)}$ | —   | 0.25 | —   | Vdc |

**Dynamic Characteristics (4)**

|   |           |   |      |   |    |
|---|-----------|---|------|---|----|
| Reverse Transfer Capacitance<br>( $V_{DS} = 50$ Vdc $\pm$ 30 mV(rms)ac @ 1 MHz, $V_{GS} = 0$ Vdc) | $C_{rss}$ | — | 0.2  | — | pF |
| Output Capacitance<br>( $V_{DS} = 50$ Vdc $\pm$ 30 mV(rms)ac @ 1 MHz, $V_{GS} = 0$ Vdc)           | $C_{oss}$ | — | 697  | — | pF |
| Input Capacitance<br>( $V_{DS} = 50$ Vdc, $V_{GS} = 0$ Vdc $\pm$ 30 mV(rms)ac @ 1 MHz)            | $C_{iss}$ | — | 1391 | — | pF |

1. Continuous use at maximum temperature will affect MTTF.
2. MTTF calculator available at <http://www.nxp.com/RF/calculators>.
3. Refer to AN1955, *Thermal Measurement Methodology of RF Power Amplifiers*. Go to <http://www.nxp.com/RF> and search for AN1955.
4. Part internally matched both on input and output.

(continued)

**Table 4. Electrical Characteristics** ( $T_A = 25^\circ\text{C}$  unless otherwise noted) (continued)

| Characteristic   | Symbol   | Min  | Typ  | Max  | Unit |
|--|----------|------|------|------|------|
| <b>Functional Tests</b> (In Freescale Narrowband Test Fixture, 50 ohm system) $V_{DD} = 50\text{ Vdc}$ , $I_{DQ} = 200\text{ mA}$ , $P_{out} = 500\text{ W Peak}$ (50 W Avg.), $f = 1030\text{ MHz}$ , 128 $\mu\text{sec}$ Pulse Width, 10% Duty Cycle |          |      |      |      |      |
| Power Gain   | $G_{ps}$ | 18.5 | 19.7 | 22.0 | dB   |
| Drain Efficiency   | $\eta_D$ | 58.0 | 62.0 | —    | %    |
| Input Return Loss  | IRL      | —    | -18  | -9   | dB   |

**Typical Broadband Performance — 960-1215 MHz** (In Freescale 960-1215 MHz Test Fixture, 50 ohm system)  $V_{DD} = 50\text{ Vdc}$ ,  $I_{DQ} = 200\text{ mA}$ ,  $P_{out} = 500\text{ W Peak}$  (50 W Avg.),  $f = 960\text{-}1215\text{ MHz}$ , 128  $\mu\text{sec}$  Pulse Width, 10% Duty Cycle

|                  |          |   |      |   |    |
|------------------|----------|---|------|---|----|
| Power Gain       | $G_{ps}$ | — | 18.5 | — | dB |
| Drain Efficiency | $\eta_D$ | — | 57.0 | — | %  |

**Table 5. Ordering Information**

| Device          | Tape and Reel Information                            | Package     |
|-----------------|--|-------------|
| MRFE6V12500HR5  | R5 Suffix = 50 Units, 56 mm Tape Width, 13-inch Reel | NI-780H-2L  |
| MRFE6V12500HSR5 |  | NI-780S-2L  |
| MRFE6V12500GSR5 |  | NI-780GS-2L |

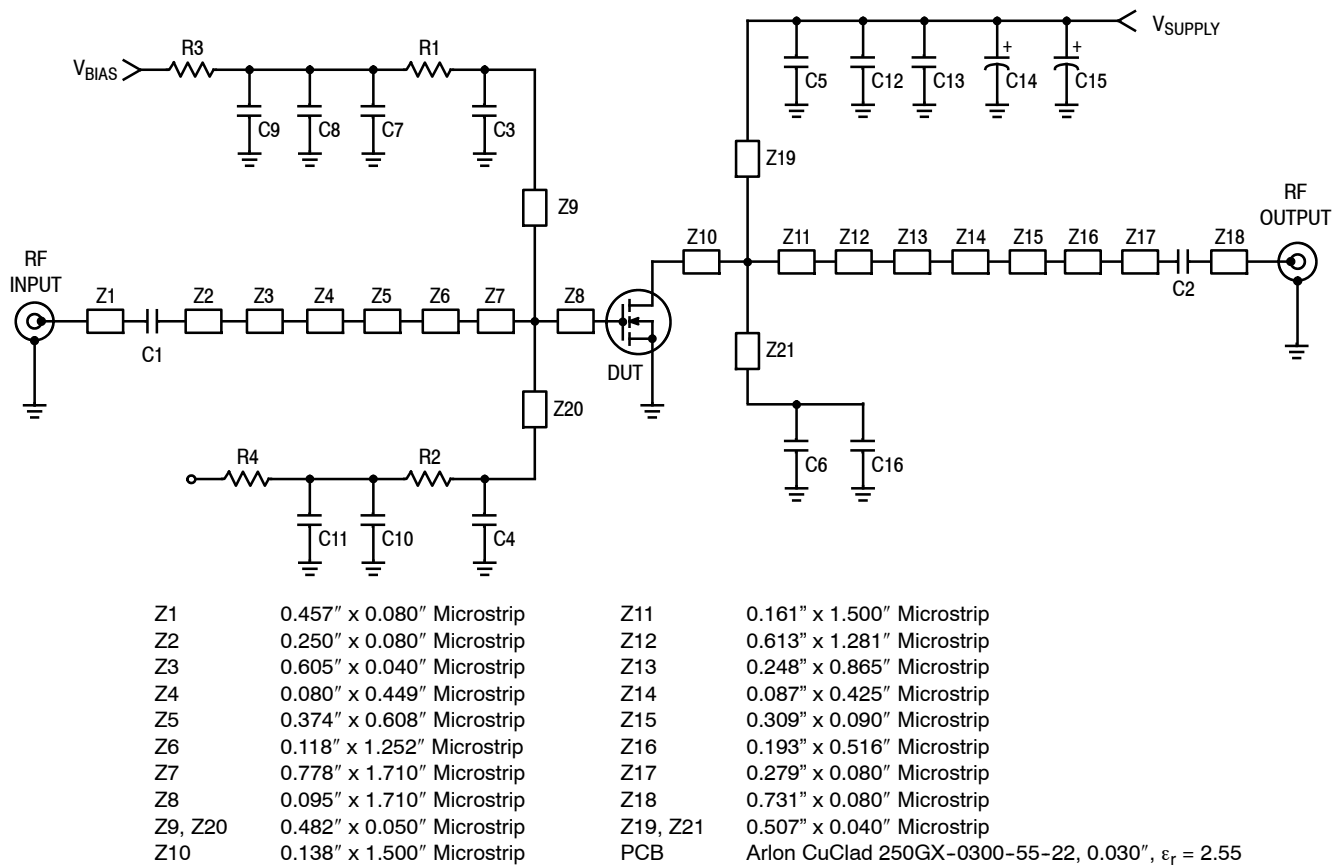

Figure 2. MRF6V12500H(HS) Test Circuit Schematic

Table 6. MRF6V12500H(HS) Test Circuit Component Designations and Values

| Part              | Description                               | Part Number          | Manufacturer |
|-------------------|---|----------------------|--------------|
| C1, C2            | 5.1 pF Chip Capacitors                    | ATC100B5R1CT500XT    | ATC          |
| C3, C4, C5, C6    | 33 pF Chip Capacitors                     | ATC100B330JT500XT    | ATC          |
| C7, C10           | 10 $\mu$ F, 50 V Chip Capacitors          | GRM55DR61H106KA88L   | Murata       |
| C8, C11, C13, C16 | 2.2 $\mu$ F, 100 V Chip Capacitors        | 2225X7R225KT3AB      | ATC          |
| C9                | 22 $\mu$ F, 25 V Chip Capacitor           | TPSD226M025R0200     | AVX          |
| C12               | 1 $\mu$ F, 100 V Chip Capacitor           | GRM31CR72A105KA01L   | Murata       |
| C14, C15          | 470 $\mu$ F, 63 V Electrolytic Capacitors | MCGPR63V477M13X26-RH | Multicomp    |
| R1, R2            | 56 $\Omega$ , 1/4 W Chip Resistors        | CRCW120656R0FKEA     | Vishay       |
| R3, R4            | 0 $\Omega$ , 3 A Chip Resistors           | CRCW12060000Z0EA     | Vishay       |

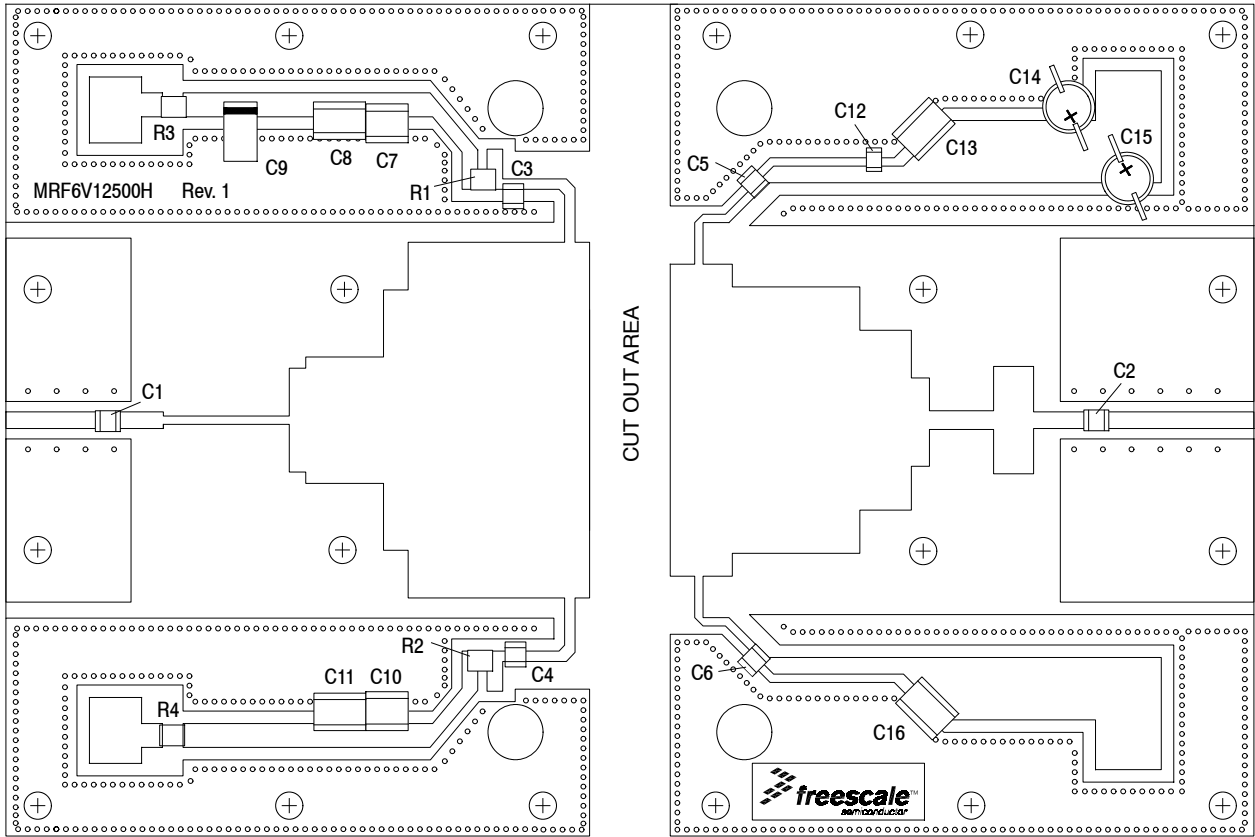

Figure 3. MRF6V12500H(HS) Test Circuit Component Layout

## TYPICAL CHARACTERISTICS

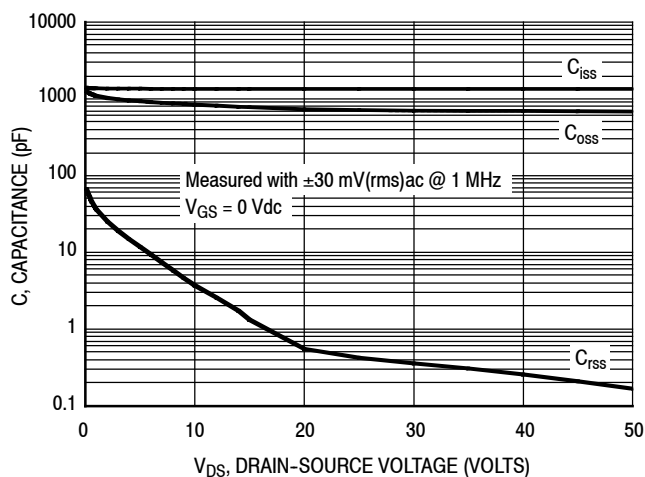

Figure 4. Capacitance versus Drain-Source Voltage

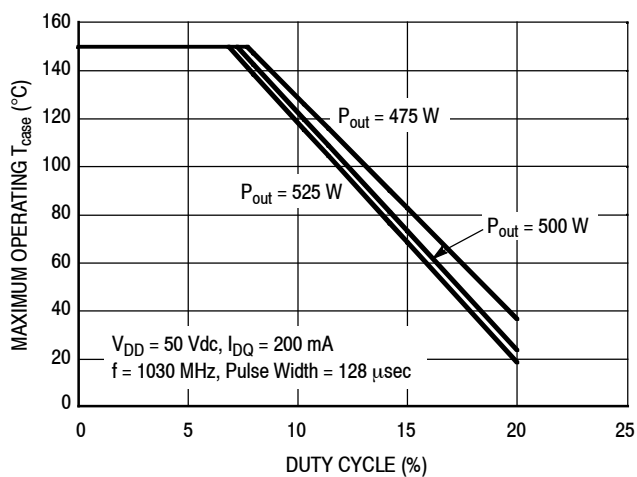

Figure 5. Safe Operating Area

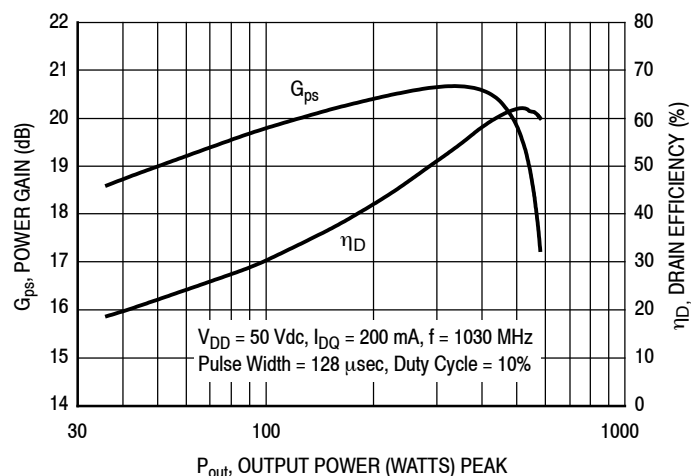

Figure 6. Power Gain and Drain Efficiency versus Output Power

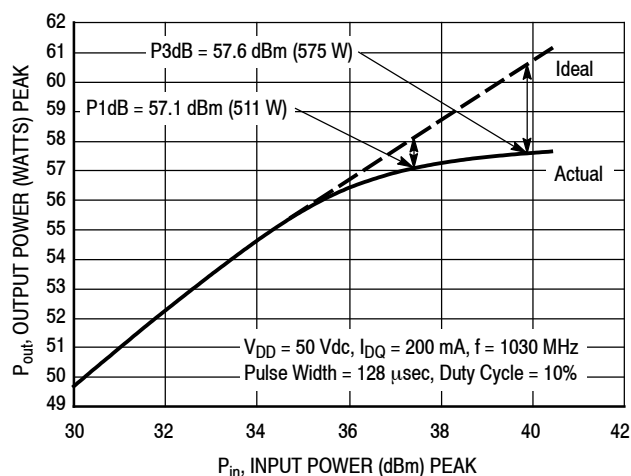

Figure 7. Output Power versus Input Power

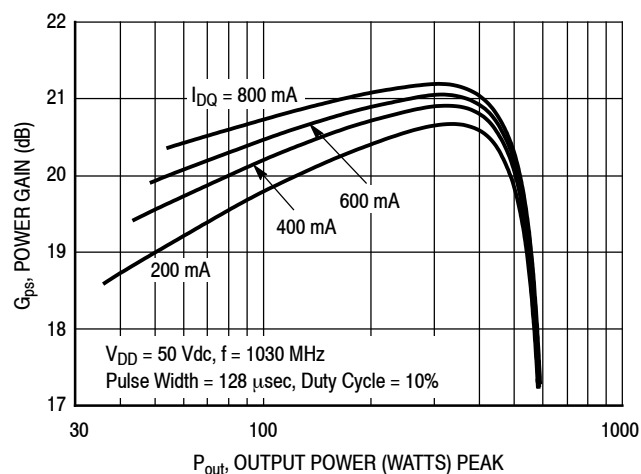

Figure 8. Power Gain versus Output Power

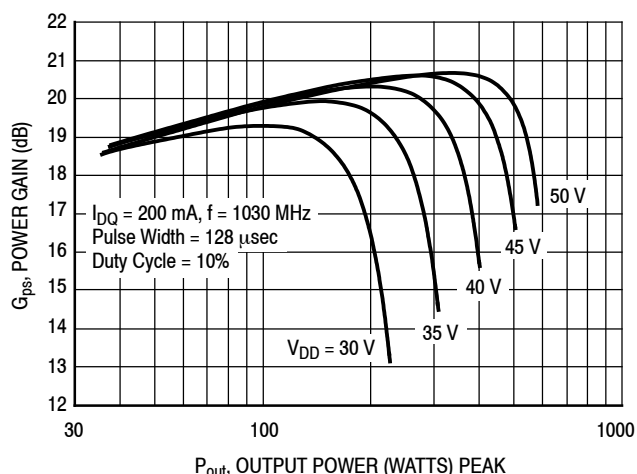

Figure 9. Power Gain versus Output Power

## TYPICAL CHARACTERISTICS

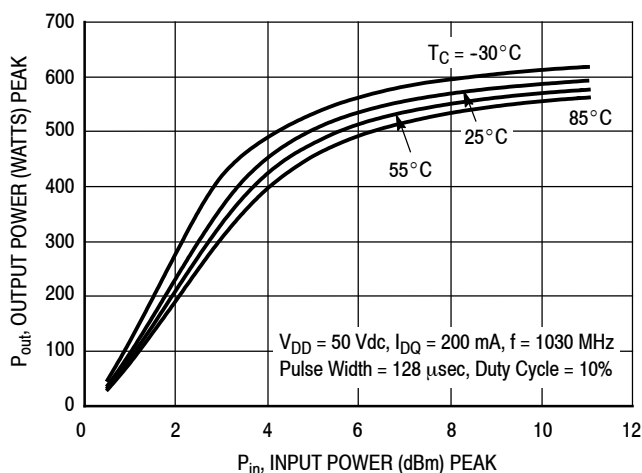

Figure 10. Output Power versus Input Power

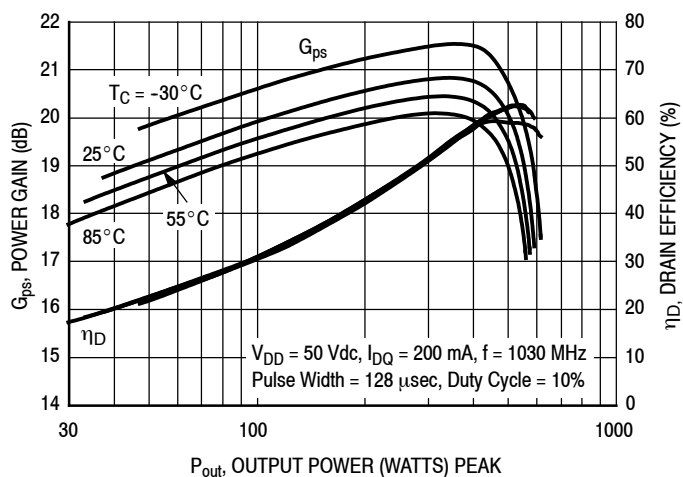
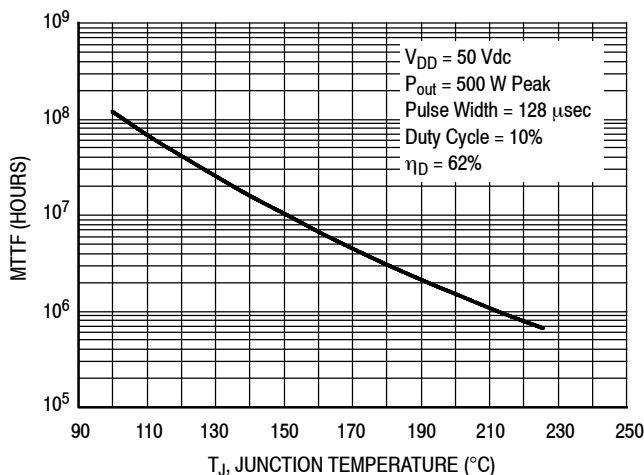

Figure 11. Power Gain and Drain Efficiency versus Output Power



**Note:** MTTF value represents the total cumulative operating time under indicated test conditions.

MTTF calculator available at <http://www.nxp.com/RF/calculators>.

Figure 12. MTTF versus Junction Temperature

$V_{DD} = 50 \text{ Vdc}$ ,  $I_{DQ} = 200 \text{ mA}$ ,  $P_{out} = 500 \text{ W Peak}$

| f<br>MHz | $Z_{source}$<br>Ω | $Z_{load}$<br>Ω |
|----------|-------------------|-----------------|
| 1030     | $1.36 - j1.27$    | $2.50 - j0.17$  |

$Z_{source}$  = Test circuit impedance as measured from gate to ground.

$Z_{load}$  = Test circuit impedance as measured from drain to ground.

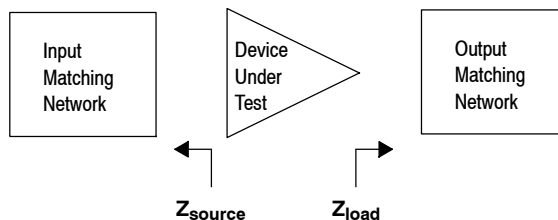

Figure 13. Series Equivalent Source and Load Impedance

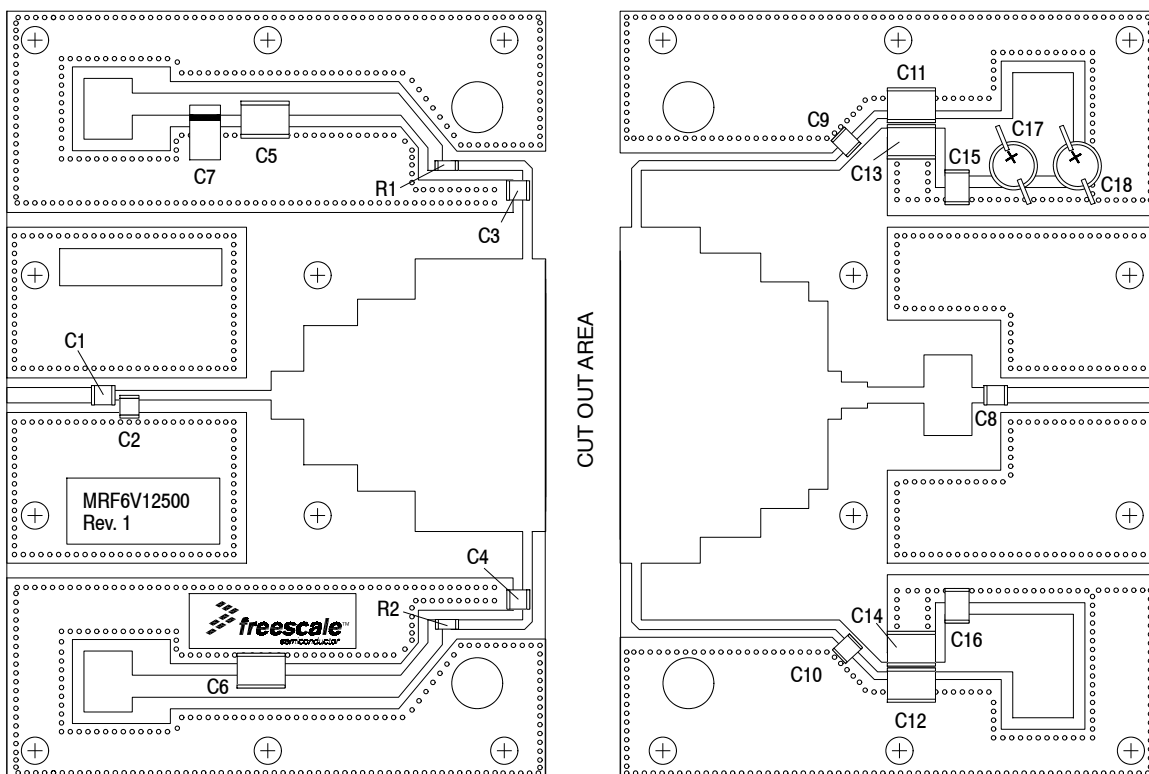

Figure 14. MRF6V12500H(HS) Test Circuit Component Layout — 960-1215 MHz

Table 7. MRF6V12500H(HS) Test Circuit Component Designations and Values — 960-1215 MHz

| Part             | Description                               | Part Number          | Manufacturer |
|------------------|---|----------------------|--------------|
| C1               | 2.2 pF Chip Capacitor                     | ATC100B2R2JT500XT    | ATC          |
| C2               | 0.2 pF Chip Capacitor                     | ATC100B0R2BT500XT    | ATC          |
| C3, C4           | 33 pF Chip Capacitors                     | ATC100B330JT500XT    | ATC          |
| C5, C6, C11, C12 | 2.2 $\mu$ F, 100 V Chip Capacitors        | G2225X7R225KT3AB     | ATC          |
| C7               | 22 $\mu$ F, 35 V Tantalum Capacitor       | T491X226K035AT       | Kemet        |
| C8               | 8.2 pF Chip Capacitor                     | ATC100B8R2CT500XT    | ATC          |
| C9, C10          | 39 pF Chip Capacitors                     | ATC100B390JT500XT    | ATC          |
| C13, C14         | 0.022 $\mu$ F, 100 V Chip Capacitors      | C1825C223K1GAC       | Kemet        |
| C15, C16         | 0.10 $\mu$ F, 100 V Chip Capacitors       | C1812F104K1RAC       | Kemet        |
| C17, C18         | 470 $\mu$ F, 63 V Electrolytic Capacitors | MCGPR63V477M13X26-RH | Multicomp    |
| R1, R2           | 22 $\Omega$ , 1/4 W Chip Resistors        | CRCW120622R0FKEA     | Vishay       |
| PCB              | 0.030", $\epsilon_r = 2.55$               | AD255A               | Arlon        |



### TYPICAL CHARACTERISTICS — 960-1215 MHz

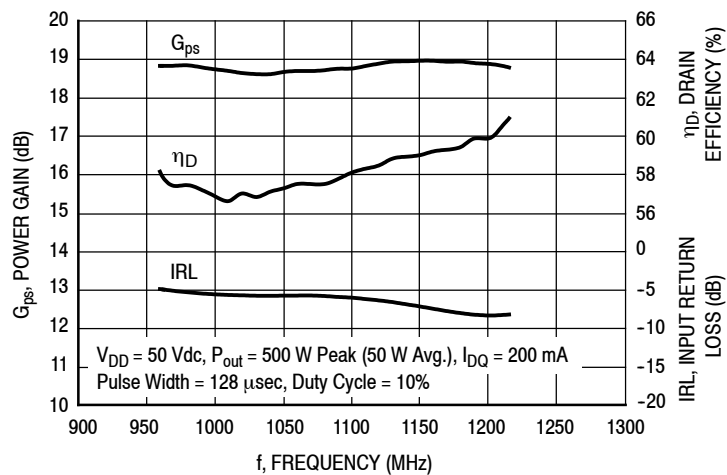

**Figure 15. Power Gain, Drain Efficiency and IRL versus Frequency**

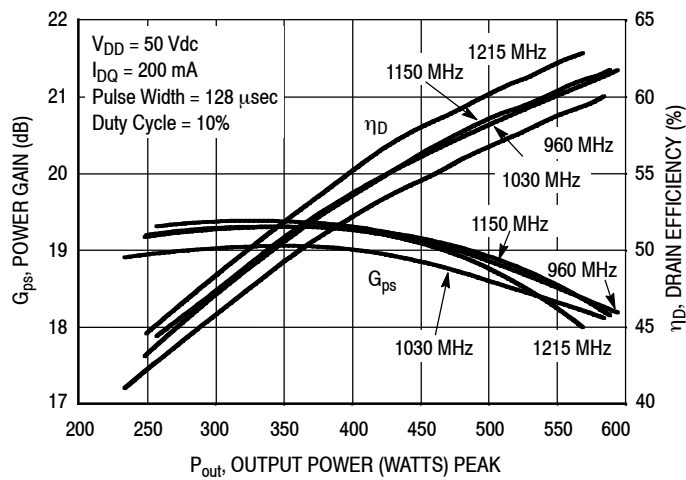

**Figure 16. Power Gain and Drain Efficiency versus Output Power**

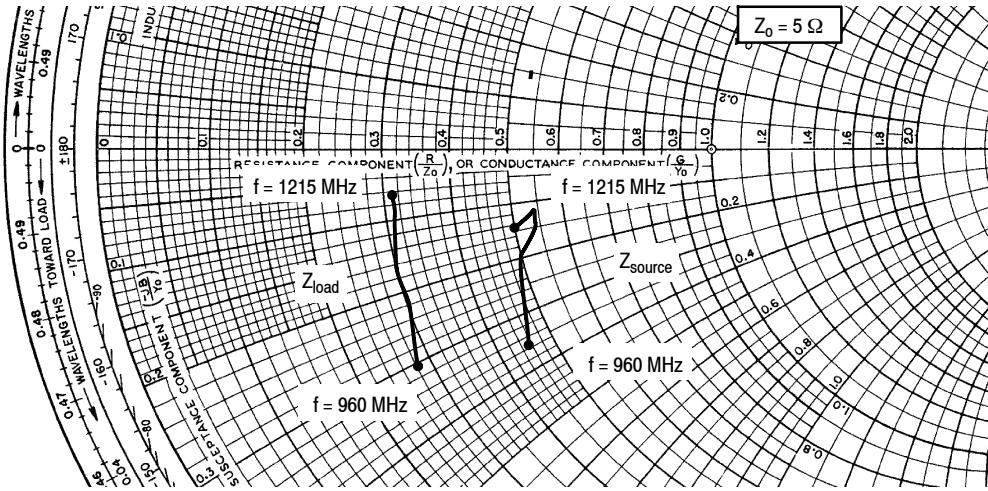

$V_{DD} = 50 \text{ Vdc}$ ,  $I_{DQ} = 200 \text{ mA}$ ,  $P_{out} = 500 \text{ W Peak}$

| f<br>MHz | $Z_{source}$<br>$\Omega$ | $Z_{load}$<br>$\Omega$ |
|----------|--------------------------|------------------------|
| 960      | $2.25 - j1.78$           | $1.38 - j1.53$         |
| 1030     | $2.51 - j1.02$           | $1.48 - j1.11$         |
| 1090     | $2.69 - j0.73$           | $1.51 - j0.78$         |
| 1150     | $2.71 - j0.65$           | $1.53 - j0.49$         |
| 1215     | $2.48 - j0.76$           | $1.53 - j0.33$         |

$Z_{source}$  = Test circuit impedance as measured from gate to ground.

$Z_{load}$  = Test circuit impedance as measured from drain to ground.

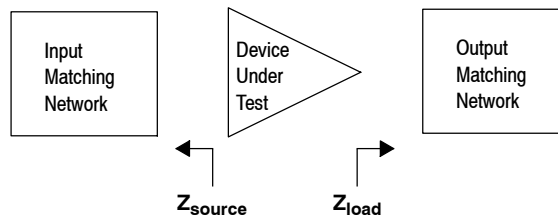

Figure 17. Series Equivalent Source and Load Impedance — 960-1215 MHz



NOTES:

1. DIMENSIONING AND TOLERANCING PER ANSI Y14.5M-1994.
2. CONTROLLING DIMENSION: INCH.
3. DELETED
4. DIMENSION H IS MEASURED .030 (.762) AWAY FROM PACKAGE BODY.

STYLE 1:

- PIN 1. DRAIN  
 2. GATE  
 3. SOURCE

| DIM | INCH      |         | MILLIMETER |         | DIM | INCH   |        | MILLIMETER |         |
|-----|-----------|---------|------------|---------|-----|--------|--------|------------|---------|
|     | MIN       | MAX     | MIN        | MAX     |     | MIN    | MAX    | MIN        | MAX     |
| A   | 1.335     | – 1.345 | 33.91      | – 34.16 | R   | .365   | – .375 | 9.27       | – 9.53  |
| B   | .380      | – .390  | 9.65       | – 9.91  | S   | .365   | – .375 | 9.27       | – 9.52  |
| C   | .125      | – .170  | 3.18       | – 4.32  | aaa | – .005 | –      | –          | 0.127 – |
| D   | .495      | – .505  | 12.57      | – 12.83 | bbb | – .010 | –      | –          | 0.254 – |
| E   | .035      | – .045  | 0.89       | – 1.14  | ccc | – .015 | –      | –          | 0.381 – |
| F   | .003      | – .006  | 0.08       | – 0.15  | –   | –      | –      | –          | –       |
| G   | 1.100 BSC |         | 27.94 BSC  |         | –   | –      | –      | –          | –       |
| H   | .057      | – .067  | 1.45       | – 1.7   | –   | –      | –      | –          | –       |
| K   | .170      | – .210  | 4.32       | – 5.33  | –   | –      | –      | –          | –       |
| M   | .774      | – .786  | 19.66      | – 19.96 | –   | –      | –      | –          | –       |
| N   | .772      | – .788  | 19.6       | – 20    | –   | –      | –      | –          | –       |
| Q   | ∅.118     | – ∅.138 | ∅3         | – ∅3.51 | –   | –      | –      | –          | –       |

|  |                          |                            |
|--|--------------------------|----------------------------|
| © NXP SEMICONDUCTORS N.V.<br>ALL RIGHTS RESERVED | MECHANICAL OUTLINE       | PRINT VERSION NOT TO SCALE |
| TITLE:<br><br>NI-780                             | DOCUMENT NO: 98ASB15607C | REV: H                     |
|  | STANDARD: NON-JEDEC      |                            |
|  | SOT1792-1                | 14 MAR 2016                |

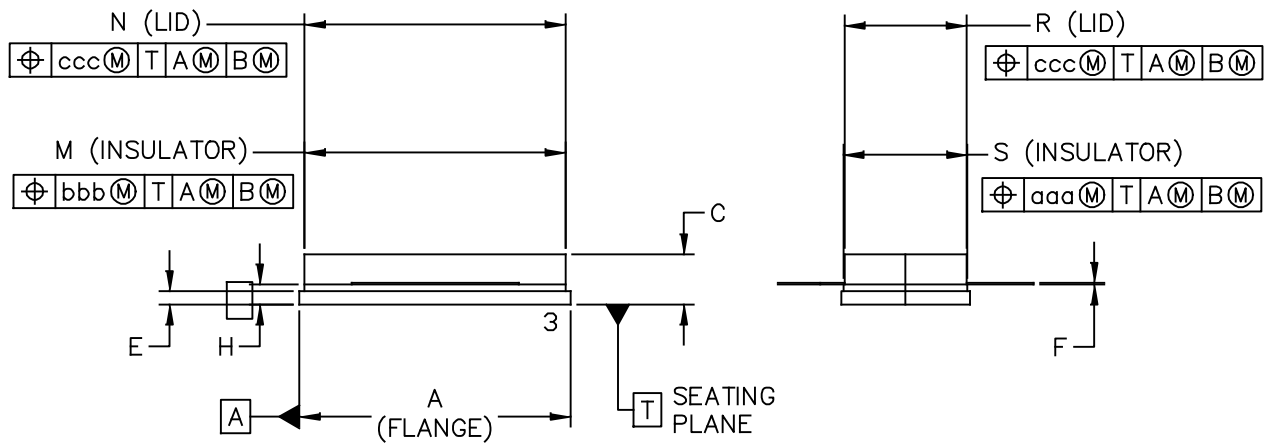
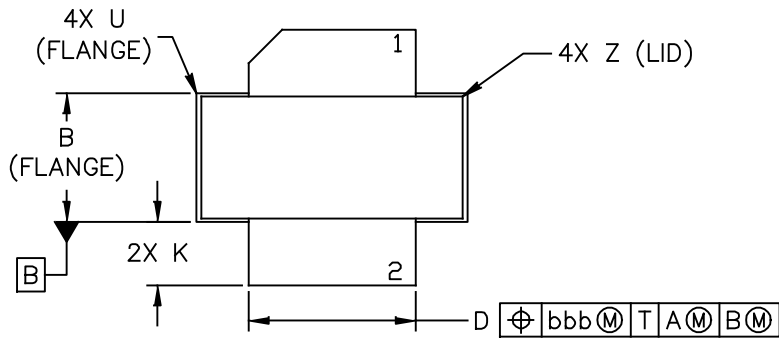

|   |                          |                            |
|---|--------------------------|----------------------------|
| © NXP SEMICONDUCTORS N. V.<br>ALL RIGHTS RESERVED | MECHANICAL OUTLINE       | PRINT VERSION NOT TO SCALE |
| TITLE:<br><br>NI-780S                             | DOCUMENT NO: 98ASB16718C | REV: J                     |
|   | STANDARD: NON-JEDEC      |                            |
|   | SOT1793-1                | 15 MAR 2016                |

NOTES:

1. DIMENSIONING AND TOLERANCING PER ANSI Y14.5M–1994.
2. CONTROLLING DIMENSION: INCH.
3. DELETED
4. DIMENSION H IS MEASURED .030 (0.762) AWAY FROM PACKAGE BODY.

STYLE 1:

- PIN 1. DRAIN
2. GATE
3. SOURCE

| DIM | INCH |        | MILLIMETER |         | DIM | INCH |        | MILLIMETER |         |
|-----|------|--------|------------|---------|-----|------|--------|------------|---------|
|     | MIN  | MAX    | MIN        | MAX     |     | MIN  | MAX    | MIN        | MAX     |
| A   | .805 | – .815 | 20.45      | – 20.7  | U   | –    | – .040 | –          | – 1.02  |
| B   | .380 | – .390 | 9.65       | – 9.91  | Z   | –    | – .030 | –          | – 0.76  |
| C   | .125 | – .170 | 3.18       | – 4.32  | aaa | –    | .005 – | –          | 0.127 – |
| D   | .495 | – .505 | 12.57      | – 12.83 | bbb | –    | .010 – | –          | 0.254 – |
| E   | .035 | – .045 | 0.89       | – 1.14  | ccc | –    | .015 – | –          | 0.381 – |
| F   | .003 | – .006 | 0.08       | – 0.15  | –   | –    | – –    | –          | – –     |
| H   | .057 | – .067 | 1.45       | – 1.7   | –   | –    | – –    | –          | – –     |
| K   | .170 | – .210 | 4.32       | – 5.33  | –   | –    | – –    | –          | – –     |
| M   | .774 | – .786 | 19.61      | – 20.02 | –   | –    | – –    | –          | – –     |
| N   | .772 | – .788 | 19.61      | – 20.02 | –   | –    | – –    | –          | – –     |
| R   | .365 | – .375 | 9.27       | – 9.53  | –   | –    | – –    | –          | – –     |
| S   | .365 | – .375 | 9.27       | – 9.52  | –   | –    | – –    | –          | – –     |

© NXP SEMICONDUCTORS N.V.  
ALL RIGHTS RESERVED

MECHANICAL OUTLINE

PRINT VERSION NOT TO SCALE

TITLE:

NI–780S

DOCUMENT NO: 98ASB16718C

REV: J

STANDARD: NON–JEDEC

SOT1793–1

15 MAR 2016

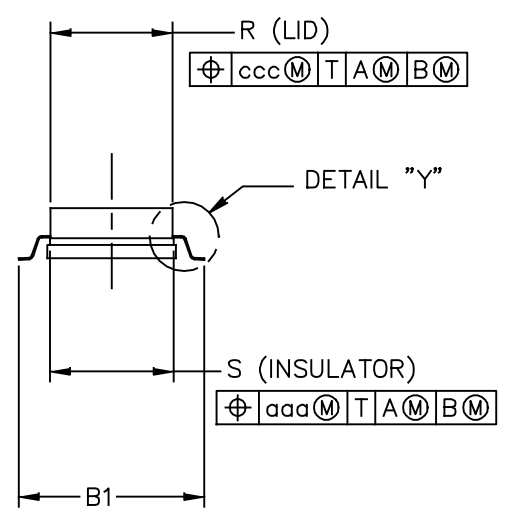
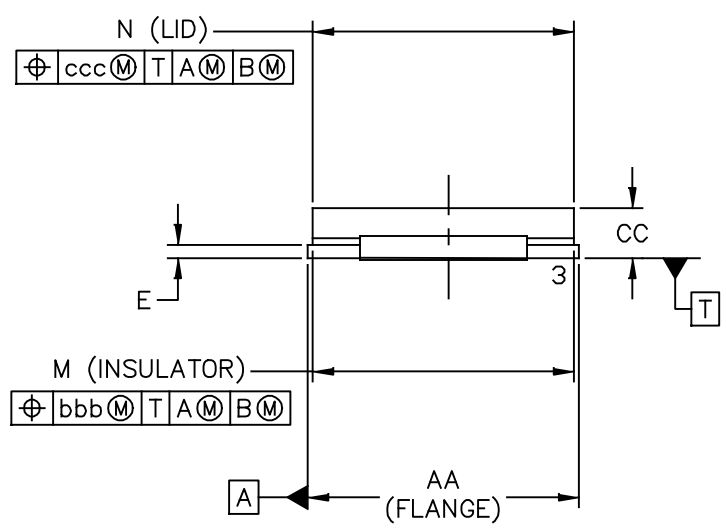
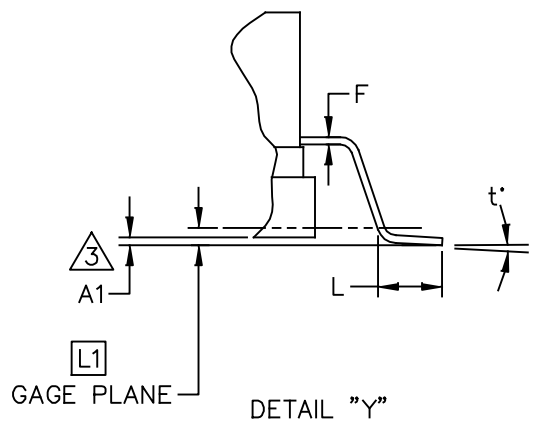
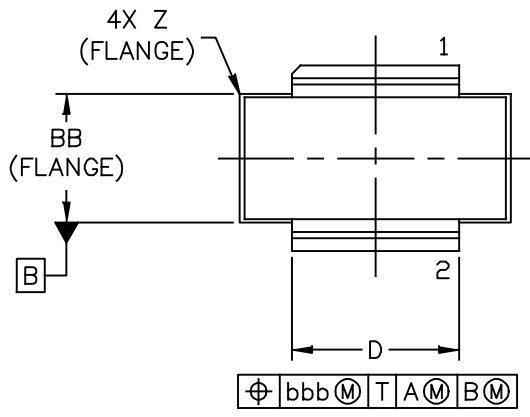

|   |                          |                            |
|---|--------------------------|----------------------------|
| © NXP SEMICONDUCTORS N. V.<br>ALL RIGHTS RESERVED | MECHANICAL OUTLINE       | PRINT VERSION NOT TO SCALE |
| TITLE:<br><br>NI-780GS-2L                         | DOCUMENT NO: 98ASA00193D | REV: C                     |
|   | STANDARD: NON-JEDEC      |                            |
|   | SOT1802-1                | 22 FEB 2016                |

NOTES:

1. DIMENSIONING AND TOLERANCING PER ANSI Y14.5M–1994.

2. CONTROLLING DIMENSION: INCH.

3. DIMENSION A1 IS MEASURED WITH REFERENCE TO DATUM T. THE POSITIVE VALUE IMPLIES THAT THE PACKAGE BOTTOM IS HIGHER THAN THE LEAD BOTTOM.

| DIM  | INCH     |      | MILLIMETER         |       | DIM                                  | INCH                       |             | MILLIMETER |       |
|--|----------|------|--------------------|-------|--------------------------------------|----------------------------|-------------|------------|-------|
|  | MIN      | MAX  | MIN                | MAX   |                                      | MIN                        | MAX         | MIN        | MAX   |
| AA   | .805     | .815 | 20.45              | 20.70 | Z                                    | R.000                      | R.040       | R0.00      | R1.02 |
| A1   | .002     | .008 | 0.05               | 0.20  | t                                    | 0                          | 8           | 0          | 8     |
| BB   | .380     | .390 | 9.65               | 9.91  |                                      |                            |             |            |       |
| B1   | .546     | .562 | 13.87              | 14.27 |                                      |                            |             |            |       |
| CC   | .125     | .170 | 3.18               | 4.32  | aaa                                  | .005                       |             | 0.13       |       |
| D  | .495     | .505 | 12.57              | 12.83 | bbb                                  | .010                       |             | 0.25       |       |
| E  | .035     | .045 | 0.89               | 1.14  | ccc                                  | .015                       |             | 0.38       |       |
| F  | .003     | .006 | 0.08               | 0.15  |                                      |                            |             |            |       |
| L  | .038     | .046 | 0.97               | 1.17  |                                      |                            |             |            |       |
| L1   | .010 BSC |      | 0.25 BSC           |       |                                      |                            |             |            |       |
| M  | .774     | .786 | 19.66              | 19.96 |                                      |                            |             |            |       |
| N  | .772     | .788 | 19.61              | 20.02 |                                      |                            |             |            |       |
| R  | .365     | .375 | 9.27               | 9.53  |                                      |                            |             |            |       |
| S  | .365     | .375 | 9.27               | 9.53  |                                      |                            |             |            |       |
| © NXP SEMICONDUCTORS N.V.<br>ALL RIGHTS RESERVED |          |      | MECHANICAL OUTLINE |       |                                      | PRINT VERSION NOT TO SCALE |             |            |       |
| TITLE:<br><br>NI-780GS-2L                        |          |      |                    |       | DOCUMENT NO: 98ASA00193D      REV: C |                            |             |            |       |
|  |          |      |                    |       | STANDARD: NON-JEDEC                  |                            |             |            |       |
|  |          |      |                    |       | SOT1802-1                            |                            | 22 FEB 2016 |            |       |



## PRODUCT DOCUMENTATION AND SOFTWARE

Refer to the following resources to aid your design process.

### Application Notes

- AN1908: Solder Reflow Attach Method for High Power RF Devices in Air Cavity Packages
- AN1955: Thermal Measurement Methodology of RF Power Amplifiers

### Engineering Bulletins

- EB212: Using Data Sheet Impedances for RF LDMOS Devices

### Software

- Electromigration MTTF Calculator
- RF High Power Model

### To Download Resources Specific to a Given Part Number:

1. Go to <http://www.nxp.com/RF>
2. Search by part number
3. Click part number link
4. Choose the desired resource from the drop down menu

## REVISION HISTORY

The following table summarizes revisions to this document.

| Revision | Date       | Description   |
|----------|------------|---|
| 0        | Sept. 2009 | <ul style="list-style-type: none"> <li>• Initial Release of Data Sheet</li> </ul>   |
| 1        | Apr. 2010  | <ul style="list-style-type: none"> <li>• Operating Junction Temperature increased from 200°C to 225°C in Maximum Ratings table and related “Continuous use at maximum temperature will affect MTTF” footnote added, p. 1</li> <li>• Added RF High Power Model availability to Product Software, p. 9</li> </ul>   |
| 2        | Sept. 2010 | <ul style="list-style-type: none"> <li>• Maximum Ratings table: corrected <math>V_{DSS}</math> from -0.5, +100 to -0.5, +110 Vdc, p. 2</li> <li>• Added 960-1215 MHz Broadband application as follows:                             <ul style="list-style-type: none"> <li>- Typical Performance, p. 1, 2</li> <li>- Fig. 13, Test Circuit Component Layout and Table 6, Test Circuit Component Designations and Values, p. 8</li> <li>- Fig. 14, Pulsed Power Gain, Drain Efficiency and IRL versus Frequency, p. 9</li> <li>- Fig. 15, Power Gain and Drain Efficiency versus Output Power, p. 9</li> <li>- Fig. 16, Series Equivalent Source and Load Impedance, p. 10</li> </ul> </li> </ul> |
| 3        | June 2012  | <ul style="list-style-type: none"> <li>• Table 3, ESD Protection Characteristics: added the device’s ESD passing level as applicable to each ESD class, p. 2</li> <li>• Modified figure titles and/or graph axes labels to clarify application use, p. 5, 6, 9</li> <li>• Fig. 6, Output Power versus Input Power: corrected <math>P_{out}</math>, Output Power unit of measure to watts, p. 5</li> <li>• Fig. 9, Output Power versus Input Power: corrected <math>P_{out}</math>, Output Power unit of measure to watts, p. 6</li> <li>• Fig. 11, MTTF versus Junction Temperature: MTTF end temperature on graph changed to match maximum operating junction temperature, p. 6</li> </ul>     |
| 4        | Mar. 2015  | <ul style="list-style-type: none"> <li>• MRF6V12500HR3 tape and reel option replaced with MRF6V12500HR5 and MRF6V12500HSR3 tape and reel option replaced with MRF6V12500HSR5 per PCN15551</li> <li>• Modified figure titles and/or graph axes labels to clarify application use, pp. 6, 7, 9</li> <li>• Typical performance table: added Narrowband Mode S ELM application data, p. 1</li> </ul>  |
| 5        | July 2016  | <ul style="list-style-type: none"> <li>• Added part number MRF6V12500GS, pp. 1, 3</li> <li>• Added NI-780GS-2L package isometric, p. 1, and Mechanical Outline, pp. 15-16</li> </ul>  |

## ***How to Reach Us:***

**Home Page:**  
[freescale.com](http://freescale.com)

**Web Support:**  
[freescale.com/support](http://freescale.com/support)

Information in this document is provided solely to enable system and software implementers to use Freescale products. There are no express or implied copyright licenses granted hereunder to design or fabricate any integrated circuits based on the information in this document.

Freescale reserves the right to make changes without further notice to any products herein. Freescale makes no warranty, representation, or guarantee regarding the suitability of its products for any particular purpose, nor does Freescale assume any liability arising out of the application or use of any product or circuit, and specifically disclaims any and all liability, including without limitation consequential or incidental damages. "Typical" parameters that may be provided in Freescale data sheets and/or specifications can and do vary in different applications, and actual performance may vary over time. All operating parameters, including "typicals," must be validated for each customer application by customer's technical experts. Freescale does not convey any license under its patent rights nor the rights of others. Freescale sells products pursuant to standard terms and conditions of sale, which can be found at the following address: [freescale.com/SalesTermsandConditions](http://freescale.com/SalesTermsandConditions).

Freescale and the Freescale logo are trademarks of Freescale Semiconductor, Inc., Reg. U.S. Pat. & Tm. Off. All other product or service names are the property of their respective owners.

© 2009–2010, 2012, 2015–2016 Freescale Semiconductor, Inc.



Компания «Океан Электроники» предлагает заключение долгосрочных отношений при поставках импортных электронных компонентов на взаимовыгодных условиях!

Наши преимущества:

- Поставка оригинальных импортных электронных компонентов напрямую с производств Америки, Европы и Азии, а так же с крупнейших складов мира;
- Широкая линейка поставок активных и пассивных импортных электронных компонентов (более 30 млн. наименований);
- Поставка сложных, дефицитных, либо снятых с производства позиций;
- Оперативные сроки поставки под заказ (от 5 рабочих дней);
- Экспресс доставка в любую точку России;
- Помощь Конструкторского Отдела и консультации квалифицированных инженеров;
- Техническая поддержка проекта, помощь в подборе аналогов, поставка прототипов;
- Поставка электронных компонентов под контролем ВП;
- Система менеджмента качества сертифицирована по Международному стандарту ISO 9001;
- При необходимости вся продукция военного и аэрокосмического назначения проходит испытания и сертификацию в лаборатории (по согласованию с заказчиком);
- Поставка специализированных компонентов военного и аэрокосмического уровня качества (Xilinx, Altera, Analog Devices, Intersil, Interpoint, Microsemi, Actel, Aeroflex, Peregrine, VPT, Syfer, Eurofarad, Texas Instruments, MS Kennedy, Miteq, Cobham, E2V, MA-COM, Hittite, Mini-Circuits, General Dynamics и др.);

Компания «Океан Электроники» является официальным дистрибьютором и эксклюзивным представителем в России одного из крупнейших производителей разъемов военного и аэрокосмического назначения «JONHON», а так же официальным дистрибьютором и эксклюзивным представителем в России производителя высокотехнологичных и надежных решений для передачи СВЧ сигналов «FORSTAR».



## JONHON

«JONHON» (основан в 1970 г.)

Разъемы специального, военного и аэрокосмического назначения:

(Применяются в военной, авиационной, аэрокосмической, морской, железнодорожной, горно- и нефтедобывающей отраслях промышленности)

«FORSTAR» (основан в 1998 г.)

ВЧ соединители, коаксиальные кабели,  
кабельные сборки и микроволновые компоненты:

(Применяются в телекоммуникациях гражданского и специального назначения, в средствах связи, РЛС, а так же военной, авиационной и аэрокосмической отраслях промышленности).



Телефон: 8 (812) 309-75-97 (многоканальный)

Факс: 8 (812) 320-03-32

Электронная почта: [ocean@oceanchips.ru](mailto:ocean@oceanchips.ru)

Web: <http://oceanchips.ru/>

Адрес: 198099, г. Санкт-Петербург, ул. Калинина, д. 2, корп. 4, лит. А