

1 Features

- Designed for 2.4 – 2.5 GHz and 4.9 – 5.9 GHz applications: 802.11a/b/g/j/n, Wi-Fi®
- Easy to integrate
- High efficiency
- Light weight
- Intended for SMD mounting
- Supplied in tape on reel

2 Description

Mixtus is intended for use with all dual-band Wi-Fi applications, including 802.11n MIMO. The antenna requires a ground plane, i.e. your device acts as an active part of the antenna and thus demands careful consideration concerning its placement.

3 Applications

- Mobile phones
- PDAs
- Portable Media Players (PMPs)
- Headsets
- PC-Cards
- Game Consoles
- Access Points
- Set-top-box
- Networked Digital TVs



4 Part No.

Mixtus: A10194



5 General data

Product name	Mixtus Wi-Fi
Part No.	A10194
Frequency	2.4 – 2.5 GHz and 4.9 – 5.9 GHz
Polarization	Linear
Operating temperature	-40 °C to +85 °C
Impedance with matching	50 Ω
Weight	0.2 g
Antenna type	SMD
Dimensions	10 x 10 x 0.9 [mm]

6 Electrical characteristics

	Typical performance	Conditions
Peak gain	1.8 dBi	Data given for the 2.4 – 2.5 GHz frequency range All data measured on Antenova's reference board part number A10194-U1
Average gain	-0.5 dBi	
Average efficiency	>75%	
Maximum Return Loss	-15 dB	
Maximum VSWR	1.4:1	
Peak gain	4.1 dBi	Data given for the 4.9 – 5.9 GHz frequency range All data measured on Antenova's reference board part number A10194-U1
Average gain	-2.3 dBi	
Average efficiency	>60%	
Maximum Return Loss	-11 dB	
Maximum VSWR	1.8:1	

7 Electrical performance

7-1 Return Loss

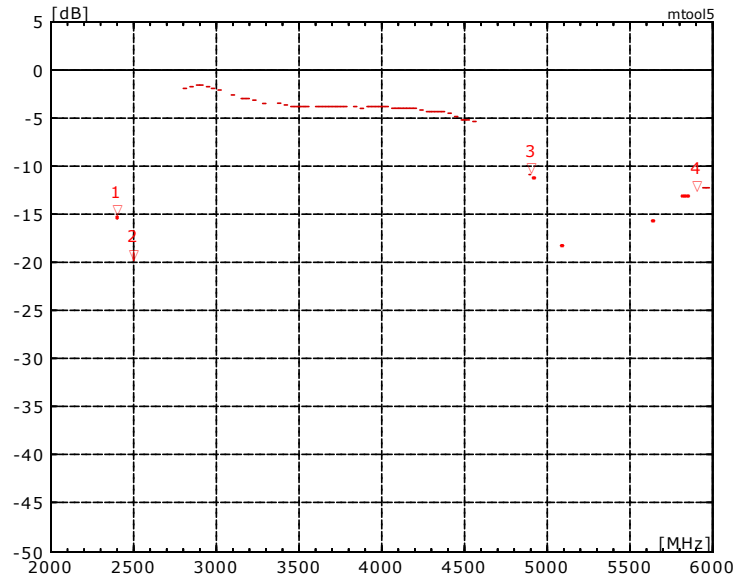

7-2 VSWR

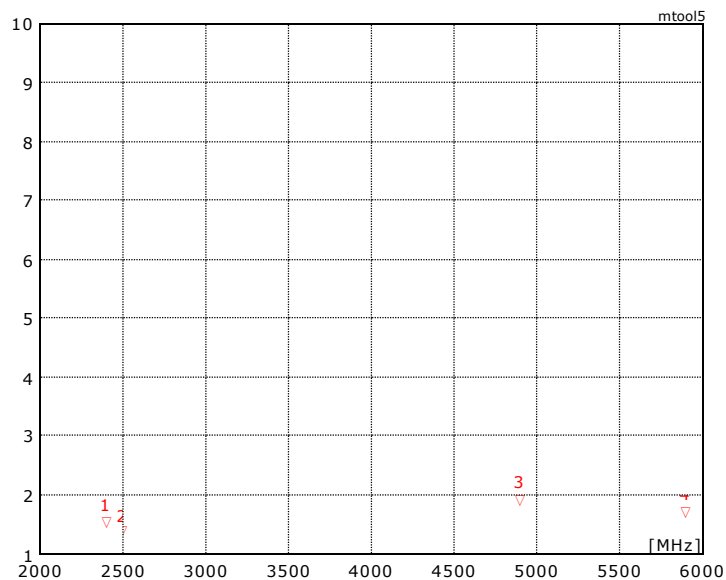

7-3 Antenna patterns

7.3.1. 2400 MHz – 2500 MHz

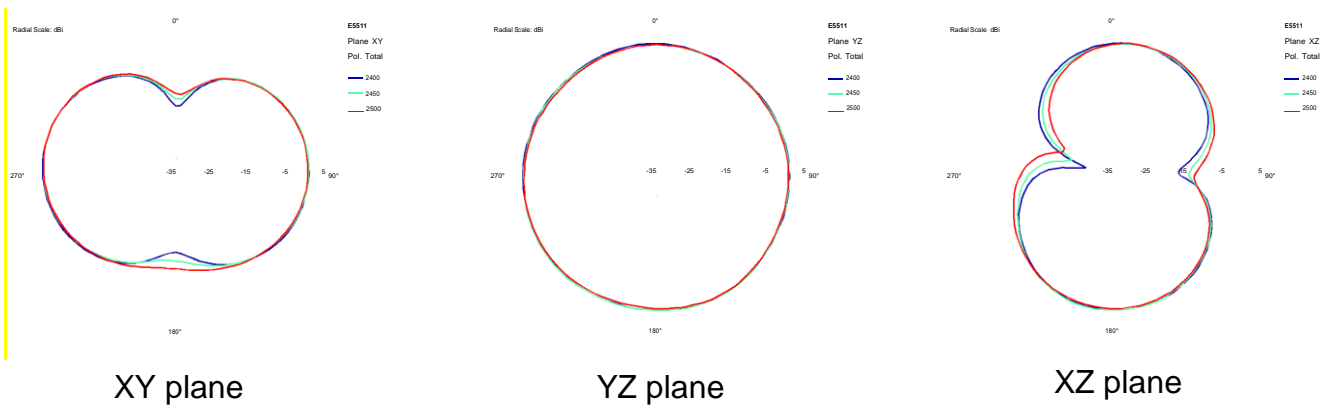
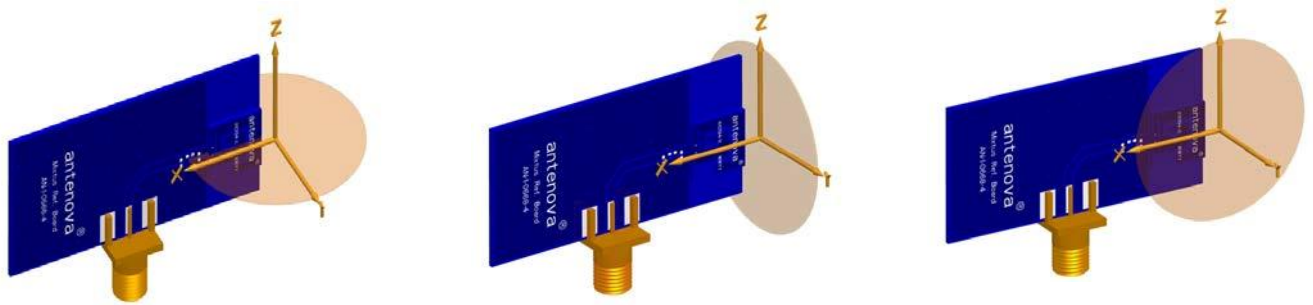
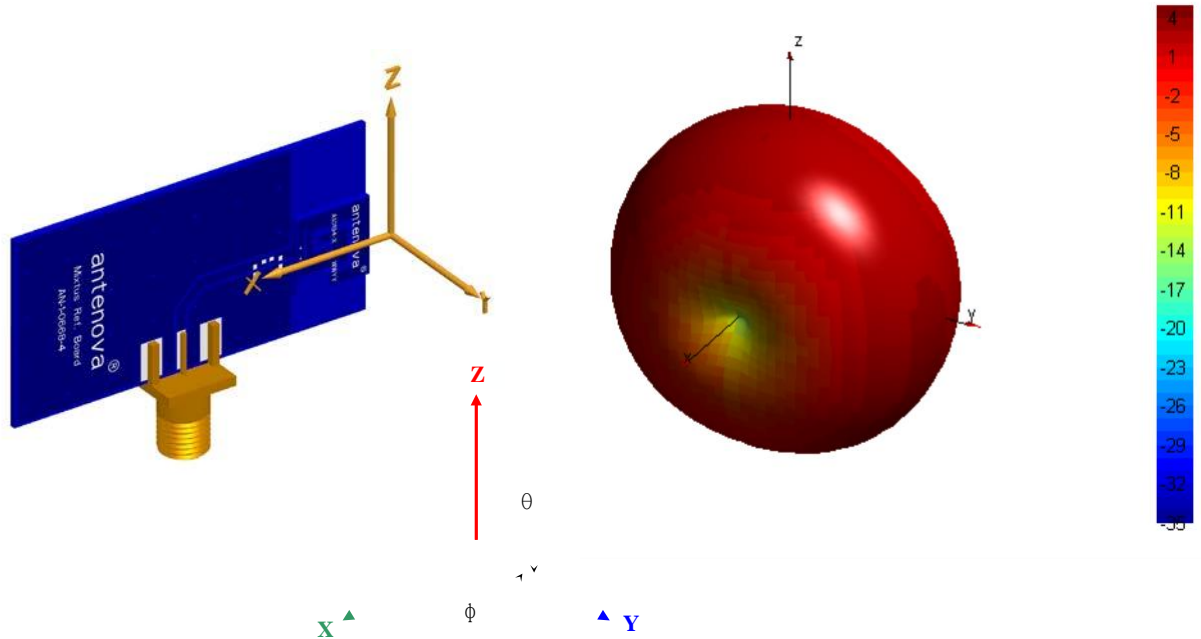

Patterns show combined polarisations
measured on reference board A10194-U1

7.3.2. 4900 MHz – 5900 MHz

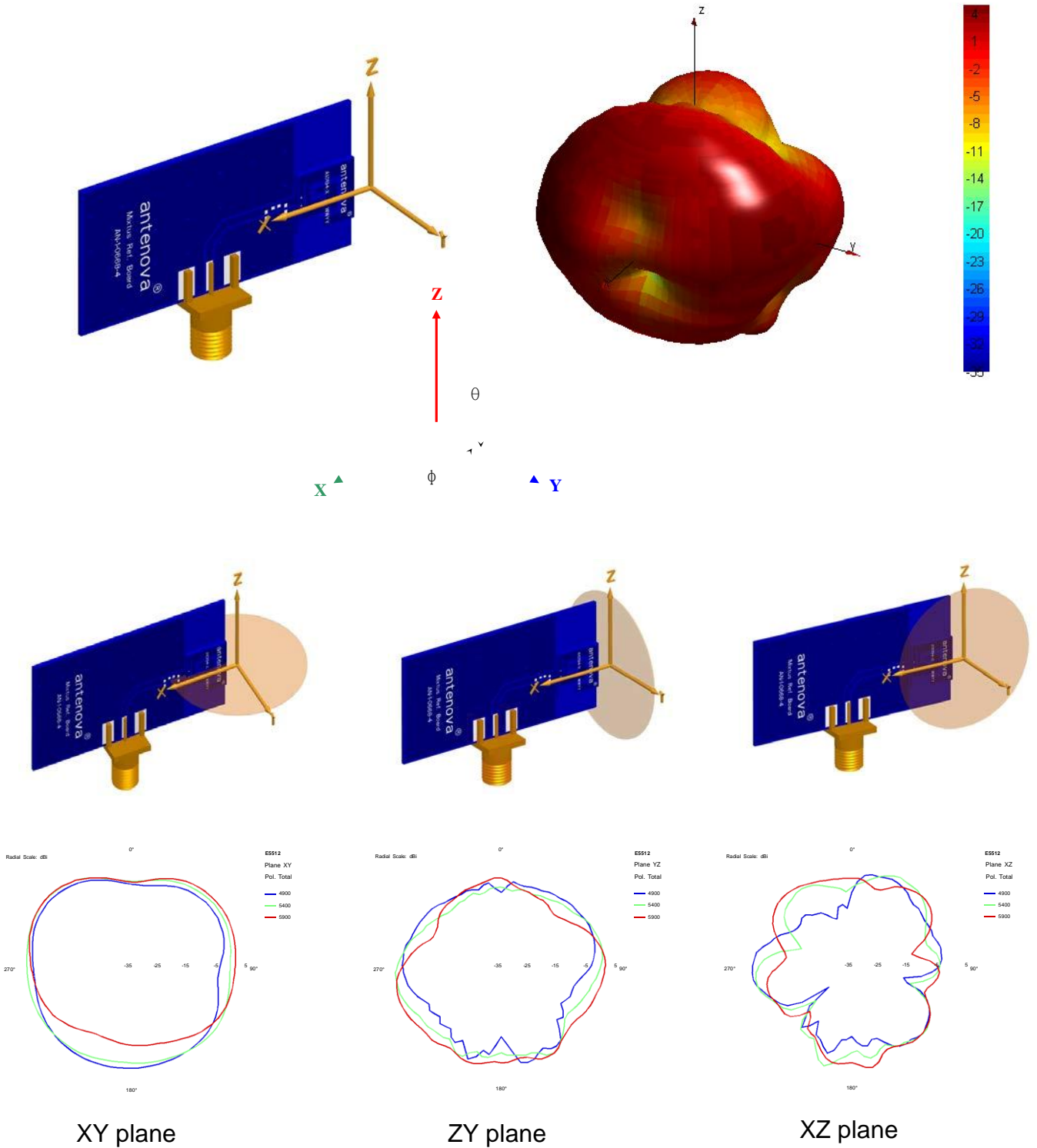

Patterns show combined polarisations
measured on reference board A10194-U1

8 Antenna dimensions

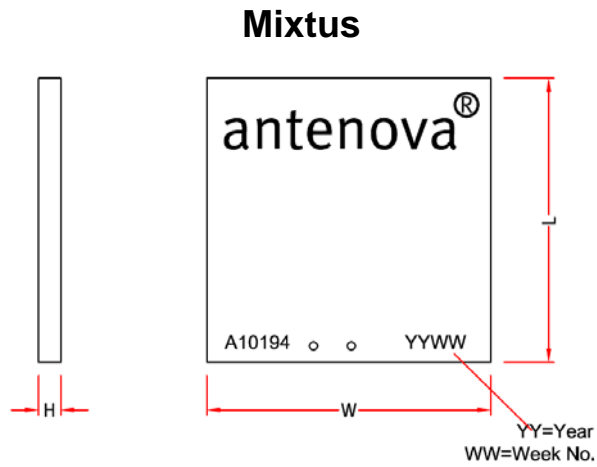

L	W	H
Length	Width	Height
10.4 ± 0.2	10.4 ± 0.2	0.8 ± 0.15

Dimensions in mm

9 Antenna footprint

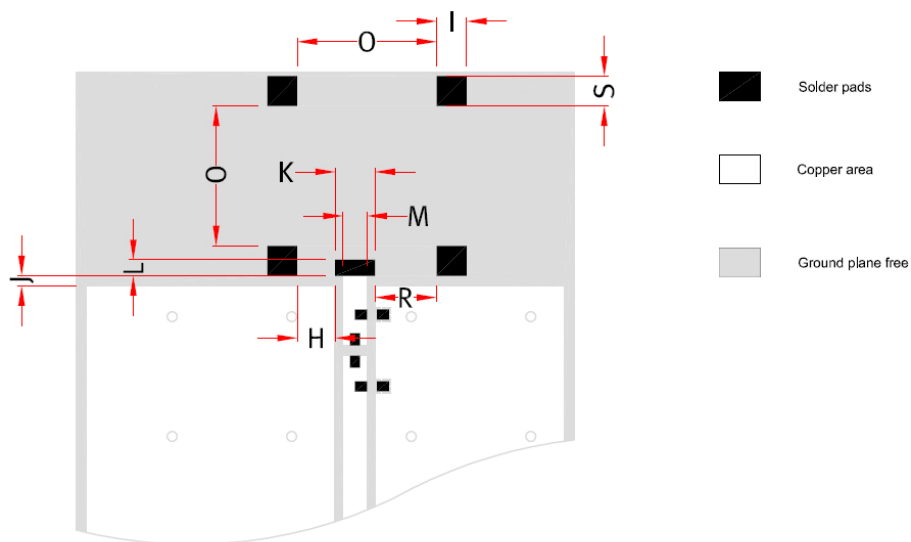

Mixtus (Part No: A10194)

CAD files of the antenna footprint are available to download at www.antenna-m2m.com

I	S	K	J	M	O	H	R	L
1.5 ± 0.1	1.5 ± 0.1	2.0 ± 0.1	0.5 ± 0.1	1.2 ± 0.1	7.0 ± 0.1	1.9 ± 0.1	3.1 ± 0.1	0.8 ± 0.1

Dimensions in mm

10 Electrical interface

10-1 Transmission lines

- All transmission lines should be designed to have a characteristic impedance of 50Ω
- The length of the transmission lines should be kept to a minimum.
- Any other parts of the RF system like transceivers, power amplifiers, etc, should also be designed to have an impedance of 50Ω

Once the material for the PCB has been chosen (PCB thickness and dielectric constant), a coplanar transmission line can easily be designed using any of the commercial software packages for transmission line design. For the chosen PCB thickness, copper thickness and substrate dielectric constant, the program will calculate the appropriate transmission line width and gaps on either side of the track so the characteristic impedance of the coplanar transmission line is 50Ω .

10-2 Matching circuit

The antenna requires a matching circuit that must be optimized for each customer's product. The matching circuit will require up to three components and the following pad layout should be designed into the device so the correct circuit can be installed:

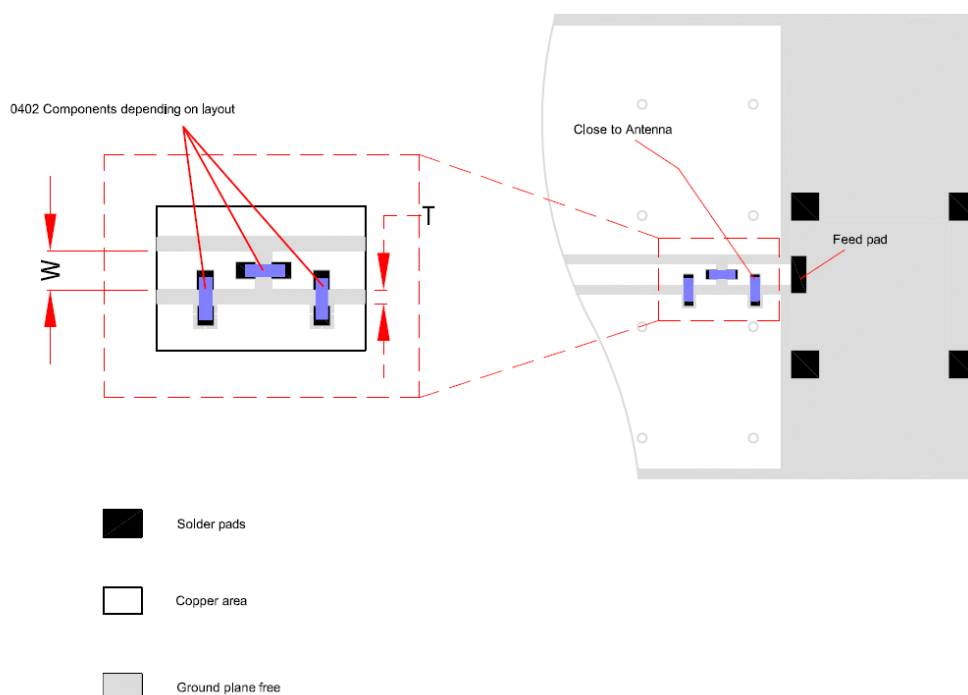

The antenna feed pad and the antenna ground pad are indicated in the drawing above. Additional pads are for mechanical attachment only and should not be grounded.

In addition to the matching circuit, a separate DC blocking capacitor will also be required between the radio and the antenna matching circuit.

Note: The component values for the matching circuit will vary depending on the size of the PCB and surrounding components. The impedance of the antenna should be measured before selecting suitable matching components. Antenova M2M offers this service on request. Contact sales@antenova-m2m.com for further information.

10-3 Antenna placement

Antenova M2M strongly recommends placing the antenna near the edge of the board. Maximum antenna performance is achieved by placing the antenna towards one of the corners of the PCB and with the feed point of the antenna as close to the same corner of the PCB as possible.

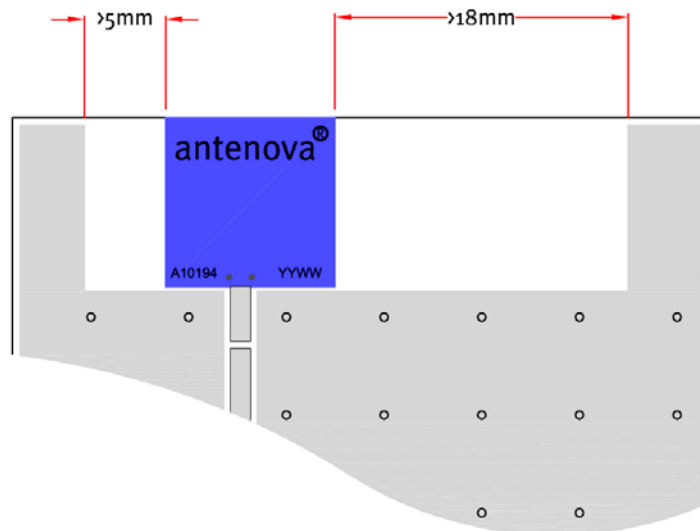

Additional ground and components near the antenna should be at a distance of at least 5 mm from the left hand side and 18 mm or more from the right hand side as shown in the drawing above.

10-4 Reference boards

The reference boards have been designed for evaluation purposes of Mixtus dual-band Wi-Fi SMD antenna and they include a SMA female connector

Mixtus

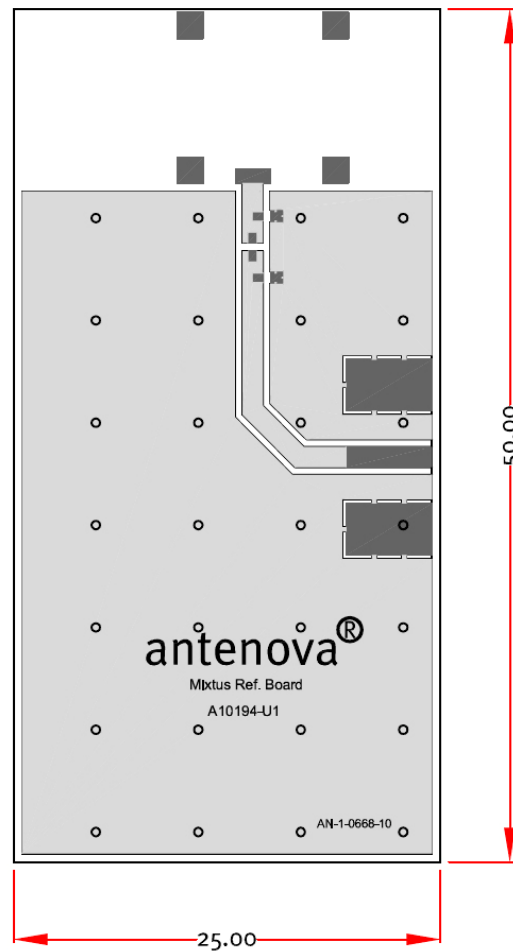

Dimensions in mm

To order a reference board contact sales@antenna-m2m.com.

11 Soldering

This antenna is suitable for lead free soldering.

The reflow profile should be adjusted to suit the PCBA, oven and solder paste, while observing the following conditions:

RECOMMENDED CONDITION OF REFLOW SOLDERING

- 1.Pre Heating Rate : 1 to 5 deg./s
- 2.Pre Liminary Heating : 130 to 170 deg. ,
50 to 120s
- 3.Reflow Heating Rate : 1 to 5 deg./s
- 4.Soldering : 230 deg. , 20 to 30s
- 5.Peak Temperature : 245 to 260 deg. ,
10s Max.
- 6.Cooling : 60s Min.
- 7.Number of Reflow Soldering : 2 times Max.

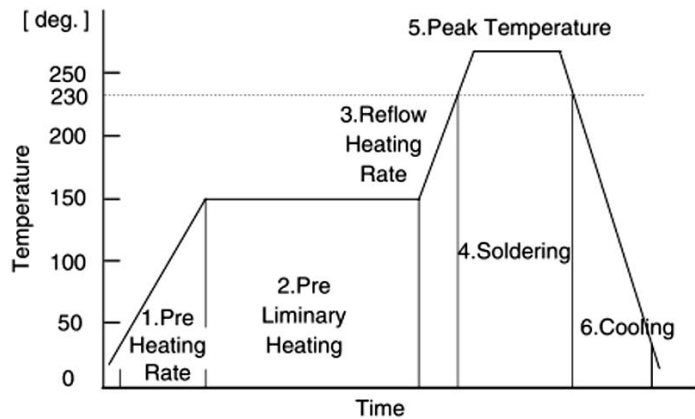

* Recommended peak temperature is over 245 degree. If peak temperature is below 245 degree., you may adjust the following parameters ; Time length of peak temperature (longer), Time length of soldering (longer), Thickness of solder paste (thicker).

12 Hazardous material regulation conformance

The antenna has been tested to conform to RoHS requirements. A certificate of conformance is available from Antenova M2M's website.

13 Packaging

13-1 Optimal storage conditions for packaged reels

Temperature	-10°C to 40°C
Humidity	Less than 75% RH
Shelf Life	18 Months
Storage place	Away from corrosive gas and direct sunlight
Packaging	Reels should be stored in unopened sealed manufacturer's plastic packaging.

Note: Storage of open reels of antennas is not recommended due to possible oxidization of pads on antennas. If short term storage is necessary, then it is highly recommended that the bag containing the antenna reel is re-sealed and stored in like storage conditions as in above table.

13-2 Tape characteristics

Mixtus
[Part Number: A10194]

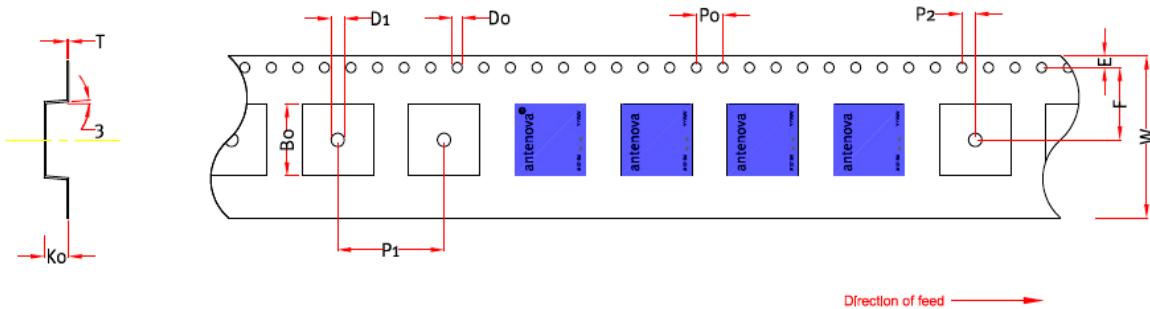

W	F	E	P0	P1	P2	B0	K0	T	D0	D1
24 ± 0.2	10.7 ± 0.1	1.75 ± 0.1	4.0 ± 0.1	16.0 ± 0.1	2.0 ± 0.1	10.7 ± 0.1	1.1 ± 0.1	0.3 ± 0.05	Min 1.55 ± 0.1	Min 2.0 ± 0.2

Dimensions in mm

Quantity	Leading Space	Trailing Space
2000 pcs / reel	50 blank antenna holders	50 blank antenna holders

13-3 Reel dimensions

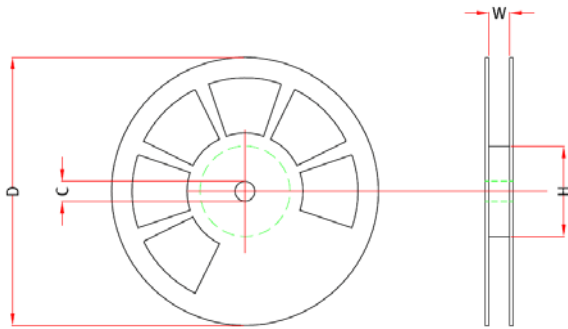

Width (W)	Reel Diameter (D)	Hub Diameter (H)	Shaft Diameter (C)
57.5 mm	330 mm ± 2.0	80 mm (2")	13.0 mm ± 0.5

13-4 Box dimensions

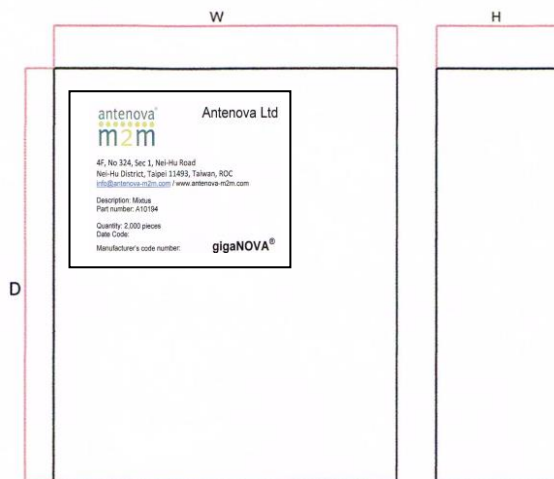

Width (W)	Breadth (B)	Thickness (H)
338 mm	335 mm	45 mm

13-5 Bag properties

Reels are supplied in protective plastic packaging

13-6 Reel label information

Mixtus

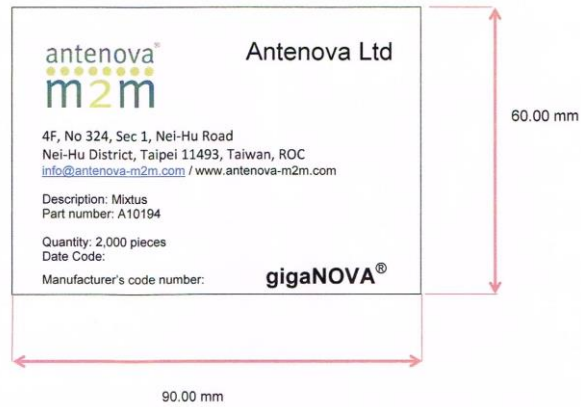

Dimensions in mm



www.antenova-m2m.com

Corporate Headquarters

Antenova Ltd.
2nd Floor, Titan Court
3 Bishop Square
Hatfield
AL10 9NA

North America Headquarters

Antenova Ltd.
100 Brush Creek Road, Suite 103
Santa Rosa
California, 95404
USA

Asia Headquarters

Antenova Asia Ltd.
4F, No. 324, Sec. 1, Nei-Hu Road
Nei-Hu District
Taipei 11493
Taiwan, ROC

Tel: +44 1223 810600
Email: sales@antenova-m2m.com

Tel: +1 707 890 5202
Email: sales@antenova-m2m.com

Tel: +886 (0) 2 8797 8630
Fax: +886 (0) 2 8797 6890
Email: sales@antenova-m2m.com

Copyright® Antenova Ltd. All Rights Reserved. Antenova®, Antenova M2M®, gigaNOVA®, the Antenova product family names, and the Antenova and Antenova M2M logos are trademarks and/or registered trademarks of Antenova Ltd. Any other names and/or trademarks belong to their respective companies.

The materials provided herein are believed to be reliable and correct at the time of print. Antenova does not warrant the accuracy or completeness of the information, text, graphics or other items contained within these information. Antenova further assumes no responsibility for the use of this information, and all such information shall be entirely at the user's risk.



Certificate No: 4598

Antennas for Wireless M2M Applications

Компания «Океан Электроники» предлагает заключение долгосрочных отношений при поставках импортных электронных компонентов на взаимовыгодных условиях!

Наши преимущества:

- Поставка оригинальных импортных электронных компонентов напрямую с производств Америки, Европы и Азии, а так же с крупнейших складов мира;
- Широкая линейка поставок активных и пассивных импортных электронных компонентов (более 30 млн. наименований);
- Поставка сложных, дефицитных, либо снятых с производства позиций;
- Оперативные сроки поставки под заказ (от 5 рабочих дней);
- Экспресс доставка в любую точку России;
- Помощь Конструкторского Отдела и консультации квалифицированных инженеров;
- Техническая поддержка проекта, помощь в подборе аналогов, поставка прототипов;
- Поставка электронных компонентов под контролем ВП;
- Система менеджмента качества сертифицирована по Международному стандарту ISO 9001;
- При необходимости вся продукция военного и аэрокосмического назначения проходит испытания и сертификацию в лаборатории (по согласованию с заказчиком);
- Поставка специализированных компонентов военного и аэрокосмического уровня качества (Xilinx, Altera, Analog Devices, Intersil, Interpoint, Microsemi, Actel, Aeroflex, Peregrine, VPT, Syfer, Eurofarad, Texas Instruments, MS Kennedy, Miteq, Cobham, E2V, MA-COM, Hittite, Mini-Circuits, General Dynamics и др.);

Компания «Океан Электроники» является официальным дистрибьютором и эксклюзивным представителем в России одного из крупнейших производителей разъемов военного и аэрокосмического назначения «JONHON», а так же официальным дистрибьютором и эксклюзивным представителем в России производителя высокотехнологичных и надежных решений для передачи СВЧ сигналов «FORSTAR».



JONHON

«JONHON» (основан в 1970 г.)

Разъемы специального, военного и аэрокосмического назначения:

(Применяются в военной, авиационной, аэрокосмической, морской, железнодорожной, горно- и нефтедобывающей отраслях промышленности)

«FORSTAR» (основан в 1998 г.)

ВЧ соединители, коаксиальные кабели, кабельные сборки и микроволновые компоненты:

(Применяются в телекоммуникациях гражданского и специального назначения, в средствах связи, РЛС, а так же военной, авиационной и аэрокосмической отраслях промышленности).



Телефон: 8 (812) 309-75-97 (многоканальный)

Факс: 8 (812) 320-03-32

Электронная почта: ocean@oceanchips.ru

Web: <http://oceanchips.ru/>

Адрес: 198099, г. Санкт-Петербург, ул. Калинина, д. 2, корп. 4, лит. А