

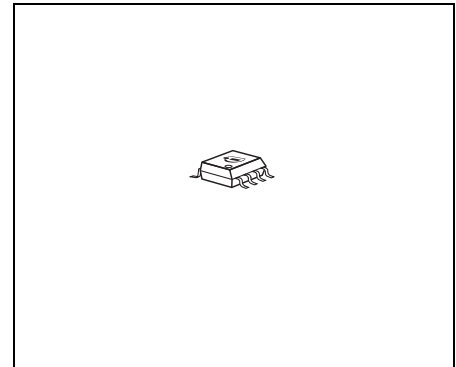

Features

- Step down converter
- Supply Over- and Under-Voltage-Lockout
- Low Output voltage tolerance
- Output Overvoltage Lockout
- Output Under-Voltage-Reset with delay
- Overtemperature Shutdown
- Wide Ambient operation range -40 °C to 125 °C
- Wide Supply voltage operation range
- Very low current consumption
- Very small PG-DSO-8 SMD package
- Green Product (RoHS compliant)
- AEC Qualified



Functional Description

The **TLE 6365 G** is a power supply circuit especially designed for automotive applications.

The device is based on Infineon's power technology SPT[®] which allows bipolar and CMOS control circuitry to be integrated with DMOS power devices on the same monolithic circuitry.

The **TLE 6365 G** contains a buck converter and a power on reset feature to start up the system

The very small **PG-DSO-8** SMD package meets the application requirements.

It delivers a precise 5 V fully short circuit protected output voltage.

Furthermore, the build-in features like under- and overvoltage lockout for supply- and output-voltage and the overtemperature shutdown feature increase the reliability of the **TLE 6365 G** supply system.

Type	Package	Marking
TLE 6365 G	PG-DSO-8	6365G

Pin Configuration

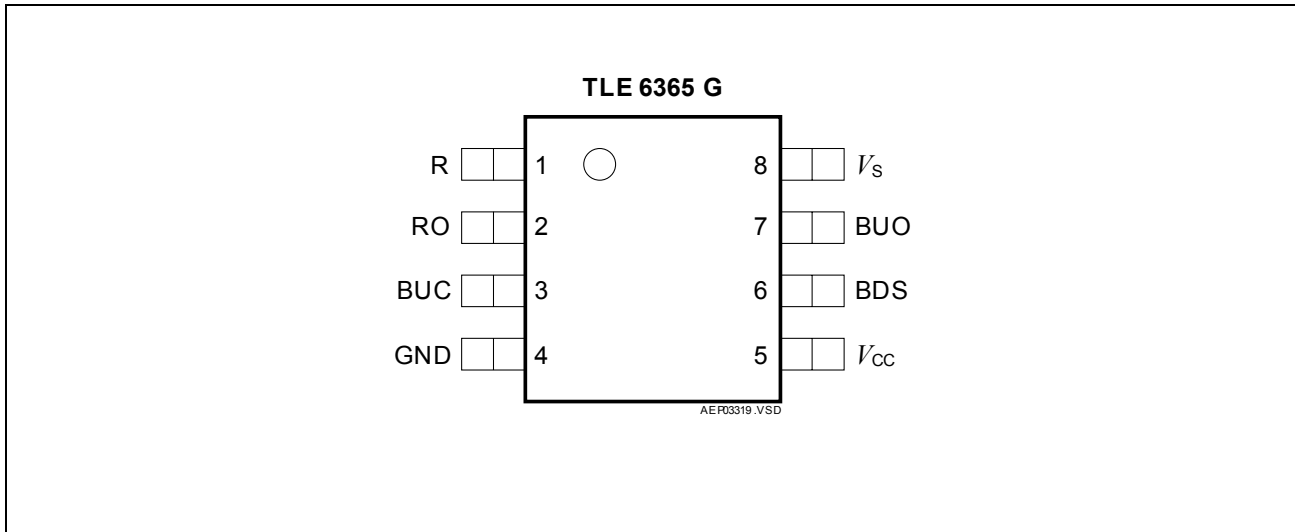

Figure 1 Pin Configuration (top view)

Table 1 Pin Definitions and Functions

Pin No.	Symbol	Function
1	R	Reference Input; an external resistor from this pin to GND determines the reference current and so the oscillator / switching frequency.
2	RO	Reset Output; open drain output from reset comparator with an internal pull-up resistor
3	BUC	Buck-Converter Compensation Input; output of internal error amplifier; for loop-compensation and therefore stability connect an external <i>R-C</i> -series combination to GND.
4	GND	Ground; analog signal ground
5	V_{CC}	Output Voltage Input; feedback input (with integrated resistor divider) and logic supply input; external blocking capacitor necessary
7	BUO	Buck Converter Output; source of the integrated power-DMOS
6	BDS	Buck Driver Supply Input; voltage to drive the buck converter powerstage
8	V_S	Supply Voltage Input; buck converter input voltage; external blocking capacitor necessary.

Block Diagram

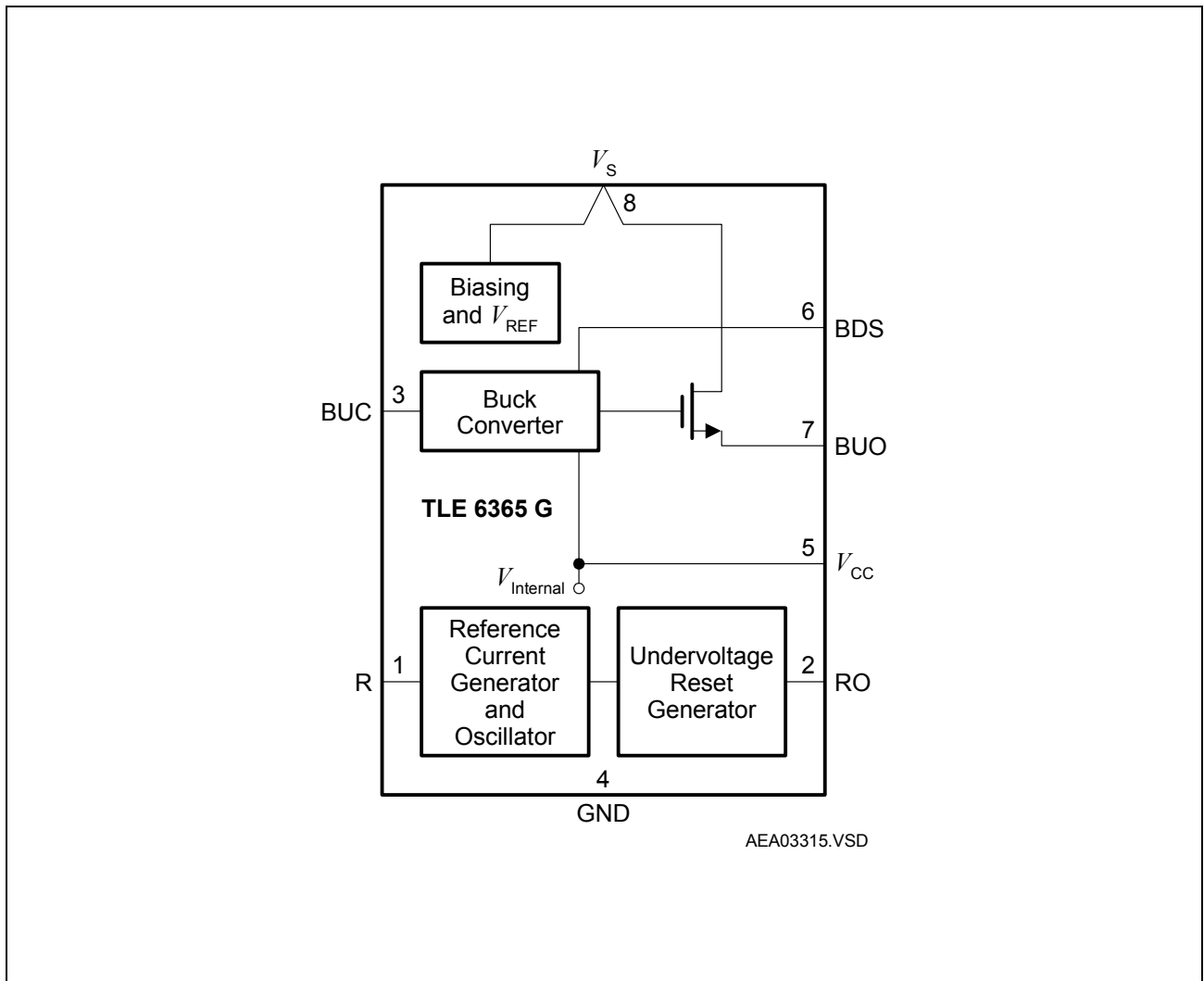

Figure 2 Block Diagram

Table 2 Absolute Maximum Ratings

Parameter	Symbol	Limit Values		Unit	Remarks
		Min.	Max.		
Voltages					
Supply voltage	V_S	-0.3	46	V	–
Buck output voltage	V_{BUO}	-1	46	V	–
Buck driver supply voltage	V_{BDS}	-0.3	48	V	$0^{\circ}\text{C} \leq T_j \leq 150^{\circ}\text{C}$
		-0.3	47	V	$-40^{\circ}\text{C} \leq T_j < 0^{\circ}\text{C}$
Buck compensation input voltage	V_{BUC}	-0.3	6.8	V	–
Logic supply voltage	V_{CC}	-0.3	6.8	V	–
Reset output voltage	V_{RO}	-0.3	6.8	V	–
Current reference voltage	V_R	-0.3	6.8	V	–
ESD-Protection (Human Body Model; $R = 1.5 \text{ k}\Omega$; $C = 100 \text{ pF}$)					
All pins to GND	V_{HBM}	-2	2	kV	–
Temperatures					
Junction temperature	T_j	-40	150	$^{\circ}\text{C}$	–
Storage temperature	T_{stg}	-50	150	$^{\circ}\text{C}$	–

Note: Stresses above those listed here may cause permanent damage to the device. Exposure to absolute maximum rating conditions for extended periods may affect device reliability.

Table 3 Operating Range

Parameter	Symbol	Limit Values		Unit	Remarks
		Min.	Max.		
Supply voltage	V_S	-0.3	40	V	–
Supply voltage	V_S	5	35	V	V_S increasing
Supply voltage	V_S	4.5	36	V	V_S decreasing
Supply voltage	V_S	-0.3	4.5	V	Buck-Converter OFF
Buck output voltage	V_{BUO}	-0.6	40	V	–
Buck driver supply voltage	V_{BDS}	-0.3	48	V	$0^{\circ}\text{C} \leq T_j \leq 150^{\circ}\text{C}$
		-0.3	47	V	$-40^{\circ}\text{C} \leq T_j < 0^{\circ}\text{C}$
Buck compensation input voltage	V_{BUC}	0	3.0	V	–
Logic supply voltage	V_{CC}	4.0	6.2	V	–
Reset output voltage	V_{RO}	-0.3	$V_{CC} + 0.3$	V	–
Current reference voltage	V_{CREF}	0	1.23	V	–
Junction temperature	T_j	-40	150	$^{\circ}\text{C}$	–
Thermal Resistance					
Junction ambient	R_{thj-a}	–	180	K/W	–

Table 4 Electrical Characteristics

8 V < V_S < 35 V; 4.75 V < V_{CC} < 5.25 V; -40 °C < T_j < 150 °C; $R_R = 47$ k Ω ; all voltages with respect to ground; positive current defined flowing into the pin; unless otherwise specified

Parameter	Symbol	Limit Values			Unit	Test Condition
		Min.	Typ.	Max.		
Current Consumption						
Current consumption; see Figure 6	I_S	–	1.5	4	mA	$I_{CC} = 0$ mA
Current consumption; see Figure 6	I_S	–	5	10	mA	$I_{CC} = 400$ mA
Under- and Over-Voltage Lockout at V_S						
UV ON voltage; buck conv. ON	V_{SUVON}	4.0	4.5	5.0	V	V_S increasing
UV OFF voltage; buck conv. OFF	V_{SUVOFF}	3.5	4.0	4.5	V	V_S decreasing
UV Hysteresis voltage	V_{SUVHY}	0.2	0.5	1.0	V	HY = ON - OFF
OV OFF voltage; buck conv. OFF	V_{SOVOFF}	34	37	40	V	V_S increasing
OV ON voltage; buck conv. ON	V_{SOVON}	30	33	36	V	V_S decreasing
OV Hysteresis voltage	V_{SUVHY}	1.5	4	10	V	HY = OFF - ON
Over-Voltage Lockout at V_{CC}						
OV OFF voltage; buck conv. OFF	$V_{CCOVOFF}$	5.5	6.0	6.5	V	V_{CC} increasing
OV ON voltage; buck conv. ON	V_{CCOVON}	5.25	5.75	6.25	V	V_{CC} decreasing
OV Hysteresis voltage	V_{CCOVHY}	0.10	0.25	0.50	V	HY = OFF - ON

Table 4 Electrical Characteristics (cont'd)

8 V < V_S < 35 V; 4.75 V < V_{CC} < 5.25 V; -40 °C < T_j < 150 °C; $R_R = 47\text{ k}\Omega$; all voltages with respect to ground; positive current defined flowing into the pin; unless otherwise specified

Parameter	Symbol	Limit Values			Unit	Test Condition
		Min.	Typ.	Max.		
Buck-Converter; BUO, BDS, BUC and V_{CC}						
Logic supply voltage	V_{CC}	4.9	–	5.1	V	1 mA < I_{CC} < 400 mA; see Figure 6
Efficiency; see Figure 6	η	–	85	–	%	$I_{CC} = 400\text{ mA}$; $V_S = 14\text{ V}$
Power-Stage ON resistance	R_{BUON}	–	0.38	0.5	Ω	$T_j = 25\text{ }^\circ\text{C}$; $I_{BUO} = 0.6\text{ A}$
Power-Stage ON resistance	R_{BUON}	–	–	1.0	Ω	$I_{BUO} = 0.6\text{ A}$
Buck overcurrent threshold	I_{BUOC}	0.7	0.9	1.2	A	–
Input current on pin V_{CC}	I_{CC}	–	–	500	μA	$V_{CC} = 5\text{ V}$
Buck Gate supply voltage; $V_{BGS} = V_S - V_{BDS}$	V_{BGS}	5	7.2	10	V	–
Reference Input; R (Oscillator; Timebase for Buck-Converter and Reset)						
Voltage on pin R	V_R	–	1.4	–	V	$R_R = 100\text{ k}\Omega$
Oscillator frequency	f_{OSC}	85	95	105	kHz	$T_j = 25\text{ }^\circ\text{C}$
Oscillator frequency	f_{OSC}	75	–	115	kHz	–
Cycle time for reset timing	t_{CYL}	–	1	–	ms	$t_{CYL} = 100 / f_{OSC}$

Table 4 Electrical Characteristics (cont'd)

8 V < V_S < 35 V; 4.75 V < V_{CC} < 5.25 V; -40 °C < T_j < 150 °C; $R_R = 47$ k Ω ; all voltages with respect to ground; positive current defined flowing into the pin; unless otherwise specified

Parameter	Symbol	Limit Values			Unit	Test Condition
		Min.	Typ.	Max.		
Reset Generator; RO						
Reset threshold; V_{CC} decreasing	V_{RT}	4.50	4.65	4.75	V	V_{RO} H to L or L to H transition; V_{RO} remains low down to $V_{CC} > 1$ V
Reset low voltage	V_{ROL}	–	0.2	0.4	V	$I_{ROL} = 1$ mA; 2.5 V < $V_{CC} < V_{RT}$
Reset low voltage	V_{ROL}	–	0.2	0.4	V	$I_{ROL} = 0.2$ mA; 1 V < $V_{CC} < V_{RT}$
Reset high voltage	V_{ROH}	$V_{CC} - 0.1$	–	$V_{CC} + 0.1$	V	$I_{ROH} = 0$ mA
Reset pull-up current	I_{RO}	–	240	–	μ A	0 V < $V_{RO} < 4$ V
Reset Reaction time	t_{RR}	10	40	90	μ s	$V_{CC} < V_{RT}$
Power-up reset delay time	t_{RD}	–	128	–	t_{CYL}	$V_{CC} \geq 4.8$ V
Thermal Shutdown (Boost and Buck-Converter OFF)						
Thermal shutdown junction temperature	T_{jSD}	150	175	200	°C	–
Thermal switch-on junction temperature	T_{jSO}	120	–	170	°C	–
Temperature hysteresis	ΔT	–	30	–	K	–

Circuit Description

Below some important sections of the TLE 6365 are described in more detail.

Power On Reset

In order to avoid any system failure, a sequence of several conditions has to be passed. In case of V_{CC} power down ($V_{CC} < V_{RT}$ for $t > t_{RR}$) a logic LOW signal is generated at the pin RO to reset an external microcontroller. When the level of V_{CC} reaches the reset threshold V_{RT} , the signal at RO remains LOW for the Power-up reset delay time t_{RD} before switching to HIGH. If V_{CC} drops below the reset threshold V_{RT} for a time extending the reset reaction time t_{RR} , the reset circuit is activated and a power down sequence of period t_{RD} is initiated. The reset reaction time t_{RR} avoids wrong triggering caused by short “glitches” on the V_{CC} -line.

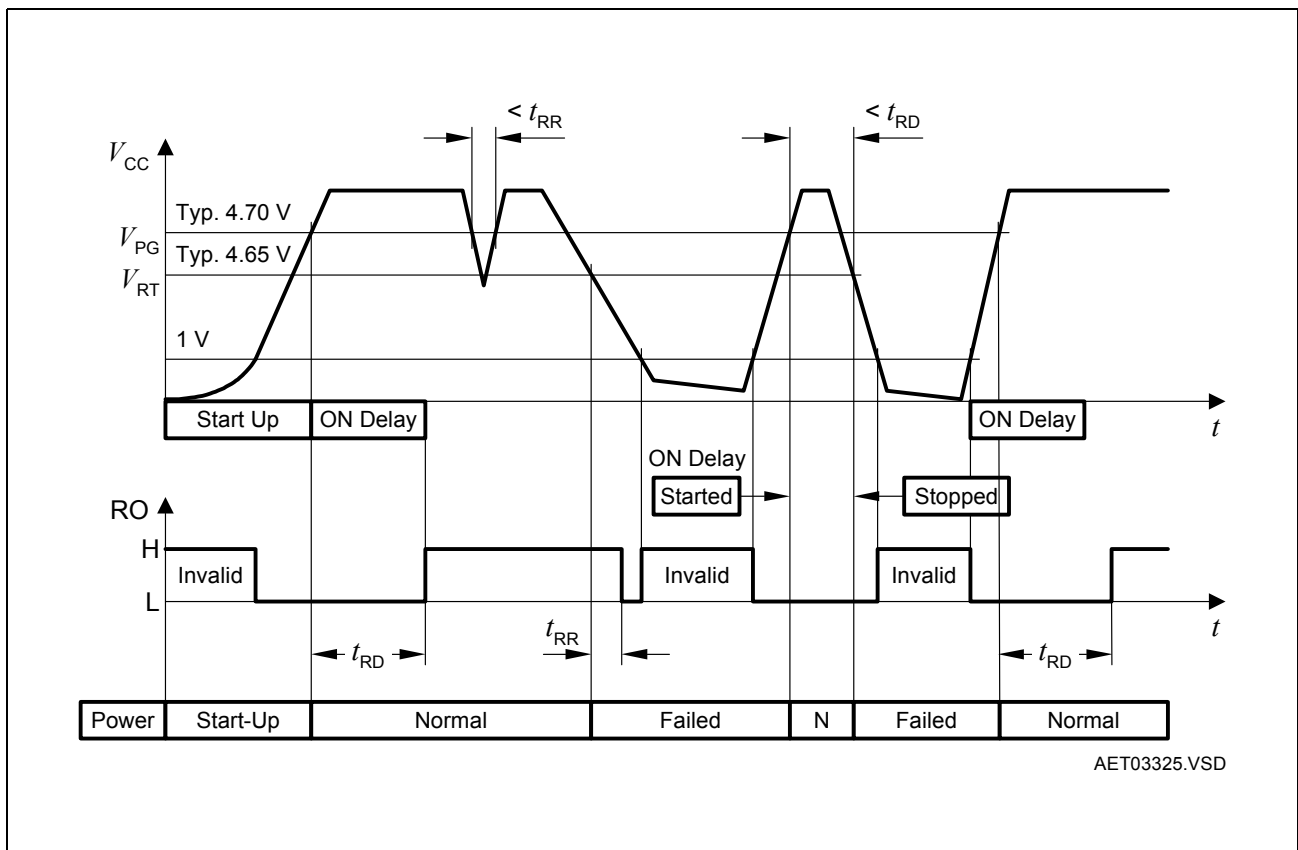

Figure 3 Reset Function

Buck Converter

A stabilized logic supply voltage (typ. 5 V) for general purpose is realized in the system by a buck converter. An external buck-inductance L_{BU} is PWM switched by a high side DMOS power transistor with the programmed frequency (pin R).

The buck converter uses the temperature compensated bandgap reference voltage (typ. 2.8 V) for its regulation loop.

This reference voltage is connected to the non-inverting input of the error amplifier and an internal voltage divider supplies the inverting input. Therefore the output voltage V_{CC} is fixed due to the internal resistor ratio to typ. 5.0 V.

The output of the error amplifier goes to the inverting input of the PWM comparator as well as to the buck compensation output BUC.

When the error amplifier output voltage exceeds the sawtooth voltage the output power MOS-transistor is switched on. So the duration of the output transistor conduction phase depends on the V_{CC} level. A logic signal PWM with variable pulse width is generated.

External loop compensation is required for converter stability, and is formed by connecting a compensation resistor-capacitor series-network (R_{BUC} , C_{BUC}) between pin BUC and GND.

In the case of overload or short-circuit at V_{CC} (the output current exceeds the buck overcurrent threshold I_{BUOC}) the DMOS output transistor is switched off by the overcurrent comparator immediately.

In order to protect the V_{CC} input as well as the external load against catastrophic failures, an overvoltage protection is provided which switches off the output transistor as soon as the voltage at pin V_{CC} exceeds the internal fixed overvoltage threshold $V_{CCOV\ OFF} = \text{typ. } 6.0 \text{ V}$.

Also a battery undervoltage protection is implemented in the **TLE 6365** to avoid wrong operation of the following supplied devices, the typical threshold when decreasing the battery voltage is at $V_{SUV\ OFF} = \text{typ. } 4.0 \text{ V}$.

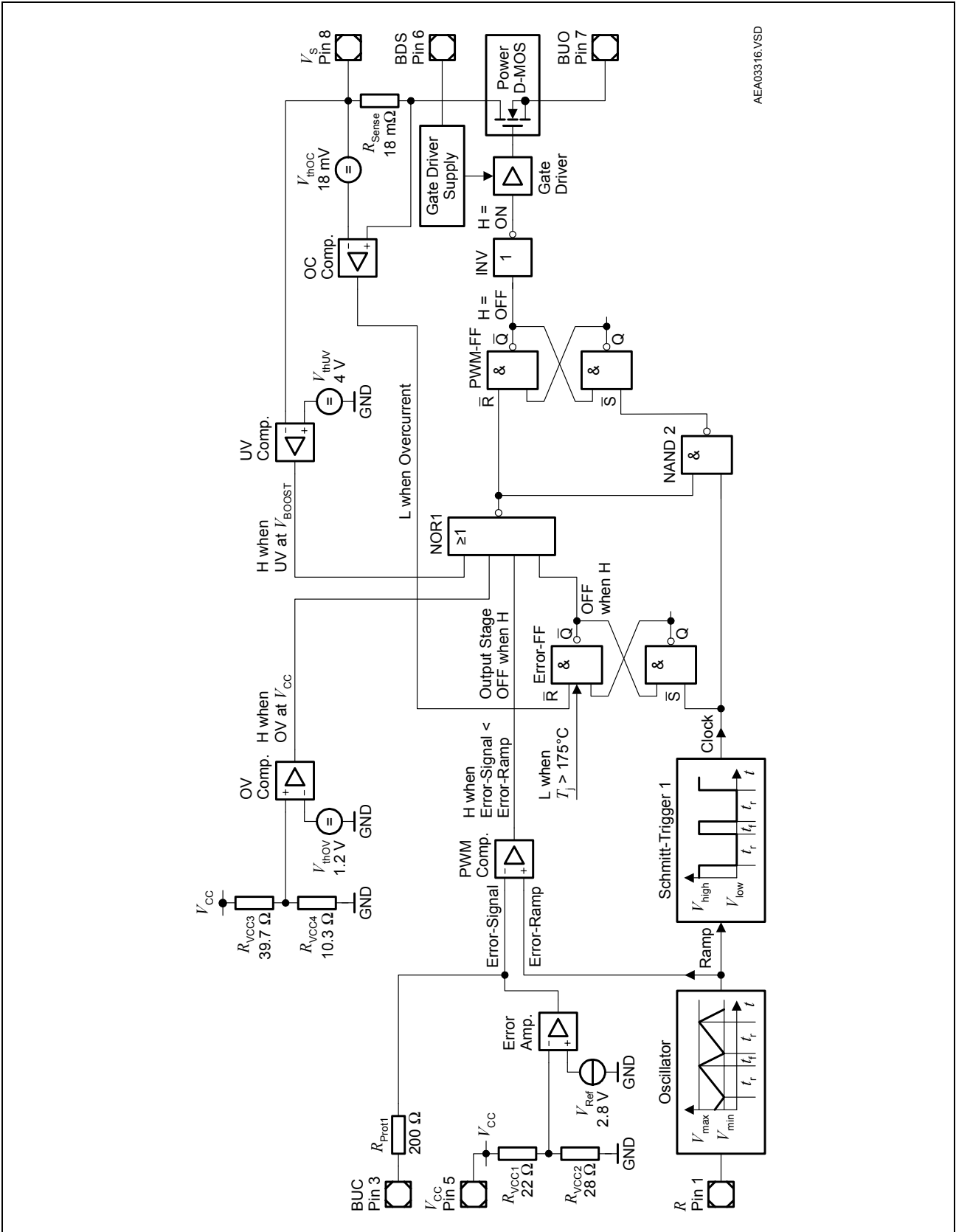

AEA03316.VSD

Figure 4 Buck Converter Block Diagram

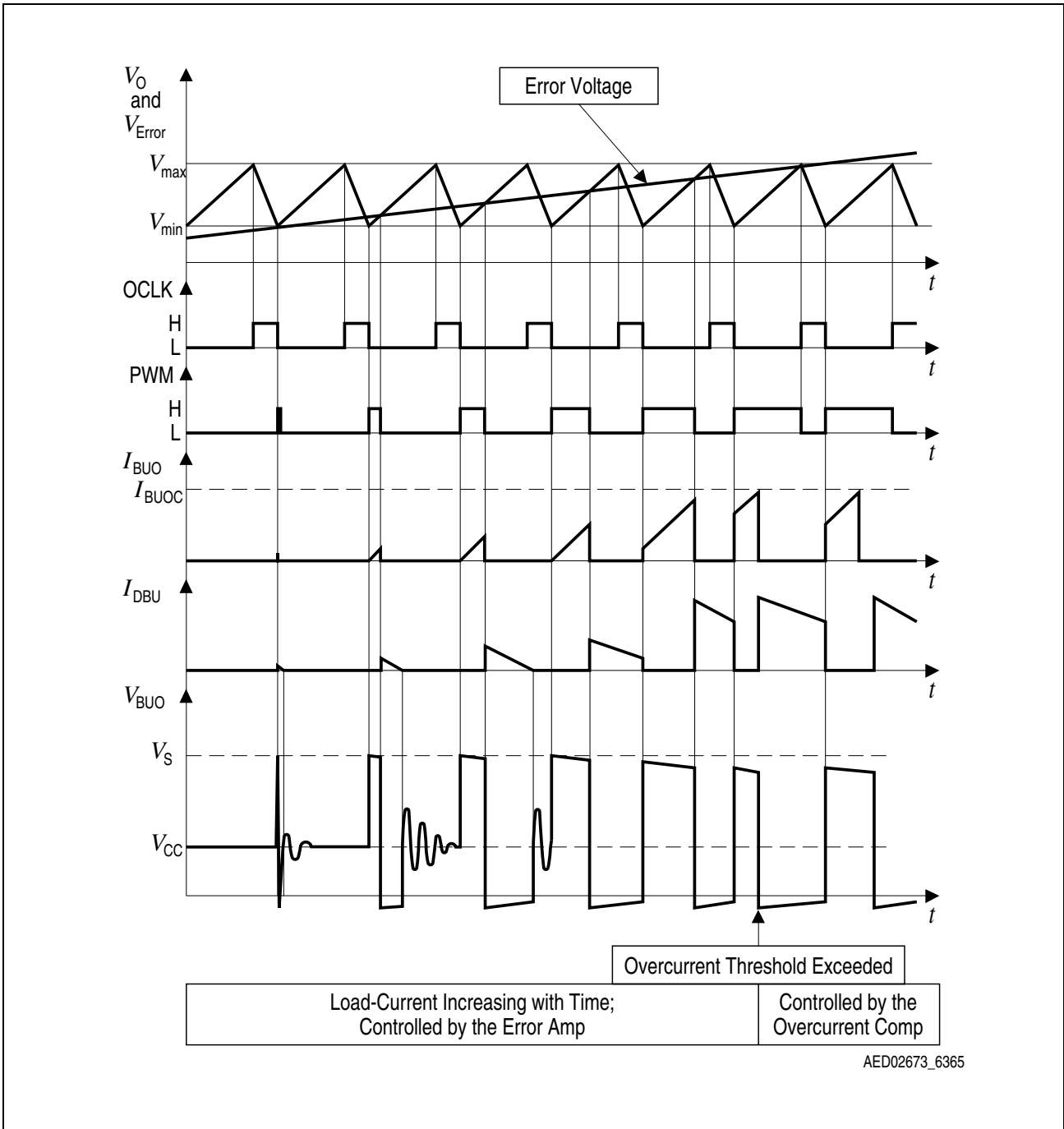

Figure 5 Most Important Waveforms of the Buck Converter Circuit

Application Circuit

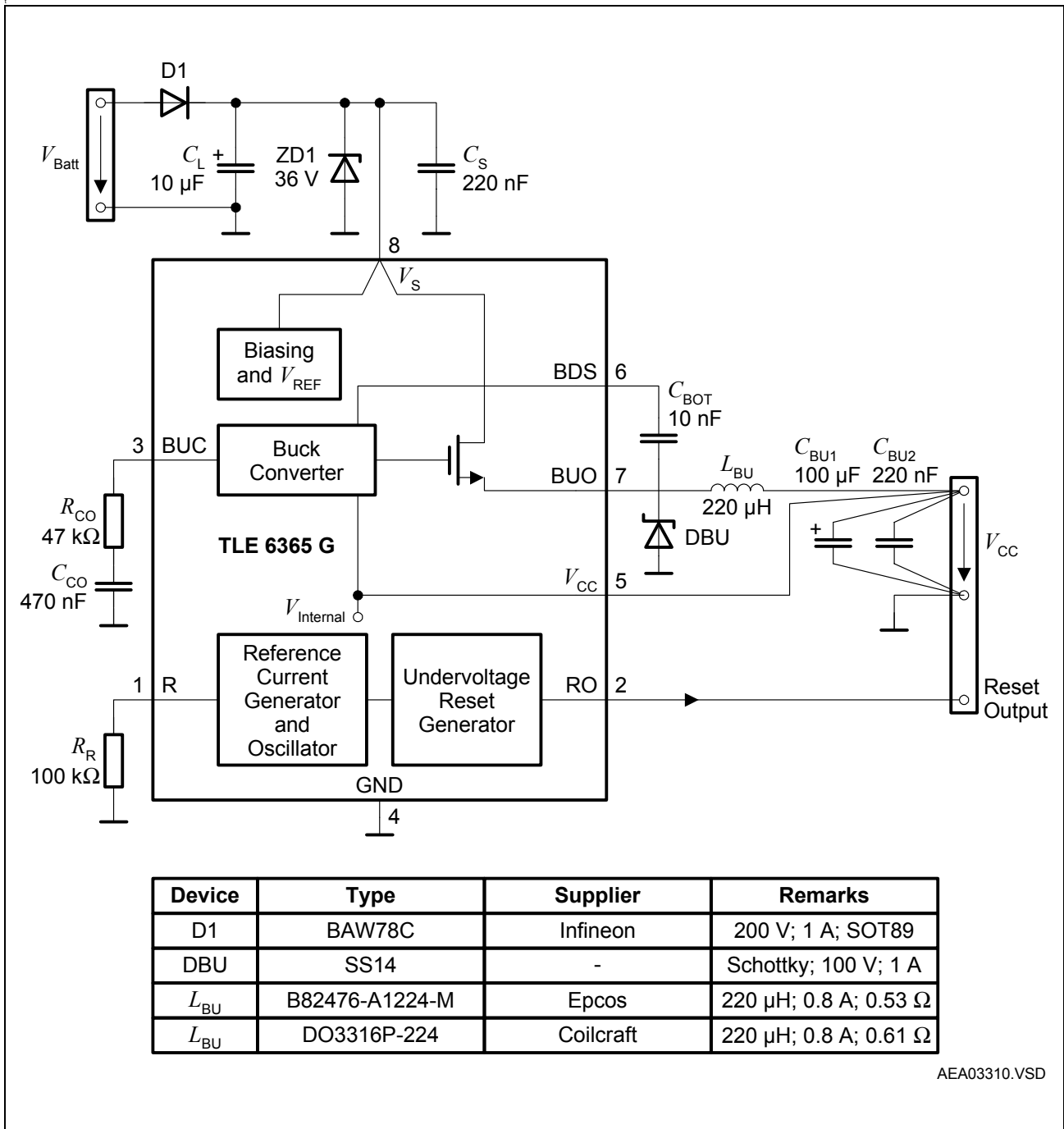
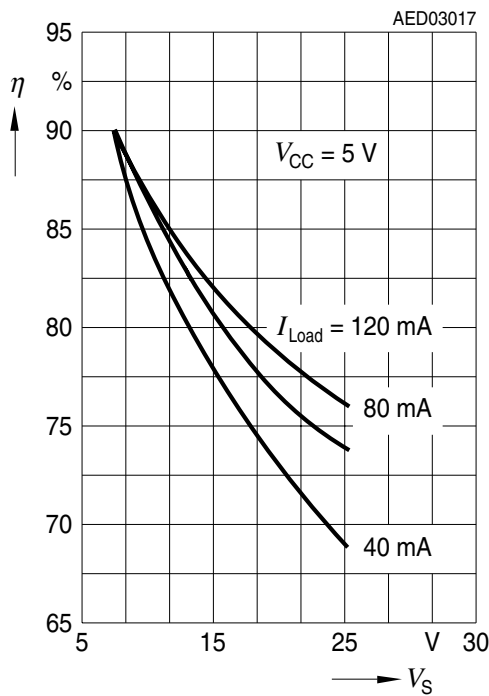

Figure 6 Application Circuit

Diagrams: Oscillator and Boost/Buck-Converter Performance

In the following the behaviour of the Boost/Buck-converter and the oscillator is shown.

Efficiency Buck vs. Boost Voltage



Oscillator Frequency Deviation vs. Junction Temperature

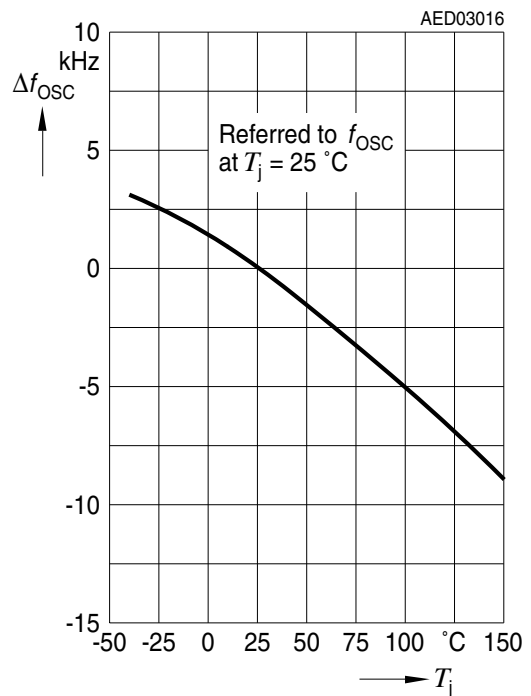

Feedback Voltage vs. Junction Temperature

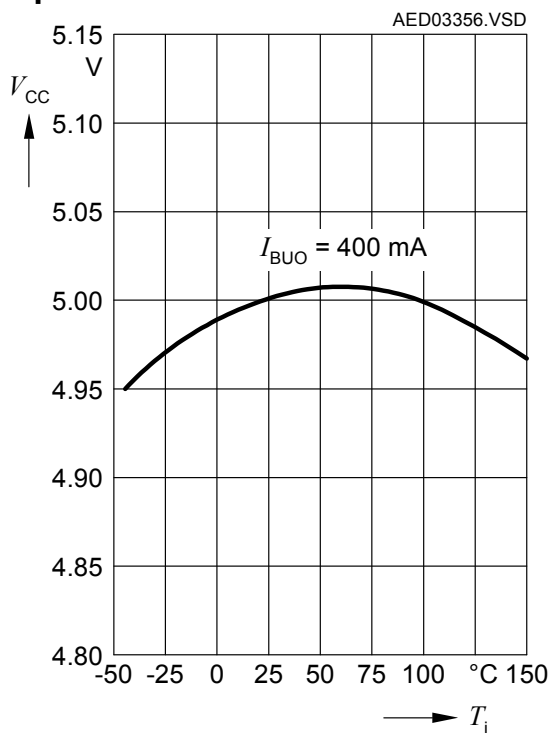

Buck Overcurrent Threshold vs. Junction Temperature

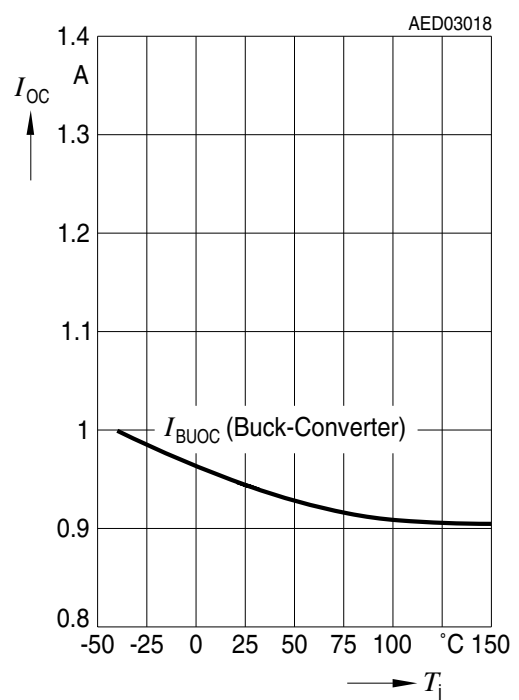

Current Consumption vs. Junction Temperature

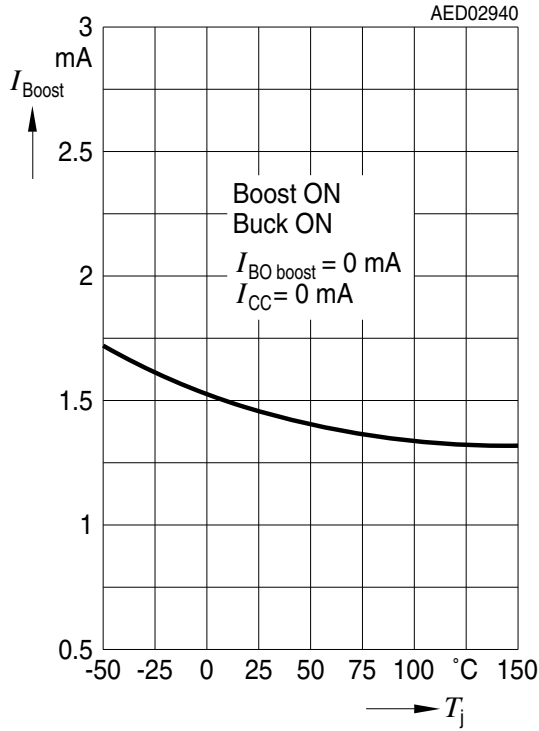

Oscillator Frequency vs. Resistor between R and GND

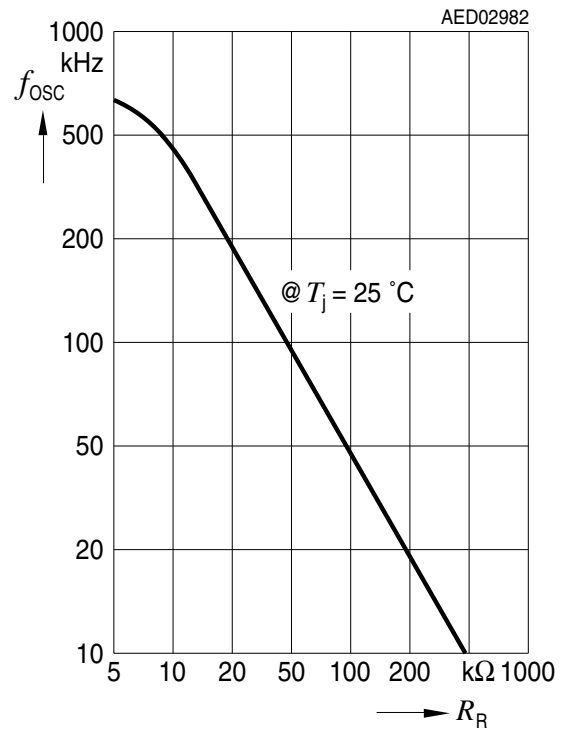

Efficiency Buck vs. Load

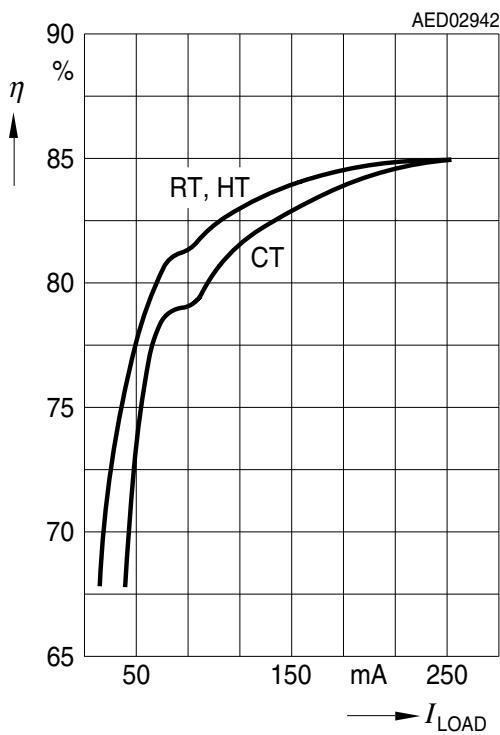

Buck ON Resistance vs. Junction Temperature

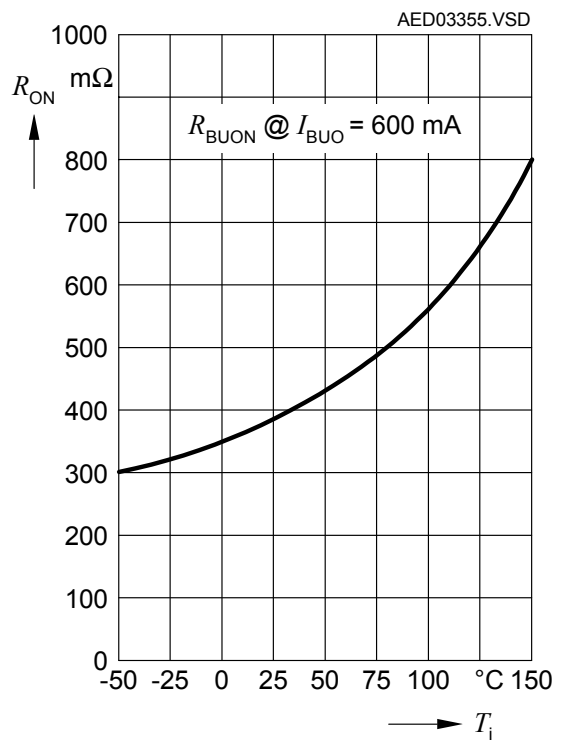

Package Outlines

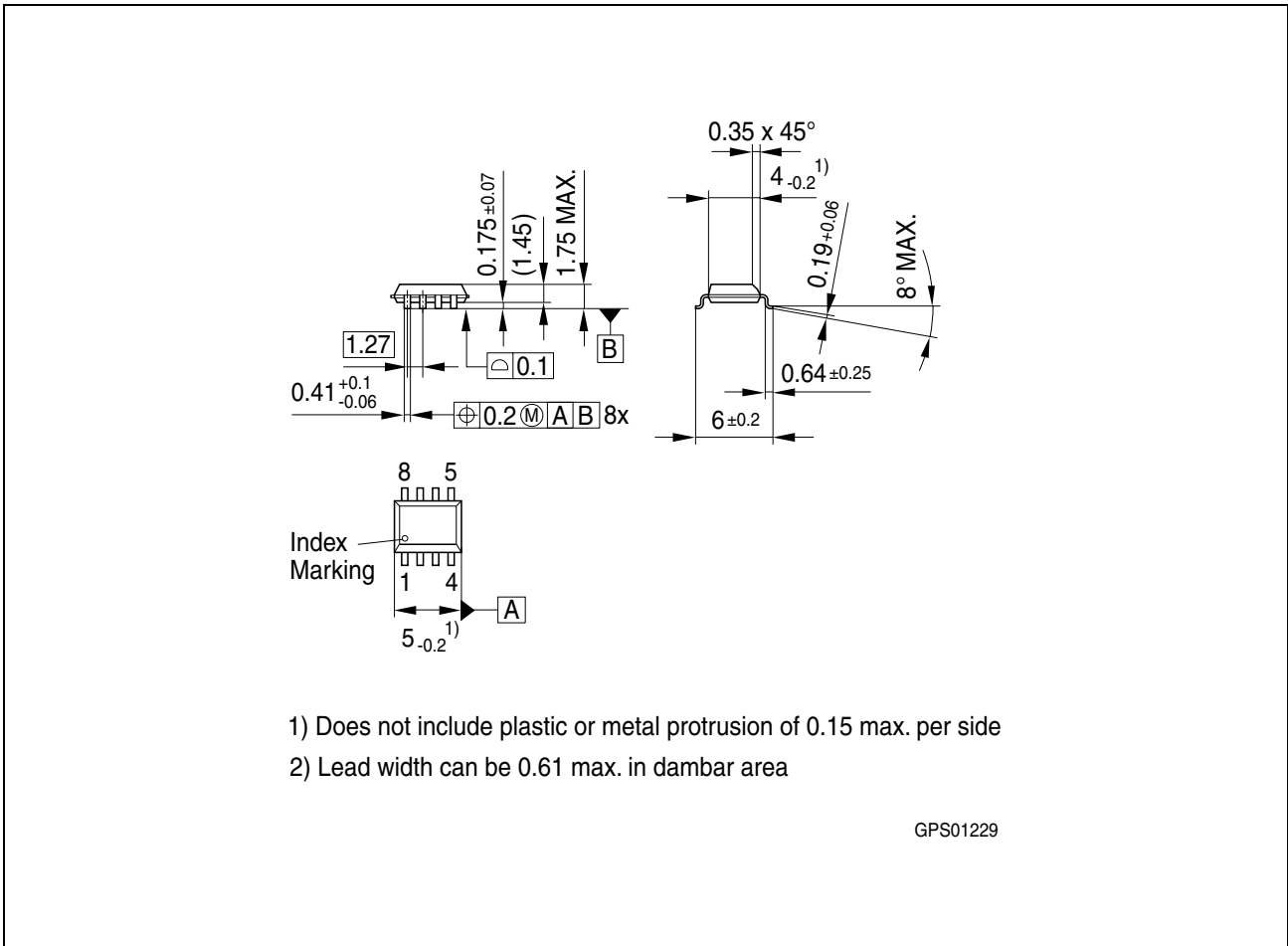

Figure 7 PG-DSO-8-16 (Plastic Dual Small Outline)

Green Product (RoHS compliant)

To meet the world-wide customer requirements for environmentally friendly products and to be compliant with government regulations the device is available as a green product. Green products are RoHS-Compliant (i.e Pb-free finish on leads and suitable for Pb-free soldering according to IPC/JEDEC J-STD-020).

You can find all of our packages, sorts of packing and others in our Infineon Internet Page “Products”: <http://www.infineon.com/products>.

SMD = Surface Mounted Device

Dimensions in mm

Revision History

Version	Date	Changes
Rev. 1.9	2007-07-30	Initial version of RoHS-compliant derivate of TLE 6365 Page 1 : AEC certified statement added Page 1 and Page 16 :RoHS compliance statement and Green product feature added Page 1 and Page 16 : Package changed to RoHS compliant version Legal Disclaimer and Infineon Logo updated

Edition 2007-07-30

**Published by
Infineon Technologies AG
81726 Munich, Germany**

**© 2007 Infineon Technologies AG
All Rights Reserved.**

Legal Disclaimer

The information given in this document shall in no event be regarded as a guarantee of conditions or characteristics. With respect to any examples or hints given herein, any typical values stated herein and/or any information regarding the application of the device, Infineon Technologies hereby disclaims any and all warranties and liabilities of any kind, including without limitation, warranties of non-infringement of intellectual property rights of any third party.

Information

For further information on technology, delivery terms and conditions and prices, please contact the nearest Infineon Technologies Office (www.infineon.com).

Warnings

Due to technical requirements, components may contain dangerous substances. For information on the types in question, please contact the nearest Infineon Technologies Office.

Infineon Technologies components may be used in life-support devices or systems only with the express written approval of Infineon Technologies, if a failure of such components can reasonably be expected to cause the failure of that life-support device or system or to affect the safety or effectiveness of that device or system. Life support devices or systems are intended to be implanted in the human body or to support and/or maintain and sustain and/or protect human life. If they fail, it is reasonable to assume that the health of the user or other persons may be endangered.

Компания «Океан Электроники» предлагает заключение долгосрочных отношений при поставках импортных электронных компонентов на взаимовыгодных условиях!

Наши преимущества:

- Поставка оригинальных импортных электронных компонентов напрямую с производств Америки, Европы и Азии, а так же с крупнейших складов мира;
- Широкая линейка поставок активных и пассивных импортных электронных компонентов (более 30 млн. наименований);
- Поставка сложных, дефицитных, либо снятых с производства позиций;
- Оперативные сроки поставки под заказ (от 5 рабочих дней);
- Экспресс доставка в любую точку России;
- Помощь Конструкторского Отдела и консультации квалифицированных инженеров;
- Техническая поддержка проекта, помощь в подборе аналогов, поставка прототипов;
- Поставка электронных компонентов под контролем ВП;
- Система менеджмента качества сертифицирована по Международному стандарту ISO 9001;
- При необходимости вся продукция военного и аэрокосмического назначения проходит испытания и сертификацию в лаборатории (по согласованию с заказчиком);
- Поставка специализированных компонентов военного и аэрокосмического уровня качества (Xilinx, Altera, Analog Devices, Intersil, Interpoint, Microsemi, Actel, Aeroflex, Peregrine, VPT, Syfer, Eurofarad, Texas Instruments, MS Kennedy, Miteq, Cobham, E2V, MA-COM, Hittite, Mini-Circuits, General Dynamics и др.);

Компания «Океан Электроники» является официальным дистрибьютором и эксклюзивным представителем в России одного из крупнейших производителей разъемов военного и аэрокосмического назначения «JONHON», а так же официальным дистрибьютором и эксклюзивным представителем в России производителя высокотехнологичных и надежных решений для передачи СВЧ сигналов «FORSTAR».



JONHON

«JONHON» (основан в 1970 г.)

Разъемы специального, военного и аэрокосмического назначения:

(Применяются в военной, авиационной, аэрокосмической, морской, железнодорожной, горно- и нефтедобывающей отраслях промышленности)

«FORSTAR» (основан в 1998 г.)

ВЧ соединители, коаксиальные кабели, кабельные сборки и микроволновые компоненты:

(Применяются в телекоммуникациях гражданского и специального назначения, в средствах связи, РЛС, а так же военной, авиационной и аэрокосмической отраслях промышленности).



Телефон: 8 (812) 309-75-97 (многоканальный)

Факс: 8 (812) 320-03-32

Электронная почта: ocean@oceanchips.ru

Web: <http://oceanchips.ru/>

Адрес: 198099, г. Санкт-Петербург, ул. Калинина, д. 2, корп. 4, лит. А