

THIS DRAWING IS UNPUBLISHED. RELEASED FOR PUBLICATION
 © COPYRIGHT - By - ALL RIGHTS RESERVED.

LOC	DIST	REVISIONS					
		P	LTR	DESCRIPTION	DATE	DWN	APVD
-	-	H2		REVISED PER ECO-11-004587	11MAR11	RK	HMR

LOC	DIST	DESCRIPTION	DATE	DWN	APVD	180.7	188.2	18	1-1546306-8	
-	-	-	-	-	-	171.2	178.7	17	1-1546306-7	
-	-	-	-	-	-	161.7	169.2	16	1-1546306-6	
△△△△	-	-	-	-	-	152.2	159.7	15	6-1546306-2	
-	-	-	-	-	-	152.2	159.7	15	1-1546306-5	
-	-	-	-	-	-	142.7	150.2	14	1-1546306-4	
-	-	-	-	-	-	133.2	140.7	13	1-1546306-3	
△△	-	-	-	-	-	123.7	131.2	12	4-1546306-0	
△△	-	-	-	-	-	123.7	131.2	12	3-1546306-3	
-	-	-	-	-	-	123.7	131.2	12	1-1546306-2	
△	-	-	11	-	-	114.2	121.7	11	5-1546306-2	
△△	-	-	-	2	-	114.2	121.7	11	3-1546306-4	
△	-	-	-	-	-	114.2	121.7	11	3-1546306-1	
-	-	-	-	-	-	114.2	121.7	11	1-1546306-1	
△	-	-	-	-	-	104.7	112.2	10	6-1546306-0	
△△	-	-	-	-	-	104.7	112.2	10	5-1546306-8	
-	-	-	-	-	-	104.7	112.2	10	1-1546306-0	
△△△	4	9	-	-	-	95.2	102.7	9	6-1546306-3	
△△	-	-	-	-	-	95.2	102.7	9	5-1546306-6	
-	-	-	-	-	-	95.2	102.7	9	1546306-9	
-	-	-	-	-	-	85.7	93.2	8	5-1546306-9	
△△	-	-	-	-	-	85.7	93.2	8	3-1546306-9	
-	-	-	-	-	-	85.7	93.2	8	1546306-8	
△△	-	-	-	-	-	76.2	83.7	7	5-1546306-5	
△	-	-	1	-	7	76.2	83.7	7	5-1546306-0	
-	-	-	-	-	-	76.2	83.7	7	4-1546306-5	
△	-	-	-	-	-	76.2	83.7	7	3-1546306-7	
-	-	-	-	-	-	76.2	83.7	7	1546306-7	
△△	-	-	-	-	-	66.7	74.2	6	5-1546306-4	
△△	-	-	-	-	1	6	66.7	74.2	6	4-1546306-9
-	-	-	-	6	-	-	66.7	74.2	6	4-1546306-8
-	-	-	-	-	-	-	66.7	74.2	6	4-1546306-4
△	-	-	-	-	-	6	66.7	74.2	6	3-1546306-6
-	-	-	-	-	-	-	66.7	74.2	6	1546306-6
△	-	-	-	-	-	5	57.2	64.7	5	5-1546306-7
△	5	5	-	-	-	-	57.2	64.7	5	5-1546306-3
△△	SCREW ON ONE SIDE	-	-	-	-	-	57.2	64.7	5	4-1546306-7
-	-	-	-	-	-	-	57.2	64.7	5	4-1546306-3
△	-	-	-	-	-	5	57.2	64.7	5	3-1546306-5
-	-	-	-	-	-	-	57.2	64.7	5	1546306-5
-	-	-	-	-	-	-	47.7	55.2	4	4-1546306-2
△△	-	-	-	-	-	-	47.7	55.2	4	3-1546306-8
-	-	-	-	-	-	-	47.7	55.2	4	1546306-4
-	3	3	-	-	-	-	38.2	45.7	3	6-1546306-1
-	-	-	-	-	-	-	38.2	45.7	3	5-1546306-1
-	-	-	-	-	-	-	38.2	45.7	3	1546306-3
△	-	-	-	-	2	2	28.7	36.2	2	4-1546306-6
-	-	-	-	2	2	2	28.7	36.2	2	4-1546306-1
-	-	-	-	-	-	-	28.7	36.2	2	1546306-2

NOTES	⑬ QC TAB .187 SS FLAT	⑫ QC TAB .187 SS FLAT	⑪ QC TAB .187 SS 90°	⑩ JUMPER	⑨ QC TAB DBL SIDE 90° .250	⑧ QC TAB DBL SIDE 45° .250	⑦ QC TAB DBL SIDE FLAT .250	⑥ QC TAB DBL SIDE 90° .187	⑤ QC TAB DBL SIDE 45° .187	④ QC TAB DBL SIDE FLAT .187	③ QC TAB SGL SIDE .250	② QC TAB SGL SIDE 45° .250	① QC TAB SGL SIDE FLAT .250	DIM B	DIM A	NO. OF POS.	PART NO.
-------	-----------------------	-----------------------	----------------------	----------	----------------------------	----------------------------	-----------------------------	----------------------------	----------------------------	-----------------------------	------------------------	----------------------------	-----------------------------	-------	-------	-------------	----------

THIS DRAWING IS A CONTROLLED DOCUMENT.

DWN S SCHLEGEL 20AUG2002
 CHK C RICHARD 8/20/02
 APVD C RICHARD 8/20/02
 PRODUCT SPEC
 APPLICATION SPEC
 WEIGHT -
 CUSTOMER DRAWING

DIMENSIONS: MM

TOLERANCES UNLESS OTHERWISE SPECIFIED:
 0 PLC ± -
 1 PLC ± 0.3
 2 PLC ± 0.25
 3 PLC ± -
 4 PLC ± -
 ANGLES ± 2°
 FINISH -

STE TE Connectivity
 9.50MM (.374) DBL ROW BARRIER STRIP W/O WASHER

SIZE A2 CAGE CODE 00779 DRAWING NO C=1546306 RESTRICTED TO -
 SCALE NTS SHEET 1 OF 3 REV H2

THIS DRAWING IS UNPUBLISHED. RELEASED FOR PUBLICATION
 © COPYRIGHT - By - ALL RIGHTS RESERVED.

LOC		DIST		REVISIONS			
P	LTR	DESCRIPTION	DATE	DWN	APVD		
-	-	SEE SHEET 1	-	-	-		

PHYSICAL PROPERTIES:
 HOUSING MATERIAL: THERMOPLASTIC, PC
 FLAMMABILITY: UL94V-0 COLOR: BLACK
 MAX BOW/WARP: .0056 IN/IN.

TERMINAL:
 TERMINALS: BRASS, TIN PLATED
 SCREWS: 6-32, STEEL, NICKEL PLATED

MECHANICAL:
 PITCH (TERMINAL SPACING): 9.50mm(.374")
 WIRE RANGE: 12-22 AWG
 RECOMMENDED TIGHTENING TORQUE: 12IN-LBS MAX.

ELECTRICAL PROPERTIES:
 MAXIMUM CURRENT: 20A
 OPERATING VOLTAGE: 300V

ENVIRONMENTAL PROPERTIES:
 OPERATING TEMP RANGE: -40°C TO +120°C.

- 1 SEE FIGURE.
- 2 MARKED WITH WHITE INK.
- 3 PRELIMINARY PART NUMBER.
- 4 SCREWS AND TERMINALS ARE NICKEL PLATED BRASS.
- 5 STAINLESS STEEL SCREWS.
- 6 SCREWS ARE NICKEL PLATED BRASS.
- 7 WIRE CLAMP SCREWS TO BE USED ONLY ON SIDE OPPOSITE QC TABS.
- 8 TE CONNECTIVITY LOGO LOCATED APPROXIMATE AREA SHOWN.

-- SELECT LOAD CHART --

-	-	4-5,5-6	-	-	-	-	ALL	-	-	-	-	11	3-1546306-4												
-	-	-	-	-	-	-	ALL	1-3	-	-	-	10	6-1546306-0												
-	-	1,2	-	-	-	ALL	-	-	-	-	-	7	5-1546306-0												
-	-	-	-	-	1	ALL	-	-	-	-	-	6	4-1546306-9												
12	QC TAB .187 SS FLAT	11	QC TAB .187 SS 90°	10	JUMPER	9	QC TAB DBL SIDE 90° .250	8	QC TAB DBL SIDE 45° .250	7	QC TAB DBL SIDE FLAT .250	6	QC TAB DBL SIDE 90° .187	5	QC TAB DBL SIDE 45° .187	4	QC TAB DBL SIDE FLAT .187	3	QC TAB SGL SIDE 90° .250	2	QC TAB SGL SIDE 45° .250	1	QC TAB SGL SIDE FLAT .250	NO. OF POS.	PART NUMBER
POSITIONS LOADED																									

-	-	-	-	-	-	-	-	-	-	-	-	-	-	-	-	-	-	-	-	-	-	-	-	-	294.7	302.2	30	3-1546306-0																																																																																																																																																																																																																																																																																																																																																																																																																																																																																																																																																																																																																																																																																																																																																																																																																																																																																																																																																																																																																																																																										
-	-	-	-	-	-	-	-	-	-	-	-	-	-	-	-	-	-	-	-	-	-	-	-	-	-	-	-	-	285.2	292.7	29	2-1546306-9																																																																																																																																																																																																																																																																																																																																																																																																																																																																																																																																																																																																																																																																																																																																																																																																																																																																																																																																																																																																																																																																						
-	-	-	-	-	-	-	-	-	-	-	-	-	-	-	-	-	-	-	-	-	-	-	-	-	-	-	-	-	-	-	275.7	283.2	28	2-1546306-8																																																																																																																																																																																																																																																																																																																																																																																																																																																																																																																																																																																																																																																																																																																																																																																																																																																																																																																																																																																																																																																																				
-	-	-	-	-	-	-	-	-	-	-	-	-	-	-	-	-	-	-	-	-	-	-	-	-	-	-	-	-	-	-	-	266.2	273.7	27	2-1546306-7																																																																																																																																																																																																																																																																																																																																																																																																																																																																																																																																																																																																																																																																																																																																																																																																																																																																																																																																																																																																																																																																			
-	-	-	-	-	-	-	-	-	-	-	-	-	-	-	-	-	-	-	-	-	-	-	-	-	-	-	-	-	-	-	-	256.7	264.2	26	2-1546306-6																																																																																																																																																																																																																																																																																																																																																																																																																																																																																																																																																																																																																																																																																																																																																																																																																																																																																																																																																																																																																																																																			
-	-	-	-	-	-	-	-	-	-	-	-	-	-	-	-	-	-	-	-	-	-	-	-	-	-	-	-	-	-	-	-	247.2	254.7	25	2-1546306-5																																																																																																																																																																																																																																																																																																																																																																																																																																																																																																																																																																																																																																																																																																																																																																																																																																																																																																																																																																																																																																																																			
-	-	-	-	-	-	-	-	-	-	-	-	-	-	-	-	-	-	-	-	-	-	-	-	-	-	-	-	-	-	-	-	237.7	245.2	24	2-1546306-4																																																																																																																																																																																																																																																																																																																																																																																																																																																																																																																																																																																																																																																																																																																																																																																																																																																																																																																																																																																																																																																																			
-	-	-	-	-	-	-	-	-	-	-	-	-	-	-	-	-	-	-	-	-	-	-	-	-	-	-	-	-	-	-	-	228.2	235.7	23	2-1546306-3																																																																																																																																																																																																																																																																																																																																																																																																																																																																																																																																																																																																																																																																																																																																																																																																																																																																																																																																																																																																																																																																			
-	-	-	-	-	-	-	-	-	-	-	-	-	-	-	-	-	-	-	-	-	-	-	-	-	-	-	-	-	-	-	-	218.7	226.2	22	2-1546306-2																																																																																																																																																																																																																																																																																																																																																																																																																																																																																																																																																																																																																																																																																																																																																																																																																																																																																																																																																																																																																																																																			
-	-	-	-	-	-	-	-	-	-	-	-	-	-	-	-	-	-	-	-	-	-	-	-	-	-	-	-	-	-	-	-	209.2	216.7	21	2-1546306-1																																																																																																																																																																																																																																																																																																																																																																																																																																																																																																																																																																																																																																																																																																																																																																																																																																																																																																																																																																																																																																																																			
1	2	3	4	5	6	7	8	9	10	11	12	13	14	15	16	17	18	19	20	21	22	23	24	25	26	27	28	29	30	31	32	33	34	35	36	37	38	39	40	41	42	43	44	45	46	47	48	49	50	51	52	53	54	55	56	57	58	59	60	61	62	63	64	65	66	67	68	69	70	71	72	73	74	75	76	77	78	79	80	81	82	83	84	85	86	87	88	89	90	91	92	93	94	95	96	97	98	99	100	101	102	103	104	105	106	107	108	109	110	111	112	113	114	115	116	117	118	119	120	121	122	123	124	125	126	127	128	129	130	131	132	133	134	135	136	137	138	139	140	141	142	143	144	145	146	147	148	149	150	151	152	153	154	155	156	157	158	159	160	161	162	163	164	165	166	167	168	169	170	171	172	173	174	175	176	177	178	179	180	181	182	183	184	185	186	187	188	189	190	191	192	193	194	195	196	197	198	199	200	201	202	203	204	205	206	207	208	209	210	211	212	213	214	215	216	217	218	219	220	221	222	223	224	225	226	227	228	229	230	231	232	233	234	235	236	237	238	239	240	241	242	243	244	245	246	247	248	249	250	251	252	253	254	255	256	257	258	259	260	261	262	263	264	265	266	267	268	269	270	271	272	273	274	275	276	277	278	279	280	281	282	283	284	285	286	287	288	289	290	291	292	293	294	295	296	297	298	299	300	301	302	303	304	305	306	307	308	309	310	311	312	313	314	315	316	317	318	319	320	321	322	323	324	325	326	327	328	329	330	331	332	333	334	335	336	337	338	339	340	341	342	343	344	345	346	347	348	349	350	351	352	353	354	355	356	357	358	359	360	361	362	363	364	365	366	367	368	369	370	371	372	373	374	375	376	377	378	379	380	381	382	383	384	385	386	387	388	389	390	391	392	393	394	395	396	397	398	399	400	401	402	403	404	405	406	407	408	409	410	411	412	413	414	415	416	417	418	419	420	421	422	423	424	425	426	427	428	429	430	431	432	433	434	435	436	437	438	439	440	441	442	443	444	445	446	447	448	449	450	451	452	453	454	455	456	457	458	459	460	461	462	463	464	465	466	467	468	469	470	471	472	473	474	475	476	477	478	479	480	481	482	483	484	485	486	487	488	489	490	491	492	493	494	495	496	497	498	499	500	501	502	503	504	505	506	507	508	509	510	511	512	513	514	515	516	517	518	519	520	521	522	523	524	525	526	527	528	529	530	531	532	533	534	535	536	537	538	539	540	541	542	543	544	545	546	547	548	549	550	551	552	553	554	555	556	557	558	559	560	561	562	563	564	565	566	567	568	569	570	571	572	573	574	575	576	577	578	579	580	581	582	583	584	585	586	587	588	589	590	591	592	593	594	595	596	597	598	599	600	601	602	603	604	605	606	607	608	609	610	611	612	613	614	615	616	617	618	619	620	621	622	623	624	625	626	627	628	629	630	631	632	633	634	635	636	637	638	639	640	641	642	643	644	645	646	647	648	649	650	651	652	653	654	655	656	657	658	659	660	661	662	663	664	665	666	667	668	669	670	671	672	673	674	675	676	677	678	679	680	681	682	683	684	685	686	687	688	689	690	691	692	693	694	695	696	697	698	699	700	701	702	703	704	705	706	707	708	709	710	711	712	713	714	715	716	717	718	719	720	721	722	723	724	725	726	727	728	729	730	731	732	733	734	735	736	737	738	739	740	741	742	743	744	745	746	747	748	749	750	751	752	753	754	755	756	757	758	759	760	761	762	763	764	765	766	767	768	769	770	771	772	773	774	775	776	777	778	779	780	781	782	783	784	785	786	787	788	789	790	791	792	793	794	795	796	797	798	799	800	801	802	803	804	805	806	807	808	809	810	811	812	813	814	815	816	817	818	819	820	821	822	823	824	825	826	827	828	829	830	831	832	833	834	835	836	837	838	839	840	841	842	843	844	845	846	847	848	849	850	851	852	853	854	855	856	857	858	859	860	861	862	863	864	865	866	867	868	869	870	871	872	873	874	875	876	877	878	879	880	881	882	883	884	885	886	887	888	889	890	891	892	893	894	895	896	897	898	899	900	901	902	903	904	905	906	907	908	909	910	911	912	913	914	915	916	917	918	919	920	921	922	923	924	925	926	927	928	929	930	931	932	933	934	935	936	937	938	939	940	941	942	943	944	945	946	947	948	949	950	951	952	953	954	955	956	957	958	959	960	961	962	963	964	965	966	967	968	969	970	971	972	973	974	975	976	977	978	979	980	981	982	983	984	985	986	987	988	989	990	991	992	993	994	995	996	997	998	999	1000	1001	1002	1003	1004	1005	1006	1007	1008	1009	1010	1011	1012	1013	1014	1015	1016	1017	1018	1019	1020	1021	1022	1023	1024	1025	1026	1027	1028	1029	1030	1031	1032	1033	1034	1035	1036	1037	1038	1039	1040	1041	1042	1043	1044	1045	1046	1047	1048	1049	1050	1051	1052	1053	1054	1055	1056	1057	1058	1059	1060	1061	1062	1063

THIS DRAWING IS UNPUBLISHED. RELEASED FOR PUBLICATION
 © COPYRIGHT - By - ALL RIGHTS RESERVED.

LOC		DIST		REVISIONS			
P	LTR	DESCRIPTION	DATE	DWN	APVD		
-	-	SEE SHEET 1	-	-	-	-	-

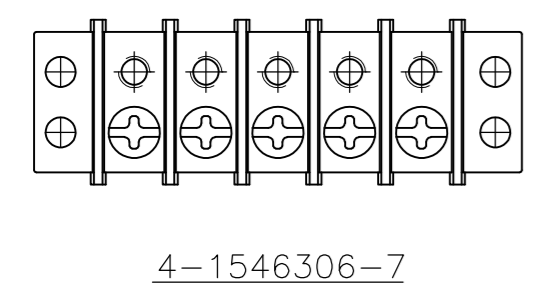
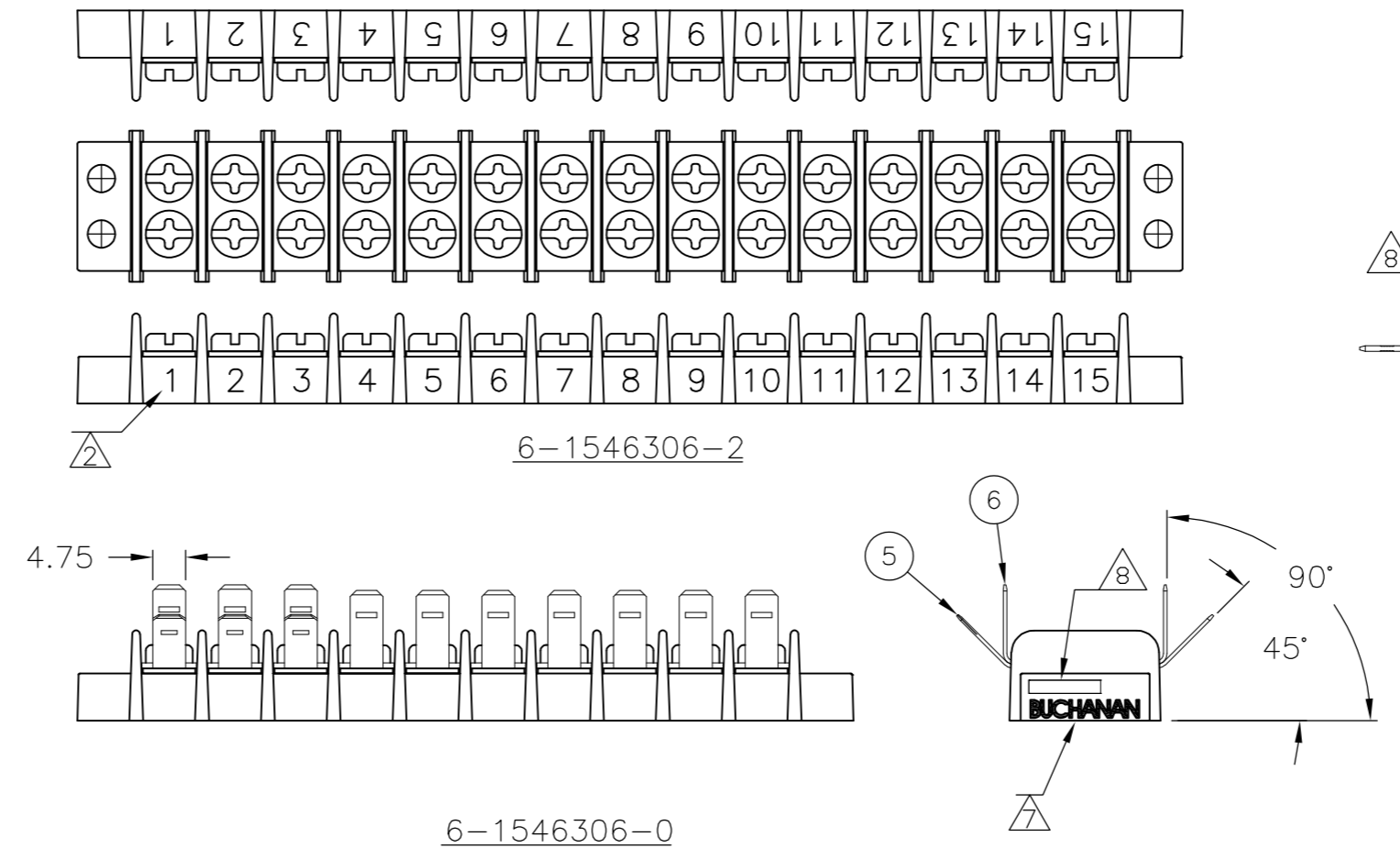
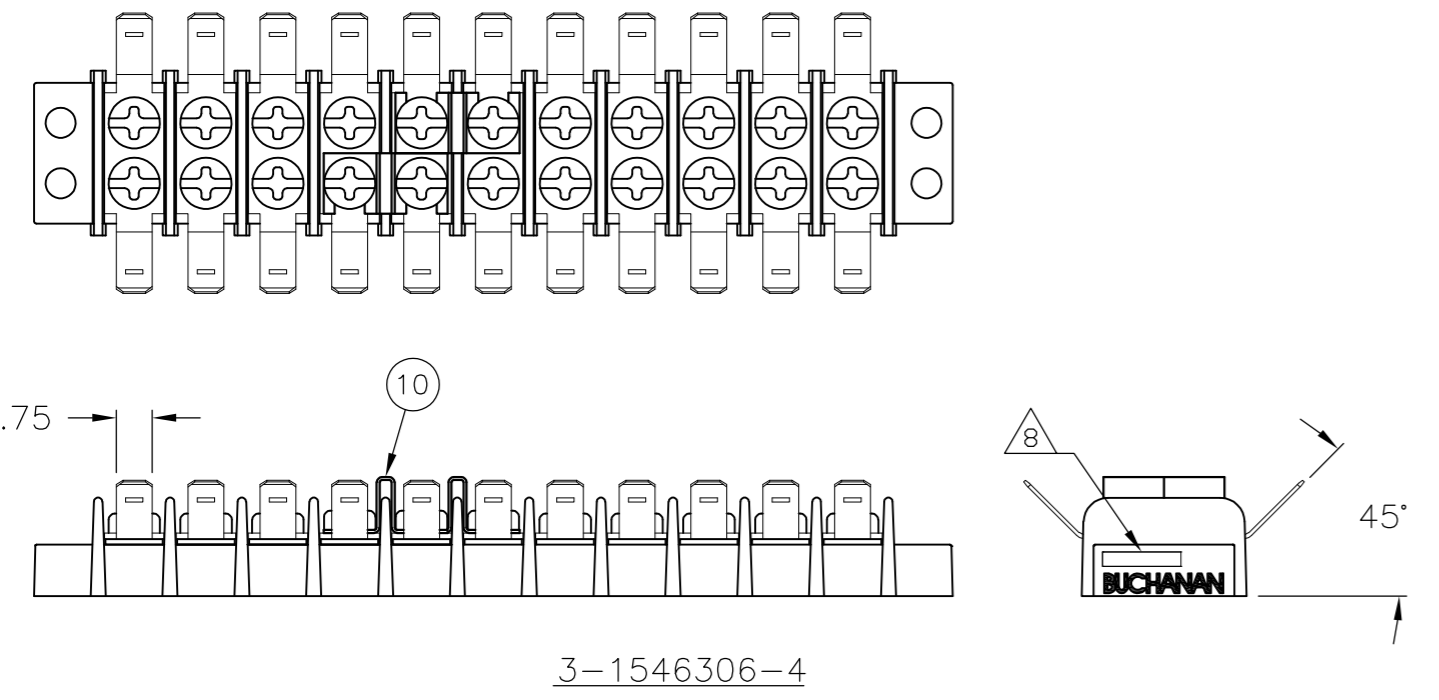
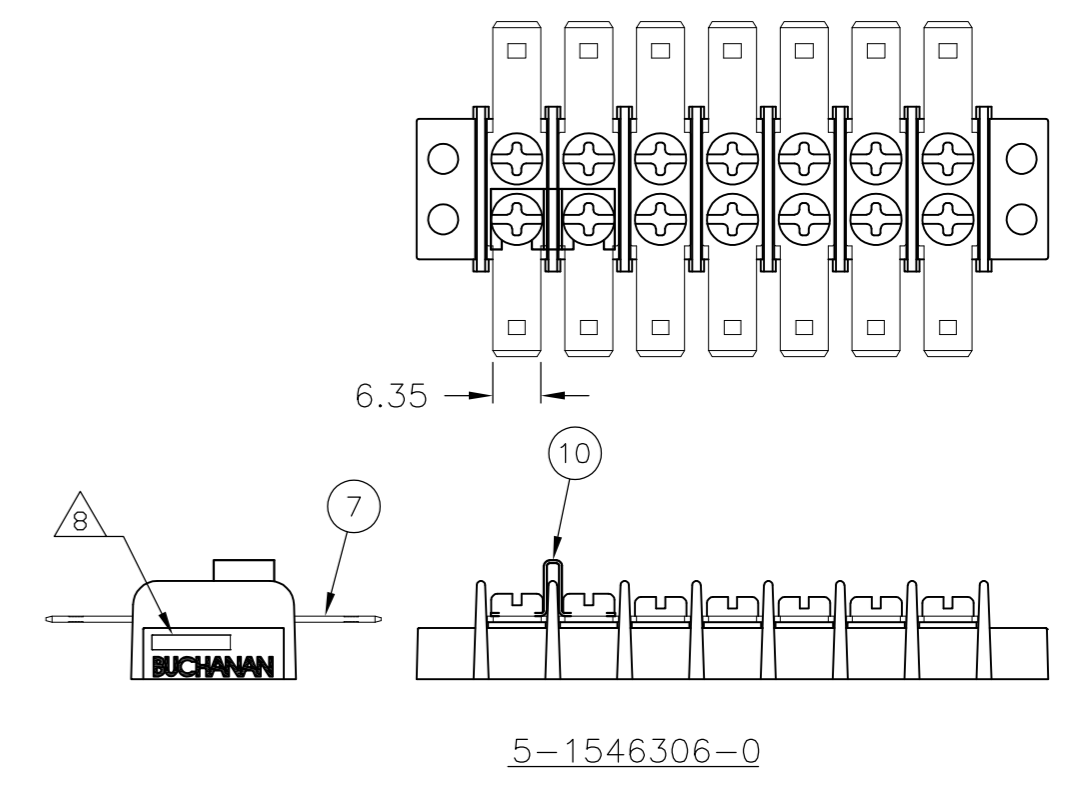
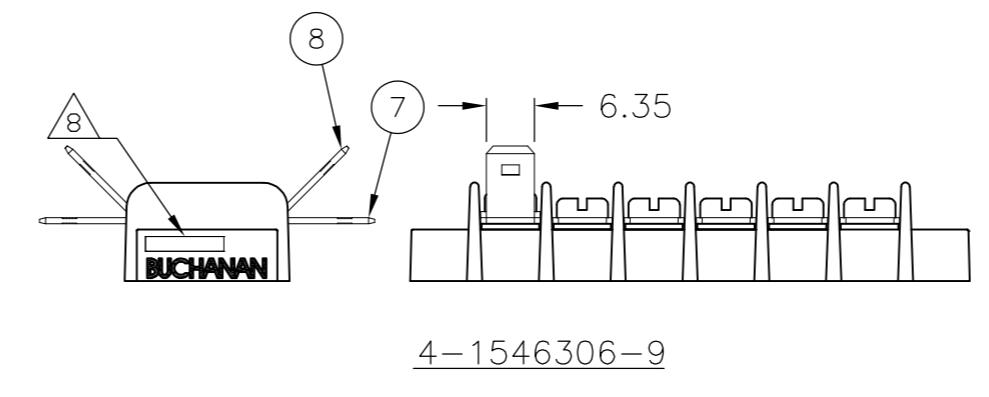
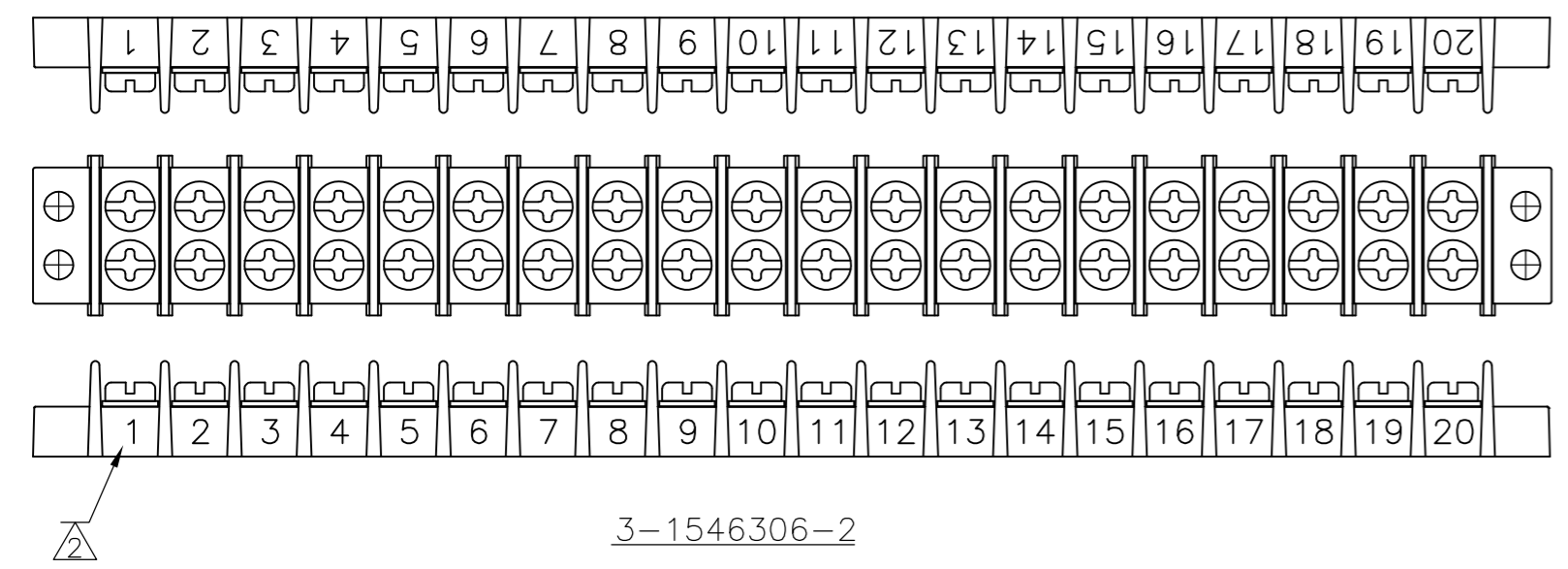
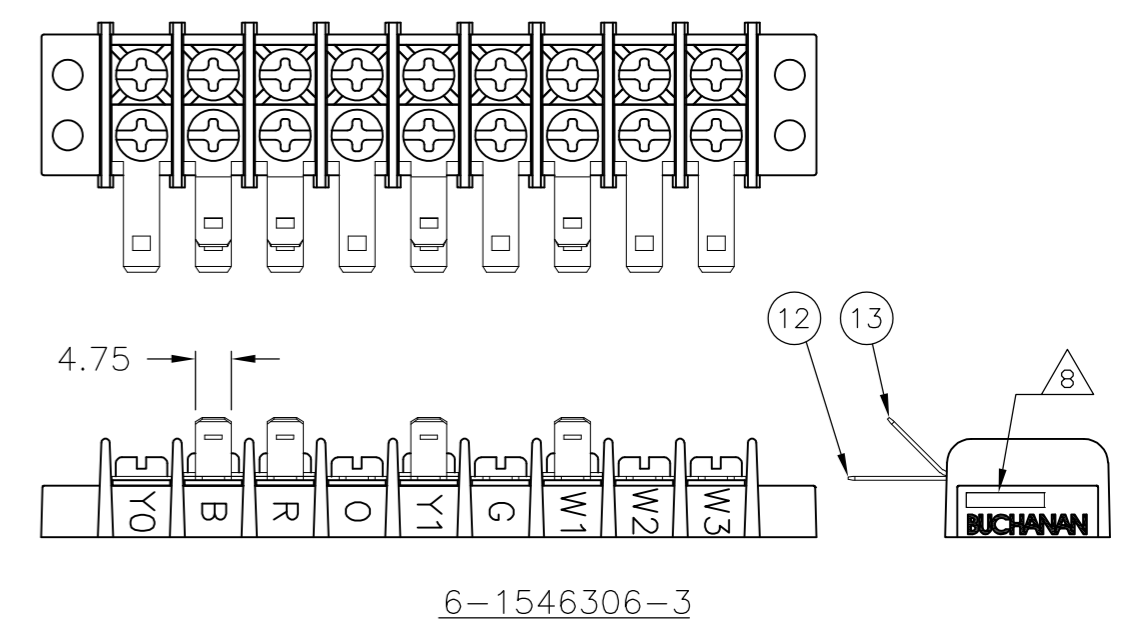

THIS DRAWING IS A CONTROLLED DOCUMENT.		DWN	20AUG2002		 TE Connectivity			
		CHK	S SCHLEGEL 8/20/02					
		APVD	C RICHARD 8/20/02		NAME 9.50MM (.374) DBL ROW BARRIER STRIP W/O WASHER			
		PRODUCT SPEC	C RICHARD					
DIMENSIONS: MM		TOLERANCES UNLESS OTHERWISE SPECIFIED:		APPLICATION SPEC	SIZE	CAGE CODE	DRAWING NO	RESTRICTED TO
0 PLC ± - 1 PLC ± 0.3 2 PLC ± 0.25 3 PLC ± - 4 PLC ± - ANGLES ± 2°		FINISH		WEIGHT	A2	00779	C=1546306	-
MATERIAL		FINISH		CUSTOMER DRAWING	SCALE	NTS	SHEET	3 OF 3
								REV H2

Компания «Океан Электроники» предлагает заключение долгосрочных отношений при поставках импортных электронных компонентов на взаимовыгодных условиях!

Наши преимущества:

- Поставка оригинальных импортных электронных компонентов напрямую с производств Америки, Европы и Азии, а так же с крупнейших складов мира;
- Широкая линейка поставок активных и пассивных импортных электронных компонентов (более 30 млн. наименований);
- Поставка сложных, дефицитных, либо снятых с производства позиций;
- Оперативные сроки поставки под заказ (от 5 рабочих дней);
- Экспресс доставка в любую точку России;
- Помощь Конструкторского Отдела и консультации квалифицированных инженеров;
- Техническая поддержка проекта, помощь в подборе аналогов, поставка прототипов;
- Поставка электронных компонентов под контролем ВП;
- Система менеджмента качества сертифицирована по Международному стандарту ISO 9001;
- При необходимости вся продукция военного и аэрокосмического назначения проходит испытания и сертификацию в лаборатории (по согласованию с заказчиком);
- Поставка специализированных компонентов военного и аэрокосмического уровня качества (Xilinx, Altera, Analog Devices, Intersil, Interpoint, Microsemi, Actel, Aeroflex, Peregrine, VPT, Syfer, Eurofarad, Texas Instruments, MS Kennedy, Miteq, Cobham, E2V, MA-COM, Hittite, Mini-Circuits, General Dynamics и др.);

Компания «Океан Электроники» является официальным дистрибьютором и эксклюзивным представителем в России одного из крупнейших производителей разъемов военного и аэрокосмического назначения «JONHON», а так же официальным дистрибьютором и эксклюзивным представителем в России производителя высокотехнологичных и надежных решений для передачи СВЧ сигналов «FORSTAR».



JONHON

«JONHON» (основан в 1970 г.)

Разъемы специального, военного и аэрокосмического назначения:

(Применяются в военной, авиационной, аэрокосмической, морской, железнодорожной, горно- и нефтедобывающей отраслях промышленности)

«FORSTAR» (основан в 1998 г.)

ВЧ соединители, коаксиальные кабели, кабельные сборки и микроволновые компоненты:

(Применяются в телекоммуникациях гражданского и специального назначения, в средствах связи, РЛС, а так же военной, авиационной и аэрокосмической отраслях промышленности).



Телефон: 8 (812) 309-75-97 (многоканальный)

Факс: 8 (812) 320-03-32

Электронная почта: ocean@oceanchips.ru

Web: <http://oceanchips.ru/>

Адрес: 198099, г. Санкт-Петербург, ул. Калинина, д. 2, корп. 4, лит. А