LOW VOLTAGE DETECTOR WITH BUILT-IN DELAY CIRCUIT

NO.EA-093-160314

OUTLINE

R3132x/R3133x Series are CMOS-based low voltage detector ICs with built-in delay circuit, high detector threshold accuracy, and ultra low supply current, which can operate at low voltage.

These ICs can be used as system reset generators, and each of these ICs consists of a voltage reference, a comparator, resistors for setting voltage detector threshold, an output driver transistor, manual reset circuit, and an output delay generator.

Detector threshold is fixed internally with high accuracy and requires no adjustment. When a supply voltage crosses a setting detector threshold voltage from a high value to a lower value, this IC generates reset signal.

R3132x Series output "L" at its detect, while R3133x Series output "H".

Since each of R3132x/R3133x Series embeds an output delay generator, during a setting 240ms delay time, which is fixed in the IC, this IC keeps the reset condition after they are released. Released conditions are the case when a supply voltage crosses a setting detector threshold voltage from a low value to a higher value, or when this IC is released from manual reset.

Two output types, Nch open drain type and CMOS type, are available.

Since the package for these ICs are ultra small SC-82AB package and SON1612-6, high density mounting of the ICs on board is possible.

FEATURES

- Supply current..... Typ. 0.8 μ A (R313xx27x: $V_{DD}=3.0V$)
- Operating Voltage Range..... 0.8V to 6.0V ($T_{opt}=25^{\circ}C$)
- Detector Threshold..... Setting with a step of 0.1V in the range of 1.0V to 5.0V is possible. Further, 2.32V, 2.63V, 2.93V, 3.08V, 4.38V, and 4.63V can be provided as standard.
- Embedded Power on Reset Delay Time Circuit..... Typ. 240ms
- Detector Threshold Accuracy..... $\pm 2.0\%$
- Released Delay Time Accuracy $\pm 15.0\%$
- Temperature-Drift Coefficient of Detector Threshold Typ. $\pm 100ppm/^{\circ}C$
- Output Types Nch Open Drain and CMOS
- Packages SC-82AB, SON1612-6

APPLICATIONS

- CPU and Logic Circuit Reset
- Battery Checker
- Window Comparator
- Wave Shaping Circuit
- Battery Back-up Circuit
- Power Failure Detector

R3132x/R3133x

BLOCK DIAGRAMS

R3132xxxEA Nch Open Drain Output



R3132xxxEC CMOS Output

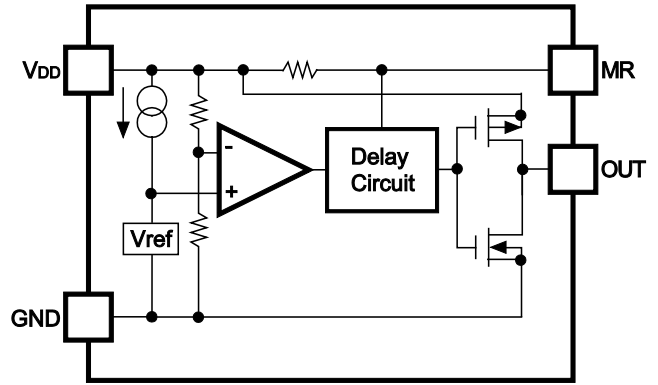

R3133xxxEA Nch Open Drain Output



R3133xxxEC CMOS Output

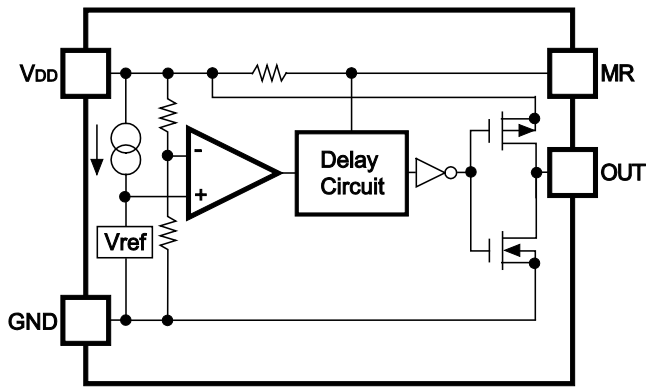

* R3133Q (SC-82AB) is the discontinued product as of March, 2016.

R3132x/R3133x

SELECTION GUIDE

The package type, the detector threshold, the output type and the taping type for the ICs can be selected at the users' request.

Product Name	Package	Quantity per Reel	Pb Free	Halogen Free
R3132DxxE*(y)-TR-FE R3133DxxE*(y)-TR-FE	SON1612-6	4,000 pcs	Yes	Yes
R3132QxxE*(y)-TR-FE R3133QxxE*(y)-TR-FE	SC-82AB	3,000 pcs	Yes	Yes

xx: The detector threshold can be designated in the range from 1.0V(10) to 5.0V(50) in 0.1V steps.
y: If the detector threshold includes the 3rd digit, indicate the digit of 0.01V.
(2.32V, 2.63V, 2.93V, 3.08V, 4.38V, 4.63V)
Ex. If the detector threshold is 2.63V, R3132x26E*3-TR-FE.

* : Designation of Output Type
(A) Nch Open Drain
(C) CMOS

R3132x/R3133x

PIN CONFIGURATIONS

• SON1612-6



• SC-82AB



PIN DESCRIPTIONS

• SON1612-6

Pin No	Symbol	Pin Description
1	V _{DD}	Input Pin
2	GND	Ground Pin
3	MR	Manual Reset Input Pin Active at "L" input. Pulled up via 1MΩ. If MR pin is not necessary, open this node, or connect to V _{DD} .
4	OUT	Output Pin R3132D Series:"L" at detection R3133D Series:"H" at detection
5	GND	Ground Pin
6	NC	No Connection

• SC-82AB

Pin No	Symbol	Pin Description
1	GND	Ground Pin
2	OUT	Output Pin R3132Q Series : "L" at detection R3133Q Series : "H" at detection
3	MR	Manual Reset Input Pin Active at "L" input. Pulled up via 1MΩ. If MR pin is not necessary, open this node, or connect to V _{DD} .
4	V _{DD}	Input Pin

ABSOLUTE MAXIMUM RATINGS

Symbol	Item	Rating	Unit
V_{DD}	Supply Voltage	6.5	V
V_{OUT}	Output Voltage (Nch Open Drain Output)	$V_{SS}-0.3$ to 6.5	V
	Output Voltage (CMOS Output)	$V_{SS}-0.3$ to $V_{DD}+0.3$	
V_{MR}	Input Voltage	$V_{SS}-0.3$ to $V_{DD}+0.3$	V
I_{OUT}	Output Current	20	mA
P_D	Power Dissipation (SON1612-6)*1, *2	500	mW
	Power Dissipation (SC-82AB)*2	380	
T_{opt}	Operating Temperature Range	-40 to 85	°C
T_{stg}	Storage Temperature Range	-55 to 125	°C
T_{solder}	Soldering Temperature	260°C, 10s	

*1) This specification is at mounted on board.

P_D depends on conditions of mounting on board. This specification is based on the measurement at the condition below:

*Measurement Conditions

Environment: Mounted on board (Wind velocity 0m/s)

Board Material: FR-4 (2-layer)

Board dimensions : 40mm x 40mm x t1.6mm

Copper Area : 50%

*2) For Power Dissipation, please refer to PACKAGE INFORMATION.

ABSOLUTE MAXIMUM RATINGS

Electronic and mechanical stress momentarily exceeded absolute maximum ratings may cause the permanent damages and may degrade the life time and safety for both device and system using the device in the field. The functional operation at or over these absolute maximum ratings is not assured.

* R3133Q (SC-82AB) is the discontinued product as of March, 2016.

R3132x/R3133x

ELECTRICAL CHARACTERISTICS

T_{opt}=25°C

Symbol	Item	Test Conditions	Min.	Typ.	Max.	Unit	
V _{DD}	Operating Voltage	R3132	T _{opt} =25°C	0.75		6.0	V
			-40°C≤T _{opt} ≤85°C	0.85		6.0	
		R3133	T _{opt} =25°C	0.80		6.0	
			-40°C≤T _{opt} ≤85°C	0.90		6.0	
V _{DET}	Detector Threshold		V _{DET} × 0.98		V _{DET} × 1.02	V	
I _{SS1}	Supply Current1	V _{DD} =V _{DET} -0.1V, I _{OUT} =0A			2.0	μA	
I _{SS2}	Supply Current2	V _{DD} =V _{DET} +0.1V, I _{OUT} =0A			2.0	μA	
I _{SS3}	Supply Current3	V _{DD} =6.0V, I _{OUT} =0A	V _{DET} <1.6V			3.6	μA
			1.6V≤V _{DET} <2.7V			3.0	
			2.7V≤V _{DET}			2.5	
V _{OH}	"H" Output Voltage	Refer to the following table.					
V _{OL}	"L" Output Voltage	Refer to the following table.					
R _{MR}	MR pin pull-up resistance	T _{opt} =25°C	0.5	1.0	4.0	MΩ	
T _{rst} *	Output Delay Time for detect	V _{DD} =V _{DET} to V _{DET} -0.1V		15		μs	
T _{delay}	Output Delay Time for release	V _{DD} =0.8V to V _{DET} +1.0V	204	240	276	ms	
ΔV _{DET} / ΔT _{opt}	Detector Threshold Temperature Coefficient	-40°C≤T _{opt} ≤85°C		±100		ppm/ °C	

*) Guaranteed by design, not mass production tested.

RECOMMENDED OPERATING CONDITIONS (ELECTRICAL CHARACTERISTICS)

All of electronic equipment should be designed that the mounted semiconductor devices operate within the recommended operating conditions. The semiconductor devices cannot operate normally over the recommended operating conditions, even if when they are used over such conditions by momentary electronic noise or surge. And the semiconductor devices may receive serious damage when they continue to operate over the recommended operating conditions.

• "H" Output Voltage (V_{OH}) table

$T_{opt}=25^{\circ}\text{C}$

Products	Test Conditions		Min.	Typ.	Max.	Unit
R3132xxxEC	$V_{DET}<1.2\text{V}$	$V_{DD}=V_{DET}+0.1\text{V}$, $I_{OH}=-50\mu\text{A}$	$0.8\times V_{DD}$			V
	$1.2\text{V}\leq V_{DET}<2.0\text{V}$	$V_{DD}=V_{DET}+0.1\text{V}$, $I_{OH}=-150\mu\text{A}$				
	$2.0\text{V}\leq V_{DET}<3.1\text{V}$	$V_{DD}=V_{DET}+0.1\text{V}$, $I_{OH}=-500\mu\text{A}$				
	$3.1\text{V}\leq V_{DET}$	$V_{DD}=V_{DET}+0.1\text{V}$, $I_{OH}=-800\mu\text{A}$				
R3133xxxEC	$V_{DET}<1.2\text{V}$	$V_{DD}=V_{DET}-0.1\text{V}$, $I_{OH}=-10\mu\text{A}$	$0.8\times V_{DD}$			V
	$1.2\text{V}\leq V_{DET}<2.0\text{V}$	$V_{DD}=V_{DET}-0.1\text{V}$, $I_{OH}=-100\mu\text{A}$				
	$2.0\text{V}\leq V_{DET}<3.1\text{V}$	$V_{DD}=V_{DET}-0.1\text{V}$, $I_{OH}=-500\mu\text{A}$				
	$3.1\text{V}\leq V_{DET}$	$V_{DD}=V_{DET}-0.1\text{V}$, $I_{OH}=-800\mu\text{A}$				

V_{DET} is a set value.

• "L" Output Voltage (V_{OL}) table

$T_{opt}=25^{\circ}\text{C}$

Symbol	Item	Test Conditions	Min.	Typ.	Max.	Unit		
R3132xxxEx	$V_{DET}<1.2\text{V}$	$V_{DD}=V_{DET}-0.1\text{V}$, $I_{OL}=20\mu\text{A}$			0.3	V		
	$1.2\text{V}\leq V_{DET}<1.6\text{V}$	$V_{DD}=V_{DET}-0.1\text{V}$, $I_{OL}=750\mu\text{A}$						
	$1.6\text{V}\leq V_{DET}<3.1\text{V}$	$V_{DD}=V_{DET}-0.1\text{V}$, $I_{OL}=1.2\text{mA}$					0.4	V
	$3.1\text{V}\leq V_{DET}$	$V_{DD}=V_{DET}-0.1\text{V}$, $I_{OL}=3.2\text{mA}$						
R3133xxxEx	$V_{DET}<1.2\text{V}$	$V_{DD}=V_{DET}+0.1\text{V}$, $I_{OL}=20\mu\text{A}$			0.3	V		
	$1.2\text{V}\leq V_{DET}<1.6\text{V}$	$V_{DD}=V_{DET}+0.1\text{V}$, $I_{OL}=750\mu\text{A}$						
	$1.6\text{V}\leq V_{DET}<3.1\text{V}$	$V_{DD}=V_{DET}+0.1\text{V}$, $I_{OL}=1.2\text{mA}$					0.4	V
	$3.1\text{V}\leq V_{DET}$	$V_{DD}=V_{DET}+0.1\text{V}$, $I_{OL}=3.2\text{mA}$						

V_{DET} is a set value.

* R3133Q (SC-82AB) is the discontinued product as of March, 2016.

R3132x/R3133x

DETECTOR THRESHOLD SPECIFICATIONS BY PART NUMBER

• R3132x

Part Number	Operating Voltage				Detector Threshold			Supply Current 1		
	V _{DD} [V]				V _{DET} [V]			I _{SS1} [μA]		
	Conditions	Min.	Conditions	Min.	Min.	Typ.	Max.	Conditions	Typ.	Max.
R3132x23Ex2	T _{opt} =25°C	0.75	-40°C ≤ T _{opt} ≤ 85°C	0.85	2.274	2.320	2.366	V _{DD} =V _{DET} -0.1V I _{OUT} =0A	0.8	2.0
R3132x26Ex3					2.578	2.630	2.682			
R3132x29Ex3					2.872	2.930	2.988			
R3132x30Ex8					3.019	3.080	3.141			
R3132x43Ex8					4.293	4.380	4.467			
R3132x46Ex3					4.538	4.630	4.722			
R3132x10Ex	T _{opt} =25°C	0.75	-40°C ≤ T _{opt} ≤ 85°C	0.85	0.980	1.000	1.020	V _{DD} =V _{DET} -0.1V I _{OUT} =0A	0.8	2.0
R3132x11Ex					1.078	1.100	1.122			
R3132x12Ex					1.176	1.200	1.224			
R3132x13Ex					1.274	1.300	1.326			
R3132x14Ex					1.372	1.400	1.428			
R3132x15Ex					1.470	1.500	1.530			
R3132x16Ex					1.568	1.600	1.632			
R3132x17Ex					1.666	1.700	1.734			
R3132x18Ex					1.764	1.800	1.836			
R3132x19Ex					1.862	1.900	1.938			
R3132x20Ex					1.960	2.000	2.040			
R3132x21Ex					2.058	2.100	2.142			
R3132x22Ex					2.156	2.200	2.244			
R3132x23Ex					2.254	2.300	2.346			
R3132x24Ex					2.352	2.400	2.448			
R3132x25Ex					2.450	2.500	2.550			
R3132x26Ex					2.548	2.600	2.652			
R3132x27Ex					2.646	2.700	2.754			
R3132x28Ex					2.744	2.800	2.856			
R3132x29Ex					2.842	2.900	2.958			
R3132x30Ex					2.940	3.000	3.060		0.9	
R3132x31Ex					3.038	3.100	3.162			
R3132x32Ex					3.136	3.200	3.264			
R3132x33Ex					3.234	3.300	3.366			
R3132x34Ex					3.332	3.400	3.468			
R3132x35Ex					3.430	3.500	3.570			
R3132x36Ex					3.528	3.600	3.672			
R3132x37Ex					3.626	3.700	3.774			
R3132x38Ex					3.724	3.800	3.876			
R3132x39Ex					3.822	3.900	3.978			
R3132x40Ex	3.920	4.000	4.080							
R3132x41Ex	4.018	4.100	4.182							
R3132x42Ex	4.116	4.200	4.284							
R3132x43Ex	4.214	4.300	4.386							
R3132x44Ex	4.312	4.400	4.488							
R3132x45Ex	4.410	4.500	4.590							
R3132x46Ex	4.508	4.600	4.692							
R3132x47Ex	4.606	4.700	4.794							
R3132x48Ex	4.704	4.800	4.896							
R3132x49Ex	4.802	4.900	4.998							
R3132x50Ex	4.900	5.000	5.100							

* R3133Q (SC-82AB) is the discontinued product as of March, 2016.

R3132x/R3133x

Supply Current 2			Supply Current 3			"H" Output Voltage	
Iss2[μA]			Iss3[μA]			Voh[V]	
Conditions	Typ.	Max.	Conditions	Typ.	Max.	Conditions	Min.
VDD=VDET+0.1V IOUT=0A	0.8	2.0	VDD=6.0V IOUT=0A	1.2	3.0	VDD=VDET+0.1V IOH=-500μA	0.8× VDD
				1.0	2.5	VDD=VDET+0.1V IOH=-800μA	
VDD=VDET+0.1V IOUT=0A	0.8	2.0	VDD=6.0V IOUT=0A	1.4	3.6	VDD=VDET+0.1V IOH=-50μA	0.8× VDD
						VDD=VDET+0.1V IOH=-150μA	
				1.2	3.0	VDD=VDET+0.1V IOH=-500μA	
						VDD=VDET+0.1V IOH=-800μA	
				1.0	2.5	VDD=VDET+0.1V IOH=-800μA	
						0.8	

* R3133Q (SC-82AB) is the discontinued product as of March, 2016.

R3132x/R3133x

Part Number	"L" Output Voltage		MR pin "H" Input Voltage		MR pin "L" Input Voltage		MR pin pull-up resistance			
	VOL[V]		VIH[V]		VIL[V]		RMR[MΩ]			
	Conditions	Max.	Conditions	Min.	Conditions	Max.	Conditions	Min.	Typ.	Max.
R3132x23Ex2	VDD=VDET-0.1V IOL=+1.2mA	0.3	VDD≥VDET+0.1	0.75× VDD	VDD≥VDET+0.1	0.2× VDD	Topt=25°C	0.5	1.0	4.0
R3132x26Ex3										
R3132x29Ex3										
R3132x30Ex8										
R3132x43Ex8	VDD=VDET-0.1V IOL=+3.2mA	0.4	VDD≥VDET+0.1	0.75× VDD	VDD≥VDET+0.1	0.2× VDD	Topt=25°C	0.5	1.0	4.0
R3132x46Ex3										
R3132x10Ex	VDD=VDET-0.1V IOL=+20μA	0.3	VDD≥VDET+0.1	0.75× VDD	VDD≥VDET+0.1	0.2× VDD	Topt=25°C	0.5	1.0	4.0
R3132x11Ex										
R3132x12Ex										
R3132x13Ex										
R3132x14Ex										
R3132x15Ex										
R3132x16Ex										
R3132x17Ex										
R3132x18Ex										
R3132x19Ex										
R3132x20Ex										
R3132x21Ex										
R3132x22Ex										
R3132x23Ex										
R3132x24Ex										
R3132x25Ex										
R3132x26Ex										
R3132x27Ex										
R3132x28Ex										
R3132x29Ex										
R3132x30Ex	VDD=VDET-0.1V IOL=+1.2mA	0.3	VDD≥VDET+0.1	0.75× VDD	VDD≥VDET+0.1	0.2× VDD	Topt=25°C	0.5	1.0	4.0
R3132x31Ex										
R3132x32Ex										
R3132x33Ex										
R3132x34Ex										
R3132x35Ex										
R3132x36Ex										
R3132x37Ex										
R3132x38Ex										
R3132x39Ex										
R3132x40Ex										
R3132x41Ex										
R3132x42Ex										
R3132x43Ex										
R3132x44Ex										
R3132x45Ex										
R3132x46Ex										
R3132x47Ex										
R3132x48Ex										
R3132x49Ex										
R3132x50Ex	VDD=VDET-0.1V IOL=+3.2mA	0.4	VDD≥VDET+0.1	0.75× VDD	VDD≥VDET+0.1	0.2× VDD	Topt=25°C	0.5	1.0	4.0
R3132x31Ex										
R3132x32Ex										
R3132x33Ex										
R3132x34Ex										
R3132x35Ex										
R3132x36Ex										
R3132x37Ex										
R3132x38Ex										
R3132x39Ex										
R3132x40Ex										
R3132x41Ex										
R3132x42Ex										
R3132x43Ex										
R3132x44Ex										
R3132x45Ex										
R3132x46Ex										
R3132x47Ex										
R3132x48Ex										
R3132x49Ex										
R3132x50Ex										

* R3133Q (SC-82AB) is the discontinued product as of March, 2016.

R3132x/R3133x

Output Delay Time for Release				Detector Threshold Temperature Coefficient	
Tdelay[ms]				$\Delta V_{DET}/\Delta T_{opt}$ [ppm/°C]	
Conditions	Min.	Typ.	Max.	Conditions	Typ.
VDD=0.8V→ VDET+1.0V Topt=25°C	204	240	276	-40°C≤Topt≤85°C	±100
VDD=0.8V→ VDET+1.0V Topt=25°C	204	240	276	-40°C≤Topt≤85°C	±100

* R3133Q (SC-82AB) is the discontinued product as of March, 2016.

R3132x/R3133x

● R3133x

Part Number	Operating Voltage				Detector Threshold			Supply Current 1		
	V _{DD} [V]				V _{DET} [V]			I _{SS1} [μA]		
	Conditions	Min.	Conditions	Min.	Min.	Typ.	Max.	Conditions	Typ.	Max.
R3133x23Ex2	T _{opt} =25°C	0.80	-40°C≤T _{opt} ≤85°C	0.90	2.274	2.320	2.366	V _{DD} =V _{DET} -0.1V I _{OUT} =0A	0.8	2.0
R3133x26Ex3					2.578	2.630	2.682			
R3133x29Ex3					2.872	2.930	2.988			
R3133x30Ex8					3.019	3.080	3.141			
R3133x43Ex8					4.293	4.380	4.467			
R3133x46Ex3					4.538	4.630	4.722			
R3133x10Ex	T _{opt} =25°C	0.80	-40°C≤T _{opt} ≤85°C	0.90	0.980	1.000	1.020	V _{DD} =V _{DET} -0.1V I _{OUT} =0A	0.8	2.0
R3133x11Ex					1.078	1.100	1.122			
R3133x12Ex					1.176	1.200	1.224			
R3133x13Ex					1.274	1.300	1.326			
R3133x14Ex					1.372	1.400	1.428			
R3133x15Ex					1.470	1.500	1.530			
R3133x16Ex					1.568	1.600	1.632			
R3133x17Ex					1.666	1.700	1.734			
R3133x18Ex					1.764	1.800	1.836			
R3133x19Ex					1.862	1.900	1.938			
R3133x20Ex					1.960	2.000	2.040			
R3133x21Ex					2.058	2.100	2.142			
R3133x22Ex					2.156	2.200	2.244			
R3133x23Ex					2.254	2.300	2.346			
R3133x24Ex					2.352	2.400	2.448			
R3133x25Ex					2.450	2.500	2.550			
R3133x26Ex					2.548	2.600	2.652			
R3133x27Ex					2.646	2.700	2.754			
R3133x28Ex					2.744	2.800	2.856			
R3133x29Ex					2.842	2.900	2.958			
R3133x30Ex					2.940	3.000	3.060	V _{DD} =V _{DET} -0.1V I _{OUT} =0A	0.9	
R3133x31Ex					3.038	3.100	3.162			
R3133x32Ex					3.136	3.200	3.264			
R3133x33Ex					3.234	3.300	3.366			
R3133x34Ex					3.332	3.400	3.468			
R3133x35Ex					3.430	3.500	3.570			
R3133x36Ex					3.528	3.600	3.672			
R3133x37Ex					3.626	3.700	3.774			
R3133x38Ex					3.724	3.800	3.876			
R3133x39Ex					3.822	3.900	3.978			
R3133x40Ex	3.920	4.000	4.080							
R3133x41Ex	4.018	4.100	4.182							
R3133x42Ex	4.116	4.200	4.284							
R3133x43Ex	4.214	4.300	4.386							
R3133x44Ex	4.312	4.400	4.488							
R3133x45Ex	4.410	4.500	4.590							
R3133x46Ex	4.508	4.600	4.692							
R3133x47Ex	4.606	4.700	4.794							
R3133x48Ex	4.704	4.800	4.896							
R3133x49Ex	4.802	4.900	4.998							
R3133x50Ex	4.900	5.000	5.100							

* R3133Q (SC-82AB) is the discontinued product as of March, 2016.

R3132x/R3133x

Supply Current 2			Supply Current 3			"H" Output Voltage	
Iss2[μ A]			Iss3[μ A]			Voh[V]	
Conditions	Typ.	Max.	Conditions	Typ.	Max.	Conditions	Min.
VDD=VDET+0.1V IOUT=0A	0.8	2.0	VDD=6.0V IOUT=0A	1.2	3.0	VDD=VDET-0.1V IOH=-500 μ A	0.8 \times VDD
				1.0	2.5	VDD=VDET-0.1V IOH=-800 μ A	
VDD=VDET+0.1V IOUT=0A	0.8	2.0	VDD=6.0V IOUT=0A	1.4	3.6	VDD=VDET-0.1V IOH=-10 μ A	0.8 \times VDD
					VDD=VDET-0.1V IOH=-100 μ A		
				1.2	3.0	VDD=VDET-0.1V IOH=-500 μ A	
					VDD=VDET-0.1V IOH=-800 μ A		
				1.0	2.5	VDD=VDET-0.1V IOH=-800 μ A	

* R3133Q (SC-82AB) is the discontinued product as of March, 2016.

R3132x/R3133x

Part Number	"L" Output Voltage		MR pin "H" Input Voltage		MR pin "L" Input Voltage		MR pin pull-up resistance			
	V _{OL} [V]		V _{IH} [V]		V _{IL} [V]		R _{MR} [MΩ]			
	Conditions	Max.	Conditions	Min.	Conditions	Max.	Conditions	Min.	Typ.	Max.
R3133x23Ex2	V _{DD} =V _{DET} +0.1V I _{OL} =+1.2mA	0.3	V _{DD} ≥V _{DET} +0.1	0.75× V _{DD}	V _{DD} ≥V _{DET} +0.1	0.2× V _{DD}	T _{opt} =25°C	0.5	1.0	4.0
R3133x26Ex3										
R3133x29Ex3										
R3133x30Ex8										
R3133x43Ex8	V _{DD} =V _{DET} +0.1V I _{OL} =+3.2mA	0.4	V _{DD} ≥V _{DET} +0.1	0.75× V _{DD}	V _{DD} ≥V _{DET} +0.1	0.2× V _{DD}	T _{opt} =25°C	0.5	1.0	4.0
R3133x46Ex3										
R3133x10Ex	V _{DD} =V _{DET} +0.1V I _{OL} =+20μA	0.3	V _{DD} ≥V _{DET} +0.1	0.75× V _{DD}	V _{DD} ≥V _{DET} +0.1	0.2× V _{DD}	T _{opt} =25°C	0.5	1.0	4.0
R3133x11Ex										
R3133x12Ex	V _{DD} =V _{DET} +0.1V I _{OL} =+750μA	0.3	V _{DD} ≥V _{DET} +0.1	0.75× V _{DD}	V _{DD} ≥V _{DET} +0.1	0.2× V _{DD}	T _{opt} =25°C	0.5	1.0	4.0
R3133x13Ex										
R3133x14Ex										
R3133x15Ex										
R3133x16Ex										
R3133x17Ex										
R3133x18Ex										
R3133x19Ex										
R3133x20Ex										
R3133x21Ex										
R3133x22Ex	V _{DD} =V _{DET} +0.1V I _{OL} =+1.2mA	0.3	V _{DD} ≥V _{DET} +0.1	0.75× V _{DD}	V _{DD} ≥V _{DET} +0.1	0.2× V _{DD}	T _{opt} =25°C	0.5	1.0	4.0
R3133x23Ex										
R3133x24Ex										
R3133x25Ex										
R3133x26Ex										
R3133x27Ex										
R3133x28Ex										
R3133x29Ex										
R3133x30Ex										
R3133x31Ex										
R3133x32Ex										
R3133x33Ex										
R3133x34Ex										
R3133x35Ex										
R3133x36Ex										
R3133x37Ex										
R3133x38Ex										
R3133x39Ex										
R3133x40Ex										
R3133x41Ex										
R3133x42Ex										
R3133x43Ex										
R3133x44Ex										
R3133x45Ex										
R3133x46Ex										
R3133x47Ex										
R3133x48Ex										
R3133x49Ex										
R3133x50Ex										

* R3133Q (SC-82AB) is the discontinued product as of March, 2016.

R3132x/R3133x

Output Delay Time for Release				Detector Threshold Temperature Coefficient	
Tdelay[ms]				$\Delta V_{DET}/\Delta T_{opt}$ [ppm/°C]	
Conditions	Min.	Typ.	Max.	Conditions	Typ.
V _{DD} =0.8V→ V _{DET} +1.0V T _{opt} =25°C	204	240	276	-40°C≤T _{opt} ≤85°C	±100
V _{DD} =0.8V→ V _{DET} +1.0V T _{opt} =25°C	204	240	276	-40°C≤T _{opt} ≤85°C	±100

R3132x/R3133x

OPERATION

• Operation of R3132x Series



- CMOS Output Type:
OUT pin is connected to the drain of Nch Tr. and Pch Tr. in this IC.
- Nch Open Drain Output Type:
OUT pin is connected to the drain of Nch Tr. in this IC.
(OUT pin should be pulled up to V_{DD} or an external voltage level.)

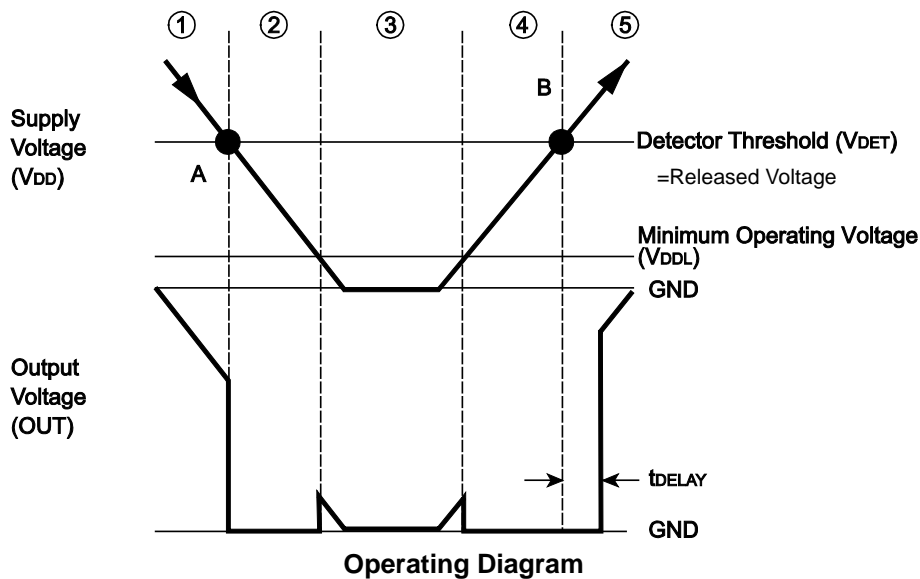

In the above diagram,

- ① Output voltage becomes equal to supply voltage (Nch open drain output type; equal to pull-up Voltage).
 - ② When the supply voltage is down to the detector threshold level (Point A), $V_{ref} \geq V_{DD} \times R_b / (R_a + R_b)$ is true. Then, the output of the comparator is reversed, thus output voltage becomes equal to GND level.
 - ③ When the supply voltage is lower than minimum operating voltage, the output of transistor is indefinite, therefore the output is also indefinite.
 - ④ Output voltage is equal to GND level.
 - ⑤ When the supply voltage is higher than the released voltage (Point B), $V_{ref} \leq V_{DD} \times R_b / (R_a + R_b)$ is true. Then the output of the comparator is reversed, thus the output voltage becomes equal to the supply voltage (Nch open drain output type; equal to pull-up voltage).
- * There is no hysteresis range between the detector threshold and the released voltage.

• Operation of R3133x Series

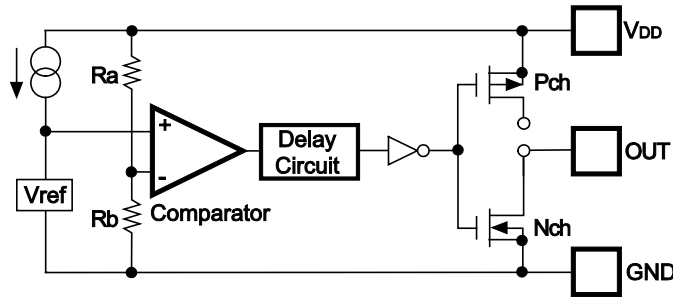

Block Diagram

- CMOS Output Type:
Out pin is connected to the drain of Nch Tr. and Pch Tr. in this IC.
- Nch Open Drain Output Type:
Out pin is connected to the drain of Nch Tr. in this IC.
(OUT pin should be pulled up to V_{DD} or an external voltage level.)

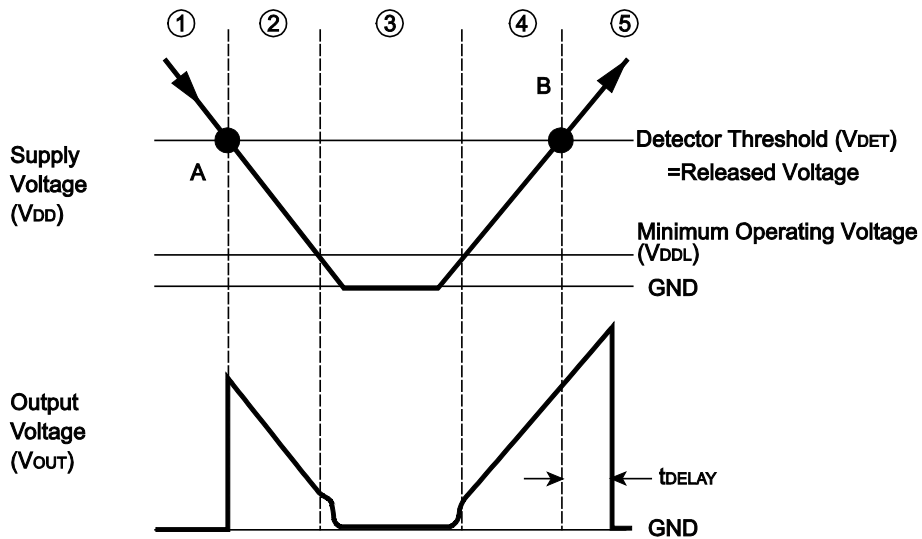

Operation Diagram

In the above diagram,

- ① Output voltage becomes equal to GND level.
- ② When the supply voltage is down to the detector threshold level (Point A), $V_{ref} \geq V_{DD} \times R_b / (R_a + R_b)$ is true. Then, the output of the comparator is reversed, thus output voltage becomes equal to the supply voltage (Nch open drain output type; equal to pull-up voltage).
- ③ When the supply voltage is lower than minimum operating voltage, the output of transistor is indefinite, therefore the output is also indefinite. (Nch open drain output type; the output voltage level is equal to pull-up voltage.)
- ④ Output voltage is equal to the supply voltage. (Nch open drain output type; equal to pull-up Voltage.)
- ⑤ When the supply voltage is higher than the released voltage (Point B), $V_{ref} \leq V_{DD} \times R_b / (R_a + R_b)$ is true. Then the output of the comparator is reversed, thus the output voltage becomes equal to GND level after the output delay time.

* There is no hysteresis range between the detector threshold and the released voltage.

R3132x/R3133x

TECHNICAL NOTES

When the IC is released, if a large pulse (glitch) which crosses the detector threshold voltage is in, the IC may not maintain the released condition. The amplitude of the pulse ($V_{DET}-V_{DDmin}$) and the pulse width the IC can maintain the released level is described in the graph as follows:

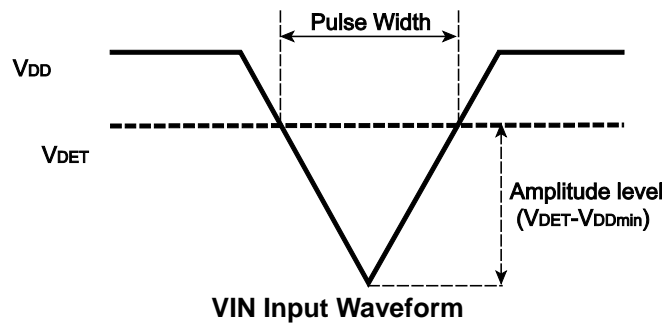

Notes:

The graph above shows the condition for the maximum transient duration without generating a reset. If the larger amplitude or larger pulse width noise than the graph may be on the V_{DD} , the reset signal may be generated.

When connecting resistors to the device's input pin

When connecting a resistor (R1) to an input of this device, the input voltage decreases by [Device's Consumption Current] x [Resistance Value] only. And, the cross conduction current*¹, which occurs when changing from the detecting state to the release state, is decreased the input voltage by [Cross Conduction Current] x [Resistance Value] only. And then, this device will enter the re-detecting state if the input voltage reduction is larger than the difference between the detector voltage and the released voltage.

When the input resistance value is large and the VDD is gone up at mildly in the vicinity of the released voltage, repeating the above operation may result in the occurrence of output.

As shown in Figure A/B, set R1 to become 100 kΩ or less as a guide, and connect C_{IN} of 0.1 μF and more to between the input pin and GND. Besides, make evaluations including temperature properties under the actual usage condition, with using the evaluation board like this way. As a result, make sure that the cross conduction current has no problem.



Figure A



Figure B

*¹ In the CMOS output type, a charging current for OUT pin is included.

*² Note the bias dependence of capacitors.

R3132x/R3133x

TEST CIRCUITS



Supply Current Test Circuit

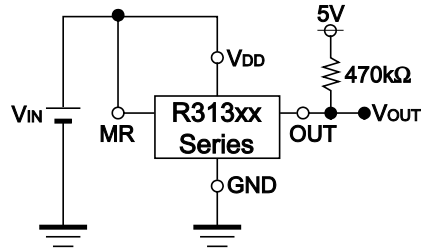

Detector Threshold Test Circuit
(CMOS Output type; pull-up part is not necessary.)



"H" Output Voltage Test Circuit
(CMOS Output Type only)

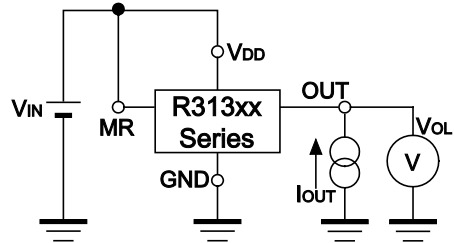

"L" Output Voltage Test Circuit

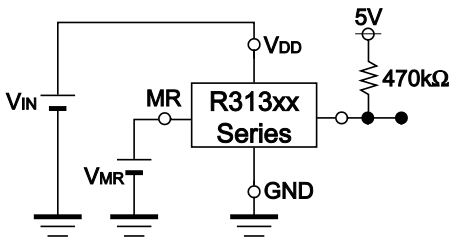

MR pin Input Voltage Test Circuit
(CMOS Output type; pull-up part is not necessary.)

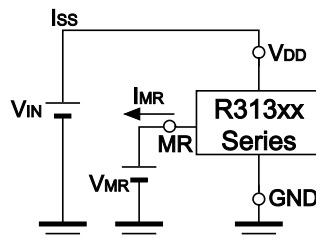

MR pin Pull-up Resistance Test Circuit



Off Leakage Current Test Circuit

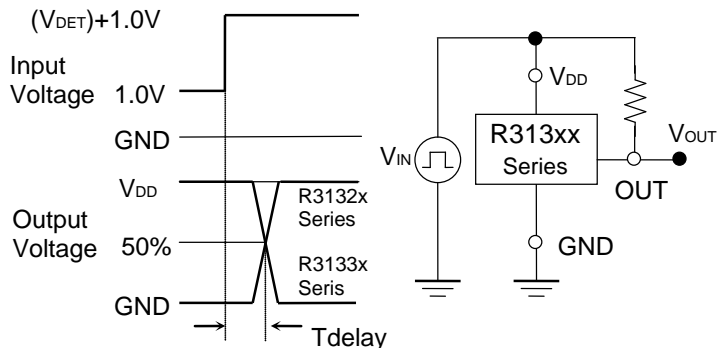

Output Delay Time Test Circuit
(CMOS Output type; pull-up is not necessary.)

TYPICAL CHARACTERISTICS

1) Supply Current vs. Input Voltage

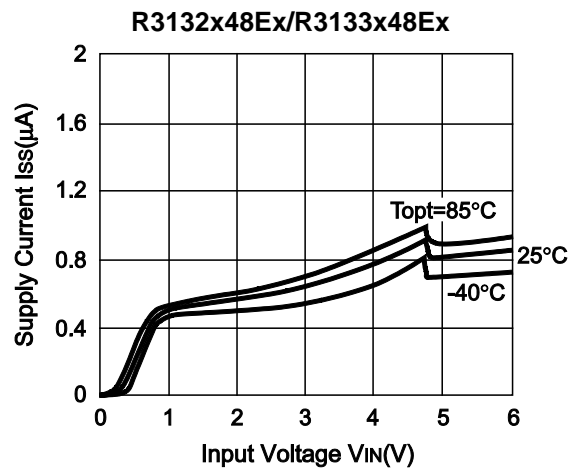
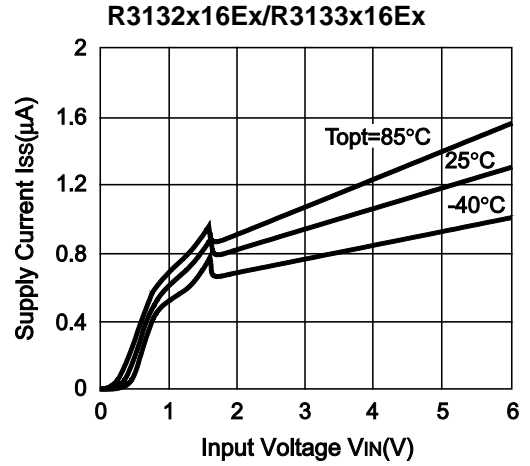

2) Detector Threshold vs. Temperature

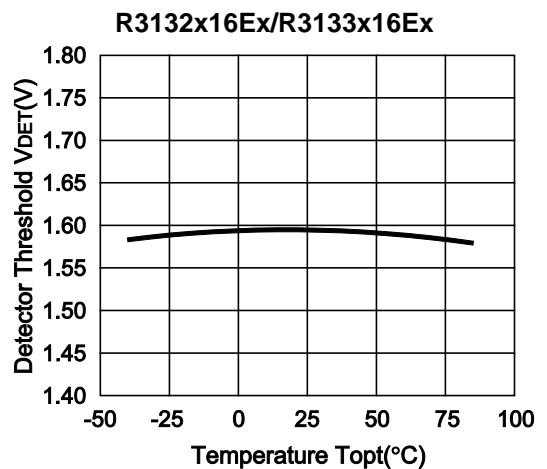

* R3133Q (SC-82AB) is the discontinued product as of March, 2016.

R3132x/R3133x



3) Nch Driver Output Current vs. V_{DS} (Topt=25°C)

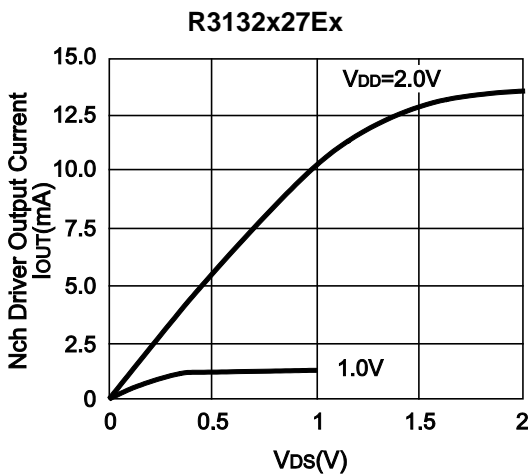
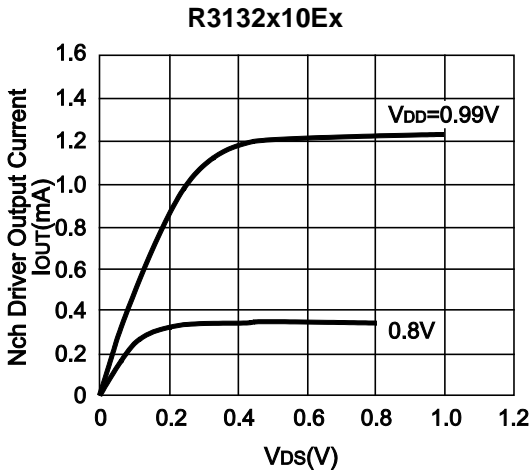

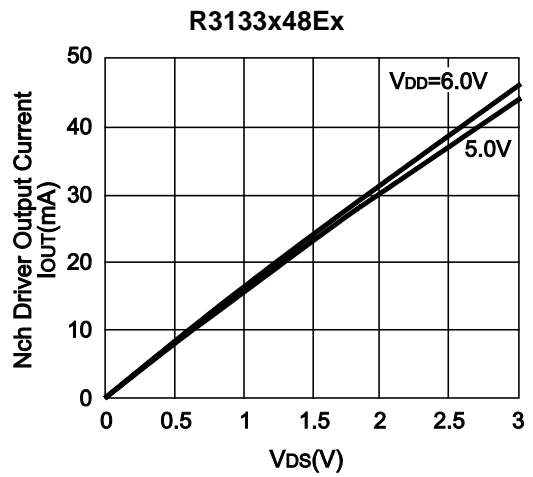

4) Nch Driver Output Current vs. Input Voltage ($V_{DS}=0.5V$)

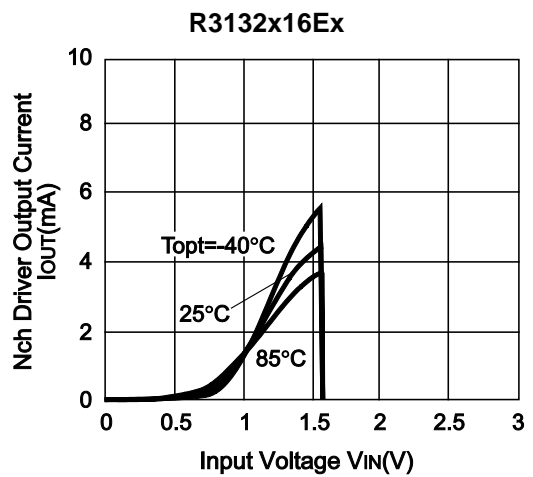

R3132x/R3133x



5) Pch Driver Output Current vs. Input Voltage



* R3133Q (SC-82AB) is the discontinued product as of March, 2016.

R3132x/R3133x



6) Output Delay Time at Detection Mode vs. Temperature



7) Power-on Reset Delay Time vs. Temperature

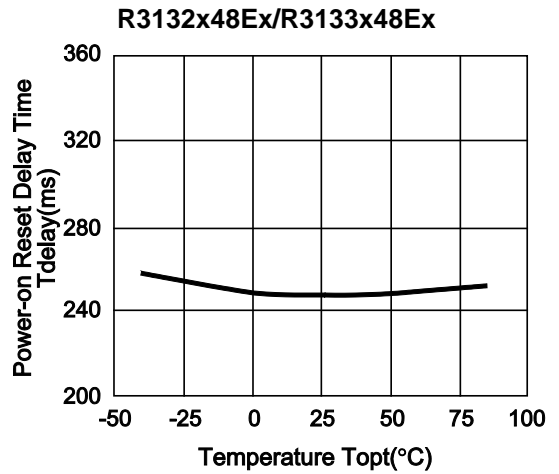
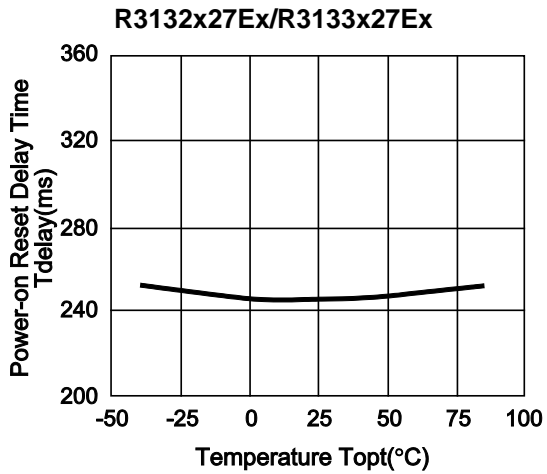
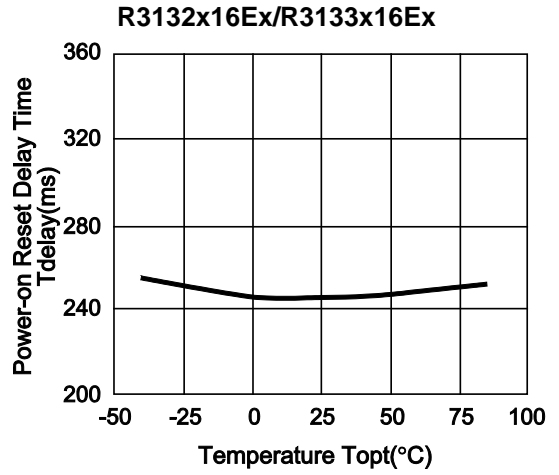
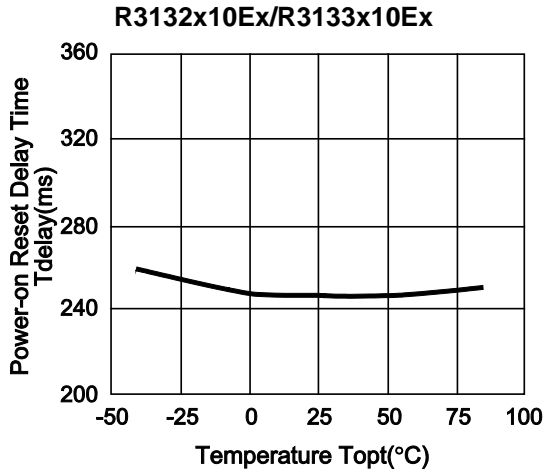



1. The products and the product specifications described in this document are subject to change or discontinuation of production without notice for reasons such as improvement. Therefore, before deciding to use the products, please refer to Ricoh sales representatives for the latest information thereon.
2. The materials in this document may not be copied or otherwise reproduced in whole or in part without prior written consent of Ricoh.
3. Please be sure to take any necessary formalities under relevant laws or regulations before exporting or otherwise taking out of your country the products or the technical information described herein.
4. The technical information described in this document shows typical characteristics of and example application circuits for the products. The release of such information is not to be construed as a warranty of or a grant of license under Ricoh's or any third party's intellectual property rights or any other rights.
5. The products listed in this document are intended and designed for use as general electronic components in standard applications (office equipment, telecommunication equipment, measuring instruments, consumer electronic products, amusement equipment etc.). Those customers intending to use a product in an application requiring extreme quality and reliability, for example, in a highly specific application where the failure or misoperation of the product could result in human injury or death (aircraft, spacevehicle, nuclear reactor control system, traffic control system, automotive and transportation equipment, combustion equipment, safety devices, life support system etc.) should first contact us.
6. We are making our continuous effort to improve the quality and reliability of our products, but semiconductor products are likely to fail with certain probability. In order to prevent any injury to persons or damages to property resulting from such failure, customers should be careful enough to incorporate safety measures in their design, such as redundancy feature, fire containment feature and fail-safe feature. We do not assume any liability or responsibility for any loss or damage arising from misuse or inappropriate use of the products.
7. Anti-radiation design is not implemented in the products described in this document.
8. Please contact Ricoh sales representatives should you have any questions or comments concerning the products or the technical information.



Ricoh is committed to reducing the environmental loading materials in electrical devices with a view to contributing to the protection of human health and the environment.

Ricoh has been providing RoHS compliant products since April 1, 2006 and Halogen-free products since April 1, 2012.

RICOH RICOH ELECTRONIC DEVICES CO., LTD.

<http://www.e-devices.ricoh.co.jp/en/>

Sales & Support Offices

RICOH ELECTRONIC DEVICES CO., LTD.

Higashi-Shinagawa Office (International Sales)
3-32-3, Higashi-Shinagawa, Shinagawa-ku, Tokyo 140-8655, Japan
Phone: +81-3-5479-2857 Fax: +81-3-5479-0502

RICOH EUROPE (NETHERLANDS) B.V.

Semiconductor Support Centre
Prof. W.H. Keesomlaan 1, 1183 DJ Amstelveen, The Netherlands
Phone: +31-20-5474-309

RICOH INTERNATIONAL B.V. - German Branch

Semiconductor Sales and Support Centre
Oberrather Strasse 6, 40472 Düsseldorf, Germany
Phone: +49-211-6546-0

RICOH ELECTRONIC DEVICES KOREA CO., LTD.

3F, Haesung Bldg, 504, Teheran-ro, Gangnam-gu, Seoul, 135-725, Korea
Phone: +82-2-2135-5700 Fax: +82-2-2051-5713

RICOH ELECTRONIC DEVICES SHANGHAI CO., LTD.

Room 403, No.2 Building, No.690 Bibo Road, Pu Dong New District, Shanghai 201203, People's Republic of China
Phone: +86-21-5027-3200 Fax: +86-21-5027-3299

RICOH ELECTRONIC DEVICES CO., LTD.

Taipei office
Room 109, 10F-1, No.51, Hengyang Rd., Taipei City, Taiwan (R.O.C.)
Phone: +886-2-2313-1621/1622 Fax: +886-2-2313-1623

Mouser Electronics

Authorized Distributor

Click to View Pricing, Inventory, Delivery & Lifecycle Information:

Ricoh Electronics:

[R3132Q18EA-TR-FE](#) [R3132Q30EA8-TR-FE](#) [R3132Q45EA-TR-FE](#) [R3132Q42EA-TR-FE](#) [R3132Q28EA-TR-FE](#)
[R3132Q26EC3-TR-FE](#) [R3132Q12EA-TR-FE](#)

Компания «Океан Электроники» предлагает заключение долгосрочных отношений при поставках импортных электронных компонентов на взаимовыгодных условиях!

Наши преимущества:

- Поставка оригинальных импортных электронных компонентов напрямую с производств Америки, Европы и Азии, а так же с крупнейших складов мира;
- Широкая линейка поставок активных и пассивных импортных электронных компонентов (более 30 млн. наименований);
- Поставка сложных, дефицитных, либо снятых с производства позиций;
- Оперативные сроки поставки под заказ (от 5 рабочих дней);
- Экспресс доставка в любую точку России;
- Помощь Конструкторского Отдела и консультации квалифицированных инженеров;
- Техническая поддержка проекта, помощь в подборе аналогов, поставка прототипов;
- Поставка электронных компонентов под контролем ВП;
- Система менеджмента качества сертифицирована по Международному стандарту ISO 9001;
- При необходимости вся продукция военного и аэрокосмического назначения проходит испытания и сертификацию в лаборатории (по согласованию с заказчиком);
- Поставка специализированных компонентов военного и аэрокосмического уровня качества (Xilinx, Altera, Analog Devices, Intersil, Interpoint, Microsemi, Actel, Aeroflex, Peregrine, VPT, Syfer, Eurofarad, Texas Instruments, MS Kennedy, Miteq, Cobham, E2V, MA-COM, Hittite, Mini-Circuits, General Dynamics и др.);

Компания «Океан Электроники» является официальным дистрибьютором и эксклюзивным представителем в России одного из крупнейших производителей разъемов военного и аэрокосмического назначения «**JONHON**», а так же официальным дистрибьютором и эксклюзивным представителем в России производителя высокотехнологичных и надежных решений для передачи СВЧ сигналов «**FORSTAR**».



JONHON

«**JONHON**» (основан в 1970 г.)

Разъемы специального, военного и аэрокосмического назначения:

(Применяются в военной, авиационной, аэрокосмической, морской, железнодорожной, горно- и нефтедобывающей отраслях промышленности)

«**FORSTAR**» (основан в 1998 г.)

ВЧ соединители, коаксиальные кабели,
кабельные сборки и микроволновые компоненты:

(Применяются в телекоммуникациях гражданского и специального назначения, в средствах связи, РЛС, а так же военной, авиационной и аэрокосмической отраслях промышленности).



Телефон: 8 (812) 309-75-97 (многоканальный)

Факс: 8 (812) 320-03-32

Электронная почта: ocean@oceanchips.ru

Web: <http://oceanchips.ru/>

Адрес: 198099, г. Санкт-Петербург, ул. Калинина, д. 2, корп. 4, лит. А