

Metallized Polypropylene Film EMI Suppression Capacitors – F872, Class X1, 480 VAC

Overview

The F872 Series is constructed of metallized polypropylene film encapsulated with self-extinguishing resin in a box of material meeting the requirements of UL 94 V-0.

Applications

For worldwide use as electromagnetic interference (EMI) suppression filter in across-the-line applications requiring X1 safety classification.

Benefits

- Approvals: ENEC, UL, cUL, CQC
- Rated voltage: 480 VAC 50/60 Hz
- Capacitance range: 0.001 – 3.5 μ F
- Lead spacing: 10 – 37.5 mm
- Capacitance tolerance: \pm 20%, \pm 10%
- Climatic category: 40/110/56, IEC 60068-1
- Tape & Reel in accordance with IEC 60286-2
- RoHS Compliant and lead-free terminations
- Operating temperature range of -40°C to $+110^{\circ}\text{C}$
- 100% screening factory test at 3,000 VDC

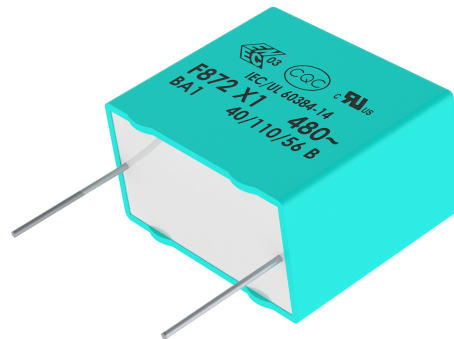

Part Number System

F	872	B	S	104	M	480	C
Capacitor Class	Series	Lead Spacing (mm)	Size Code	Capacitance Code (pF)	Capacitance Tolerance	Voltage (VAC)	Packaging
F = Film	X1, Metallized Polypropylene	A = 10 B = 15 D = 22.5 F = 27.5 R = 37.5	See Dimension Table	First two digits represent significant figures. Third digit specifies number of zeros.	K = \pm 10% M = \pm 20%	480	See Ordering Options Table

Ordering Options Table

Lead Spacing Nominal (mm)	Type of Leads and Packaging	Lead Length (mm)	Lead and Packaging Code
10	Standard Lead and Packaging Options		
	Bulk (Bag) – Short Leads	4+2/-0	C
	Bulk (Bag) – Long Leads	17+0/-1	A
	Tape & Reel (Standard Reel)	H ₀ = 18.5±0.5	L
	Other Lead and Packaging Options		
	Bulk (Bag) – Maximum Length Leads	20+5/-0	ALL0L
	Tape & Reel (Large Reel)	H ₀ = 18.5±0.5	P
15	Standard Lead and Packaging Options		
	Bulk (Bag) – Short Leads	4+2/-0	C
	Bulk (Bag) – Long Leads	17+0/-1	A
	Tape & Reel (Standard Reel)	H ₀ = 18.5±0.5	L
	Pizza Pack	4+2/-0	Z
	Other Lead and Packaging Options		
	Bulk (Bag) – Maximum Length Leads	25+5/-0	ALR0L
	Tape & Reel (Large Reel)	H ₀ = 18.5±0.5	P
22.5	Standard Lead and Packaging Options		
	Pizza – Long Leads	17+0/-1	ZLH0J
	Pizza Pack	4+2/-0	Z
	Other Lead and Packaging Options		
	Tape & Reel (Standard Reel)	H ₀ = 18.5±0.5	L
	Tape & Reel (Large Reel)	H ₀ = 18.5±0.5	P
27.5	Standard Lead and Packaging Options		
	Pizza – Long Leads	17+0/-1	ZLH0J
	Pizza Pack	4+2/-0	Z
37.5	Standard Lead and Packaging Options		
	Pizza – Long Leads	17+0/-1	ZLH0J
	Pizza Pack	4+2/-0	Z

Dimensions – Millimeters



Size Code	Version	S		B		H		L		d	
		Nominal	Tolerance	Nominal	Tolerance	Nominal	Tolerance	Nominal	Tolerance	Nominal	Tolerance
AG		10.0	±0.4	4.0	+0/-0.5	9.0	+0/-0.5	13.0	+0/-0.5	0.6	±0.05
AK		10.0	±0.4	5.0	+0/-0.5	11.0	+0/-0.5	13.0	+0/-0.5	0.6	±0.05
AP		10.0	±0.4	6.0	+0/-0.5	12.0	+0/-0.5	13.0	+0/-0.5	0.6	±0.05
AO		10.0	±0.4	7.0	+0/-0.5	17.0	+0/-0.5	13.0	+0/-0.5	0.6	±0.05
AL	Low Profile	10.0	±0.4	9.5	+0/-0.5	7.5	+0/-0.5	13.0	+0/-0.5	0.6	±0.05
AE	Special Version	10.0	±0.4	4.0	+0/-0.5	8.0	+0/-0.5	13.0	+0/-0.5	0.6	±0.05
BB		15.0	±0.4	4.0	+0/-0.5	10.0	+0/-0.5	18.0	+0/-0.5	0.8	±0.05
BC		15.0	±0.4	5.0	+0/-0.5	11.0	+0/-0.5	18.0	+0/-0.5	0.8	±0.05
BE		15.0	±0.4	5.5	+0/-0.5	12.5	+0/-0.5	18.0	+0/-0.5	0.8	±0.05
BG		15.0	±0.4	6.0	+0/-0.5	12.0	+0/-0.5	18.0	+0/-0.5	0.8	±0.05
BI	High Profile	15.0	±0.4	6.0	+0/-0.5	17.5	+0/-0.5	18.0	+0/-0.5	0.8	±0.05
BK		15.0	±0.4	7.5	+0/-0.5	13.5	+0/-0.5	18.0	+0/-0.5	0.8	±0.05
BO	High Profile	15.0	±0.4	7.5	+0/-0.5	18.5	+0/-0.5	18.0	+0/-0.5	0.8	±0.05
BP		15.0	±0.4	8.5	+0/-0.5	14.5	+0/-0.5	18.0	+0/-0.5	0.8	±0.05
BT		15.0	±0.4	9.0	+0/-0.5	12.5	+0/-0.5	18.0	+0/-0.5	0.8	±0.05
BS		15.0	±0.4	10.0	+0/-0.5	16.0	+0/-0.5	18.0	+0/-0.5	0.8	±0.05
BY		15.0	±0.4	11.0	+0/-0.5	19.0	+0/-0.5	18.0	+0/-0.5	0.8	±0.05
BZ	Special Version	15.0	±0.4	12.0	+0/-0.5	20.0	+0/-0.5	18.0	+0/-0.5	0.8	±0.05
BR	Low Profile	15.0	±0.4	13.0	+0/-0.5	12.0	+0/-0.5	18.0	+0/-0.5	0.8	±0.05
DB		22.5	±0.4	6.0	+0/-0.5	14.5	+0/-0.5	26.0	+0/-0.5	0.8	±0.05
DI		22.5	±0.4	7.0	+0/-0.5	16.0	+0/-0.5	26.0	+0/-0.5	0.8	±0.05
DH		22.5	±0.4	8.0	+0/-0.5	16.0	+0/-0.5	26.0	+0/-0.5	0.8	±0.05
DJ		22.5	±0.4	8.5	+0/-0.5	17.0	+0/-0.5	26.0	+0/-0.5	0.8	±0.05
DM		22.5	±0.4	9.0	+0/-0.5	18.5	+0/-0.5	26.0	+0/-0.5	0.8	±0.05
DO		22.5	±0.4	10.0	+0/-0.5	18.5	+0/-0.5	26.0	+0/-0.5	0.8	±0.05
DP		22.5	±0.4	11.0	+0/-0.5	20.0	+0/-0.5	26.0	+0/-0.5	0.8	±0.05
DU		22.5	±0.4	13.0	+0/-0.5	22.0	+0/-0.5	26.0	+0/-0.5	0.8	±0.05
DY		22.5	±0.4	15.5	+0/-0.5	24.5	+0/-0.5	26.0	+0/-0.5	0.8	±0.05

Note: See Ordering Options Table for lead length (LL) options.

Dimensions – Millimeters cont.



Size Code	Version	S		B		H		L		d	
		Nominal	Tolerance	Nominal	Tolerance	Nominal	Tolerance	Nominal	Tolerance	Nominal	Tolerance
FB		27.5	±0.4	9.0	+0/-0.7	17.0	+0/-0.7	31.5	+0/-0.7	0.8	±0.05
FC		27.5	±0.4	11.0	+0/-0.7	20.0	+0/-0.7	31.5	+0/-0.7	0.8	±0.05
FI		27.5	±0.4	13.0	+0/-0.7	25.0	+0/-0.7	31.5	+0/-0.7	0.8	±0.05
FN		27.5	±0.4	14.0	+0/-0.7	28.0	+0/-0.7	31.5	+0/-0.7	0.8	±0.05
FO	High Profile	27.5	±0.4	17.0	+0/-0.7	40.0	+0/-0.7	31.5	+0/-0.7	0.8	±0.05
FR		27.5	±0.4	17.5	+0/-0.7	28.0	+0/-0.7	31.5	+0/-0.7	0.8	±0.05
FS		27.5	±0.4	19.0	+0/-0.7	29.0	+0/-0.7	31.5	+0/-0.7	0.8	±0.05
FY		27.5	±0.4	22.0	+0/-0.7	37.0	+0/-0.7	31.5	+0/-0.7	0.8	±0.05
FH	Low Profile	27.5	±0.4	21.0	+0/-0.7	12.5	+0/-0.7	31.5	+0/-0.7	0.8	±0.05
FQ	Low Profile	27.5	±0.4	27.5	+0/-0.7	16.0	+0/-0.7	31.5	+0/-0.7	0.8	±0.05
FT	Low Profile	27.5	±0.4	31.0	+0/-0.7	19.0	+0/-0.7	31.5	+0/-0.7	0.8	±0.05
RB		37.5	±0.4	11.0	+0/-0.7	22.0	+0/-0.7	41.0	+0/-0.7	1.0	±0.05
RF		37.5	±0.4	13.0	+0/-0.7	24.0	+0/-0.7	41.0	+0/-0.7	1.0	±0.05
RH		37.5	±0.4	15.0	+0/-0.7	26.0	+0/-0.7	41.0	+0/-0.7	1.0	±0.05
RC		37.5	±0.4	16.0	+0/-0.7	28.5	+0/-0.7	41.0	+0/-0.7	1.0	±0.05
RD		37.5	±0.4	19.0	+0/-0.7	32.0	+0/-0.7	41.0	+0/-0.7	1.0	±0.05
RP		37.5	±0.4	21.0	+0/-0.7	38.0	+0/-0.7	41.0	+0/-0.7	1.0	±0.05
RO		37.5	±0.4	24.0	+0/-0.7	44.0	+0/-0.7	41.0	+0/-0.7	1.0	±0.05
RU		37.5	±0.4	30.0	+0/-0.7	45.0	+0/-0.7	41.0	+0/-0.7	1.0	±0.05
RV	Low Profile	37.5	±0.4	24.0	+0/-0.7	15.0	+0/-0.7	41.0	+0/-0.7	1.0	±0.05
RW	Low Profile	37.5	±0.4	24.0	+0/-0.7	19.0	+0/-0.7	41.0	+0/-0.7	1.0	±0.05

Note: See Ordering Options Table for lead length (LL) options.

Performance Characteristics

Rated Voltage	480 VAC 50/60 Hz		
Capacitance Range	0.001 – 3.5 μ F		
Capacitance Tolerance	\pm 20%, \pm 10%		
Temperature Range	-40°C to +110°C		
Climatic Category	40/110/56		
Storage Conditions	Storage time: \leq 24 months from the date marked on the label package Average relative humidity per year \leq 70% RH \leq 85% for 30 days randomly distributed throughout the year Dew is absent Temperature: -40 to 80°C (see "Maximum Humidity in Storage Conditions" graph below)		
Approvals	ENEC, UL, cUL, CQC		
Dissipation Factor	Maximum Values at +23°C		
		$C \leq 0.1 \mu$ F	$C > 0.1 \mu$ F
	1 kHz	0.3%	0.2%
Test Voltage Between Terminals	The 100% screening factory test is carried out at 3,000 VDC. The voltage level is selected to meet the requirements in applicable equipment standards. All electrical characteristics are checked after the test. It's not permitted to repeat this Test as there is a risk to damage the Capacitor. KEMET is not liable in such case for any failures.		
Insulation Resistance	Minimum Values Between Terminals		
	$C \leq 0.33 \mu$ F	$\geq 30,000 \text{ M}\Omega$	
	$C > 0.33 \mu$ F	$\geq 10,000 \text{ M}\Omega \cdot \mu$ F	
In DC Applications	Recommended voltage \leq 1,000 VDC		

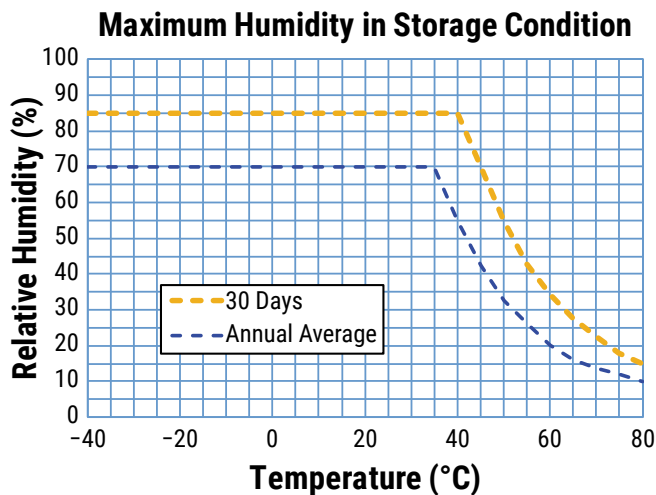

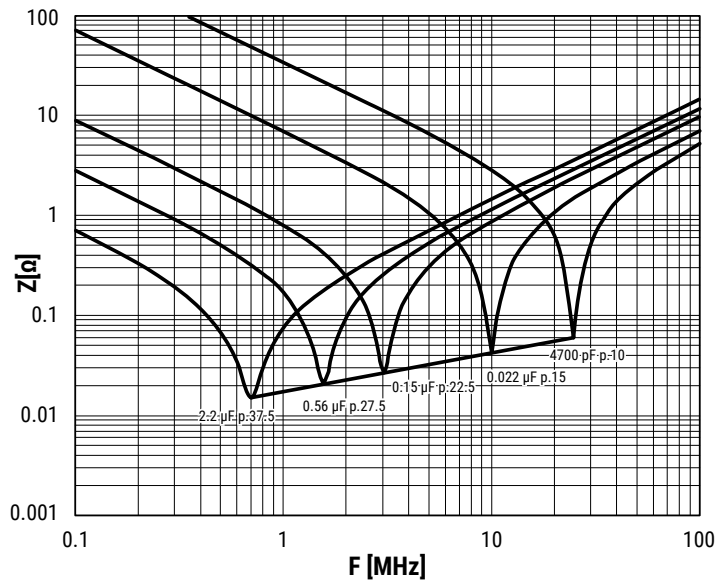

Impedance Graph



Environmental Test Data

Test	IEC Publication	Procedure
Endurance	IEC 60384-14	1.25 x V _R VAC 50 Hz, once every hour increase to 1,000 VAC for 0.1 second, 1,000 hours at upper rated temperature
Vibration	IEC 60068-2-6 Test Fc	3 directions at 2 hours each 10 – 55 Hz at 0.75 mm or 98 m/s ²
Bump	IEC 60068-2-29 Test Eb	1,000 bumps at 390 m/s ²
Change of Temperature	IEC 60068-2-14 Test Na	Upper and lower rated temperature 5 cycles
Active Flammability	IEC 60384-14	V _R + 20 surge pulses at 4 kV (pulse every 5 seconds)
Passive Flammability	IEC 60384-14	IEC 60384-1, IEC 60695-11-5 Needle-flame test
Damp Heat Steady State	IEC 60068-2-78 Test Cab	+40°C and 93% RH, 56 days

Approvals

Mark	Specification	File Number
	EN/IEC 60384-14	CA08.00187
	UL 60384-14 and CAN/CSA-E60384-14	E97797
	IEC 60384-14	CQC12001084716 CQC12001084708 CQC12001084714 CQC12001084713 CQC12001084715 CQC12001088081

Environmental Compliance

All new KEMET EMI capacitors are RoHS compliant and Halogen-Free.



Table 1 – Ratings & Part Number Reference

Capacitance Value (µF)	Size Code	Maximum Dimensions in mm			Lead Spacing (p)	dV/dt (V/µs)	Part Number
		B	H	L			
0.001	AE	4	8	13	10	750	F872AE102(1)480(2)
0.0012	AE	4	8	13	10	750	F872AE122(1)480(2)
0.0015	AE	4	8	13	10	750	F872AE152(1)480(2)
0.0018	AE	4	8	13	10	750	F872AE182(1)480(2)
0.0018	AL	9.5	7.5	13	10	750	F872AL182(1)480(2)
0.0022	AE	4	8	13	10	750	F872AE222(1)480(2)
0.0022	AL	9.5	7.5	13	10	750	F872AL222(1)480(2)
0.0025	AE	4	8	13	10	750	F872AE252(1)480(2)
0.0025	AL	9.5	7.5	13	10	750	F872AL252(1)480(2)
0.0027	AE	4	8	13	10	750	F872AE272(1)480(2)
0.0027	AL	9.5	7.5	13	10	750	F872AL272(1)480(2)
0.0033	AE	4	8	13	10	750	F872AE332(1)480(2)
0.0033	AL	9.5	7.5	13	10	750	F872AL332(1)480(2)
0.0039	AE	4	8	13	10	750	F872AE392(3)480(2)
0.0039	AG	4	9	13	10	750	F872AG392(1)480(2)
0.0039	AL	9.5	7.5	13	10	750	F872AL392(1)480(2)
0.0047	AG	4	9	13	10	750	F872AG472(1)480(2)
0.0047	AL	9.5	7.5	13	10	750	F872AL472(1)480(2)
0.0056	AK	5	11	13	10	750	F872AK562(1)480(2)
0.0056	AL	9.5	7.5	13	10	750	F872AL562(1)480(2)
0.0068	AK	5	11	13	10	750	F872AK682(1)480(2)
0.0068	AL	9.5	7.5	13	10	750	F872AL682(1)480(2)
0.0082	AK	5	11	13	10	750	F872AK822(3)480(2)
0.0082	AL	9.5	7.5	13	10	750	F872AL822(1)480(2)
0.01	AL	9.5	7.5	13	10	750	F872AL103(1)480(2)
0.01	AP	6	12	13	10	750	F872AP103(1)480(2)
0.012	AP	6	12	13	10	750	F872AP123(3)480(2)
0.015	AO	7	17	13	10	750	F872AO153(1)480(2)
0.018	AO	7	17	13	10	750	F872AO183(3)480(2)
0.0027	BB	4	10	18	15	600	F872BB272(1)480(2)
0.0033	BB	4	10	18	15	600	F872BB332(1)480(2)
0.0039	BB	4	10	18	15	600	F872BB392(1)480(2)
0.0047	BB	4	10	18	15	600	F872BB472(1)480(2)
0.0056	BB	4	10	18	15	600	F872BB562(1)480(2)
0.0068	BB	4	10	18	15	600	F872BB682(1)480(2)
0.0082	BB	4	10	18	15	600	F872BB822(1)480(2)
0.01	BB	4	10	18	15	600	F872BB103(1)480(2)
0.012	BB	4	10	18	15	600	F872BB123(1)480(2)
0.015	BB	4	10	18	15	600	F872BB153(1)480(2)
0.015	BT	9	12.5	18	15	600	F872BT153(1)480(2)
0.018	BC	5	11	18	15	600	F872BC183(1)480(2)
0.018	BT	9	12.5	18	15	600	F872BT183(1)480(2)
0.022	BC	5	11	18	15	600	F872BC223(1)480(2)
0.022	BT	9	12.5	18	15	600	F872BT223(1)480(2)
0.025	BE	5.5	12.5	18	15	600	F872BE253(1)480(2)
0.025	BT	9	12.5	18	15	600	F872BT253(1)480(2)
0.027	BE	5.5	12.5	18	15	600	F872BE273(1)480(2)
0.027	BT	9	12.5	18	15	600	F872BT273(1)480(2)
0.033	BE	5.5	12.5	18	15	600	F872BE333(3)480(2)
0.033	BG	6	12	18	15	600	F872BG333(1)480(2)
0.033	BT	9	12.5	18	15	600	F872BT333(1)480(2)
0.039	BI	6	17.5	18	15	600	F872BI393(3)480(2)
0.039	BK	7.5	13.5	18	15	600	F872BK393(1)480(2)
0.039	BR	13	12	18	15	600	F872BR393(1)480(2)
0.039	BT	9	12.5	18	15	600	F872BT393(1)480(2)
0.047	BI	6	17.5	18	15	600	F872BI473(1)480(2)
0.047	BK	7.5	13.5	18	15	600	F872BK473(1)480(2)
0.047	BR	13	12	18	15	600	F872BR473(1)480(2)
Capacitance Value (µF)	Size Code	B (mm)	H (mm)	L (mm)	Lead Spacing (p)	dV/dt (V/µs)	Part Number

(1) M = ±20%, K = ±10%.
 (2) Insert lead and packaging code. See Ordering Options Table for available options.
 (3) M = ±20% (only available tolerance).

Table 1 – Ratings & Part Number Reference cont.

Capacitance Value (µF)	Size Code	Maximum Dimensions in mm			Lead Spacing (p)	dV/dt (V/µs)	Part Number
		B	H	L			
0.047	BT	9	12.5	18	15	600	F872BT473(1)480(2)
0.056	BI	6	17.5	18	15	600	F872BI563(3)480(2)
0.056	BK	7.5	13.5	18	15	600	F872BK563(3)480(2)
0.056	BO	7.5	18.5	18	15	600	F872BO563(1)480(2)
0.056	BP	8.5	14.5	18	15	600	F872BP563(1)480(2)
0.056	BR	13	12	18	15	600	F872BR563(1)480(2)
0.068	BO	7.5	18.5	18	15	600	F872BO683(1)480(2)
0.068	BP	8.5	14.5	18	15	600	F872BP683(3)480(2)
0.068	BR	13	12	18	15	600	F872BR683(1)480(2)
0.082	BO	7.5	18.5	18	15	600	F872BO823(3)480(2)
0.082	BR	13	12	18	15	600	F872BR823(1)480(2)
0.082	BS	10	16	18	15	600	F872BS823(1)480(2)
0.1	BS	10	16	18	15	600	F872BS104(3)480(2)
0.1	BY	11	19	18	15	600	F872BY104(1)480(2)
0.12	BY	11	19	18	15	600	F872BY124(3)480(2)
0.12	BZ	12	20	18	15	600	F872BZ124(1)480(2)
0.15	BZ	12	20	18	15	600	F872BZ154(3)480(2)
0.039	DB	6	14.5	26	22.5	300	F872DB393(1)480(2)
0.047	DB	6	14.5	26	22.5	300	F872DB473(1)480(2)
0.056	DB	6	14.5	26	22.5	300	F872DB563(1)480(2)
0.068	DB	6	14.5	26	22.5	300	F872DB683(1)480(2)
0.082	DI	7	16	26	22.5	300	F872DI823(1)480(2)
0.1	DI	7	16	26	22.5	300	F872DI104(1)480(2)
0.12	DH	8	16	26	22.5	300	F872DH124(1)480(2)
0.12	DI	7	16	26	22.5	300	F872DI124(3)480(2)
0.15	DJ	8.5	17	26	22.5	300	F872DJ154(3)480(2)
0.15	DM	9	18.5	26	22.5	300	F872DM154(1)480(2)
0.18	DM	9	18.5	26	22.5	300	F872DM184(3)480(2)
0.18	DO	10	18.5	26	22.5	300	F872DO184(1)480(2)
0.22	DO	10	18.5	26	22.5	300	F872DO224(3)480(2)
0.22	DP	11	20	26	22.5	300	F872DP224(1)480(2)
0.25	DU	13	22	26	22.5	300	F872DU254(1)480(2)
0.27	DU	13	22	26	22.5	300	F872DU274(1)480(2)
0.33	DU	13	22	26	22.5	300	F872DU334(1)480(2)
0.39	DU	13	22	26	22.5	300	F872DU394(3)480(2)
0.39	DY	15.5	24.5	26	22.5	300	F872DY394(1)480(2)
0.47	DY	15.5	24.5	26	22.5	300	F872DY474(1)480(2)
0.15	FB	9	17	31.5	27.5	225	F872FB154(1)480(2)
0.18	FB	9	17	31.5	27.5	225	F872FB184(1)480(2)
0.22	FC	11	20	31.5	27.5	225	F872FC224(1)480(2)
0.25	FC	11	20	31.5	27.5	225	F872FC254(1)480(2)
0.25	FH	21	12.5	31.5	27.5	225	F872FH254(1)480(2)
0.27	FC	11	20	31.5	27.5	225	F872FC274(1)480(2)
0.27	FH	21	12.5	31.5	27.5	225	F872FH274(1)480(2)
0.33	FC	11	20	31.5	27.5	225	F872FC334(1)480(2)
0.33	FH	21	12.5	31.5	27.5	225	F872FH334(1)480(2)
0.39	FI	13	25	31.5	27.5	225	F872FI394(1)480(2)
0.39	FH	21	12.5	31.5	27.5	225	F872FH394(3)480(2)
0.47	FI	13	25	31.5	27.5	225	F872FI474(1)480(2)
0.56	FQ	27.5	16	31.5	27.5	225	F872FQ564(1)480(2)
0.56	FN	14	28	31.5	27.5	225	F872FN564(1)480(2)
0.68	FQ	27.5	16	31.5	27.5	225	F872FQ684(3)480(2)
0.68	FR	17.5	28	31.5	27.5	225	F872FR684(1)480(2)
0.68	FT	31	19	31.5	27.5	225	F872FT684(1)480(2)
0.82	FR	17.5	28	31.5	27.5	225	F872FR824(1)480(2)
0.82	FS	19	29	31.5	27.5	225	F872FS824(1)480(2)
0.82	FT	31	19	31.5	27.5	225	F872FT824(1)480(2)
0.82	FO	17	40	31.5	27.5	225	F872FO824(1)480(2)
Capacitance Value (µF)	Size Code	B (mm)	H (mm)	L (mm)	Lead Spacing (p)	dV/dt (V/µs)	Part Number

(1) M = ±20%, K = ±10%.
 (2) Insert lead and packaging code. See Ordering Options Table for available options.
 (3) M = ±20% (only available tolerance).

Table 1 – Ratings & Part Number Reference cont.

Capacitance Value (µF)	Size Code	Maximum Dimensions in mm			Lead Spacing (p)	dV/dt (V/µs)	Part Number
		B	H	L			
1	FO	17	40	31.5	27.5	225	F872FO105(1)480(2)
1	FS	19	29	31.5	27.5	225	F872FS105(3)480(2)
1	FY	22	37	31.5	27.5	225	F872FY105(1)480(2)
1	FT	31	19	31.5	27.5	225	F872FT105(1)480(2)
1.2	FO	17	40	31.5	27.5	225	F872FO125(3)480(2)
1.2	FY	22	37	31.5	27.5	225	F872FY125(1)480(2)
1.5	FY	22	37	31.5	27.5	225	F872FY155(3)480(2)
1.8	FY	22	37	31.5	27.5	225	F872FY185(3)480(2)
0.33	RB	11	22	41	37.5	150	F872RB334(1)480(2)
0.39	RB	11	22	41	37.5	150	F872RB394(1)480(2)
0.47	RB	11	22	41	37.5	150	F872RB474(1)480(2)
0.56	RB	11	22	41	37.5	150	F872RB564(1)480(2)
0.56	RV	24	15	41	37.5	150	F872RV564(1)480(2)
0.68	RF	13	24	41	37.5	150	F872RF684(1)480(2)
0.68	RV	24	15	41	37.5	150	F872RV684(1)480(2)
0.82	RH	15	26	41	37.5	150	F872RH824(1)480(2)
0.82	RW	24	19	41	37.5	150	F872RW824(1)480(2)
1	RC	16	28.5	41	37.5	150	F872RC105(1)480(2)
1	RH	15	26	41	37.5	150	F872RH105(3)480(2)
1	RW	24	19	41	37.5	150	F872RW105(1)480(2)
1.2	RD	19	32	41	37.5	150	F872RD125(1)480(2)
1.2	RC	16	28.5	41	37.5	150	F872RC125(3)480(2)
1.2	RW	24	19	41	37.5	150	F872RW125(3)480(2)
1.5	RD	19	32	41	37.5	150	F872RD155(1)480(2)
1.8	RD	19	32	41	37.5	150	F872RD185(3)480(2)
1.8	RP	21	38	41	37.5	150	F872RP185(1)480(2)
2.2	RO	24	44	41	37.5	150	F872RO225(1)480(2)
2.5	RO	24	44	41	37.5	150	F872RO255(1)480(2)
2.7	RO	24	44	41	37.5	150	F872RO275(1)480(2)
3.3	RU	30	45	41	37.5	150	F872RU335(1)480(2)
3.5	RU	30	45	41	37.5	150	F872RU355(3)480(2)
Capacitance Value (µF)	Size Code	B (mm)	H (mm)	L (mm)	Lead Spacing (p)	dV/dt (V/µs)	Part Number

- (1) M = ±20%, K = ±10%.
 (2) Insert lead and packaging code. See Ordering Options Table for available options.
 (3) M = ±20% (only available tolerance).

Soldering Process

The implementation of the RoHS directive has resulted in the selection of SnAgCu (SAC) alloys or SnCu alloys as primary solder. This has increased the liquidus temperature from that of 183°C for SnPb eutectic alloy to 217 – 221°C for the new alloys. As a result, the heat stress to the components, even in wave soldering, has increased considerably due to higher pre-heat and wave temperatures. Polypropylene capacitors are especially sensitive to heat (the melting point of polypropylene is 160 – 170°C). Wave soldering can be destructive, especially for mechanically small polypropylene capacitors (with lead spacing of 5 mm to 15 mm), and great care has to be taken during soldering. The recommended solder profiles from KEMET should be used. Please consult KEMET with any questions. In general, the wave soldering curve from IEC Publication 61760-1 Edition 2 serves as a solid guideline for successful soldering. Please see Figure 1.

Reflow soldering is not recommended for through-hole film capacitors. Exposing capacitors to a soldering profile in excess of the above the recommended limits may result to degradation or permanent damage to the capacitors.

Do not place the polypropylene capacitor through an adhesive curing oven to cure resin for surface mount components. Insert through-hole parts after the curing of surface mount parts. Consult KEMET to discuss the actual temperature profile in the oven, if through-hole components must pass through the adhesive curing process. A maximum two soldering cycles is recommended. Please allow time for the capacitor surface temperature to return to a normal temperature before the second soldering cycle.

Manual Soldering Recommendations

Following is the recommendation for manual soldering with a soldering iron.

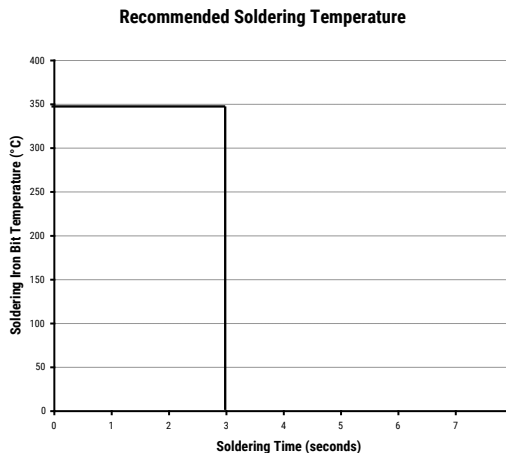

The soldering iron tip temperature should be set at 350°C (+10°C maximum), with the soldering duration not to exceed more than 3 seconds.

Wave Soldering Recommendations

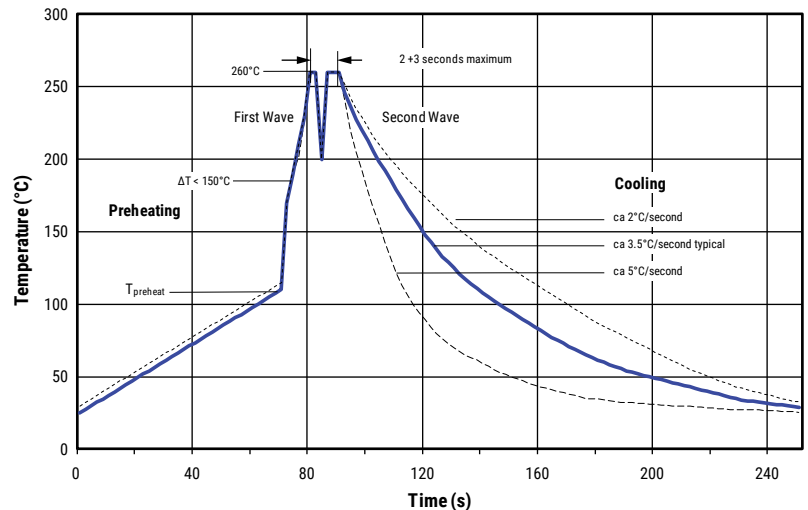

Soldering Process cont.

Wave Soldering Recommendations cont.

1. The table indicates the maximum set-up temperature of the soldering process
 Figure 1

Dielectric Film Material	Maximum Preheat Temperature		Maximum Peak Soldering Temperature	
	Capacitor Pitch ≤ 15 mm	Capacitor Pitch > 15 mm	Capacitor Pitch ≤ 15 mm	Capacitor Pitch > 15 mm
Polyester	130°C	130°C	270°C	270°C
Polypropylene	110°C	130°C	260°C	270°C
Paper	130°C	140°C	270°C	270°C
Polyphenylene Sulphide	150°C	160°C	270°C	270°C

2. The maximum temperature measured inside the capacitor:

Set the temperature so that inside the element the maximum temperature is below the limit:

Dielectric Film Material	Maximum temperature measured inside the element
Polyester	160°C
Polypropylene	110°C
Paper	160°C
Polyphenylene Sulphide	160°C

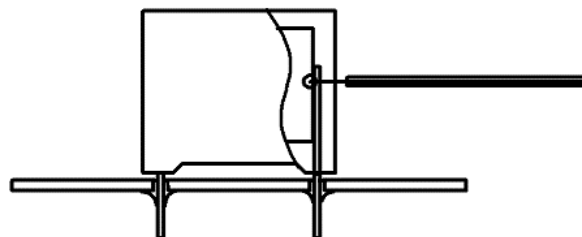

Temperature monitored inside the capacitor.

Selective Soldering Recommendations

Selective dip soldering is a variation of reflow soldering. In this method, the printed circuit board with through-hole components to be soldered is preheated and transported over the solder bath as in normal flow soldering without touching the solder. When the board is over the bath, it is stopped and pre-designed solder pots are lifted from the bath with molten solder only at the places of the selected components, and pressed against the lower surface of the board to solder the components.

The temperature profile for selective soldering is similar to the double wave flow soldering outlined in this document, **however, instead of two baths, there is only one bath with a time from 3 to 10 seconds.** In selective soldering, the risk of overheating is greater than in double wave flow soldering, and great care must be taken so that the parts are not overheated.

Construction

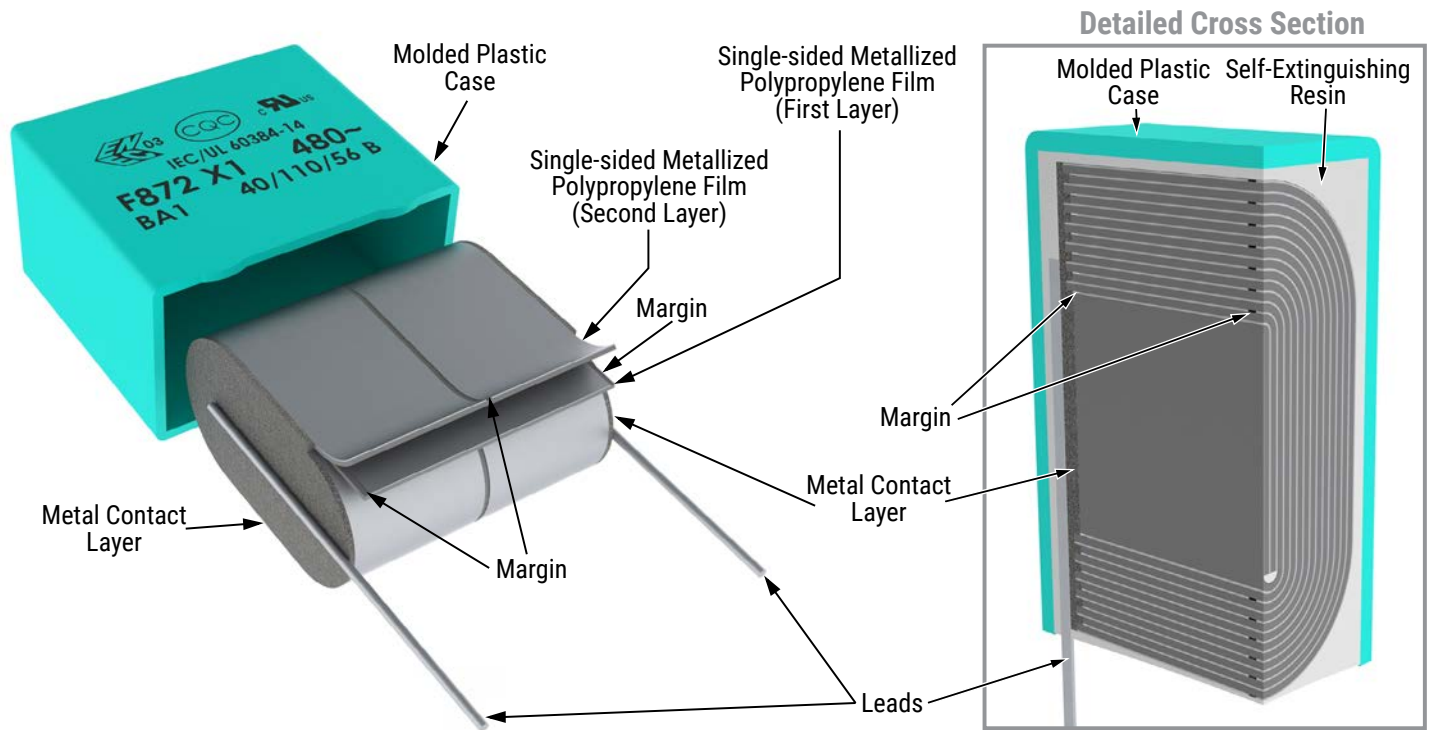

Winding Scheme

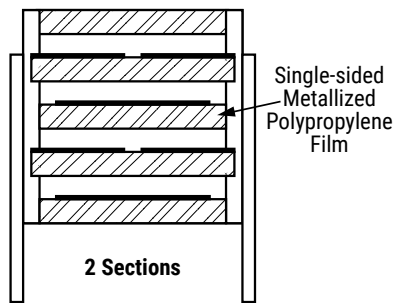

Marking

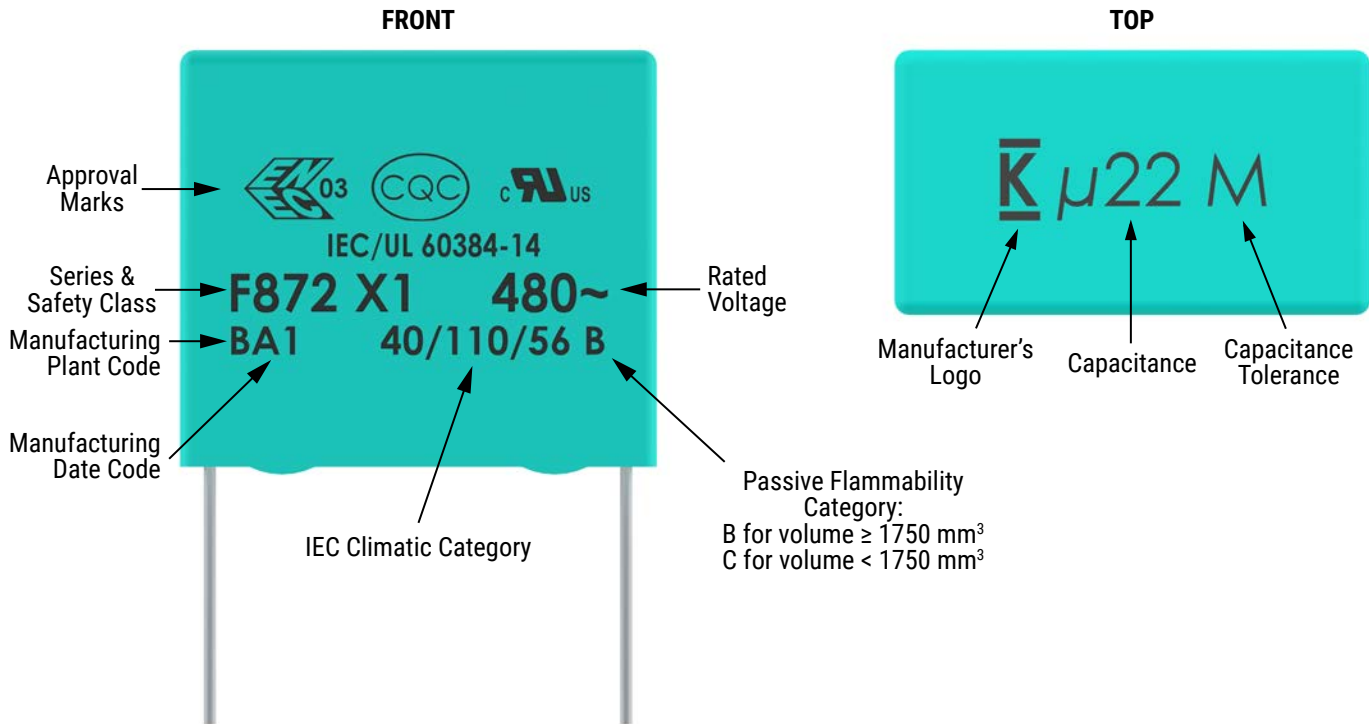

Manufacturing Date Code (IEC-60062)

Y = Year, Z = Month			
Year	Code	Month	Code
2010	A	January	1
2011	B	February	2
2012	C	March	3
2013	D	April	4
2014	E	May	5
2015	F	June	6
2016	H	July	7
2017	J	August	8
2018	K	September	9
2019	L	October	0
2020	M	November	N
2021	N	December	D
2022	P		
2023	R		
2024	S		
2025	T		
2026	U		
2027	V		
2028	W		
2029	X		
2030	A		

Packaging Quantities

Size Code	Lead Spacing	Thickness (mm)	Height (mm)	Length (mm)	Bulk Short Leads	Bulk Long Leads	Standard Reel ø 355 mm	Large Reel ø 500 mm	Ammo	Pizza
AN	10	3.5	9	13	2,000	2,200	850	1,700	1,150	
AG		4	9	13	2,000	2,200	750	1,500	1,000	
AK		5	11	13	1,300	2,000	600	1,250	800	
AP		6	12	13	1,000	1,800	500	1,000	680	
AO		7	17	13	600	700	450	900	580	
AL		9.5	7.5	13	1,000	1,500	300	600	430	
AE		4	8	13	2,000	2,200	750	1,500	1,000	
BB		15	4	10	18	2,500	1,500	750	1,500	1,000
BC	5		11	18	1,000	1,250	600	1,250	800	1,139
BE	5.5		12.5	18	800	1,000	550	1,100	750	1,020
BG	6		12	18	1,750	1,000	500	1,000	680	935
BK	7.5		13.5	18	1,000	800	350	800	500	748
BI	6		17.5	18	1,000	800	500	1,000	680	935
BP	8.5		14.5	18	1,000	650	300	700	440	663
BT	9		12.5	18	1,000	700	270	650	410	629
BO	7.5		18.5	18	900	500	350	800	500	748
BS	10		16	18	750	550	300	600	380	561
BR	13		12	18	750	520	200	480	280	425
BY	11		19	18	450	400	250	500	340	510
BA	8.5		12.5	18	1,000	650	300	700	440	663
BZ	12		20	18	350	300	220	450	330	459
DB	22.5	6	14.5	26	805	450	300	700	464	660
DI		7	16	26	700	450	250	550	380	564
DH		8.0	16.0	26	520	300	240	500	330	492
DJ		8.5	17	26	450	350	250	450	280	468
DM		9	18.5	26	400	225	200	400	300	444
DO		10	18.5	26	360	350	160	350	235	396
DP		11	20	26	300	200	190	350	217	360
DU		13	22	26	230	150	150	300	200	300
DY		15.5	24.5	26	150	100	120	250	170	252

Packaging Quantities cont.

Size Code	Lead Spacing	Thickness (mm)	Height (mm)	Length (mm)	Bulk Short Leads	Bulk Long Leads	Standard Reel ø 355 mm	Large Reel ø 500 mm	Ammo	Pizza
FB	27.5	9.0	17.0	31.5						370
FC		11.0	20.0	31.5						300
FI		13.0	25.0	31.5						250
FN		14.0	28.0	31.5						230
FO		17.0	40.0	31.5						190
FR		17.5	28.0	31.5						190
FS		19.0	29.0	31.5						170
FY		22.0	37.0	31.5						150
FH		21.0	12.5	31.5						150
FQ		27.5	16.0	31.5						120
FT		31.0	19.0	31.5						100
RB		37.5	11.0	22.0	41.0					
RF	13.0		24.0	41.0						175
RH	15.0		26.0	41.0						154
RC	16.0		28.5	41.0						140
RD	19.0		32.0	41.0						119
RP	21.0		38.0	41.0						105
RO	24.0		44.0	41.0						91
RU	30.0		45.0	41.0						77
RV	24.0		15.0	41.0						91
RW	24.0		19.0	41.0						91

Lead Taping & Packaging (IEC 60286-2)

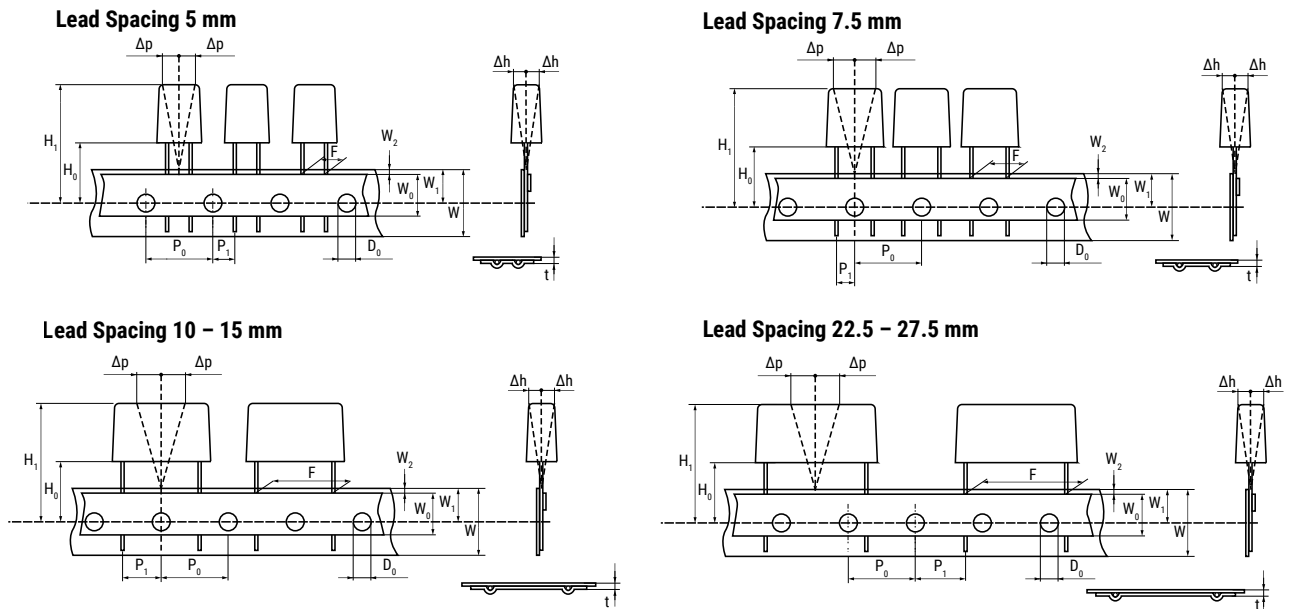

Taping Specification

Dimensions in mm									Standard IEC 60286-2
Lead Spacing	+0.6/-0.1	F	5	7.5	10	15	22.5	27.5	F
Carrier Tape Width	+1/-0.5	W	18	18	18	18	18	18	18 ^{+1/-0.5}
Hold-down Tape Width	Minimum	W_0	6	6	9	10	10	10	
Position of Sprocket Hole	± 0.5	W_1	9	9	9	9	9	9	9 ^{+0.75/-0.5}
Distance Between Tapes	Maximum	W_2	3	3	3	3	3	3	3
Sprocket Hole Diameter	± 0.2	D_0	4	4	4	4	4	4	4
Feed Hole Lead Spacing	± 0.2 ⁽¹⁾	P_0 ⁽³⁾	12.7	12.7	12.7	12.7	12.7	12.7	12.7
Distance Lead - Feed Hole	± 0.7	P_1	3.85	3.75	7.7	5.2	7.8	5.3	P ¹
Deviation Tape - Plane	Maximum	Δp	1.3	1.3	1.3	1.3	1.3	1.3	1.3
Lateral Deviation	± 2	Δh	2	2	2	2	2	2	2
Total Thickness	± 0.2	t	0.7	0.7	0.7	0.7	0.9 ^{MAX}	0.9 ^{MAX}	0.9 ^{MAX}
Sprocket Hole/Cap Body	± 0.5	H_0 ⁽²⁾	18.5 ± 0.5	18.5 ± 0.5	18.5 ± 0.5	18.5 ± 0.5	18.5 ± 0.5	18.5 ± 0.5	18 ^{+2/-0}

(1) Maximum cumulative feed hole error, 1 mm per 20 parts.

(2) 16.5 mm available on request.

(3) 15 mm available on request ($F \geq 10$ mm).

Lead Taping & Packaging (IEC 60286-2) cont.

Ammo Specifications

Series	Dimensions (mm)		
	H	W	T
R4x, R4x+R, R7x, RSB	360	340	59
F5A, F5B, F5D			
F6xx, F8xx			
PHExxx, PMExxx, PMRxxx	330	330	50



Reel Specifications

Series	Dimensions (mm)		
	D	H	W
R4x, R4x+R, R7x, RSB	355 500	30	55
F5A, F5B, F5D		25	(maximum)
F6xx, F8xx			
PHExxx, PMExxx, PMRxxx	360 500	30	46 (maximum)

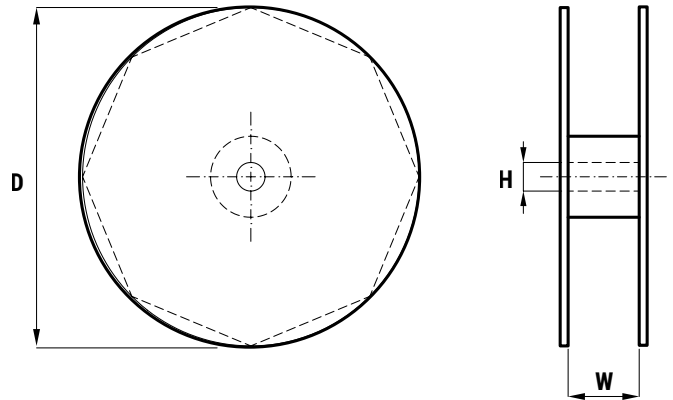

KEMET Electronics Corporation Sales Offices

For a complete list of our global sales offices, please visit www.kemet.com/sales.

Disclaimer

All product specifications, statements, information and data (collectively, the "Information") in this datasheet are subject to change. The customer is responsible for checking and verifying the extent to which the Information contained in this publication is applicable to an order at the time the order is placed. All Information given herein is believed to be accurate and reliable, but it is presented without guarantee, warranty, or responsibility of any kind, expressed or implied.

Statements of suitability for certain applications are based on KEMET Electronics Corporation's ("KEMET") knowledge of typical operating conditions for such applications, but are not intended to constitute – and KEMET specifically disclaims – any warranty concerning suitability for a specific customer application or use. The Information is intended for use only by customers who have the requisite experience and capability to determine the correct products for their application. Any technical advice inferred from this Information or otherwise provided by KEMET with reference to the use of KEMET's products is given gratis, and KEMET assumes no obligation or liability for the advice given or results obtained.

Although KEMET designs and manufactures its products to the most stringent quality and safety standards, given the current state of the art, isolated component failures may still occur. Accordingly, customer applications which require a high degree of reliability or safety should employ suitable designs or other safeguards (such as installation of protective circuitry or redundancies) in order to ensure that the failure of an electrical component does not result in a risk of personal injury or property damage.

Although all product-related warnings, cautions and notes must be observed, the customer should not assume that all safety measures are indicated or that other measures may not be required.

KEMET is a registered trademark of KEMET Electronics Corporation.

Компания «Океан Электроники» предлагает заключение долгосрочных отношений при поставках импортных электронных компонентов на взаимовыгодных условиях!

Наши преимущества:

- Поставка оригинальных импортных электронных компонентов напрямую с производств Америки, Европы и Азии, а так же с крупнейших складов мира;
- Широкая линейка поставок активных и пассивных импортных электронных компонентов (более 30 млн. наименований);
- Поставка сложных, дефицитных, либо снятых с производства позиций;
- Оперативные сроки поставки под заказ (от 5 рабочих дней);
- Экспресс доставка в любую точку России;
- Помощь Конструкторского Отдела и консультации квалифицированных инженеров;
- Техническая поддержка проекта, помощь в подборе аналогов, поставка прототипов;
- Поставка электронных компонентов под контролем ВП;
- Система менеджмента качества сертифицирована по Международному стандарту ISO 9001;
- При необходимости вся продукция военного и аэрокосмического назначения проходит испытания и сертификацию в лаборатории (по согласованию с заказчиком);
- Поставка специализированных компонентов военного и аэрокосмического уровня качества (Xilinx, Altera, Analog Devices, Intersil, Interpoint, Microsemi, Actel, Aeroflex, Peregrine, VPT, Syfer, Eurofarad, Texas Instruments, MS Kennedy, Miteq, Cobham, E2V, MA-COM, Hittite, Mini-Circuits, General Dynamics и др.);

Компания «Океан Электроники» является официальным дистрибьютором и эксклюзивным представителем в России одного из крупнейших производителей разъемов военного и аэрокосмического назначения «JONHON», а так же официальным дистрибьютором и эксклюзивным представителем в России производителя высокотехнологичных и надежных решений для передачи СВЧ сигналов «FORSTAR».



JONHON

«JONHON» (основан в 1970 г.)

Разъемы специального, военного и аэрокосмического назначения:

(Применяются в военной, авиационной, аэрокосмической, морской, железнодорожной, горно- и нефтедобывающей отраслях промышленности)

«FORSTAR» (основан в 1998 г.)

ВЧ соединители, коаксиальные кабели, кабельные сборки и микроволновые компоненты:

(Применяются в телекоммуникациях гражданского и специального назначения, в средствах связи, РЛС, а так же военной, авиационной и аэрокосмической отраслях промышленности).



Телефон: 8 (812) 309-75-97 (многоканальный)

Факс: 8 (812) 320-03-32

Электронная почта: ocean@oceanchips.ru

Web: <http://oceanchips.ru/>

Адрес: 198099, г. Санкт-Петербург, ул. Калинина, д. 2, корп. 4, лит. А