

D Series Power MOSFET

| PRODUCT SUMMARY | | |
|---|-----------------|------|
| V_{DS} (V) at T_J max. | 450 | |
| $R_{DS(on)}$ max. at 25 °C (Ω) | $V_{GS} = 10$ V | 0.17 |
| Q_g max. (nC) | 88 | |
| Q_{gs} (nC) | 12 | |
| Q_{gd} (nC) | 23 | |
| Configuration | Single | |

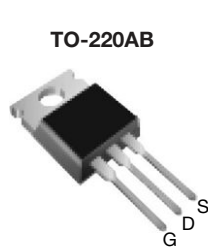

FEATURES

- Optimal Design
 - Low Area Specific On-Resistance
 - Low Input Capacitance (C_{iss})
 - Reduced Capacitive Switching Losses
 - High Body Diode Ruggedness
 - Avalanche Energy Rated (UIS)
- Optimal Efficiency and Operation
 - Low Cost
 - Simple Gate Drive Circuitry
 - Low Figure-of-Merit (FOM): $R_{on} \times Q_g$
 - Fast Switching
- Compliant to RoHS Directive 2011/65/EU

Note

* Pb containing terminations are not RoHS compliant, exemptions may apply

APPLICATIONS

- Consumer Electronics
 - Displays (LCD or Plasma TV)
- Lighting
- Industrial
 - Welding
 - Induction Heating
 - Motor Drives
 - Battery Chargers
- SMPS



RoHS*
COMPLIANT
HALOGEN
FREE
Available

| ORDERING INFORMATION | |
|---------------------------------|----------------|
| Package | TO-220AB |
| Lead (Pb)-free | SiHP25N40D-E3 |
| Lead (Pb)-free and Halogen-free | SiHP25N40D-GE3 |

| ABSOLUTE MAXIMUM RATINGS ($T_C = 25$ °C, unless otherwise noted) | | | |
|---|------------------|----------------|------|
| PARAMETER | SYMBOL | LIMIT | UNIT |
| Drain-Source Voltage | V_{DS} | 400 | V |
| Gate-Source Voltage | V_{GS} | ± 30 | |
| Gate-Source Voltage AC ($f > 1$ Hz) | | 30 | |
| Continuous Drain Current ($T_J = 150$ °C) | V_{GS} at 10 V | $T_C = 25$ °C | A |
| | | $T_C = 100$ °C | |
| Pulsed Drain Current ^a | I_{DM} | 78 | |
| Linear Derating Factor | | 2.2 | W/°C |
| Single Pulse Avalanche Energy ^b | E_{AS} | 556 | mJ |
| Maximum Power Dissipation | P_D | 278 | W |
| Operating Junction and Storage Temperature Range | T_J, T_{stg} | - 55 to + 150 | °C |
| Drain-Source Voltage Slope | dV/dt | $T_J = 125$ °C | V/ns |
| Reverse Diode dV/dt^d | | 0.6 | |
| Soldering Recommendations (Peak Temperature) | for 10 s | 300° | °C |

Notes

- Repetitive rating; pulse width limited by maximum junction temperature.
- $V_{DD} = 50$ V, starting $T_J = 25$ °C, $L = 2.3$ mH, $R_g = 25$ Ω , $I_{AS} = 17$ A.
- 1.6 mm from case.
- $I_{SD} \leq I_D$, starting $T_J = 25$ °C.



| THERMAL RESISTANCE RATINGS | | | | |
|-----------------------------------|------------|------|------|------|
| PARAMETER | SYMBOL | TYP. | MAX. | UNIT |
| Maximum Junction-to-Ambient | R_{thJA} | - | 62 | °C/W |
| Maximum Junction-to-Case (Drain) | R_{thJC} | - | 0.45 | |

| SPECIFICATIONS ($T_J = 25\text{ °C}$, unless otherwise noted) | | | | | | | |
|--|---------------------|---|--|------|------|-----------|---------------|
| PARAMETER | SYMBOL | TEST CONDITIONS | | MIN. | TYP. | MAX. | UNIT |
| Static | | | | | | | |
| Drain-Source Breakdown Voltage | V_{DS} | $V_{GS} = 0\text{ V}, I_D = 250\text{ }\mu\text{A}$ | | 400 | - | - | V |
| V_{DS} Temperature Coefficient | $\Delta V_{DS}/T_J$ | Reference to $25\text{ °C}, I_D = 250\text{ }\mu\text{A}$ | | - | 0.5 | - | V/°C |
| Gate-Source Threshold Voltage (N) | $V_{GS(th)}$ | $V_{DS} = V_{GS}, I_D = 250\text{ }\mu\text{A}$ | | 3 | - | 5 | V |
| Gate-Source Leakage | I_{GSS} | $V_{GS} = \pm 30\text{ V}$ | | - | - | ± 100 | nA |
| Zero Gate Voltage Drain Current | I_{DSS} | $V_{DS} = 400\text{ V}, V_{GS} = 0\text{ V}$ | | - | - | 1 | μA |
| | | $V_{DS} = 320\text{ V}, V_{GS} = 0\text{ V}, T_J = 125\text{ °C}$ | | - | - | 10 | |
| Drain-Source On-State Resistance | $R_{DS(on)}$ | $V_{GS} = 10\text{ V}$ | $I_D = 13\text{ A}$ | - | 0.14 | 0.17 | Ω |
| Forward Transconductance | g_{fs} | $V_{DS} = 50\text{ V}, I_D = 13\text{ A}$ | | - | 7.4 | - | S |
| Dynamic | | | | | | | |
| Input Capacitance | C_{iss} | $V_{GS} = 0\text{ V}, V_{DS} = 100\text{ V}, f = 1\text{ MHz}$ | | - | 1707 | - | μF |
| Output Capacitance | C_{oss} | | | - | 177 | - | |
| Reverse Transfer Capacitance | C_{rss} | | | - | 19 | - | |
| Total Gate Charge | Q_g | $V_{GS} = 10\text{ V}$ | $I_D = 13\text{ A}, V_{DS} = 320\text{ V}$ | - | 44 | 88 | nC |
| Gate-Source Charge | Q_{gs} | | | - | 12 | - | |
| Gate-Drain Charge | Q_{gd} | | | - | 23 | - | |
| Turn-On Delay Time | $t_{d(on)}$ | $V_{DD} = 320\text{ V}, I_D = 13\text{ A}, V_{GS} = 10\text{ V}, R_g = 24.6\text{ }\Omega$ | | - | 21 | 42 | ns |
| Rise Time | t_r | | | - | 57 | 86 | |
| Turn-Off Delay Time | $t_{d(off)}$ | | | - | 40 | 80 | |
| Fall Time | t_f | | | - | 37 | 74 | |
| Gate Input Resistance | R_g | $f = 1\text{ MHz}, \text{open drain}$ | | - | 1.8 | - | Ω |
| Drain-Source Body Diode Characteristics | | | | | | | |
| Continuous Source-Drain Diode Current | I_S | MOSFET symbol showing the integral reverse p - n junction diode  | | - | - | 24 | A |
| Pulsed Diode Forward Current | I_{SM} | | | - | - | 78 | |
| Diode Forward Voltage | V_{SD} | $T_J = 25\text{ °C}, I_S = 13\text{ A}, V_{GS} = 0\text{ V}$ | | - | - | 1.2 | V |
| Reverse Recovery Time | t_{rr} | $T_J = 25\text{ °C}, I_F = I_S = 13\text{ A}, di/dt = 100\text{ A}/\mu\text{s}, V_R = 20\text{ V}$ | | - | 353 | - | ns |
| Reverse Recovery Charge | Q_{rr} | | | - | 4.4 | - | μC |
| Reverse Recovery Current | I_{RRM} | | | - | 24 | - | A |

TYPICAL CHARACTERISTICS (25 °C, unless otherwise noted)

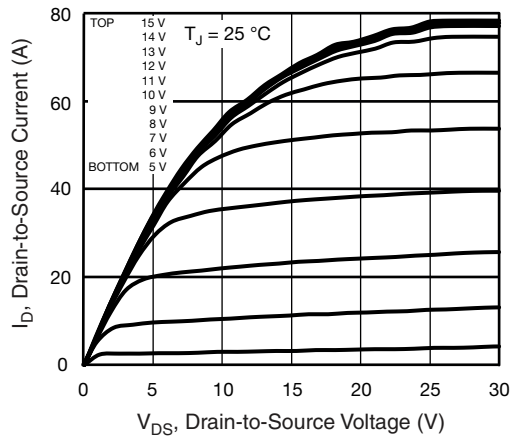

Fig. 1 - Typical Output Characteristics

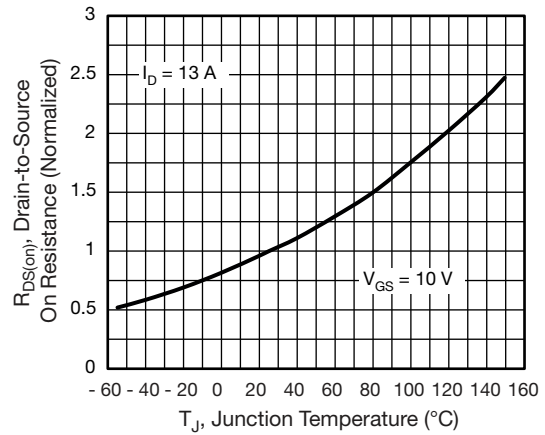

Fig. 4 - Normalized On-Resistance vs. Temperature

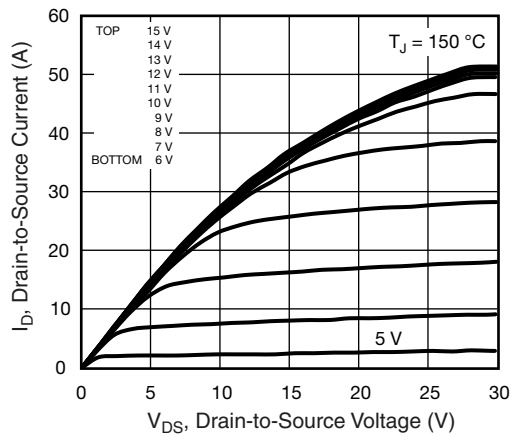

Fig. 2 - Typical Output Characteristics

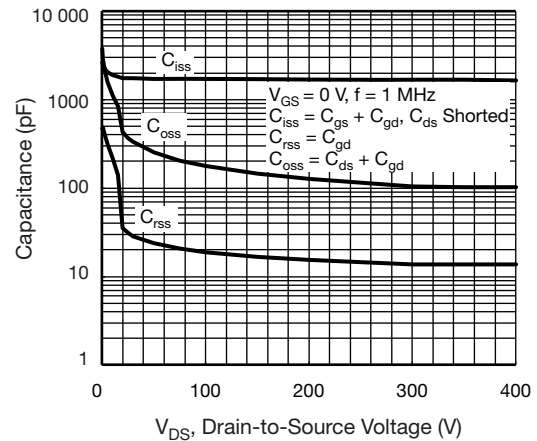

Fig. 5 - Typical Capacitance vs. Drain-to-Source Voltage

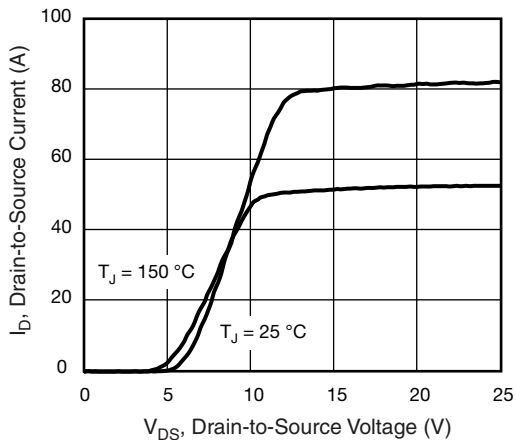

Fig. 3 - Typical Transfer Characteristics

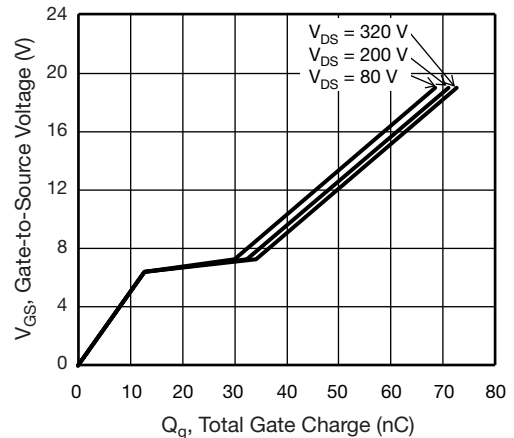

Fig. 6 - Typical Gate Charge vs. Gate-to-Source Voltage

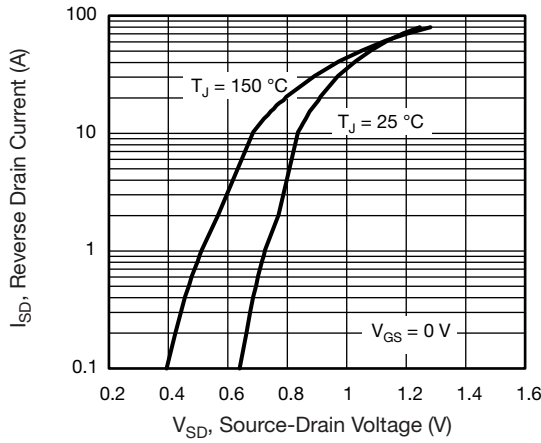

Fig. 7 - Typical Source-Drain Diode Forward Voltage

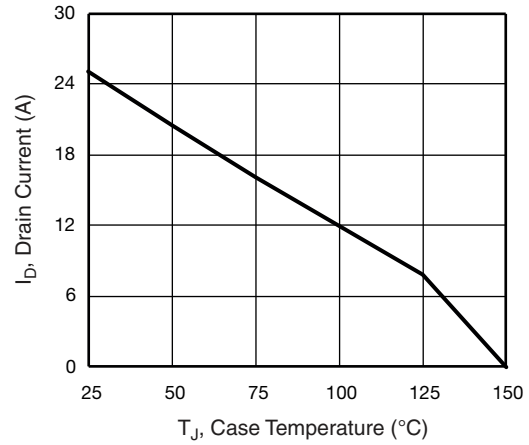

Fig. 9 - Maximum Drain Current vs. Case Temperature



Fig. 8 - Maximum Safe Operating Area

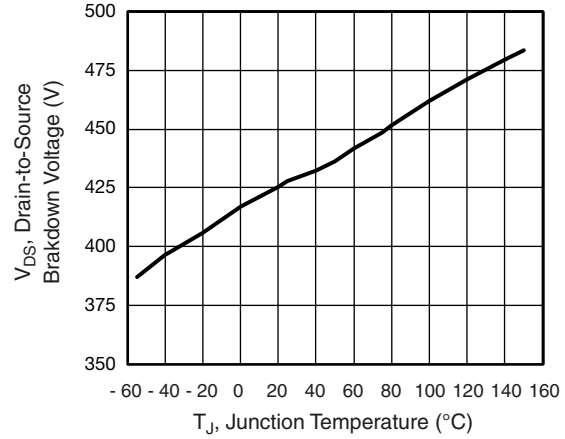

Fig. 10 - Temperature vs. Drain-to-Source Voltage

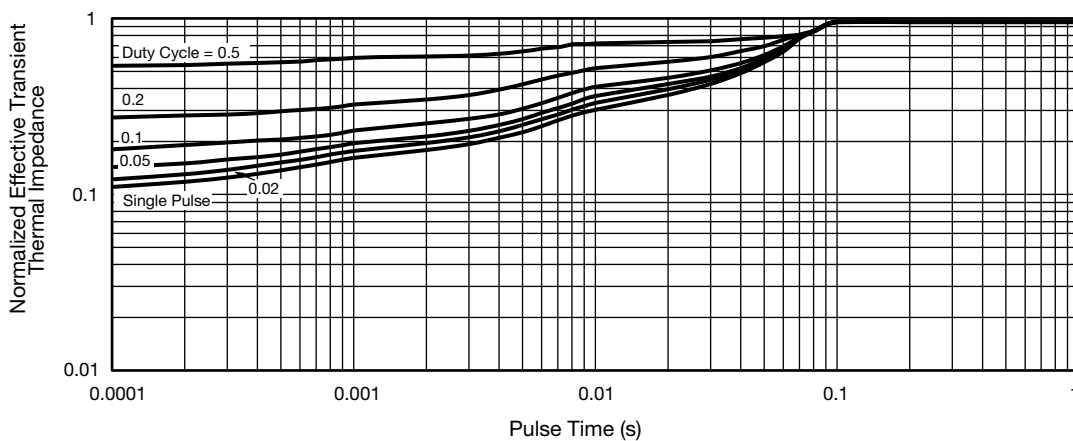

Fig. 11 - Normalized Thermal Transient Impedance, Junction-to-Case



Fig. 12 - Switching Time Test Circuit



Fig. 16 - Basic Gate Charge Waveform



Fig. 13 - Switching Time Waveforms

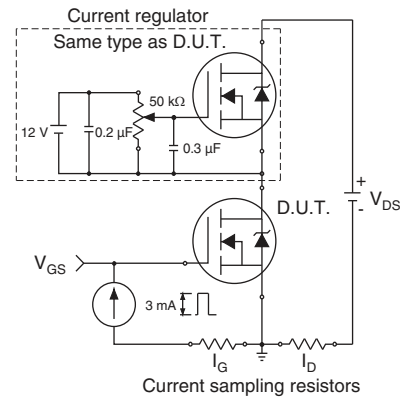

Fig. 17 - Gate Charge Test Circuit

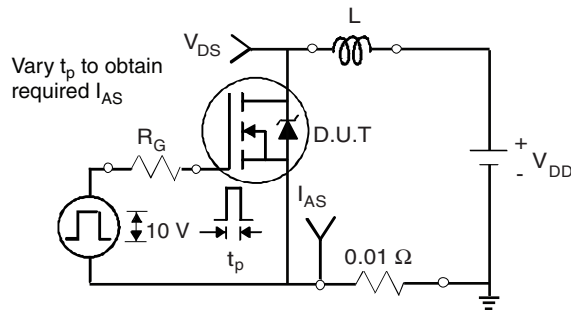

Fig. 14 - Unclamped Inductive Test Circuit



Fig. 15 - Unclamped Inductive Waveforms

Peak Diode Recovery dV/dt Test Circuit



Note

a. $V_{GS} = 5 V$ for logic level devices

Fig. 18 - For N-Channel

Vishay Siliconix maintains worldwide manufacturing capability. Products may be manufactured at one of several qualified locations. Reliability data for Silicon Technology and Package Reliability represent a composite of all qualified locations. For related documents such as package/tape drawings, part marking, and reliability data, see www.vishay.com/ppg?91483.



TO-220AB



| DIM. | MILLIMETERS | | INCHES | |
|------|-------------|-------|--------|-------|
| | MIN. | MAX. | MIN. | MAX. |
| A | 4.25 | 4.65 | 0.167 | 0.183 |
| b | 0.69 | 1.01 | 0.027 | 0.040 |
| b(1) | 1.20 | 1.73 | 0.047 | 0.068 |
| c | 0.36 | 0.61 | 0.014 | 0.024 |
| D | 14.85 | 15.49 | 0.585 | 0.610 |
| E | 10.04 | 10.51 | 0.395 | 0.414 |
| e | 2.41 | 2.67 | 0.095 | 0.105 |
| e(1) | 4.88 | 5.28 | 0.192 | 0.208 |
| F | 1.14 | 1.40 | 0.045 | 0.055 |
| H(1) | 6.09 | 6.48 | 0.240 | 0.255 |
| J(1) | 2.41 | 2.92 | 0.095 | 0.115 |
| L | 13.35 | 14.02 | 0.526 | 0.552 |
| L(1) | 3.32 | 3.82 | 0.131 | 0.150 |
| Ø P | 3.54 | 3.94 | 0.139 | 0.155 |
| Q | 2.60 | 3.00 | 0.102 | 0.118 |

ECN: X12-0208-Rev. N, 08-Oct-12
DWG: 5471

Notes

- * M = 1.32 mm to 1.62 mm (dimension including protrusion)
Heatsink hole for HVM
- Xi'an and Mingxin actual photo

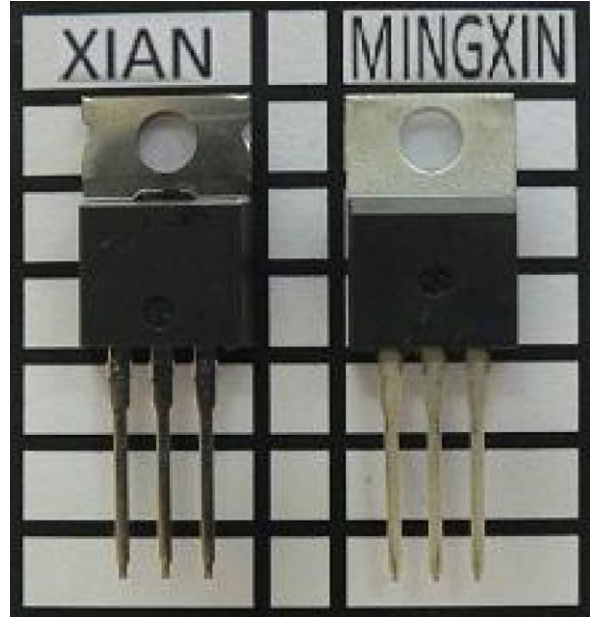



Disclaimer

ALL PRODUCT, PRODUCT SPECIFICATIONS AND DATA ARE SUBJECT TO CHANGE WITHOUT NOTICE TO IMPROVE RELIABILITY, FUNCTION OR DESIGN OR OTHERWISE.

Vishay Intertechnology, Inc., its affiliates, agents, and employees, and all persons acting on its or their behalf (collectively, "Vishay"), disclaim any and all liability for any errors, inaccuracies or incompleteness contained in any datasheet or in any other disclosure relating to any product.

Vishay makes no warranty, representation or guarantee regarding the suitability of the products for any particular purpose or the continuing production of any product. To the maximum extent permitted by applicable law, Vishay disclaims (i) any and all liability arising out of the application or use of any product, (ii) any and all liability, including without limitation special, consequential or incidental damages, and (iii) any and all implied warranties, including warranties of fitness for particular purpose, non-infringement and merchantability.

Statements regarding the suitability of products for certain types of applications are based on Vishay's knowledge of typical requirements that are often placed on Vishay products in generic applications. Such statements are not binding statements about the suitability of products for a particular application. It is the customer's responsibility to validate that a particular product with the properties described in the product specification is suitable for use in a particular application. Parameters provided in datasheets and/or specifications may vary in different applications and performance may vary over time. All operating parameters, including typical parameters, must be validated for each customer application by the customer's technical experts. Product specifications do not expand or otherwise modify Vishay's terms and conditions of purchase, including but not limited to the warranty expressed therein.

Except as expressly indicated in writing, Vishay products are not designed for use in medical, life-saving, or life-sustaining applications or for any other application in which the failure of the Vishay product could result in personal injury or death. Customers using or selling Vishay products not expressly indicated for use in such applications do so at their own risk. Please contact authorized Vishay personnel to obtain written terms and conditions regarding products designed for such applications.

No license, express or implied, by estoppel or otherwise, to any intellectual property rights is granted by this document or by any conduct of Vishay. Product names and markings noted herein may be trademarks of their respective owners.

Material Category Policy

Vishay Intertechnology, Inc. hereby certifies that all its products that are identified as RoHS-Compliant fulfill the definitions and restrictions defined under Directive 2011/65/EU of The European Parliament and of the Council of June 8, 2011 on the restriction of the use of certain hazardous substances in electrical and electronic equipment (EEE) - recast, unless otherwise specified as non-compliant.

Please note that some Vishay documentation may still make reference to RoHS Directive 2002/95/EC. We confirm that all the products identified as being compliant to Directive 2002/95/EC conform to Directive 2011/65/EU.

Vishay Intertechnology, Inc. hereby certifies that all its products that are identified as Halogen-Free follow Halogen-Free requirements as per JEDEC JS709A standards. Please note that some Vishay documentation may still make reference to the IEC 61249-2-21 definition. We confirm that all the products identified as being compliant to IEC 61249-2-21 conform to JEDEC JS709A standards.

Компания «Океан Электроники» предлагает заключение долгосрочных отношений при поставках импортных электронных компонентов на взаимовыгодных условиях!

Наши преимущества:

- Поставка оригинальных импортных электронных компонентов напрямую с производств Америки, Европы и Азии, а так же с крупнейших складов мира;
- Широкая линейка поставок активных и пассивных импортных электронных компонентов (более 30 млн. наименований);
- Поставка сложных, дефицитных, либо снятых с производства позиций;
- Оперативные сроки поставки под заказ (от 5 рабочих дней);
- Экспресс доставка в любую точку России;
- Помощь Конструкторского Отдела и консультации квалифицированных инженеров;
- Техническая поддержка проекта, помощь в подборе аналогов, поставка прототипов;
- Поставка электронных компонентов под контролем ВП;
- Система менеджмента качества сертифицирована по Международному стандарту ISO 9001;
- При необходимости вся продукция военного и аэрокосмического назначения проходит испытания и сертификацию в лаборатории (по согласованию с заказчиком);
- Поставка специализированных компонентов военного и аэрокосмического уровня качества (Xilinx, Altera, Analog Devices, Intersil, Interpoint, Microsemi, Actel, Aeroflex, Peregrine, VPT, Syfer, Eurofarad, Texas Instruments, MS Kennedy, Miteq, Cobham, E2V, MA-COM, Hittite, Mini-Circuits, General Dynamics и др.);

Компания «Океан Электроники» является официальным дистрибьютором и эксклюзивным представителем в России одного из крупнейших производителей разъемов военного и аэрокосмического назначения «JONHON», а так же официальным дистрибьютором и эксклюзивным представителем в России производителя высокотехнологичных и надежных решений для передачи СВЧ сигналов «FORSTAR».



JONHON

«JONHON» (основан в 1970 г.)

Разъемы специального, военного и аэрокосмического назначения:

(Применяются в военной, авиационной, аэрокосмической, морской, железнодорожной, горно- и нефтедобывающей отраслях промышленности)

«FORSTAR» (основан в 1998 г.)

ВЧ соединители, коаксиальные кабели, кабельные сборки и микроволновые компоненты:

(Применяются в телекоммуникациях гражданского и специального назначения, в средствах связи, РЛС, а так же военной, авиационной и аэрокосмической отраслях промышленности).



Телефон: 8 (812) 309-75-97 (многоканальный)

Факс: 8 (812) 320-03-32

Электронная почта: ocean@oceanchips.ru

Web: <http://oceanchips.ru/>

Адрес: 198099, г. Санкт-Петербург, ул. Калинина, д. 2, корп. 4, лит. А