

Z0103MN, Z0107MN, Z0109MN

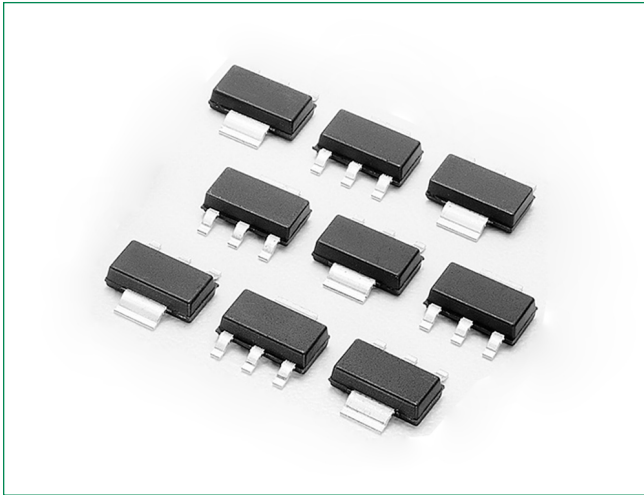

**Description**

Designed for use in solid state relays, MPU interface, TTL logic and other light industrial or consumer applications. Supplied in surface mount package for use in automated manufacturing.

**Features**

- Sensitive Gate Trigger Current in Four Trigger Modes
- Blocking Voltage to 600 V
- Glass Passivated Surface for Reliability and Uniformity
- Surface Mount Package
- These are Pb-Free Devices

**Pin Out**

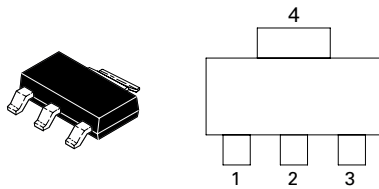

**Functional Diagram**

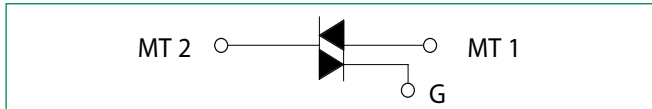

**Additional Information**



Datasheet



Resources



Samples

### Maximum Ratings ( $T_J = 25^\circ\text{C}$ unless otherwise noted)

Rating	Symbol	Value	Unit
Peak Repetitive Off-State Voltage (Note 1) ( $R_{GK} = I_K, T_J = -40$ to $+125^\circ\text{C}$ , Sine Wave, 50 to 60 Hz)	$V_{DRM}^*$ $V_{RRM}$	600	V
On-State RMS Current (Full Sine Wave 50 to 60 Hz; $T_C = 80^\circ\text{C}$ )	$I_T (RMS)$	1.0	A
Peak Non-repetitive Surge Current (One Full Cycle Sine Wave, 60 Hz, $T_C = 25^\circ\text{C}$ )	$I_T (RMS)$	8.0	A
Circuit Fusing Considerations ( $t = 8.3$ ms)	$I^2t$	0.4	A <sup>2</sup> s
Average Gate Power ( $T_C = 80^\circ\text{C}$ , $t \leq 8.3$ ms)	$P_{G(AV)}$	1.0	W
Peak Gate Current ( $t \leq 20$ s, $T_J = +125^\circ\text{C}$ )	$I_{GM}$	1.0	A
Operating Junction Temperature Range @ Rated $V_{RRM}$ and $V_{DRM}$	$T_J$	-40 to +110	$^\circ\text{C}$
Storage Temperature Range	$T_{stg}$	-40 to +150	$^\circ\text{C}$

### Thermal Characteristics

Rating	Symbol	Value	Unit
Thermal Resistance, Junction-to-Ambient PCB Mounted per Figure 1	$R_{\theta JA}$	156	$^\circ\text{C}/\text{W}$
Thermal Resistance, Junction-to-Tab Measured on MT2 Tab Adjacent to Epoxy	$R_{\theta JT}$	25	$^\circ\text{C}/\text{W}$
Maximum Device Temperature for Soldering Purposes for 10 Secs Maximum	$T_L$	260	$^\circ\text{C}$

Stresses exceeding Maximum Ratings may damage the device. Maximum Ratings are stress ratings only. Functional operation above the Recommended Operating Conditions is not implied. Extended exposure to stresses above the Recommended Operating Conditions may affect device reliability.

- $V_{DRM}$  and  $V_{RRM}$  for all types can be applied on a continuous basis. Ratings apply for zero or negative gate voltage; however, positive gate voltage shall not be applied concurrent with negative potential on the anode. Blocking voltages shall not be tested with a constant current source such that the voltage ratings of the devices are exceeded.

### Electrical Characteristics - OFF ( $T_J = 25^\circ\text{C}$ unless otherwise noted)

Characteristic		Symbol	Min	Typ	Max	Unit
Peak Repetitive Forward or Reverse Blocking Current (Note 3) ( $V_{AK} = \text{Rated } V_{DRM} \text{ or } V_{RRM}, R_{GK} = 1000 \text{ k}\Omega$ )	$T_J = 25^\circ\text{C}$	$I_{DRM}^*$	-	-	5.0	$\mu\text{A}$
	$T_J = 125^\circ\text{C}$		-	-	500	

### Electrical Characteristics - ON ( $T_J = 25^\circ\text{C}$ unless otherwise noted; Electricals apply in both directions)

Characteristic		Symbol	Min	Typ	Max	Unit
Peak On-State Voltage ( $I_{TM} = \pm 11$ A Peak, Pulse Width $\leq 2$ ms, Duty Cycle $\leq 2\%$ )		$V_{TM}$	–	–	1.8	V
Z0103MN Gate Trigger Current (Continuous dc) ( $V_D = 12$ V, $R_L = 30$ Ohms)	MT2(+), G(+)	$I_{GT}$	0.15	–	3.0	mA
	MT2(+), G(–)		0.15	–	3.0	
	MT2(–), G(–)		0.15	–	3.0	
	MT2(–), G(+)		0.25	–	5.0	
Z0107MN Gate Trigger Current (Continuous dc) ( $V_D = 12$ V, $R_L = 30$ Ohms)	MT2(+), G(+)	$I_{GT}$	0.15	–	5.0	mA
	MT2(+), G(–)		0.15	–	5.0	
	MT2(–), G(–)		0.15	–	5.0	
	MT2(–), G(+)		0.25	–	7.0	
Z0109MN Gate Trigger Current (Continuous dc) ( $V_D = 12$ V, $R_L = 30$ Ohms)	MT2(+), G(+)	$I_{GT}$	0.15	–	10	mA
	MT2(+), G(–)		0.15	–	10	
	MT2(–), G(–)		0.15	–	10	
	MT2(–), G(+)		0.25	–	10	
Z0103MN Latching Current ( $V_D = 12$ V, $I_G = 1.2 \times I_{GT}$ ) ALL TYPES	MT2(+), G(+)	$I_L$	–	–	7.0	mA
	MT2(+), G(–)		–	–	15	
	MT2(–), G(–)		–	–	7.0	
	MT2(–), G(+)		–	–	7.0	
Z0107MN Latching Current ( $V_D = 12$ V, $I_G = 1.2 \times I_{GT}$ ) ALL TYPES	MT2(+), G(+)	$I_L$	–	–	10	mA
	MT2(+), G(–)		–	–	20	
	MT2(–), G(–)		–	–	10	
	MT2(–), G(+)		–	–	10	
Z0109MN Latching Current ( $V_D = 12$ V, $I_G = 1.2 \times I_{GT}$ ) ALL TYPES	MT2(+), G(+)	$I_L$	–	–	15	mA
	MT2(+), G(–)		–	–	25	
	MT2(–), G(–)		–	–	15	
	MT2(–), G(+)		–	–	15	

### Electrical Characteristics - ON ( $T_J = 25^\circ\text{C}$ unless otherwise noted; Electricals apply in both directions) Continued

Gate Trigger Voltage (Continuous dc) ( $V_D = 12$ Vdc, $R_L = 30$ Ohms)	$V_{GT}$	–	–	1.3	V
Gate-Controlled Turn-On Time, ( $V_D = \text{Rated } V_{DRM}$ , $I_{TM} = 16$ A Peak, $I_G = 30$ mA)	$t_{gt}$	0.2	–	10	$\mu\text{s}$

**Dynamic Characteristics**

Characteristic	Symbol	Min	Typ	Max	Unit
Rate of Change of Commutating Current ( $V_D = 400\text{ V}$ , $I_{TM} = 0.84\text{ A}$ , Commutating $dv/dt = 1.5\text{ V}/\mu\text{s}$ , Gate Open, $T_J = 110^\circ\text{C}$ , $f = 250\text{ Hz}$ , with Snubber)	$dv/dt$	1.6	-	-	A/ms
Critical Rate of Rise of On-State Current ( $T_C = 110^\circ\text{C}$ , $I_G = 2 \times I_{GT}$ , $R_{GK} = 1\text{ k}\Omega$ )	Z0103MN	10	30	-	V/ $\mu\text{s}$
	Z0107MN	20	60	-	
	Z0109MN	50	75	-	
Repetitive Critical Rate of Rise of On-State Current, $T_J = 125^\circ\text{C}$ Pulse Width = 20 $\mu\text{s}$ , $IPK_{max} = 15\text{ A}$ , $di/dt = 1\text{ A}/\mu\text{s}$ , $f = 60\text{ Hz}$		-	-	20	A/ $\mu\text{s}$

**Voltage Current Characteristic of SCR**

Symbol	Parameter
$V_{DRM}$	Peak Repetitive Forward Off State Voltage
$I_{DRM}$	Peak Forward Blocking Current
$V_{RRM}$	Peak Repetitive Reverse Off State Voltage
$I_{RRM}$	Peak Reverse Blocking Current
$V_{TM}$	Maximum On State Voltage
$I_H$	Holding Current

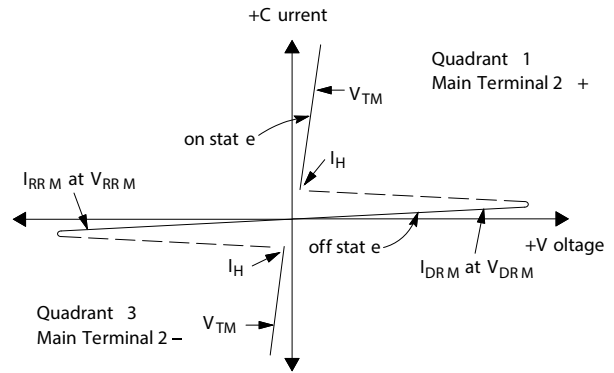

**Quadrant Definitions for a Triac**

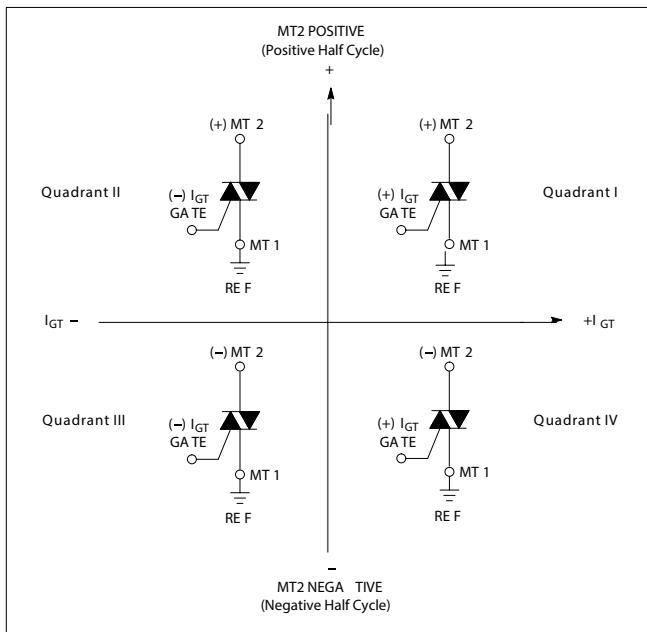

All polarities are referenced to MT1.  
With in-phase signals (using standard AC lines) quadrants I and III are used

**Figure 1. PCB for Thermal Impedance and Power Testing of SOT-223**

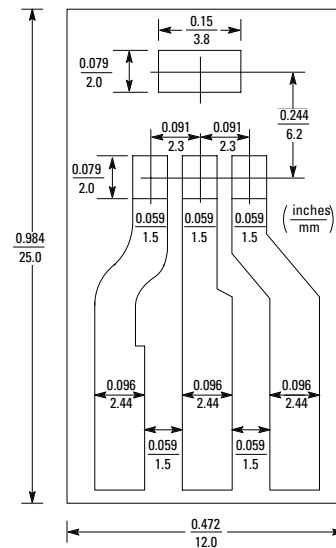

BOARD MOUNTED VERTICALLY IN CINCH 8840 EDGE CONNECTOR,  
BOARD THICKNESS = 65 MIL., FOIL THICKNESS = 2.5 MIL.  
MATERIAL: G10 FIBERGLASS BASE EPOXY

**Figure 2. On-State Characteristics**

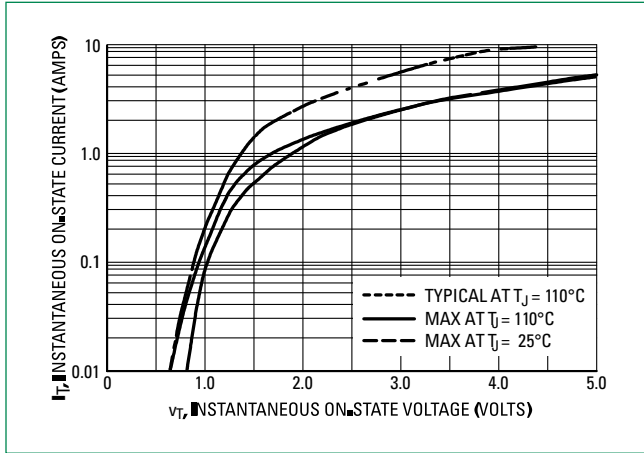

**Figure 3. Junction to Ambient Thermal Resistance vs Copper Tab Area**

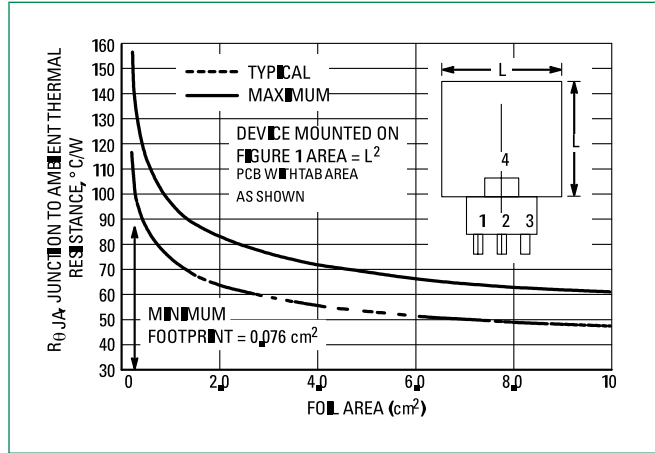

**Figure 4. Current Derating, Minimum Pad Size Reference: Ambient Temperature**

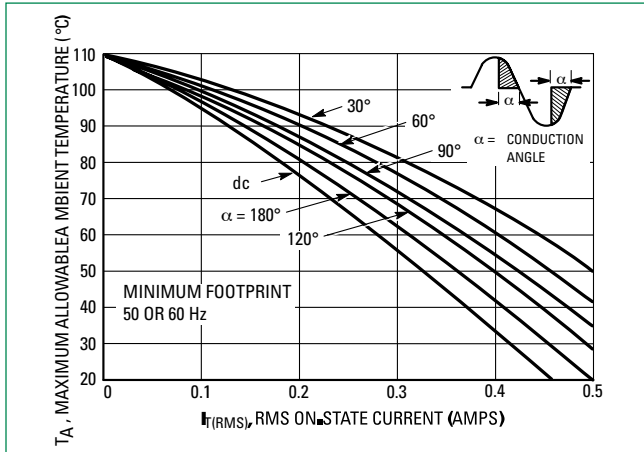

**Figure 5. Current Derating, 1.0 cm Square Pad Reference: Ambient Temperature**

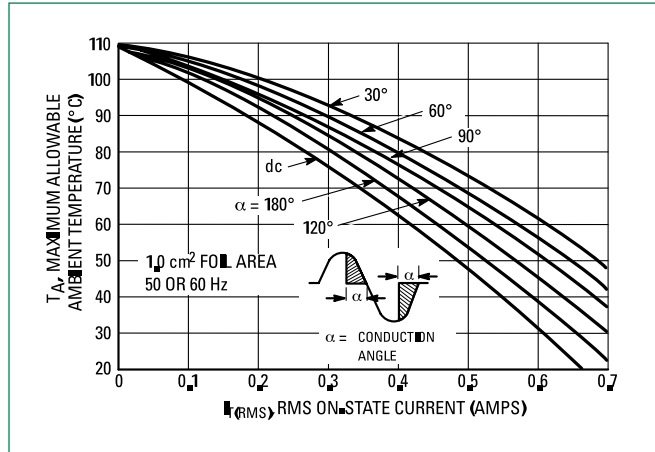

**Figure 6. Current Derating, 2.0 cm Square Pad Reference: Ambient Temperature**

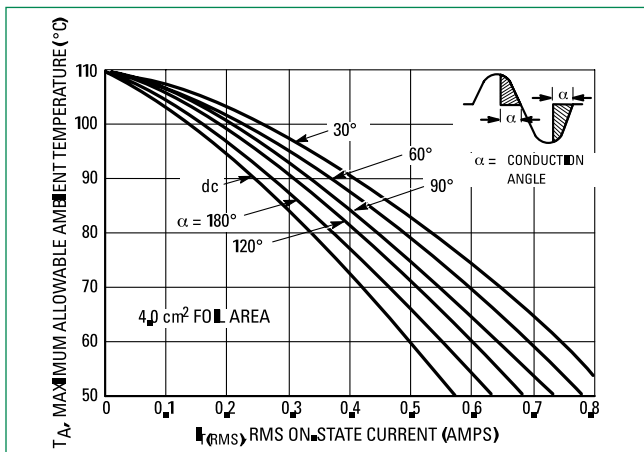

**Figure 7. Current Derating Reference: MT2 Tab**

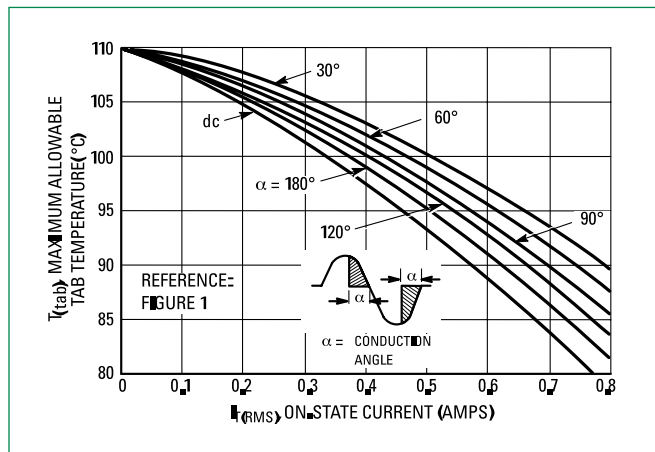

**Figure 8. Power Dissipation**

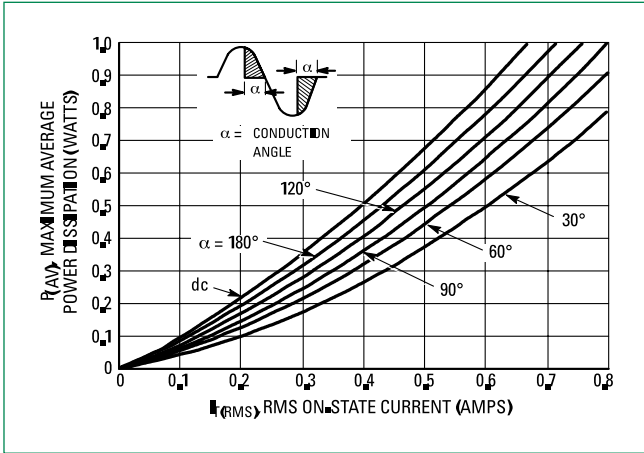

**Figure 9. Thermal Response, Device Mounted on Figure 1 Printed Circuit Board**

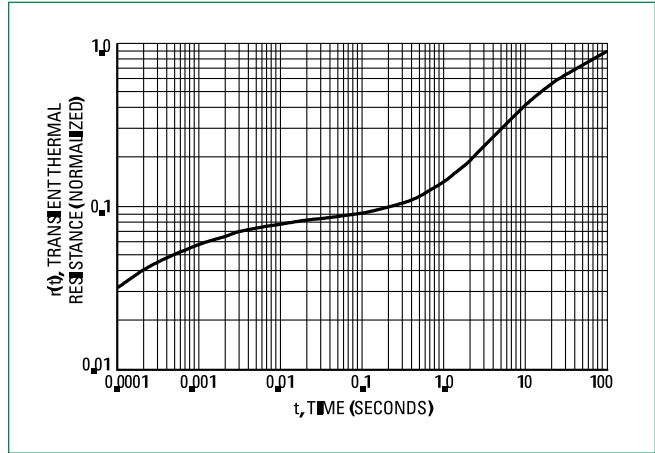

**Figure 10. Simplified Test Circuit to Measure the Critical Rate of Rise of Commutating Voltage (dv/dt)<sub>c</sub>**

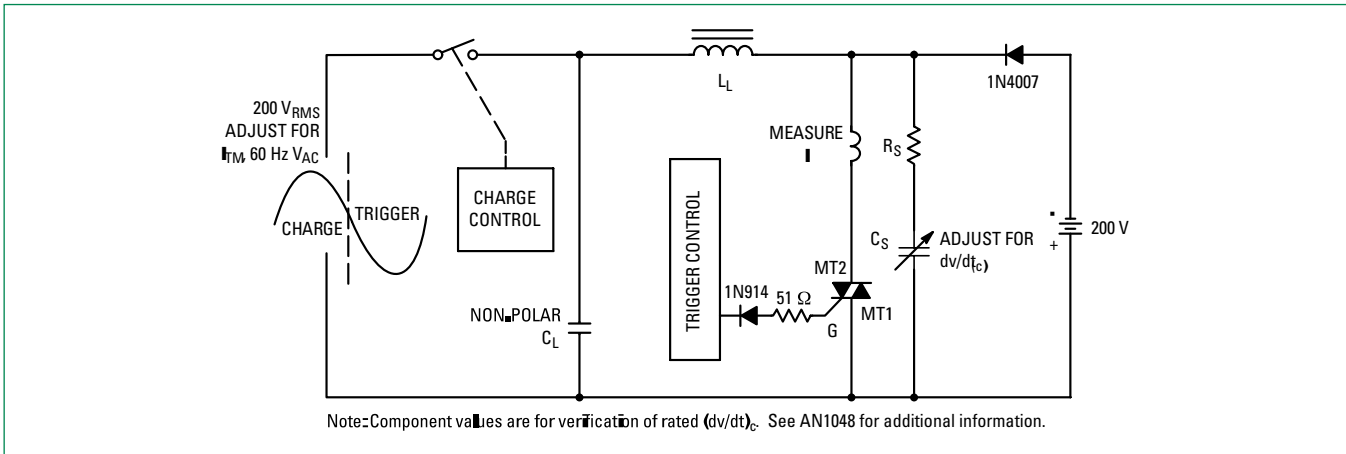

**Figure 11. Typical Commutating dv/dt vs Current Crossing Rate and Junction Temperature**

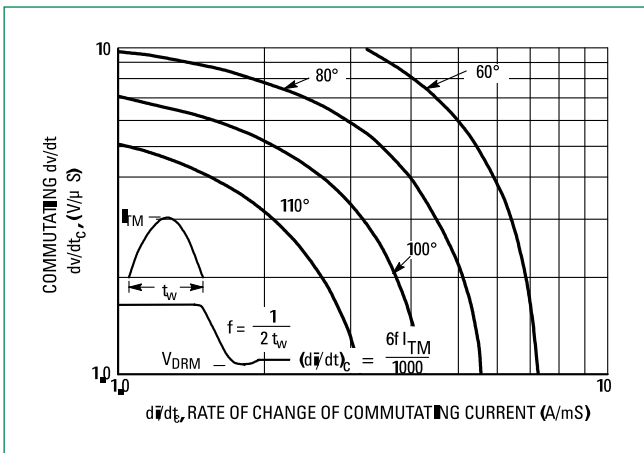

**Figure 12. Typical Commutating dv/dt vs Junction Temperature at 0.8 Amps RMS**

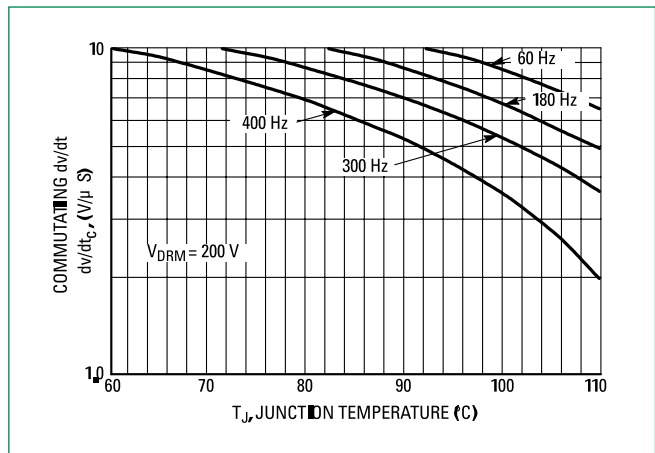

**Figure 13. Exponential Static dv/dt versus Gate – Main Terminal 1 Resistance**

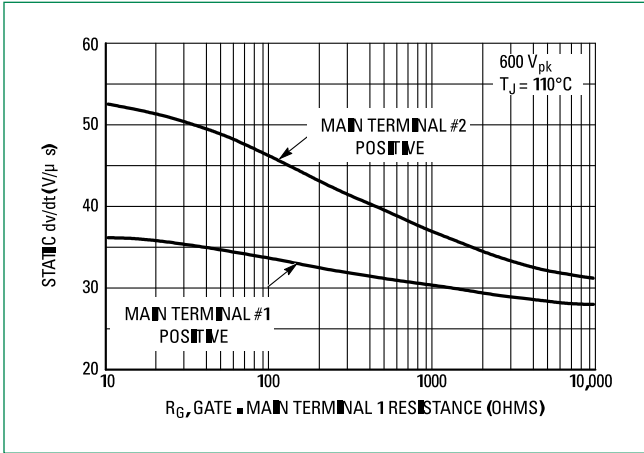

**Figure 14. Typical Gate Trigger Current Variation**

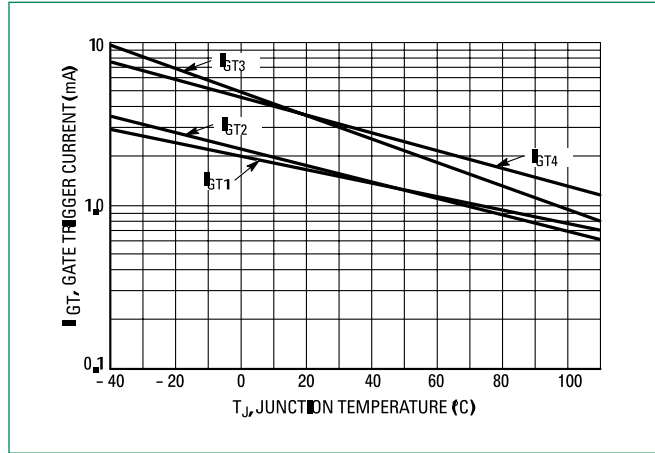

**Figure 15. Typical Holding Current Variation**

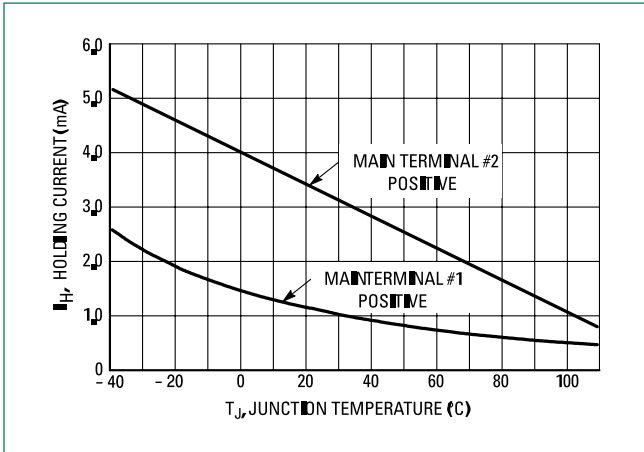

**Figure 16. Gate Trigger Voltage Variation**

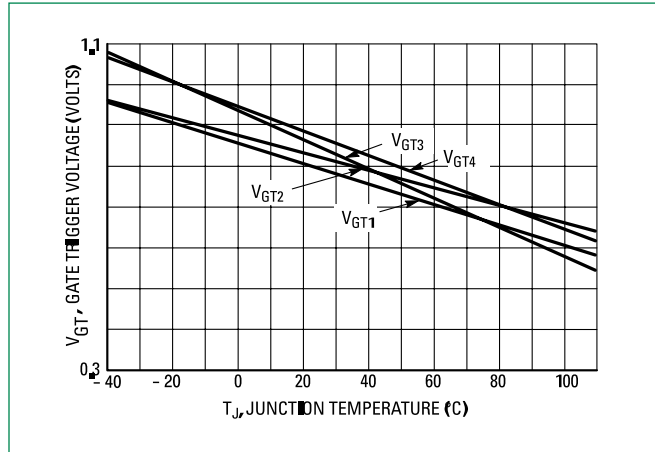

## Dimensions

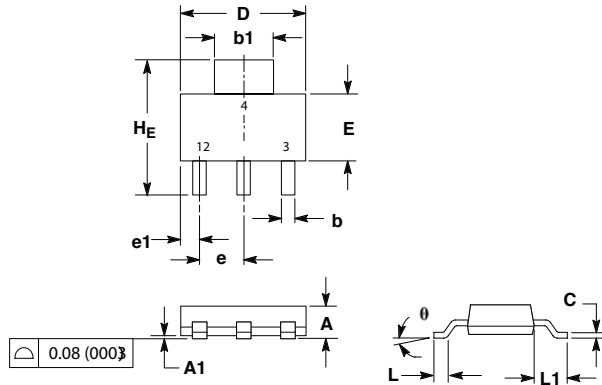

## Soldering Footprint

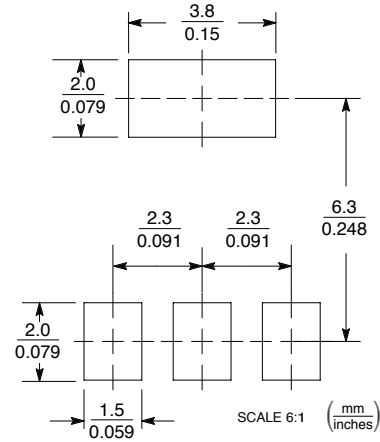

Dim	Inches			Millimeters		
	Min	Nom	Max	Min	Nom	Max
A	---	---	0.071	---	---	1.80
A1	0.001	0.003	0.005	0.02	0.07	0.13
b	0.026	0.030	0.033	0.66	0.75	0.84
b1	0.114	0.118	0.122	2.90	3.00	3.10
c	0.009	0.011	0.014	0.23	0.29	0.35
D	0.260	0.260	0.264	6.60	6.60	6.71
E	0.130	0.138	0.146	3.30	3.50	3.70
e	---	0.091	---	---	2.30	---
e1	0.030	0.037	0.045	0.75	0.95	1.15
L1	0.059	0.069	0.079	1.50	1.75	2.00
HE	0.268	0.276	0.283	6.80	7.00	7.20
∅	0°	---	10°	0°	---	10°

1. DIMENSIONING AND TOLERANCING PER ANSI Y14.5M, 1982.
2. CONTROLLING DIMENSION: INCH.

## Ordering Information

Device	Package	Shipping
Z0103MNT1G	SOT-223 (Pb-Free)	1000 / Tape & Reel
Z0107MNT1G	SOT-223 (Pb-Free)	
Z0109MNT1G	SOT-223 (Pb-Free)	

## Part Marking System

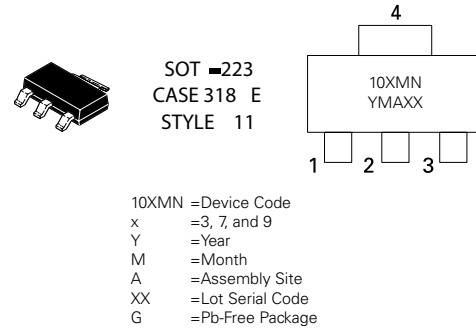

(Note: Microdot may be in either location)

## Pin Assignment

Pin	Assignment
1	Main Terminal 1
2	Main Terminal 2
3	Gate
4	Main Terminal 2

**Disclaimer Notice** - Information furnished is believed to be accurate and reliable. However, users should independently evaluate the suitability of and test each product selected for their own applications. Littelfuse products are not designed for, and may not be used in, all applications. Read complete Disclaimer Notice at: [www.littelfuse.com/disclaimer-electronics](http://www.littelfuse.com/disclaimer-electronics)



Компания «Океан Электроники» предлагает заключение долгосрочных отношений при поставках импортных электронных компонентов на взаимовыгодных условиях!

Наши преимущества:

- Поставка оригинальных импортных электронных компонентов напрямую с производств Америки, Европы и Азии, а так же с крупнейших складов мира;
- Широкая линейка поставок активных и пассивных импортных электронных компонентов (более 30 млн. наименований);
- Поставка сложных, дефицитных, либо снятых с производства позиций;
- Оперативные сроки поставки под заказ (от 5 рабочих дней);
- Экспресс доставка в любую точку России;
- Помощь Конструкторского Отдела и консультации квалифицированных инженеров;
- Техническая поддержка проекта, помощь в подборе аналогов, поставка прототипов;
- Поставка электронных компонентов под контролем ВП;
- Система менеджмента качества сертифицирована по Международному стандарту ISO 9001;
- При необходимости вся продукция военного и аэрокосмического назначения проходит испытания и сертификацию в лаборатории (по согласованию с заказчиком);
- Поставка специализированных компонентов военного и аэрокосмического уровня качества (Xilinx, Altera, Analog Devices, Intersil, Interpoint, Microsemi, Actel, Aeroflex, Peregrine, VPT, Syfer, Eurofarad, Texas Instruments, MS Kennedy, Miteq, Cobham, E2V, MA-COM, Hittite, Mini-Circuits, General Dynamics и др.);

Компания «Океан Электроники» является официальным дистрибьютором и эксклюзивным представителем в России одного из крупнейших производителей разъемов военного и аэрокосмического назначения «JONHON», а так же официальным дистрибьютором и эксклюзивным представителем в России производителя высокотехнологичных и надежных решений для передачи СВЧ сигналов «FORSTAR».



## JONHON

«JONHON» (основан в 1970 г.)

Разъемы специального, военного и аэрокосмического назначения:

(Применяются в военной, авиационной, аэрокосмической, морской, железнодорожной, горно- и нефтедобывающей отраслях промышленности)

«FORSTAR» (основан в 1998 г.)

ВЧ соединители, коаксиальные кабели, кабельные сборки и микроволновые компоненты:

(Применяются в телекоммуникациях гражданского и специального назначения, в средствах связи, РЛС, а так же военной, авиационной и аэрокосмической отраслях промышленности).



Телефон: 8 (812) 309-75-97 (многоканальный)

Факс: 8 (812) 320-03-32

Электронная почта: [ocean@oceanchips.ru](mailto:ocean@oceanchips.ru)

Web: <http://oceanchips.ru/>

Адрес: 198099, г. Санкт-Петербург, ул. Калинина, д. 2, корп. 4, лит. А