

SST-90 LEDs

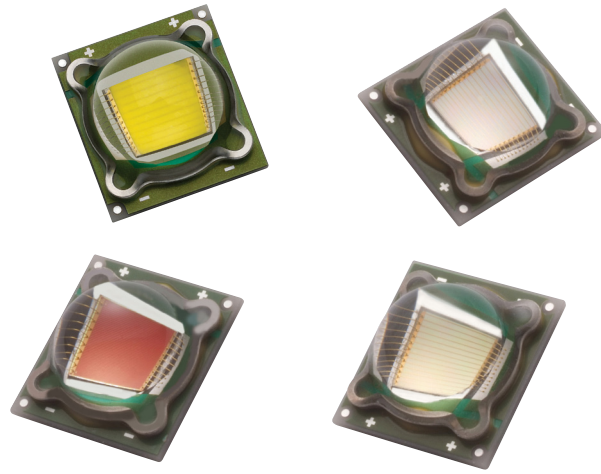

Table of Contents

Technology Overview	2
Test Specifications	2
White Binning Structure	3
White Chromaticity Bins	4
Monochromatic Binning structure	8
Product Shipping & Labeling Information	9
Electrical Characteristics	10
SST-90 W Lifetime & Lumen Maintenance	11
Spectral Characteristics	11
SST-90- RGB Electrical Characteristics	12
Radiation Patterns	17
Thermal Resistance	17
Mechanical Dimensions	18
Solder Profile	20
Ordering Information	21

Features:

- Extremely high optical output:
 - Over 2,100 White Lumens
 - Over 500 Red Lumens
 - Over 950 Green Lumens
 - Over 200 Blue Lumens
- Extremely high efficiency: Over 100 lumens per watt at 3.15A for white
- High thermal conductivity package - junction to case thermal resistance of only 0.64 °C/W
- Large, monolithic chip with uniform emitting area of 9 mm²
- Lumen maintenance of greater than 70% after 60,000 hours
- Environmentally friendly: RoHS compliant
- Variable drive currents: less than 1 A through 9 A
- High reliability
- Electrically isolated thermal path

Applications

- Replacement Lamps
- Architectural Lighting
- Retail Lighting
- Residential Lighting
- Consumer Portable
- Spot Lighting
- High Bay Lighting
- Wide Area Lighting
- Street Lighting
- Medical Lighting
- Emergency Vehicle Lighting
- Displays and Signage

Technology Overview

Luminus Big Chip LEDs™ benefit from a suite of innovations in the fields of chip technology, packaging and thermal management. These breakthroughs allow illumination engineers and designers to achieve solutions that are high brightness and high efficiency.

Photonic Lattice Technology

Luminus' photonic lattice technology enables large area LED chips with uniform brightness over the entire LED chip surface. The optical power and brightness produced by these large monolithic chips enable solutions which replace arc and halogen lamps where arrays of traditional high power LEDs cannot.

For red, green and blue LEDs, the photonic lattice structures extract more light and create radiation patterns that are more collimated than traditional LEDs. Having higher collimation from the source increases optical collection efficiencies and simplifies optical designs.

Packaging Technology

Thermal management is critical in high power LED applications. With a thermal resistance from junction to case of 0.64° C/W. Luminus SST-90 LEDs have the lowest thermal resistance of any LED on the market. This allows the LED to be driven at higher current densities while maintaining a low junction temperature, thereby resulting in brighter solutions

and longer lifetimes.

Reliability

Designed from the ground up, Luminus Big Chip LEDs are one of the most reliable light sources in the world today. Big Chip LEDs have passed a rigorous suite of environmental and mechanical stress tests, including mechanical shock, vibration, temperature cycling and humidity, and have been fully qualified for use in extreme high power and high current applications. With very low failure rates and median lifetimes that typically exceed 60,000 hours, Luminus Big Chip LEDs are ready for even the most demanding applications.

Environmental Benefits

Luminus LEDs help reduce power consumption and the amount of hazardous waste entering the environment. All Big Chip LED products manufactured by Luminus are RoHS compliant and free of hazardous materials, including lead and mercury.

Understanding Big Chip LED Test Specifications

Every Luminus LED is fully tested to ensure that it meets the high quality standards expected from Luminus' products.

Testing Temperature

Luminus core board products are typically measured in such a way that the characteristics reported agree with how the devices will actually perform when incorporated into a system. This measurement is accomplished by mounting the devices on a 40°C heat sink and allowing the device to reach thermal equilibrium while fully powered. Only after the device reaches equilibrium are the measurements taken. This method of measurement ensures that Luminus Big Chip LEDs perform in the field just as they are specified.

Luminus surface mount LEDs are typically tested with a 20mSec input pulse and a junction temperature of 25°C. Expected flux values in real world operation can be extrapolated based on the information contained within this product data sheet.

Multiple Operating Points (3.15, 6.3, 9.0 A)

The tables on the following pages provide typical optical and electrical characteristics. Since the LEDs can be operated over a wide range of drive conditions (currents from less than 1.0 A to 9.0 A, and duty cycle from <1% to 100%), multiple drive conditions are listed.

SST-90 LEDs are production tested at 3.15 A. The values shown at other 6.3 A and 9.0 A are for additional reference at other possible drive conditions.

SST-90 White Binning Structure

SST-90 white LEDs are tested for luminous flux and chromaticity at a drive current of 3.15 A (350 mA/mm²) and placed into one of the following luminous flux (FF) and chromaticity (WW) bins:

Flux Bins

Flux Bin (FF)	Minimum Flux (lm) @ 3.15A	Maximum Flux (lm) @ 3.15A
L2	630	665
L3	665	700
M	700	850
M2	750	800
M3	800	850
N	850	1,000
N2	900	950
N3	950	1,000

*Note: Luminus maintains a +/- 6% tolerance on flux measurements.

Chromaticity Bins

Luminus' Standard Chromaticity Bins: 1931 CIE Curve

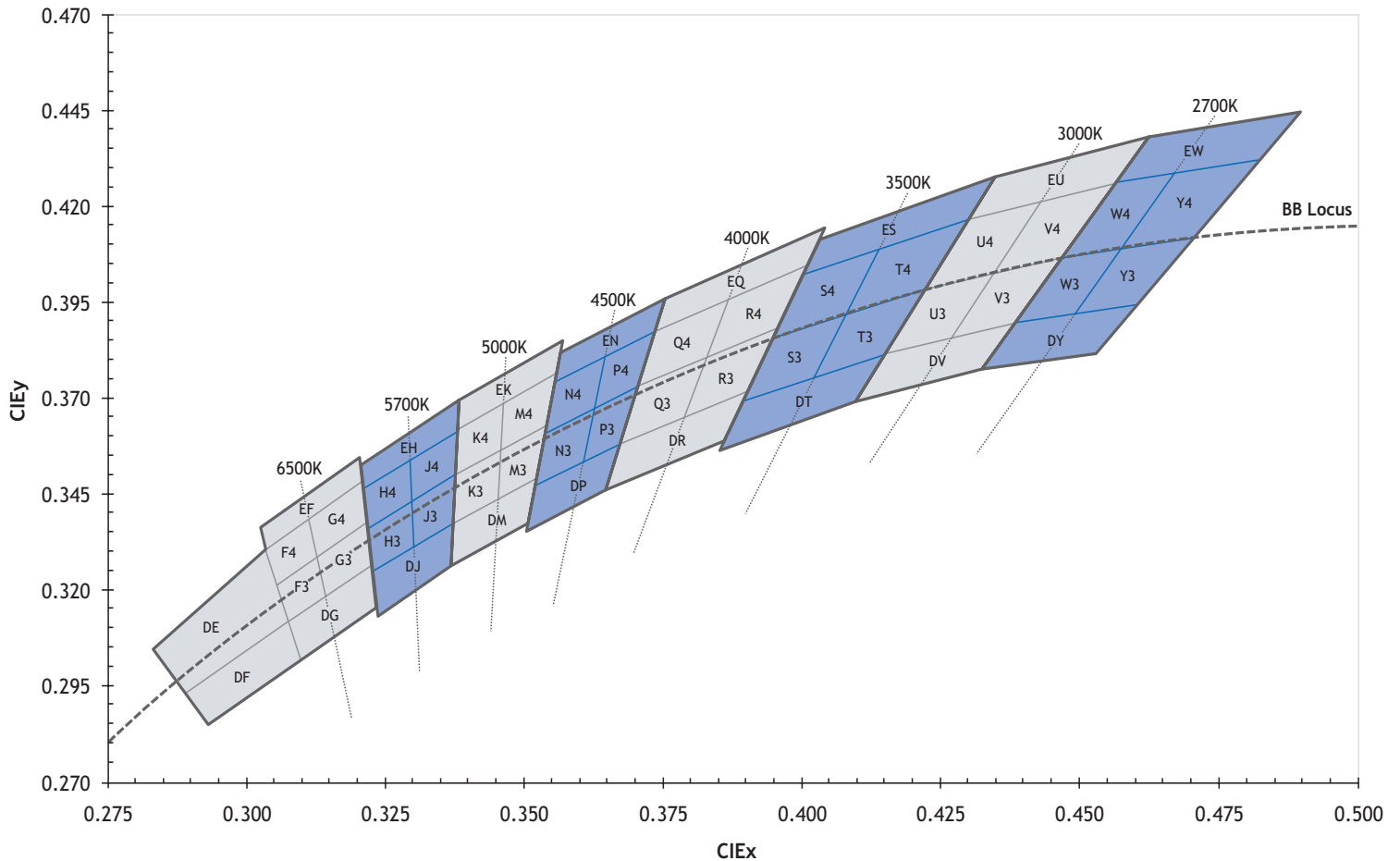

The following tables describe the four chromaticity points that bound each chromaticity bin. Chromaticity bins are grouped together based on the color temperature.

6500K Chromaticity Bins		
Bin Code (WW)	CIEx	CIEy
DG	0.307	0.311
	0.322	0.326
	0.323	0.316
	0.309	0.302
F3*	0.305	0.321
	0.313	0.329
	0.315	0.319
	0.307	0.311
F4*	0.303	0.330
	0.312	0.339
	0.313	0.329
	0.305	0.321
G3*	0.313	0.329
	0.321	0.337
	0.322	0.326
	0.315	0.319
G4*	0.312	0.339
	0.321	0.348
	0.321	0.337
	0.313	0.329
EF	0.302	0.335
	0.320	0.354
	0.321	0.348
	0.303	0.330
DE	0.283	0.304
	0.303	0.330
	0.307	0.311
	0.289	0.293
DF	0.289	0.293
	0.307	0.311
	0.309	0.302
	0.293	0.285

5700K Chromaticity Bins		
Bin Code (WW)	CIEx	CIEy
DJ	0.322	0.324
	0.337	0.337
	0.336	0.326
	0.323	0.314
H3*	0.321	0.335
	0.329	0.342
	0.329	0.331
	0.322	0.324
H4*	0.321	0.346
	0.329	0.354
	0.329	0.342
	0.321	0.335
J3*	0.329	0.342
	0.337	0.349
	0.337	0.337
	0.330	0.331
J4*	0.329	0.354
	0.338	0.362
	0.337	0.349
	0.329	0.342
EH	0.320	0.352
	0.338	0.368
	0.338	0.362
	0.321	0.346

*Sub-bins within ANSI defined quadrangles per ANSI C78.377-2008

5000K Chromaticity Bins		
Bin Code (WW)	CIEx	CIEy
EK	0.338	0.368
	0.356	0.384
	0.355	0.376
	0.338	0.362
K3*	0.337	0.349
	0.345	0.355
	0.345	0.343
	0.337	0.337
K4*	0.338	0.362
	0.347	0.369
	0.345	0.355
	0.337	0.349
M3*	0.345	0.355
	0.353	0.349
	0.352	0.372
	0.344	0.343
M4*	0.346	0.369
	0.355	0.376
	0.353	0.362
	0.345	0.355
DM	0.337	0.337
	0.352	0.349
	0.350	0.337
	0.336	0.326

4500K Chromaticity Bins		
Bin Code (WW)	CIEx	CIEy
EN	0.356	0.384
	0.376	0.396
	0.374	0.387
	0.355	0.374
N3*	0.353	0.360
	0.361	0.366
	0.359	0.352
	0.351	0.347
N4*	0.355	0.374
	0.364	0.381
	0.361	0.366
	0.353	0.360
P3*	0.361	0.366
	0.370	0.373
	0.367	0.358
	0.359	0.352
P4*	0.364	0.381
	0.374	0.387
	0.370	0.373
	0.361	0.366
DP	0.351	0.347
	0.367	0.358
	0.364	0.346
	0.350	0.335

*Sub-bins within ANSI defined quadrangles per ANSI C78.377-2008

4000K Chromaticity Bins		
Bin Code (WW)	CIE _x	CIE _y
EQ	0.376	0.396
	0.404	0.414
	0.401	0.404
	0.374	0.387
Q3*	0.370	0.373
	0.382	0.380
	0.378	0.365
	0.367	0.358
Q4*	0.374	0.387
	0.387	0.396
	0.382	0.380
	0.370	0.373
R3*	0.382	0.380
	0.395	0.388
	0.390	0.372
	0.378	0.365
R4*	0.387	0.396
	0.401	0.404
	0.395	0.388
	0.382	0.380
DR	0.367	0.358
	0.390	0.372
	0.386	0.359
	0.364	0.346

3500K Chromaticity Bins		
Bin Code (WW)	CIE _x	CIE _y
ES	0.403	0.411
	0.435	0.427
	0.430	0.417
	0.400	0.402
S3*	0.394	0.385
	0.407	0.392
	0.402	0.375
	0.389	0.369
S4*	0.400	0.402
	0.415	0.409
	0.407	0.392
	0.394	0.385
T3*	0.407	0.392
	0.422	0.399
	0.415	0.381
	0.402	0.375
T4*	0.415	0.409
	0.430	0.417
	0.422	0.399
	0.407	0.392
DT	0.389	0.369
	0.415	0.381
	0.409	0.369
	0.385	0.357

*Sub-bins within ANSI defined quadrangles per ANSI C78.377-2008

3000K Chromaticity Bins		
Bin Code (WW)	CIE _x	CIE _y
EU	0.435	0.427
	0.462	0.437
	0.456	0.426
	0.430	0.417
U3*	0.422	0.399
	0.434	0.403
	0.426	0.385
	0.415	0.381
U4*	0.430	0.417
	0.443	0.421
	0.434	0.403
	0.422	0.399
V3*	0.434	0.403
	0.447	0.408
	0.437	0.389
	0.426	0.385
V4*	0.443	0.421
	0.456	0.426
	0.447	0.408
	0.434	0.403
DV	0.415	0.381
	0.437	0.389
	0.431	0.377
	0.409	0.369

2700K Chromaticity Bins		
Bin Code (WW)	CIE _x	CIE _y
EW	0.462	0.437
	0.488	0.444
	0.481	0.432
	0.456	0.426
W3*	0.447	0.408
	0.458	0.410
	0.448	0.392
	0.437	0.389
W4*	0.456	0.426
	0.469	0.429
	0.458	0.410
	0.447	0.408
Y3*	0.458	0.410
	0.70	0.413
	0.459	0.394
	0.448	0.392
Y4*	0.469	0.429
	0.481	0.432
	0.470	0.413
	0.458	0.410
DY	0.437	0.389
	0.459	0.394
	0.452	0.382
	0.431	0.377

*Sub-bins within ANSI defined quadrangles per ANSI C78.377-2008

SST-90 RGB Bins Structure

SST-90 RGB LEDs are specified for luminous flux and wavelength at a drive current of 3.15 A (0.35 A/mm²) and placed into one of the following luminous flux (FF) and wavelength (WW) bins:

Flux Bins

Color	Luminous Flux Bin (FF)	Minimum Flux (lm) @ 3.15A	Maximum Flux (lm) @ 3.15A
Red	BG	275	350
	BH	350	475
Green	CF	640	775
	CG	775	940
Blue	DE	90	120
	DF	120	160
	DG	160	200

Wavelength Bins

Color	Wavelength Bin (FF)	Minimum Wavelength @ 3.15A	Maximum Wavelength @ 3.15A
Red	R2	611	615
	R3	615	619
	R4	619	623
	R5	623	627
	R6	627	631
	R7	631	635
Green	G2	510	515
	G3	515	520
	G4	520	525
	G5	525	530
	G6	530	535
	G7	535	540
	G8	540	545
Blue	B4	450	455
	B5	455	460
	B6	460	465
	B7	465	470
	B8	470	475

Note 1: Luminus maintains a +/- 6% tolerance on flux measurements.

Note 2: Only specific bins are available for large order, contact Luminus sales team for more information.

Product Shipping & Labeling Information

All SST-90 products are packaged and labeled with their respective bin as outlined in the tables and charts from pages 3 to 8. When shipped, each package will only contain one bin. The part number designation is as follows:

SST — 90 — WNNX — F11 — FF — WW

Product Family	Chip Area	Color	Package Configuration	Flux Bin	Chromaticity Bin
Surface Mount (Lens)	9.0 mm ²	CCT & CRI See Note 1 below	Internal Code	See page 3 for bins	See page 4-7 for bins

Note 1: WNNX nomenclature corresponds to the following:

W = White

NN = color temperature, where:

65 corresponds to 6500K

X = color rendering index, where:

S (standard) corresponds to a typical CRI of 70

Example 1:

The part number SST-90-W65S-F11-N3-G4 refers to a 6500K standard CRI white, SST-90 emitter, with a flux range from 950 to 1,000 lumens and a chromaticity value within the box defined by the four points (0.313, 0.338), (0.321, 0.348), (0.322, 0.336), (0.312, 0.328).

SST — 90 — X — F11 — FF — WW

Product Family	Chip Area	Color	Package Configuration	Flux Bin	Wavelength Bin
Surface Mount (Lens)	9.0 mm ²	R: Red G: Green B: Blue	Internal Code	See page 8 for bins	See page 8 for bins

Example 2:

The part number SST-90-R-C11-BJ-R4 refers to a red, SST-90 surface mount, with a flux range of 475-600 lumens and a wavelength range of 619 nm to 623 nm.

Note 2: Some flux and chromaticity/ wavelength bins may have limited availability. Application specific bin kits, consisting of multiple bins, may be available. For ordering information, please refer to page 21 and reference the PDS-001692: SST-90 Binning & Labeling document.

Electrical Characteristics¹

Optical and Electrical Characteristics (T_j = 25 °C)

Drive Condition ²		3.15 A	9.0 A	
Parameter	Symbol	Values at Test Currents	Typical Values at Indicated Current ³	Unit
Current Density	j	0.35	1.0	A/mm ²
Forward Voltage	V _{F, min}	2.5		V
	V _{F, typ}	3.25	3.87	V
	V _{F, max}	3.9		V

Common Characteristics

Parameter	Symbol	Values	Unit
Viewing Angle	2 θ _{1/2}	100	
Emitting Area		9.0	mm ²
Emitting Area Dimensions		3 x 3	mm×mm
Forward Voltage Temperature Coefficient ⁴		-2.45	mV/°C

Absolute Maximum Ratings

Parameter	Symbol	Values	Unit
Maximum Current ⁵		9.0	A
Maximum Reverse Current		N/A	
Maximum Junction Temperature ⁶	T _{j-max}	150	°C
Storage Temperature Range		-40/+100	°C

Note 1: Listed drive conditions are typical for common applications. SST-90 White devices can be driven at currents ranging from <1A to 9A and at duty cycles ranging from <1% to 100%. Drive current and duty cycle should be adjusted as necessary to maintain the junction temperature desired to meet application lifetime requirements.

Note 2: Unless otherwise noted, values listed are typical.

Note 3: Forward voltage temperature coefficient at 3.15A. Contact Luminus for value at other drive conditions.

Note 4: SST-90 White devices are designed for operation to an absolute maximum forward drive current 9A. Product lifetime data is specified at recommended forward drive currents. Sustained operation at absolute maximum currents will result in a reduction of device lifetime compared to recommended forward drive currents. Actual device lifetimes will also depend on junction temperature. Refer to APN-001522: Reliability Application Note for SST-90-W for further information. In pulsed operation, rise time from 10-90% of forward current should be larger than 0.5 microseconds.

Note 5: Lifetime dependent on LED junction temperature. Thermal calculations based on input power and thermal management system should be performed to ensure T_j is maintained below T_{j-max} rating or life will be reduced. Refer to APN-001522 for further information.

Note 6: CIE measurement uncertainty for white devices is estimated to be +/- 0.01.

Note 7: Special design considerations must be observed for operation under 1A. Please contact Luminus for further information.

Note 8: Caution must be taken not to stare at the light emitted from these LEDs. Under special circumstances, the high intensity could damage the eye.

Relative Output Flux vs. Forward Current¹

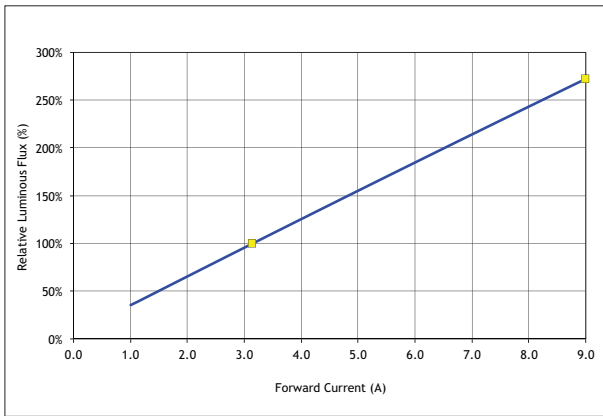

Forward Current vs. Forward Voltage

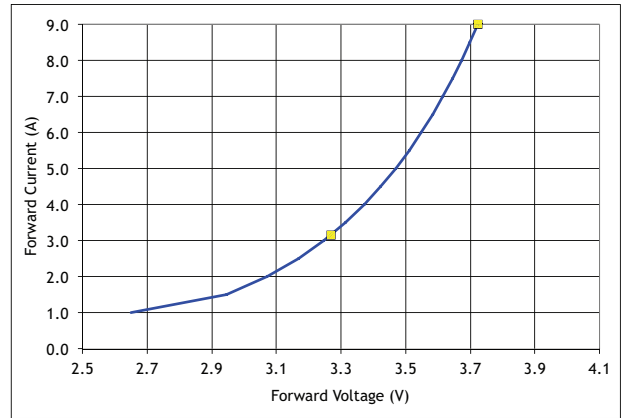

Mean Lifetime²

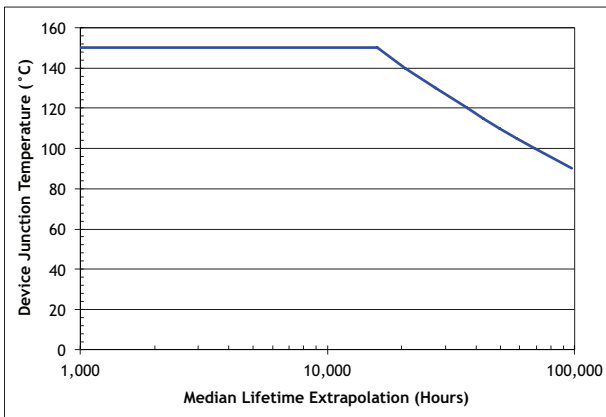

Lumen Maintenance vs. Time³

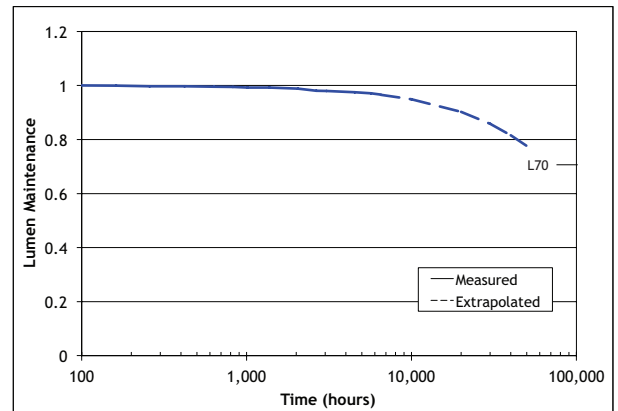

Typical Relative Spectral Power⁴

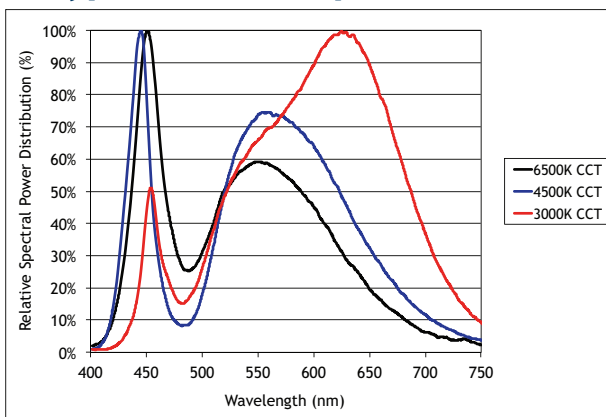

Current Derating Curve

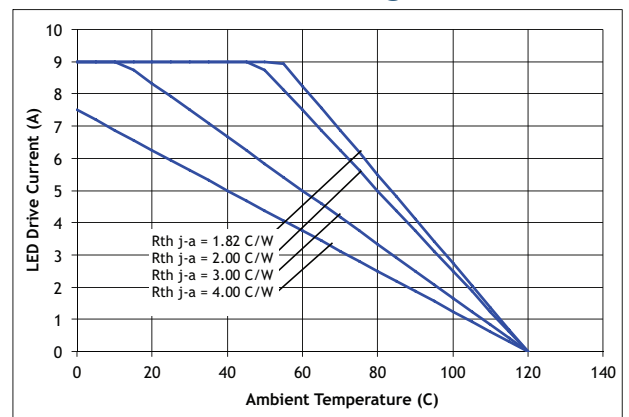

Note 1: Yellow squares indicate typical operating conditions.

Note 2: Mean expected lifetime in dependence of junction temperature at 0.35 A/mm² in continuous operation. Lifetime defined as time to 70% of initial intensity. Based on lifetime test data of uncoated GaN devices at this time. Data can be used to model failure rate over typical product lifetime (contact Luminus for lifetime reliability test data for 1A/mm² condition).

Note 3: Lumen maintenance in dependence of time at 0.35 A/mm² in continuous operation with junction temperatures of 100 °C.

Note 4: Typical spectrum at current density of 0.35 A/mm² in continuous operation.

Optical & Electrical Characteristics

Red					
Drive Condition ²		3.2 A Continuous	6.3 A Continuous		
Parameter	Symbol	Values ³		Unit	
Current Density	j	0.35	0.7	A/mm ²	
Forward Voltage	V _{Fmin}	TBD	-	V	
	V _F	2.0	2.2	V	
	V _{Fmax}	TBD	-	V	
Luminous Flux ⁴	Φ _{V,typ}	400	640	lm	
Dominant Wavelength ⁵	λ _d	624	624	nm	
FWHM	Δλ _{1/2}	16	19	nm	
Chromaticity Coordinates ^{6,7}	x	0.695	0.699	-	
	y	0.305	0.301	-	

Relative Output Flux vs. Forward Current¹

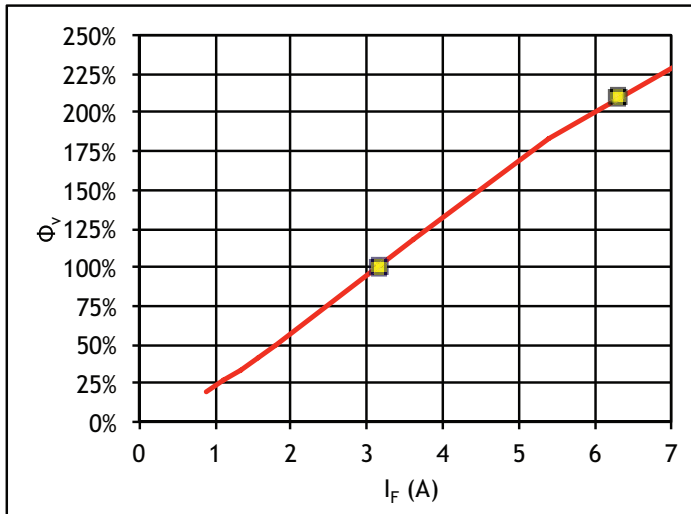

Forward Current vs. Forward Voltage

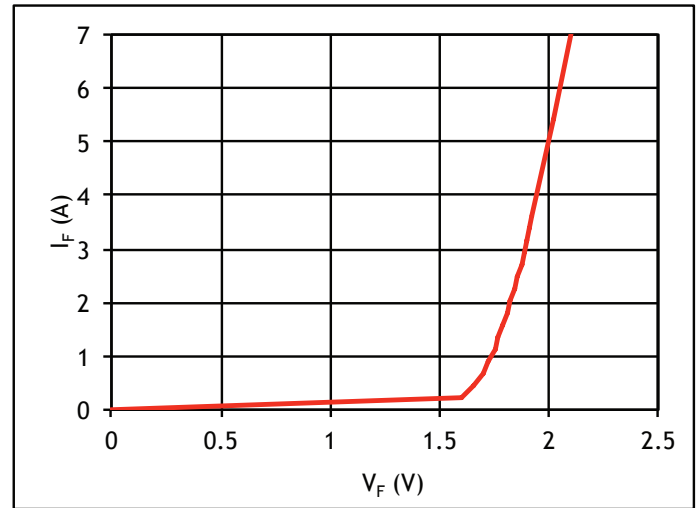

Yellow squares indicate reference drive conditions

Notes: See page 15

Optical & Electrical Characteristics

Green					
Drive Condition ²		3.15 A Continuous	6.3 A Continuous		
Parameter	Symbol	Values ³		Unit	
Current Density	j	0.35	0.7	A/mm ²	
Forward Voltage	V _{Fmin}	TBD		V	
	V _F	3.4	3.7	V	
	V _{Fmax}	TBD		V	
Luminous Flux ⁴	Φ _{V,typ}	855	1485	lm	
Dominant Wavelength ⁵	λ _d	537	533	nm	
FWHM	Δλ _{1/2}	35	38	nm	
Chromaticity Coordinates ^{6,7}	x	0.205	0.175	-	
	y	0.740	0.730	-	

Relative Output Flux vs. Forward Current¹



Forward Current vs. Forward Voltage

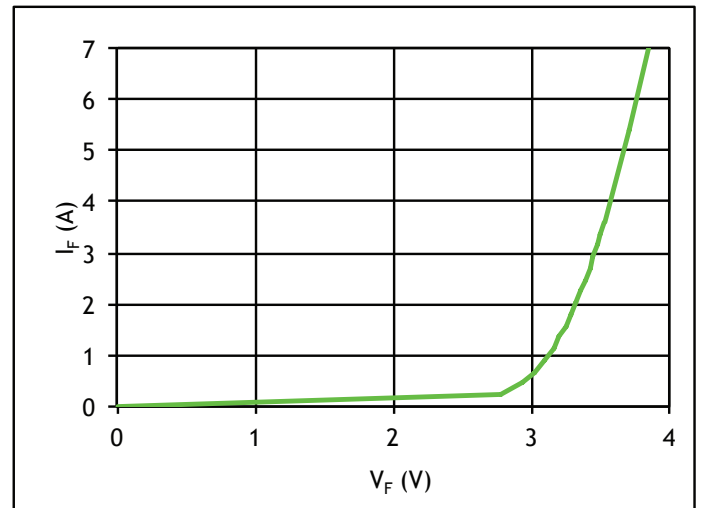

Yellow squares indicate reference drive conditions

Notes: See page 15

Optical & Electrical Characteristics

Blue					
Drive Condition ²		3.15 A Continuous	6.3 A Continuous		
Parameter	Symbol	Values ³		Unit	
Current Density	j	0.35	0.7	A/mm ²	
Forward Voltage	V _{Fmin}	TBD		V	
	V _F	3.4	3.6	V	
	V _{Fmax}	TBD		V	
Luminous Flux ⁴	Φ _{v,typ}	180	315	lm	
Dominant Wavelength ⁵	λ _d	465	464	nm	
FWHM	Δλ _{1/2}	21	24	nm	
Chromaticity Coordinates ^{6,7}	x	0.142	0.142	0.142	
	y	0.036	0.038	0.038	

Relative Output Flux vs. Forward Current¹

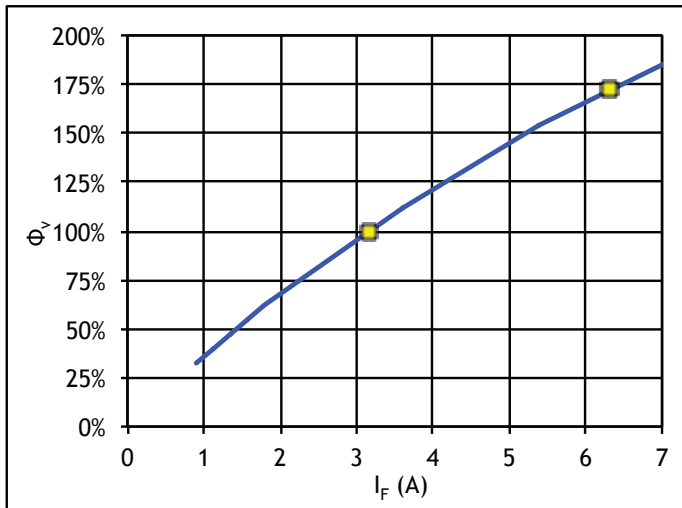

Forward Current vs. Forward Voltage

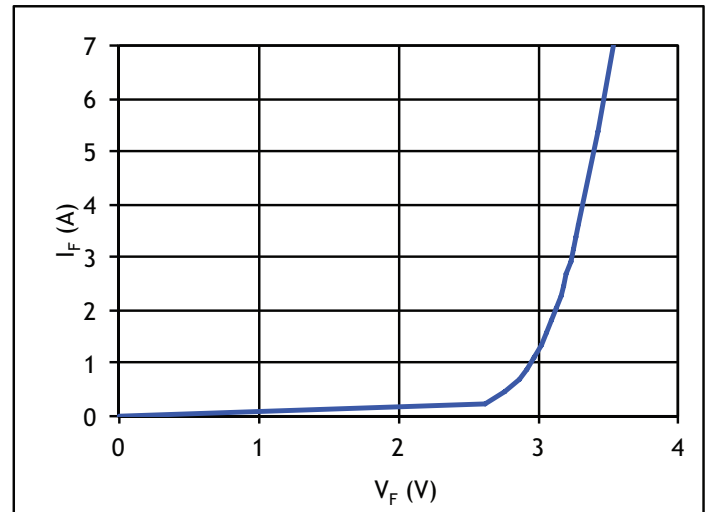

Yellow squares indicate reference drive conditions

Notes: See page 15

Optical & Electrical Characteristics Notes

- Note 1: All ratings are based on a junction test temperature $T_j = 25^\circ\text{C}$. See Thermal Resistance section for T_j definition.
- Note 2: Listed drive conditions are typical for common applications. SST-90 RGB devices can be driven at currents ranging from <1 A to 6.3 A and at duty cycles ranging from 1% to 100%. Drive current and duty cycle should be adjusted as necessary to maintain the junction temperature desired to meet application lifetime requirements.
- Note 3: Unless otherwise noted, values listed are typical. Devices are production tested and specified at 0.35mA. Other values are for reference only.
- Note 4: Total flux from emitting area at listed dominant wavelength. Reported performance is included to show trends for a selected power level. For specific minimum and maximum values, use bin tables. For product roadmap and future performance of devices, contact Luminus.
- Note 5: Minimum and Maximum Dominant Wavelengths are based on typical values +/- 5nm for Red, +/- 8nm for Green and +/- 6nm for Blue.
- Note 6: In CIE 1931 chromaticity diagram coordinates, normalized to $X+Y+Z=1$.
- Note 7: For reference only.

Common Characteristics

	Symbol	Red	Green	Blue	Unit
Emitting Area		9.0	9.0	9.0	mm ²
Emitting Area Dimensions		3.0x3.0	3.0x3.0	3.0x3.0	mmxmm
Dynamic Resistance	Ω_{dyn}	0.03	0.04	0.02	Ω
Thermal Coefficient of Photometric Flux		-0.96	-0.18	-0.007	%/ °C
Thermal Coefficient of Radiometric Flux		-0.52	-0.20	-0.17	%/ °C
Thermal Coefficient of Junction Voltage		-1.3	-4.6	-3.5	mV/ °C

Absolute Maximum Ratings

	Symbol	Red	Green	Blue	Unit
Maximum Current		27	27	27ss	A
Maximum Junction Temperature	$T_{j\text{max}}$	125	150	150	°C
Storage Temperature Range		-40/+100	-40/+100	-40/+100	°C

- Note 1: SST-90 RGB LEDs are designed for operation to an absolute maximum current as specified above. Product lifetime data is specified at recommended forward drive currents. Sustained operation at or beyond absolute maximum currents will result in a reduction of device life ime compared to recommended forward drive currents. Actual device lifetimes will also depend on junction temperature. Refer to the lifetime derating curves for further information. In pulsed operation, rise time from 10-90% of forward current should be larger than 0.5 microseconds.
- Note 2: Lifetime dependent on LED junction temperature. Input power and thermal system must be properly managed to ensure lifetime. See charts on pg 16 for further information.

Light Output and Spectral Characteristics Over Heat Sink Temperature

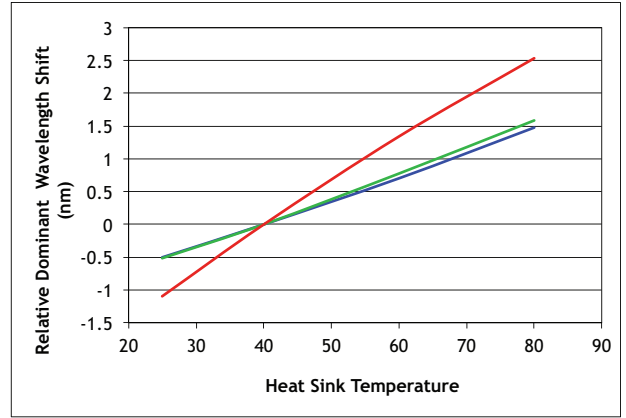

Median Lifetime Estimate vs. T_j^{13}



Lumen Maintenance¹⁴

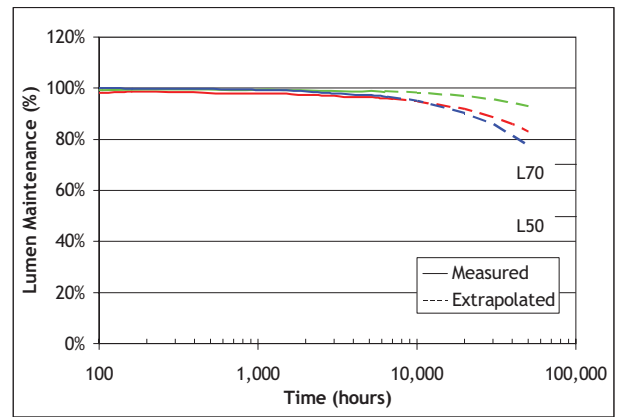

Typical Spectrum¹⁵



Relative Flux vs. Junction Temperature

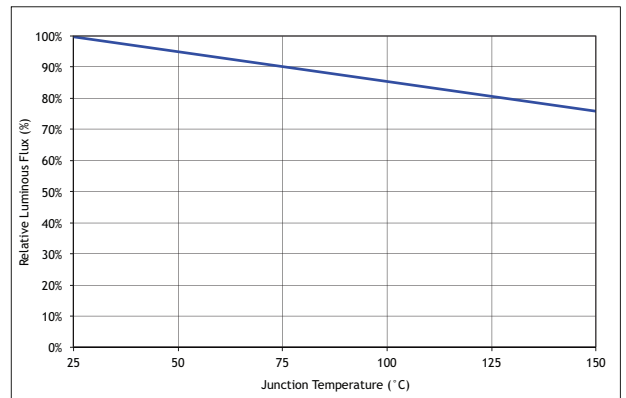

Note 13. Median lifetime estimate as a function of junction temperature at 0.35A/mm² in continuous operation. Lifetime defined as time to 70% of initial intensity. Based on preliminary lifetime test data. Data can be used to model failure rate over typical product lifetime.

Note 14. Lumen maintenance vs. time at 0.35A/mm² in continuous operation, Red junction temperature of 70°C, Green junction temperatures of 120°C, Blue junction temperatures of 100°C.

Note 15. Typical spectrum at current density of 0.35 A/mm² in continuous operation.

Typical Radiation Patterns

Typical Polar Radiation Pattern for White

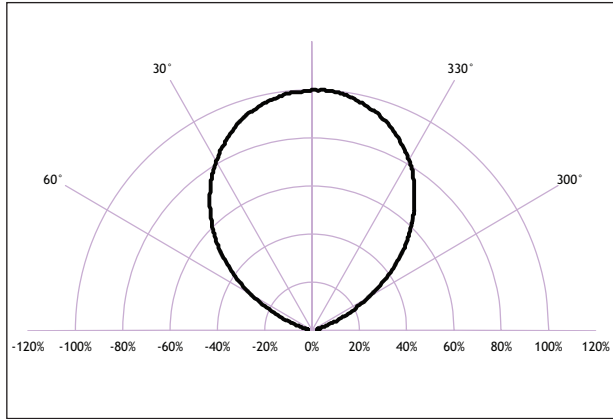

Typical Angular Radiation Pattern for White

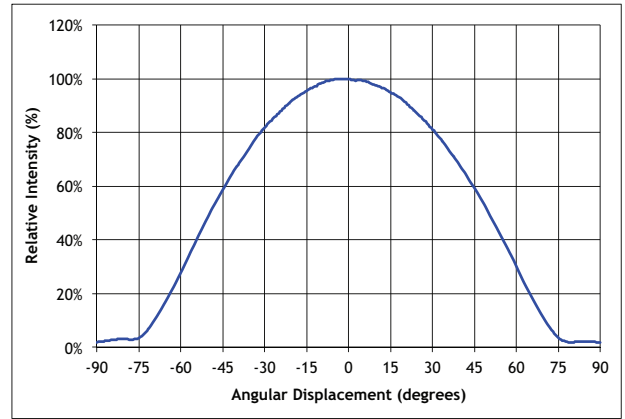

Typical Polar Radiation Pattern for Blue and Green

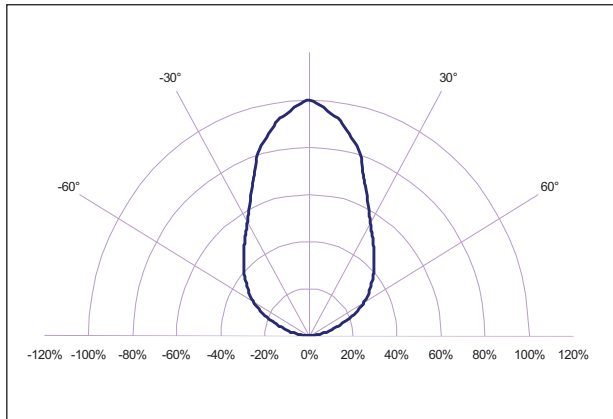

Typical Polar Radiation Pattern for Red

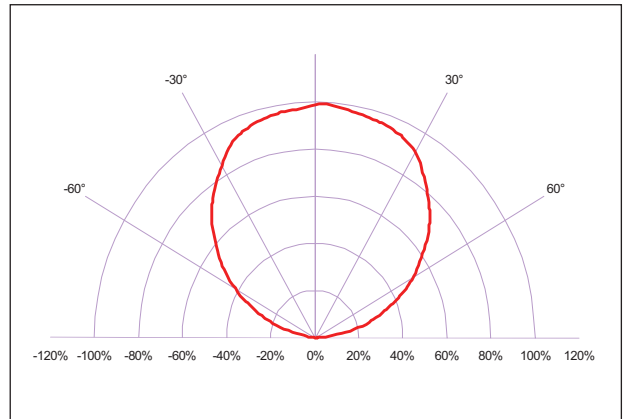

Thermal Resistance



T_{hs} definition = 3 mm from core-board

Typical Thermal Resistance

R_{j-c}^1	0.64 °C/W
R_{j-b}^1	2.02 °C/W
R_{j-hs}^2	2.15 °C/W

Note 1: Thermal resistance values are based on FEA model results correlated to measured $R_{\theta j-hs}$ data.

Note 2: Thermal resistance is measured using a SAC305 solder, a Bergquist Al-clad MCPCB, and eGraf 1205 thermal interface material.

Mechanical Dimensions – SST-90 Emitter

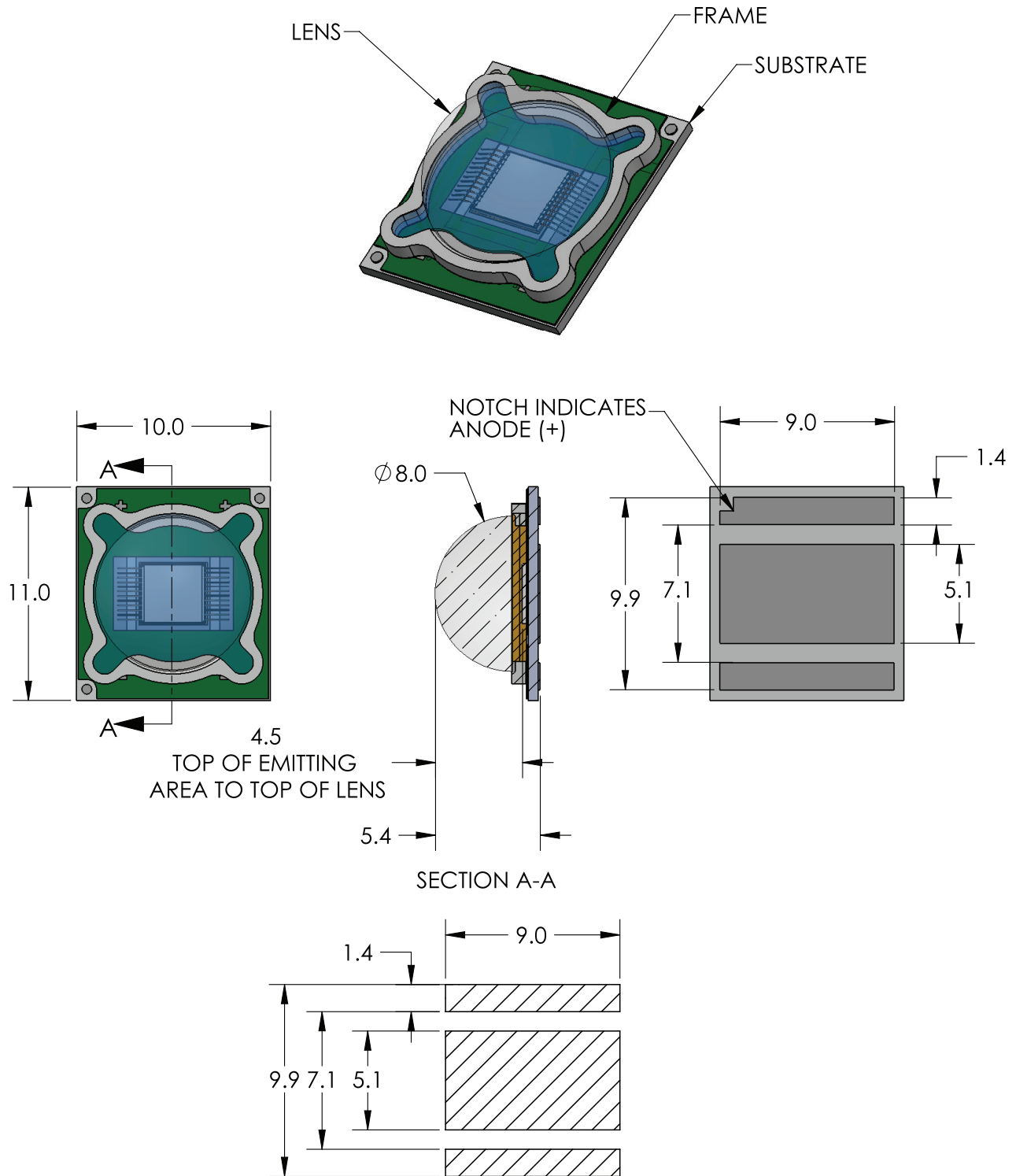

For detailed drawing please refer to DWG-001359 document

Mechanical Dimensions – SST-90 Star Board

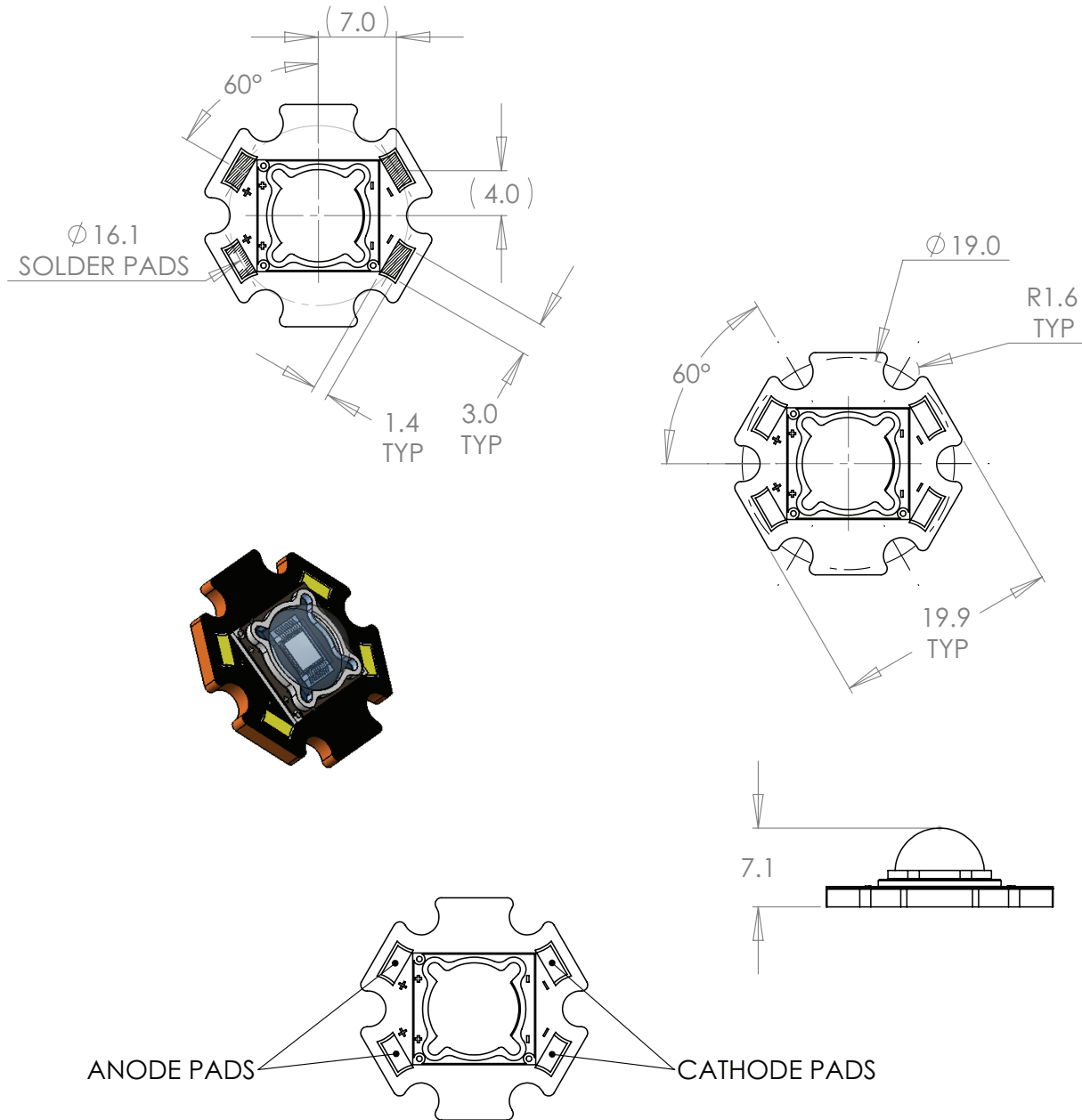

Note 1: Recommended mounting screw: M3 or #4

Note 2: All dimensions in millimeters

Note 3: All anode pads on board are interconnected. All cathode pads on board are interconnected

Solder Profile

SAC 305 Reflow Profile Window For Low Density Boards

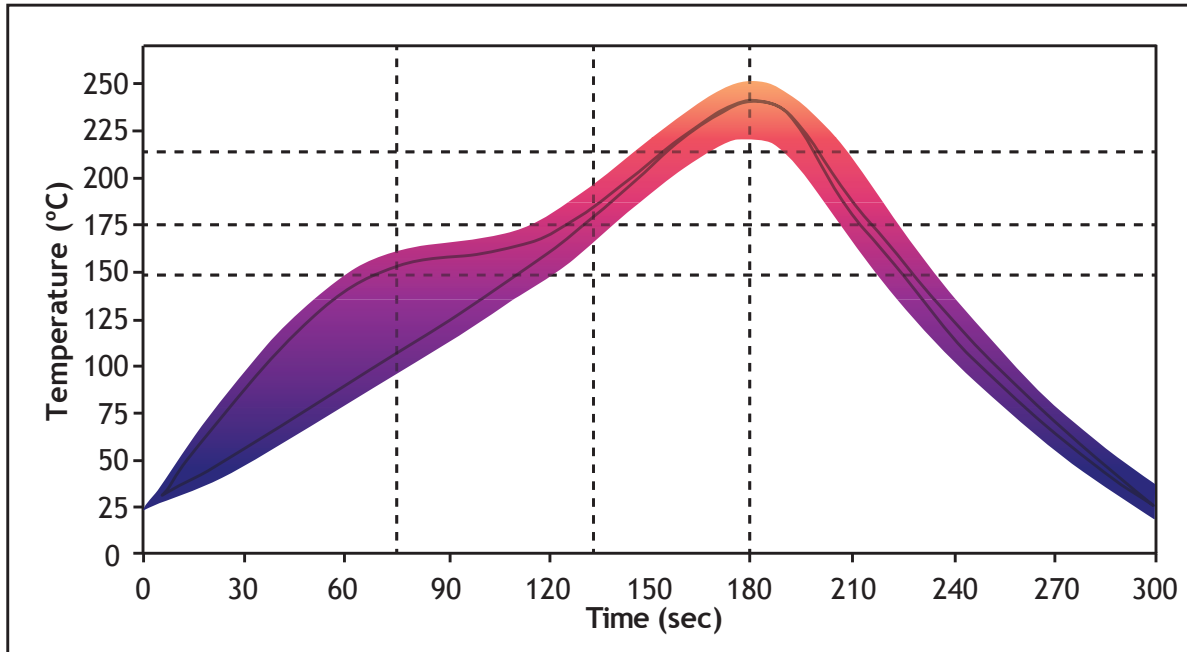

Lead free solder guideline for low density boards

Solder Profile Stage	Lead-Free Solder	Lead-based Solder
Profile length, Ambient to Peak	2.75 - 3.5 minutes	2.75 - 3.5 minutes
Time Maintained Above: Temperature	217 °C	183 °C
Time Maintained Above: Time	30 - 60 seconds	30 - 60 seconds
Cooldown Rate	≤4° C/sec	≤4° C/sec
Cooldown Duration	45 ± 15 sec	45 ± 15 sec

Note 1: Temperatures are taken and monitored at the component copper layer.

Note 2: Optimum profile may differ due to oven type, circuit board or assembly layout.

Note 3: Recommended lead free, no-clean solder: AIM NC254-SAC305.

Note 4: Refer to APN-001473 soldering and handling application note for additional solder profiles and details.

Note 5: MSL- Level 2A

Tape and Reel Drawing

DIMENSIONS ARE IN mm. (INCH)



TAPE DIMENSIONS							
W	ϕA	B	C	D	E	F	
24.0 (.945)	1.5 (.059)	3.9 (.157)	6.1 (.241)	1.7 (.069)	11.5 (.453)	16.0 (.630)	

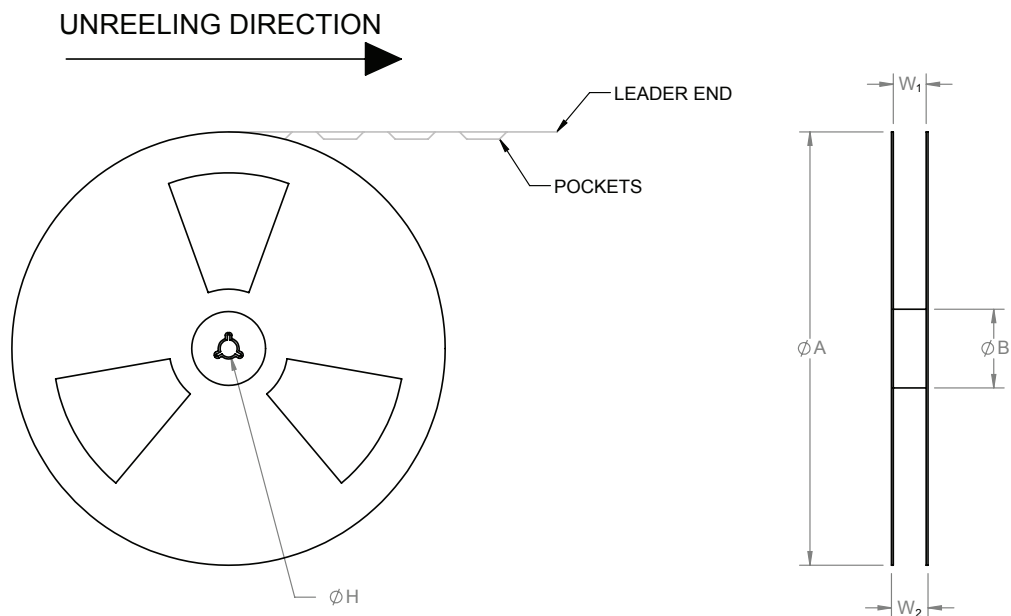

REEL DIMENSIONS				
ϕA	W_1	W_2	ϕB	ϕH

Ordering Information

Ordering Part Number ^{1,2}	Color	Description
SST-90-WDLS-F11-N2150	6500K White 5700K White	White Big Chip LED™ SST-90 surface mount device consisting of a 9mm ² LED on ceramic substrate, tray pack
SST-90-WCLS-F11-GN450	4500K White 4000K White	
SST-90-WWRM-F11-GM750	3000K White 2700K White	
SSR-90-WDLS-R11-N2150	6500K White 5700K White	SSR-90 evaluation module consisting of a SST-90 surface mount device mounted on an aluminum star board
SSR-90-WCLS-R11-GN450	4500K White 4000K White	
SSR-90-WWRM-R11-GM750	3000K White 2700K White	

Note 1: N2150 - denotes a bin kit comprising of all flux and chromaticity bins at the 6500K and 5700K color points
 GN450 - denotes a bin kit comprising of all flux and chromaticity bins at the 4500K and 4000K color points
 GM750 - denotes a bin kit comprising of all flux and chromaticity bins at the 3000K and 2700K color points

Ordering Information

Ordering Part Number ^{1,2,3}	Color	Description
SST-90-R-F11-HH100	Red	Red SST-90 consisting of a 9 mm ² LED on a surface mount substrate
SST-90-G-F11-JG200	Green	Green SST-90 consisting of a 9 mm ² LED on a surface mount substrate
SST-90-B-F11-KF300	Blue	Blue SST-90 consisting of a 9 mm ² LED on a surface mount substrate
SSR-90-R-R11-HH100	Red	Red SSR-90 evaluation module consisting of a SST-90 surface mount device mounted on an aluminum star board
SSR-90-G-R11-JG200	Green	Green SSR-90 evaluation module consisting of a SST-90 surface mount device mounted on an aluminum star board
SSR-90-B-R11-KF300	Blue	Blue SSR-90 evaluation module consisting of a SST-90 surface mount device mounted on an aluminum star board

Note 1: *HH100 - denotes a bin kit comprising of all red flux and wavelength bins as specified on page 5*
JG200 - denotes a bin kit comprising of all green flux and wavelength bins as specified on page 5
KF300 - denotes a bin kit comprising of all blue flux and wavelength bins as specified on page 5

Note 2: *For ordering information on all available bin kits, please see PDS-001692: SST-90 Binning & Labeling document*

The products, their specifications and other information appearing in this document are subject to change by Luminus Devices without notice. Luminus Devices assumes no liability for errors that may appear in this document, and no liability otherwise arising from the application or use of the product or information contained herein. None of the information provided herein should be considered to be a representation of the fitness or suitability of the product for any particular application or as any other form of warranty. Luminus Devices' product warranties are limited to only such warranties as accompany a purchase contract or purchase order for such products. Nothing herein is to be construed as constituting an additional warranty. No information contained in this publication may be considered as a waiver by Luminus Devices of any intellectual property rights that Luminus Devices may have in such information. Big Chip LEDs™ is a registered trademark of Luminus Devices, Inc., all rights reserved.

This product is protected by U.S. Patents 6,831,302; 7,074,631; 7,083,993; 7,084,434; 7,098,589; 7,105,861; 7,138,666; 7,166,870; 7,166,871; 7,170,100; 7,196,354; 7,211,831; 7,262,550; 7,274,043; 7,301,271; 7,341,880; 7,344,903; 7,345,416; 7,348,603; 7,388,233; 7,391,059 Patents Pending in the U.S. and other countries.

Компания «Океан Электроники» предлагает заключение долгосрочных отношений при поставках импортных электронных компонентов на взаимовыгодных условиях!

Наши преимущества:

- Поставка оригинальных импортных электронных компонентов напрямую с производств Америки, Европы и Азии, а так же с крупнейших складов мира;
- Широкая линейка поставок активных и пассивных импортных электронных компонентов (более 30 млн. наименований);
- Поставка сложных, дефицитных, либо снятых с производства позиций;
- Оперативные сроки поставки под заказ (от 5 рабочих дней);
- Экспресс доставка в любую точку России;
- Помощь Конструкторского Отдела и консультации квалифицированных инженеров;
- Техническая поддержка проекта, помощь в подборе аналогов, поставка прототипов;
- Поставка электронных компонентов под контролем ВП;
- Система менеджмента качества сертифицирована по Международному стандарту ISO 9001;
- При необходимости вся продукция военного и аэрокосмического назначения проходит испытания и сертификацию в лаборатории (по согласованию с заказчиком);
- Поставка специализированных компонентов военного и аэрокосмического уровня качества (Xilinx, Altera, Analog Devices, Intersil, Interpoint, Microsemi, Actel, Aeroflex, Peregrine, VPT, Syfer, Eurofarad, Texas Instruments, MS Kennedy, Miteq, Cobham, E2V, MA-COM, Hittite, Mini-Circuits, General Dynamics и др.);

Компания «Океан Электроники» является официальным дистрибьютором и эксклюзивным представителем в России одного из крупнейших производителей разъемов военного и аэрокосмического назначения «JONHON», а так же официальным дистрибьютором и эксклюзивным представителем в России производителя высокотехнологичных и надежных решений для передачи СВЧ сигналов «FORSTAR».



JONHON

«JONHON» (основан в 1970 г.)

Разъемы специального, военного и аэрокосмического назначения:

(Применяются в военной, авиационной, аэрокосмической, морской, железнодорожной, горно- и нефтедобывающей отраслях промышленности)

«FORSTAR» (основан в 1998 г.)

ВЧ соединители, коаксиальные кабели,
кабельные сборки и микроволновые компоненты:

(Применяются в телекоммуникациях гражданского и специального назначения, в средствах связи, РЛС, а так же военной, авиационной и аэрокосмической отраслях промышленности).



Телефон: 8 (812) 309-75-97 (многоканальный)

Факс: 8 (812) 320-03-32

Электронная почта: ocean@oceanchips.ru

Web: <http://oceanchips.ru/>

Адрес: 198099, г. Санкт-Петербург, ул. Калинина, д. 2, корп. 4, лит. А