

LT3845A: High Voltage Synchronous Buck Controller with Programmable Frequency and Sync

DESCRIPTION

Demonstration Circuit 1619A is a 100kHz to 500kHz programmable frequency, high voltage, current mode DC/DC step-down converter featuring the LT[®]3845A. The operating frequency can be synchronized up to 600kHz. This demo board is designed for 12V up to 10A (120W) output from a 16V to 60V input. A soft-start feature controls the output voltage slew rate at start-up, reducing current surges and voltage overshoots. The modes of operation (Burst Mode[®], discontinuous current mode and continuous current mode) are jumper selectable. Both Burst Mode operation and discontinuous current mode increase the efficiency at light loads. Continuous current mode will maintain a constant switching frequency regardless of the load current.

An optional boost bias circuit is provided on the bottom side of the board for back-driving the LT3845A internal regulator from the output voltage. Customers may want to use this optional circuit with modified applications that have relatively high input voltages and low (~3.3V)

output voltages. In such applications, this optional circuit can increase the overall efficiency by reducing the power loss in the LT3845A. The demonstration board has the option of doubling the number of switching MOSFETs to facilitate higher output current. This board is suitable for a wide range of industrial control systems and telecom power supplies.

The LT3845A data sheet gives a complete description of the part, operation and application information. The data sheet must be read in conjunction with this quick start guide for demo circuit 1619A.

Note: It is best to ground the SYNC pin if the SYNC function is not being used.

Design files for this circuit board are available at <http://www.linear.com/demo>

LT, LT, LTC, LTM, Burst Mode, Linear Technology and the Linear logo are registered trademarks of Linear Technology Corporation. All other trademarks are the property of their respective owners.

PERFORMANCE SUMMARY (T_A = 25°C)

PARAMETER FOR BUCK REGULATOR	CONDITION	VALUE
Minimum Input Voltage		16V
Maximum Input Voltage		60V
Output Voltage, V _{OUT}		12V ±2%
Maximum Output Current	V _{IN} < 28V V _{IN} ≥ 28V	7.5A to 10A (See Figure 5) 10A
Typical Switching Frequency	R9 = 49.9k	300kHz
External Clock Synchronous Frequency Range	R9 = 49.9k	325kHz to 600kHz
Efficiency	V _{IN} = 48V, V _{OUT} = 12V, I _{OUT} = 8A	94% (See Figure 3)

QUICK START PROCEDURE

Demonstration circuit 1619A is easy to set up to evaluate the performance of the LT3845A. Refer to Figure 1 for proper measurement equipment setup and follow the procedure below:

Note: When measuring the input or output voltage ripple, care must be taken to avoid a long ground lead on the oscilloscope probe. Measure the input or output voltage ripple directly across the VIN or VOUT capacitors by soldering leads on the appropriate capacitor. See Figure 2 for proper scope probe technique. An oscilloscope probe can be directly connected to VIN or VOUT using a banana jack to BNC adaptors.

1. Place JP1 in the RUN position.
2. Place JP2 in the desired operating mode: burst, pulse-skipping or continuous.
3. With power off, connect the input power supply to VIN and GND.

4. Turn on the power at the input and adjust the input voltage until the LT3845A turns on.

Note: Make sure that the input voltage does not exceed 60V.

5. Check for the proper output voltage.

Note: If output does not come up, make sure the load is not set too high. Reduce the load and repeat steps 4 and 5.

6. Once the proper output voltage is established, adjust the input voltage and load within the operating range and observe the output voltage regulation, ripple voltage, efficiency and other parameters.

7. An external clock can be added to the SYNC pin when the SYNC function is used. See the Oscillator SYNC section in the data sheet for details.

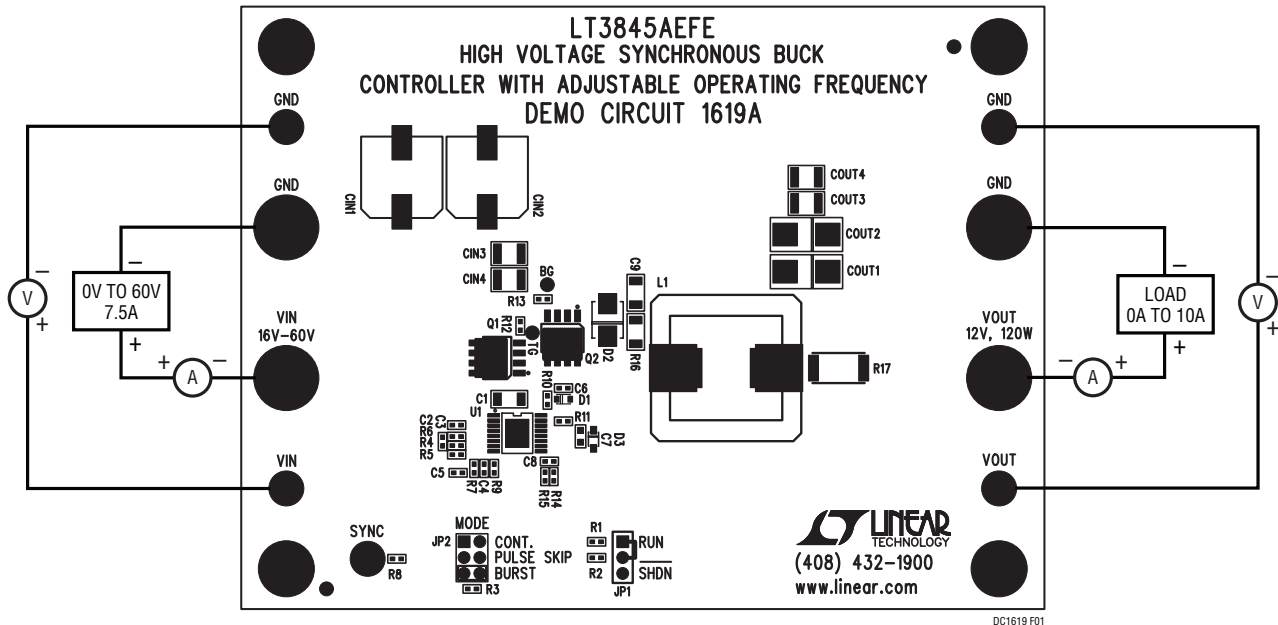

Figure 1. Proper Measurement Equipment Setup

QUICK START PROCEDURE

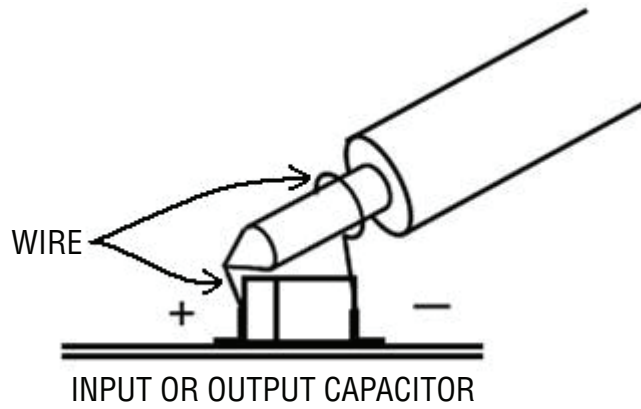

Figure 2. Measuring Input or Output Ripple

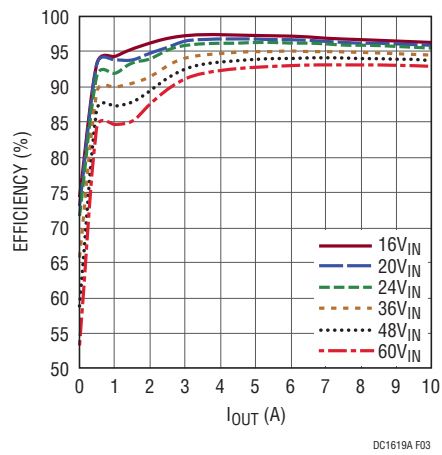

Figure 3. DC1619A Burst Mode Efficiency

QUICK START PROCEDURE

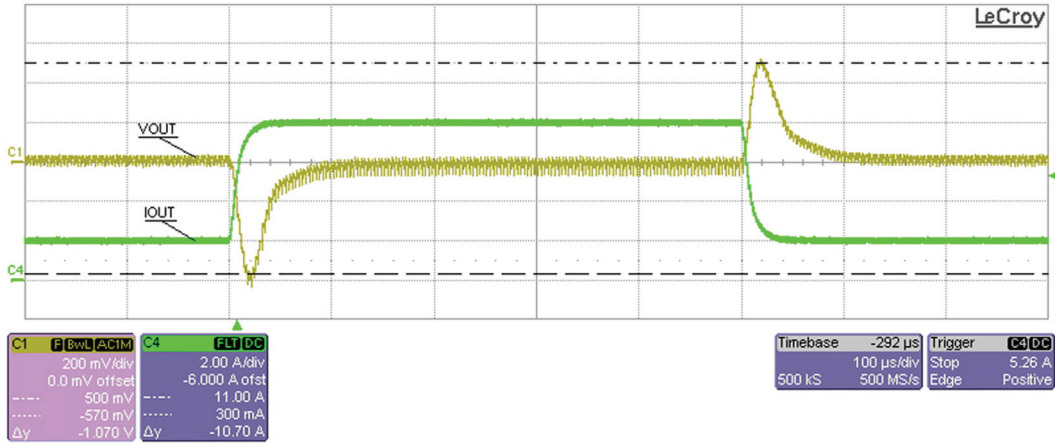

Figure 4. DC1619A 2A to 8A Load Transient

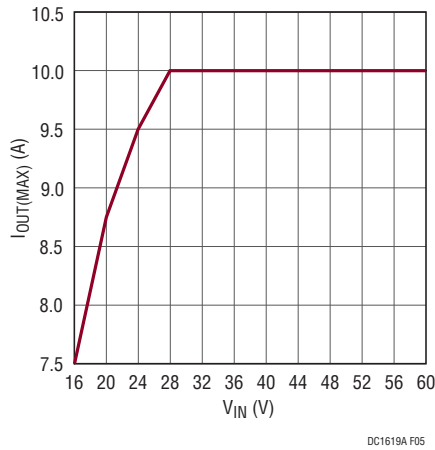

Figure 5. DC1619A Output Current Derating Graph

PARTS LIST

ITEM	QTY	REFERENCE	PART DESCRIPTION	MANUFACTURER/PART NUMBER
Required Circuit Components				
1	2	CIN1, CIN2	CAP, SMT Aluminum, 33µF, 63V	SUNCON, 63HVH33M
2	2	CIN3, CIN4	CAP, X7R, 2.2µF, 100V, 10%, 1210	MURATA, GRM32ER72A225KA35L
3	1	COUT1	CAP, POSCAP, 68µF, 16V, 20%,	SANYO, 16TQC68M
4	1	COUT3	CAP, X5R, 22µF, 16V, 10%, 1210	TAIYO, EMK325BJ226KM-T
5	1	C1	CAP, X5R, 0.47µF, 100V, 10%, 1206	TDK, C3216X5R2A474KAT
6	2	C2, C5	CAP, X7R, 1500pF, 50V, 10%, 0402	AVX, 04025C152KAT
7	1	C4	CAP, COG, 100pF, 50V, 10%, 0402	TDK, C1005COG1H101J
8	1	C6	CAP, X5R, 0.1µF, 16V, 10%, 0402	AVX, 0402YD104KAT
9	1	C7	CAP, X5R, 1µF, 16V, 10%, 0603	TDK, C1608X5R1C105K
10	1	C9	CAP, COG, 220pF, 100V, 10%, 1206	VISHAY, VJ1206A221XB
11	1	D1	HIGH VOLTAGE SWITCHING DIODE, SOD-523	PHILLIPS, BAS521
12	1	D2	SMT SCHOTTKY BARRIER RECTIFIER, SMB	DIODES INC, B160-13-F
13	1	D3	HIGH VOLTAGE SWITCHING DIODE, SOD-323	DIODES INC, 1N4148WS-7-F
14	1	L1	INDUCTOR, 10µH	WURTH ELEKTRONIC, 74435561100
15	2	Q1, Q2	N-MOSFET, 80V	INFINEON, BSC123N08NS3
16	1	R1	RES., CHIP, 1M, 1/16W, 1%, 0402	VISHAY, CRCW04021M00FKED
17	1	R2	RES., CHIP, 97.6k, 1/16W, 1%, 0402	VISHAY, CRW040297K6FKED
18	1	R4	RES., CHIP, 143k, 1/16W, 1%, 0402	VISHAY, CRCW0402143KFKED
19	1	R5	RES., CHIP, 16.2k, 1/16W, 1%, 0402	VISHAY, CRCW040216K2FKED
20	1	R7	RES., CHIP, 20k, 1/16W, 1%, 0402	VISHAY, CRCW040220K0FKED
21	1	R9	RES., CHIP, 49.9k, 1/16W, 1%, 0402	VISHAY, CRCW040249K9FKED
22	1	R10	RES., CHIP, 4.99Ω, 1/16W, 1%, 0402	VISHAY, CRCW04024R99FKED
23	1	R16	RES., CHIP, 6.65Ω, 1/4W, 1%, 1206	VISHAY, CRCW12066R65FKED
24	1	R17	RES., CHIP, 0.007Ω, 1W, 1%, 2512	VISHAY, WSL25127L000FEA
25	1	U1	I.C, LT3845AEFE#PBF, TSSOP (4.4MM) 16-PIN	LINEAR TECH., LT3845AEFE#PBF
Additional Demo Board Circuit Components				
1	0	COUT2 (OPT)	CAP, POSCAP, 68µF, 16V, 20%,	SANYO, 16TQC68M
2	0	COUT4 (OPT)	CAP, X5R, 22µF, 16V, 10%, 1210	AVX, 1210YD226KAT
3	0	C3, C8, C10-C13 (OPT)	CAP, 0402	
4	0	D4, D5 (OPT)	DUAL SMT SWITCHING DIODE, SOT-23	DIODES INC, BAV99-7-F
5	1	R3	RES., CHIP, 5.1M, 1/16W, 5%, 0402	PANASONIC, ERJ2GEJ515X
6	5	R11-R15	RES., CHIP, 0Ω, 1/16W, 0402	VISHAY, CRCW04020000Z0ED
7	1	R8	RES., CHIP, 100k, 1/16W, 1%, 0402	VISHAY, CRCW0402100KFKED
8	0	Q4, Q5 (OPT)	N-MOSFET, 80V	INFINEON, BSC123N08NS3
9	0	Q3 (OPT)	COMPLIMENARY MOSFET PAIR, SC-70	VISHAY, Si1555DL-T1-E3
10	0	R6, R18-R22 (OPT)	RES., 0402	
Hardware For Demo Board Only				
1	4	J1-J4	JACK, BANANA	KEYSTONE, 575-4
2	5	E1-E5	TESTPOINT, TURRET, 0.095"	MILL-MAX, 2501-2-00-80-00-00-07-0
3	1	JP1	JMP, 3-PIN 1 ROW 0.079CC	SAMTEC, TMM-103-02-L-S
4	1	JP2	2MM DOUBLE ROW HEADER 2x3	SAMTEC, TMM-103-02-L-D
5	2	JP1(1 and 2), JP2 (5 and 6)	SHUNT, 0.079" CENTER	SAMTEC, 2SN-BK-G
6	4	STAND-OFF	STAND-OFF, NYLON 0.50" tall	KEYSTONE, 8833(SNAP ON)

DEMO MANUAL DC1619A

SCHEMATIC DIAGRAM

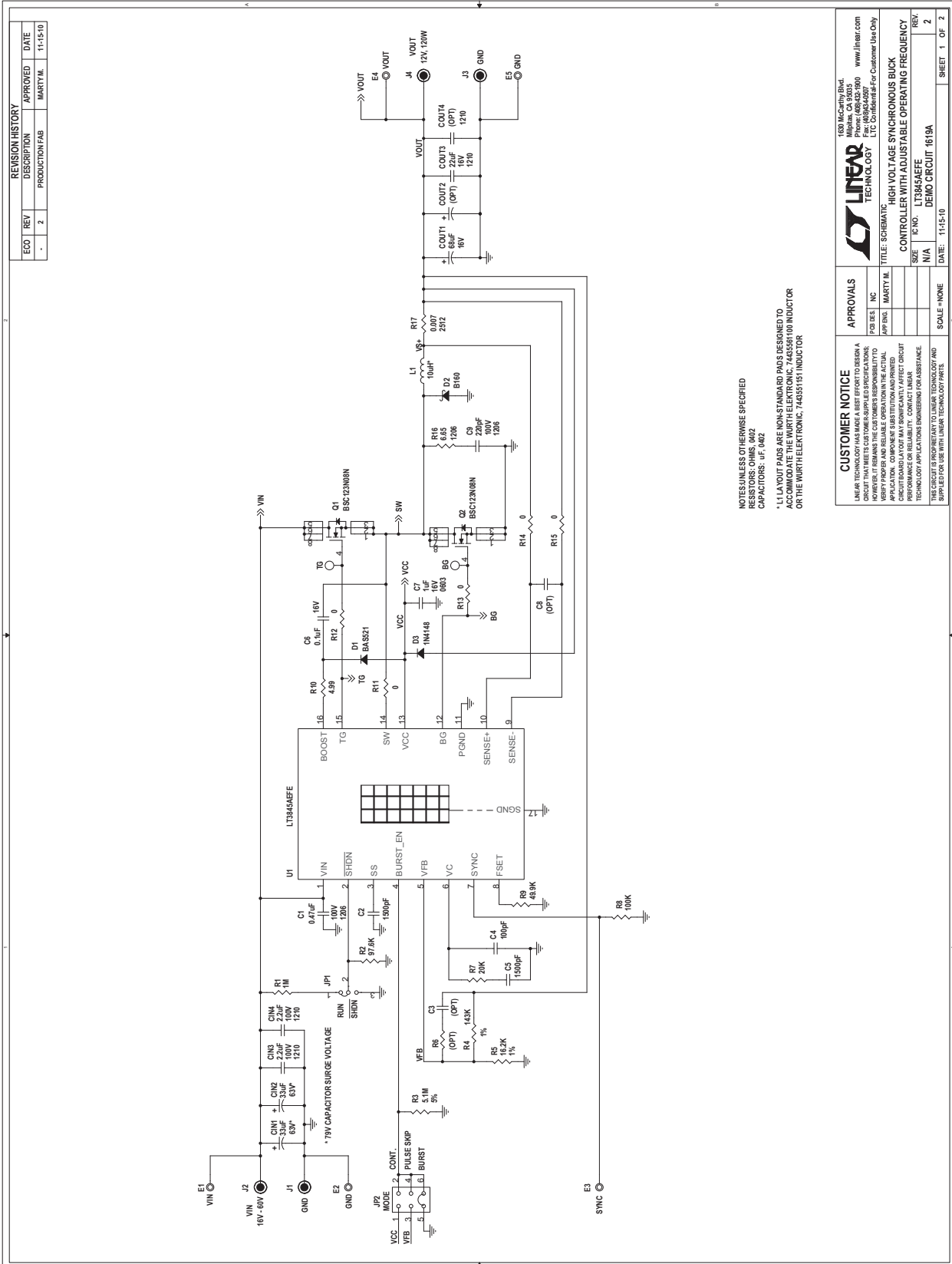

REVISION HISTORY			
ECO	REV	DESCRIPTION	APPROVED
.	2	PRODUCTION FAB	MARTY M.
			DATE
			11-15-10

NOTES UNLESS OTHERWISE SPECIFIED:
 1. ALL VOLTAGE PAIDS ARE NON-STANDARD PAIDS DESIGNED TO
 MATCH THE PARTS LISTED IN THE PARTS LIST.
 CAPACITORS: μF, μ02
 * L1 LAYOUT PAIDS ARE NON-STANDARD PAIDS DESIGNED TO
 MATCH THE PARTS LISTED IN THE PARTS LIST.
 OR THE WURTELEKTRONIK, 74655151 INDUCTOR

CUSTOMER NOTICE
 LINEAR TECHNOLOGY HAS MADE A BEST EFFORT TO DESIGN A
 CIRCUIT THAT MEETS CUSTOMER-SUPPLIED SPECIFICATIONS.
 CUSTOMER SPECIFICATIONS MAY VARY FROM THE ACTUAL
 PARTS AND COMPONENTS USED IN THE ACTUAL
 APPLICATION. COMPONENT SUBSTITUTION AND PRINTED
 CIRCUIT BOARD MANUFACTURING VARIATIONS MAY AFFECT CIRCUIT
 PERFORMANCE AND RELIABILITY. CONTACT YOUR
 TECHNOLOGY APPLICATIONS ENGINEERING FOR ASSISTANCE.
 THIS CIRCUIT IS PROPRIETARY TO LINEAR TECHNOLOGY AND
 SUPPLIED FOR USE WITH LINEAR TECHNOLOGY PARTS.

APPROVALS

DESIGN	NC
TESTING	MARTY M.

LINEAR TECHNOLOGY
 1650 McCarthy Blvd.
 Fremont, CA 94538-5000
 Phone: (609)432-1900
 Fax: (609)432-0900
 E-Mail: custhelp@linear.com
 L.T.C. Solutions for Customer Use Only

LINEAR TECHNOLOGY
 HIGH VOLTAGE SYNCHRONOUS BUCK
 CONTROLLER WITH ADJUSTABLE OPERATING FREQUENCY
 DEMO CIRCUIT 1619A

SCALE: NONE

DATE: 11-15-10

SHEET 1 OF 2

SCHEMATIC DIAGRAM

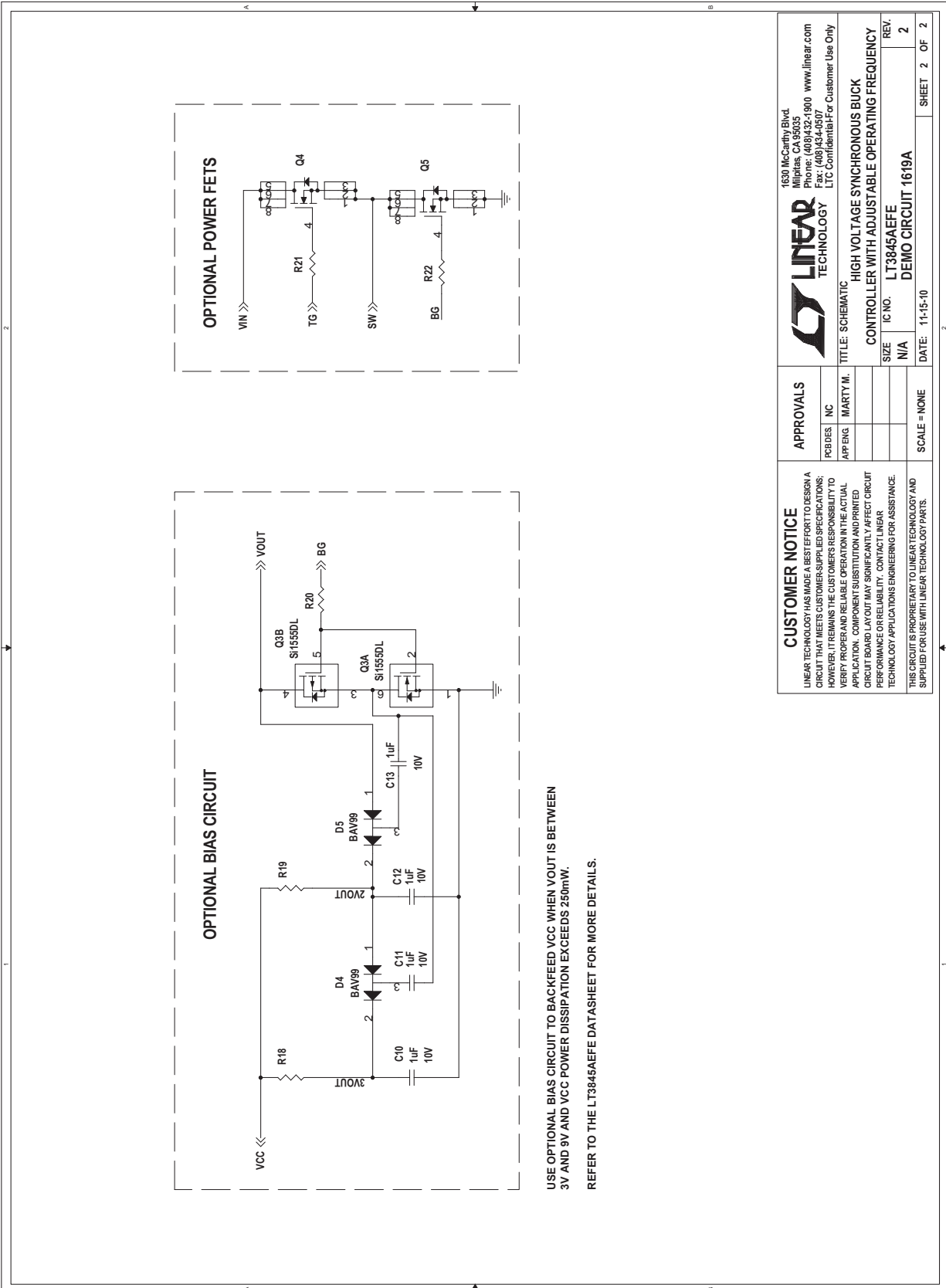

CUSTOMER NOTICE		APPROVALS	
LINEAR TECHNOLOGY HAS MADE A BEST EFFORT TO DESIGN A CIRCUIT THAT MEETS CUSTOMER-SUPPLIED SPECIFICATIONS; HOWEVER, IT REMAINS THE CUSTOMER'S RESPONSIBILITY TO REEVALUATE THE DESIGN FOR APPLICATION AND PRACTICAL APPLICATIONS. COMPONENT SUBSTITUTION AND PHYSICAL CIRCUIT BOARD LAYOUT MAY SIGNIFICANTLY AFFECT CIRCUIT PERFORMANCE OR RELIABILITY. CONTACT LINEAR TECHNOLOGY APPLICATIONS ENGINEERING FOR ASSISTANCE.		DESIGNER: NC	DATE: 11-15-10
THIS CIRCUIT IS PROPRIETARY TO LINEAR TECHNOLOGY AND SUPPLIED FOR USE WITH LINEAR TECHNOLOGY PARTS.		APP'G: MARTY.M.	SCALE = NONE
		PCB DES: NC	SHEET 2 OF 2
		TITLE: SCHEMATIC	
		HIGH VOLTAGE SYNCHRONOUS BUCK CONTROLLER WITH ADJUSTABLE OPERATING FREQUENCY	
SIZE	IC NO.	REV.	
N/A	LT3845AEFF	2	
DEMO CIRCUIT 1619A			

1630 McCarthy Blvd.
 Milpitas, CA 95035
 Phone: (408)432-1900 www.linear.com
 Fax: (408)432-1999
 E-mail: info@linear.com
 LTC Confidential For Customer Use Only

DEMO MANUAL DC1619A

DEMONSTRATION BOARD IMPORTANT NOTICE

Linear Technology Corporation (LTC) provides the enclosed product(s) under the following **AS IS** conditions:

This demonstration board (DEMO BOARD) kit being sold or provided by Linear Technology is intended for use for **ENGINEERING DEVELOPMENT OR EVALUATION PURPOSES ONLY** and is not provided by LTC for commercial use. As such, the DEMO BOARD herein may not be complete in terms of required design-, marketing-, and/or manufacturing-related protective considerations, including but not limited to product safety measures typically found in finished commercial goods. As a prototype, this product does not fall within the scope of the European Union directive on electromagnetic compatibility and therefore may or may not meet the technical requirements of the directive, or other regulations.

If this evaluation kit does not meet the specifications recited in the DEMO BOARD manual the kit may be returned within 30 days from the date of delivery for a full refund. **THE FOREGOING WARRANTY IS THE EXCLUSIVE WARRANTY MADE BY THE SELLER TO BUYER AND IS IN LIEU OF ALL OTHER WARRANTIES, EXPRESSED, IMPLIED, OR STATUTORY, INCLUDING ANY WARRANTY OF MERCHANTABILITY OR FITNESS FOR ANY PARTICULAR PURPOSE. EXCEPT TO THE EXTENT OF THIS INDEMNITY, NEITHER PARTY SHALL BE LIABLE TO THE OTHER FOR ANY INDIRECT, SPECIAL, INCIDENTAL, OR CONSEQUENTIAL DAMAGES.**

The user assumes all responsibility and liability for proper and safe handling of the goods. Further, the user releases LTC from all claims arising from the handling or use of the goods. Due to the open construction of the product, it is the user's responsibility to take any and all appropriate precautions with regard to electrostatic discharge. Also be aware that the products herein may not be regulatory compliant or agency certified (FCC, UL, CE, etc.).

No License is granted under any patent right or other intellectual property whatsoever. **LTC assumes no liability for applications assistance, customer product design, software performance, or infringement of patents or any other intellectual property rights of any kind.**

LTC currently services a variety of customers for products around the world, and therefore this transaction **is not exclusive**.

Please read the DEMO BOARD manual prior to handling the product. Persons handling this product must have electronics training and observe good laboratory practice standards. **Common sense is encouraged.**

This notice contains important safety information about temperatures and voltages. For further safety concerns, please contact a LTC application engineer.

Mailing Address:

Linear Technology
1630 McCarthy Blvd.
Milpitas, CA 95035

Copyright © 2004, Linear Technology Corporation

Компания «Океан Электроники» предлагает заключение долгосрочных отношений при поставках импортных электронных компонентов на взаимовыгодных условиях!

Наши преимущества:

- Поставка оригинальных импортных электронных компонентов напрямую с производств Америки, Европы и Азии, а так же с крупнейших складов мира;
- Широкая линейка поставок активных и пассивных импортных электронных компонентов (более 30 млн. наименований);
- Поставка сложных, дефицитных, либо снятых с производства позиций;
- Оперативные сроки поставки под заказ (от 5 рабочих дней);
- Экспресс доставка в любую точку России;
- Помощь Конструкторского Отдела и консультации квалифицированных инженеров;
- Техническая поддержка проекта, помощь в подборе аналогов, поставка прототипов;
- Поставка электронных компонентов под контролем ВП;
- Система менеджмента качества сертифицирована по Международному стандарту ISO 9001;
- При необходимости вся продукция военного и аэрокосмического назначения проходит испытания и сертификацию в лаборатории (по согласованию с заказчиком);
- Поставка специализированных компонентов военного и аэрокосмического уровня качества (Xilinx, Altera, Analog Devices, Intersil, Interpoint, Microsemi, Actel, Aeroflex, Peregrine, VPT, Syfer, Eurofarad, Texas Instruments, MS Kennedy, Miteq, Cobham, E2V, MA-COM, Hittite, Mini-Circuits, General Dynamics и др.);

Компания «Океан Электроники» является официальным дистрибьютором и эксклюзивным представителем в России одного из крупнейших производителей разъемов военного и аэрокосмического назначения «JONHON», а так же официальным дистрибьютором и эксклюзивным представителем в России производителя высокотехнологичных и надежных решений для передачи СВЧ сигналов «FORSTAR».



JONHON

«JONHON» (основан в 1970 г.)

Разъемы специального, военного и аэрокосмического назначения:

(Применяются в военной, авиационной, аэрокосмической, морской, железнодорожной, горно- и нефтедобывающей отраслях промышленности)

«FORSTAR» (основан в 1998 г.)

ВЧ соединители, коаксиальные кабели, кабельные сборки и микроволновые компоненты:

(Применяются в телекоммуникациях гражданского и специального назначения, в средствах связи, РЛС, а так же военной, авиационной и аэрокосмической отраслях промышленности).



Телефон: 8 (812) 309-75-97 (многоканальный)

Факс: 8 (812) 320-03-32

Электронная почта: ocean@oceanchips.ru

Web: <http://oceanchips.ru/>

Адрес: 198099, г. Санкт-Петербург, ул. Калинина, д. 2, корп. 4, лит. А