

GENERAL DESCRIPTION

The XRP29300/01/02 are 3A, highly accurate voltage regulators with a low dropout voltage of 600mV (typical) at 3A.

These regulators are specifically designed for low voltage applications that require a low dropout voltage and a fast transient response. They are fully fault protected against over-current, reverse battery, and positive and negative voltage transients. On-Chip trimming adjusts the reference voltage to 1% initial accuracy.

The XRP29300 is offered in a 3-pin TO-263 package, the XRP29301 is offered in a 5-pin TO-263 while XRP29302 is offered in a 5-pin TO-263 and 5-pin TO-220 packages.

APPLICATIONS

- Adjustable Power Supplies
- Constant Current Regulators
- Audio and Video/Graphic Cards
- Battery Chargers

FEATURES

- 3A Guaranteed Output Current
- Low Dropout Voltage of 600mV @ 3A
- Adjustable Output down to 1.25V
- 1% Output Accuracy
- Tight Load and Line Regulation
- Fast Transient Response
- Reverse Battery Protection
- Zero Current Shutdown (XRP29301/02)
- Power Good Flag (XRP29301)
- Lead Free 3-Pin TO-263, 5-pin TO-220 and TO-263 Packages

TYPICAL APPLICATION DIAGRAM

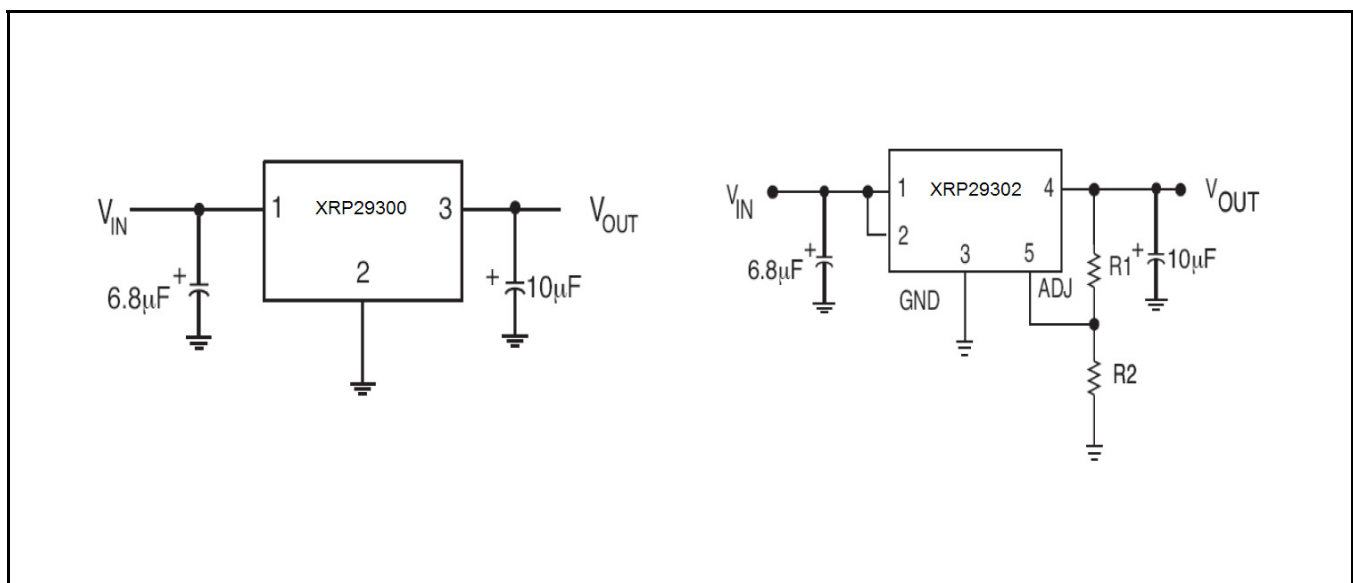

Fig. 1: XRP29300 and XRP29302 Application Diagrams



ABSOLUTE MAXIMUM RATINGS

These are stress ratings only and functional operation of the device at these ratings or any other above those indicated in the operation sections of the specifications below is not implied. Exposure to absolute maximum rating conditions for extended periods of time may affect reliability.

Input Voltage V_{IN}^1	20V
Storage Temperature	-65°C to 150°C
Lead Temperature (Soldering, 5 sec)	260°C
ESD Rating (HBM - Human Body Model)	
All pins except EN	2kV
En pin	1kV

OPERATING RATINGS

Input Voltage Range V_{IN}	16V
Junction Temperature Range	-40°C to 125°C
Thermal Resistance	
TO-220-5 Junction to Ambient	29.3°C/W
TO-263-3 Junction to Ambient	31.4°C/W
TO-263-5 Junction to Ambient	31.2°C/W
TO-220-5, TO-263-3, TO-263-5 Junction to Case ..	3°C/W

Note 1: Maximum positive supply voltage of 20V must be of limited duration (<100ms) and duty cycle of less than 1%. The maximum continuous supply voltage is 16V.

ELECTRICAL SPECIFICATIONS

Specifications with standard type are for an Operating Junction Temperature of $T_J = T_A = 25^\circ\text{C}$ only; limits applying over the full Operating Junction Temperature range are denoted by a “•”. Minimum and Maximum limits are guaranteed through test, design, or statistical correlation. Typical values represent the most likely parametric norm at $T_J = 25^\circ\text{C}$, and are provided for reference purposes only. Unless otherwise indicated, $V_{IN} = V_{OUT} + 1\text{V}$ and $I_{OUT} = 10\text{mA}$, $C_{IN} = 6.8\mu\text{F}$, $C_{OUT} = 10\mu\text{F}$, $T_A = 25^\circ\text{C}$.

Parameter	Min.	Typ.	Max.	Units	Conditions
Fixed Voltage Versions					
Output Voltage, 1.8V Version	1.782	1.800	1.818	V	$I_{OUT} = 10\text{mA}$
	1.764	1.800	1.836		• $10\text{mA} \leq I_{OUT} \leq 3\text{A}$, $2.8\text{V} \leq V_{IN} \leq 16\text{V}$
Output Voltage, 2.5V Version	2.475	2.500	2.525	V	$I_{OUT} = 10\text{mA}$
	2.450	2.500	2.550		• $10\text{mA} \leq I_{OUT} \leq 3\text{A}$, $3.5\text{V} \leq V_{IN} \leq 16\text{V}$
Output Voltage, 3.3V Version	3.267	3.300	3.333	V	$I_{OUT} = 10\text{mA}$
	3.234	3.300	3.366		• $10\text{mA} \leq I_{OUT} \leq 3\text{A}$, $4.3\text{V} \leq V_{IN} \leq 16\text{V}$
Output Voltage, 5.0V Version	4.950	5.000	5.050	V	$I_{OUT} = 10\text{mA}$
	4.900	5.000	5.100		• $10\text{mA} \leq I_{OUT} \leq 3\text{A}$, $6.0\text{V} \leq V_{IN} \leq 16\text{V}$
All Voltage Versions					
Line Regulation		0.06	0.5	%	$I_{OUT} = 10\text{mA}$, $(V_{OUT} + 1\text{V}) \leq V_{IN} \leq 16\text{V}$
Load Regulation		0.2	1	%	$V_{IN} = V_{OUT} + 1\text{V}$, $10\text{mA} \leq I_{OUT} \leq I_{FL}$ (note 2)
$\Delta V/\Delta T$		20	100	ppm/°C	• V_{OUT} Temp Coefficient (note 6)
Dropout Voltage Except 1.8V Version (note 3)		120	300	mV	• $I_{OUT} = 100\text{mA}$
		380			$I_{OUT} = 1.5\text{A}$
		600	800		• $I_{OUT} = 3\text{A}$
Ground Current (note 5)		30	60	mA	• $I_{OUT} = 1.5\text{A}$
		40			$I_{OUT} = 3\text{A}$
Ground Pin Current at Dropout		0.9		mA	$V_{IN} = 0.5\text{V}$ less than specified V_{OUT} $I_{OUT} = 10\text{mA}$
Current Limit	3.0	4.5		A	$V_{OUT} = 0\text{V}$ (note 4)
Output Noise Voltage		400		μV_{RMS}	10Hz-100KHz, $I_{OUT} = 100\text{mA}$, $C_{OUT} = 10\mu\text{F}$
		260			10Hz-100KHz, $I_{OUT} = 100\text{mA}$, $C_{OUT} = 33\mu\text{F}$
Reference Voltage Temperature Coefficient		20		ppm/°C	Note 7
Reference Voltage and Adjustable Pin - XRP29302					
Reference Voltage	1.228	1.24	1.252	V	• $V_{REF} \leq V_{OUT} \leq (V_{IN} - 1)$, $2.3\text{V} \leq V_{IN} \leq 16\text{V}$ $10\text{mA} \leq I_L \leq I_{FL}$, $T_J < T_{JMAX}$
	1.215		1.265		
	1.203		1.277		
Adjust Pin Bias Current		40	80	nA	•
			120		
Adjust Pin Bias Current Temperature Coefficient		0.1		nA/°C	

Parameter	Min.	Typ.	Max.	Units	Conditions
Power Good Flag Output – XRP29301					
Output Leakage Current		0.01	1	μA	• V _{OH} =16V
			2		
Output Low Voltage		220	300	mV	• Device set for 5V, V _{IN} =4.5V, I _{OL} =250μA
			400		
Upper Threshold Voltage	40	60		mV	• Device set for 5V, Note 8
	25				
Lower Threshold Voltage		75	95	mV	• Device set for 5V, Note 8
			140		
Hysteresis		15		mV	• Device set for 5V, Note 8
Enable Input – XRP29301/02					
Input Logic Voltage Low (OFF)			0.8	V	• V _{IN} <10V
Input Logic Voltage High (ON)	2.4				
Enable Input Pin		100	600	μA	• V _{EN} =16V
			750		
			1		
			2		
Regulator Output Current in Shutdown		10	500	μA	• Note 9

Note 2: Full load current (I_{FL}) is defined as 3.0A.

Note 3: Dropout voltage is defined (V_{IN}-V_{OUT}) when the output voltage drops to 99% of its nominal value.

Note 4: V_{IN}=V_{OUT}(nom)+1V. Use pulse-testing procedures to minimize temperature rise.

Note 5: Ground pin current is the regulator quiescent current. The total current drawn from the source is the sum of the load current to the ground current.

Note 6: Output voltage temperature coefficient is defined as the worst case voltage change divided by the total temperature range

Note 7: Thermal regulation is defined as the change in output voltage at time T after a change in power dissipation is applied, excluding load/line regulation effects. Specifications for a 200mA load pulse as V_{IN}=20V (a 4W pulse) for t=10ms.

Note 8: Comparator threshold is expressed in terms of a voltage differential at the Adjust terminal below the nominal reference voltage measured 6V input. To express these thresholds in terms of output voltage change, multiply the error amplifier gain = V_{OUT}/V_{REF} = (R1 + R2)/R2. For example, at a programmable output voltage of 5V, the Error output is guaranteed to go low when the output drops by 95mVx 5V/ 1.240V = 383mV. Threshold remain constant as a percent of V_{OUT} as V_{OUT} is varied, with the dropout warning occurring at typically 5% below nominal, 7.7% guaranteed.

Note 9: V_{EN} ≤ 0.8V and V_{IN} ≤ 16V, V_{OUT} = 0.

BLOCK DIAGRAM

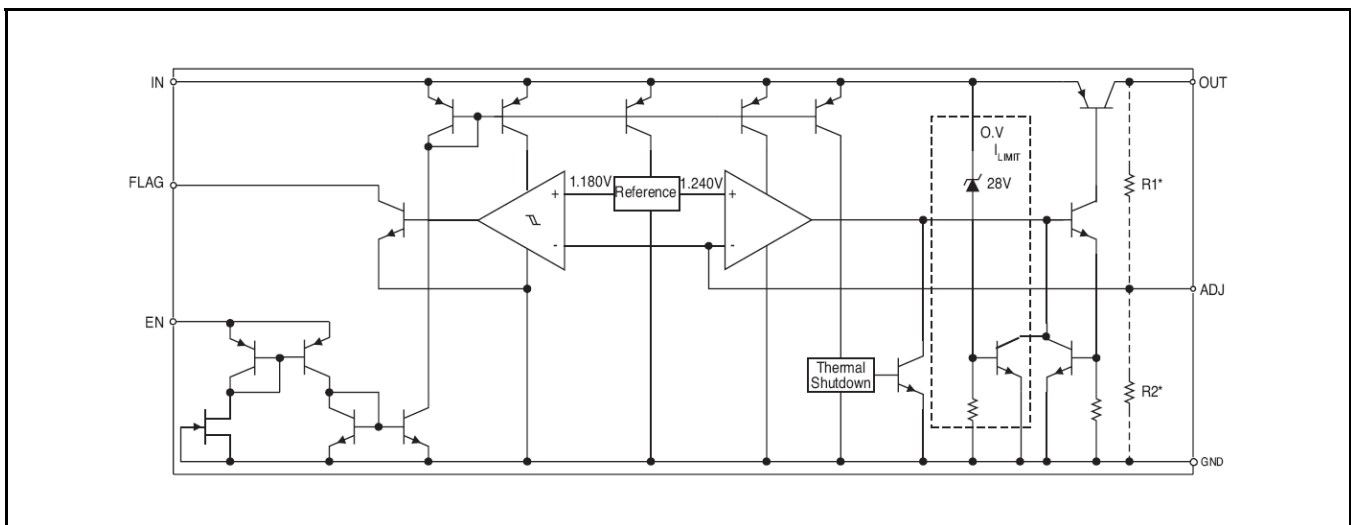

Fig. 2: XRP29300/01/02 Block Diagram

PIN ASSIGNMENT

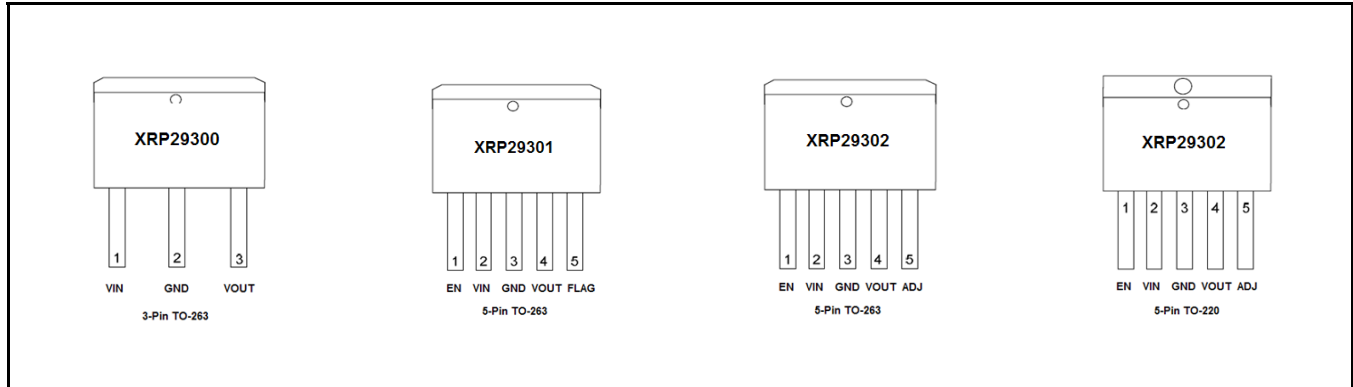

Fig. 3: XRP29300/01/02 Pin Assignment

ORDERING INFORMATION

Part Number	Junction Temperature Range	Marking	Package	Packing Quantity	Note 1	Note 2
XRP29300-18ETB3-L	-40°C ≤ T _J ≤ +125°C	29300-18 YYWW XXX	3-pin TO263	Bulk	Lead Free	1.8V
XRP29300-18ETB3TR-L				500/Tape & Reel		
XRP29300-25ETB3-L	-40°C ≤ T _J ≤ +125°C	29300-25 YYWW XXX	3-pin TO263	Bulk	Lead Free	2.5V
XRP29300-25ETB3TR-L				500/Tape & Reel		
XRP29300-33ETB3-L	-40°C ≤ T _J ≤ +125°C	29300-33 YYWW XXX	3-pin TO263	Bulk	Lead Free	3.3V
XRP29300-33ETB3TR-L				500/Tape & Reel		
XRP29300-50ETB3-L	-40°C ≤ T _J ≤ +125°C	29300-500 YYWW XXX	3-pin TO263	Bulk	Lead Free	5.0V
XRP29300-50ETB3TR-L				500/Tape & Reel		
XRP29301-33ETB5-L	-40°C ≤ T _J ≤ +125°C	29301-33 YYWW XXX	5-pin TO263	Bulk	Lead Free	3.3V
XRP29301-33ETB5TR-L				500/Tape & Reel		
XRP29301-50ETB5-L	-40°C ≤ T _J ≤ +125°C	29300-50 YYWW XXX	5-pin TO263	Bulk	Lead Free	5.0V
XRP29301-50ETB5TR-L				500/Tape & Reel		
XRP29302ET-L	-40°C ≤ T _J ≤ +125°C	XRP29302E YYWW X	5-pin TO220	Bulk	Lead Free	Adjustable
XRP29302ETB-L	-40°C ≤ T _J ≤ +125°C	XRP29302E YYWW X	5-pin TO263	Bulk	Lead Free	Adjustable
XRP29302ETBTR-L				500/Tape & Reel		

“YY” = Year - “WW” = Work Week - “L” = Lead Free Designator - “X” = Lot Number when applicable.

TYPICAL PERFORMANCE CHARACTERISTICS

All data taken at $V_{IN} = V_{OUT} + 1V$, $T_J = T_A = 25^\circ C$, unless otherwise specified.

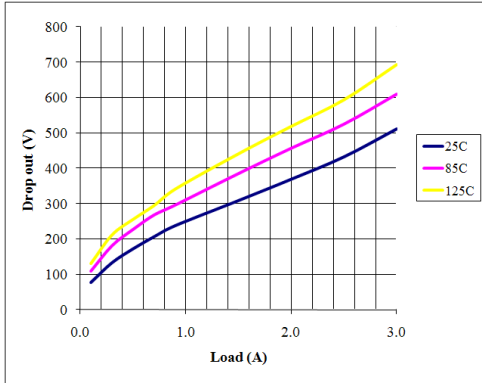

Fig. 4: Dropout Voltage vs Load Current

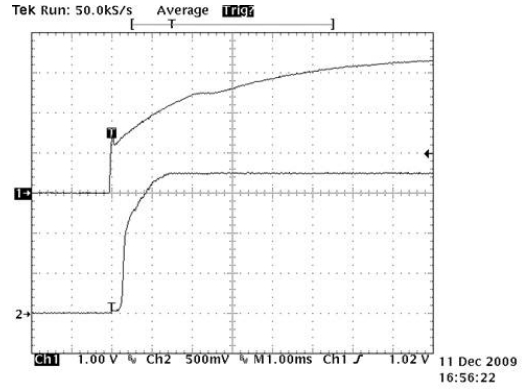

Fig. 5: Startup

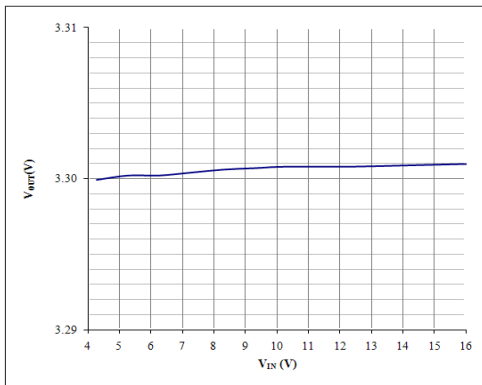

Fig. 6: Line Regulation
 $I_{OUT}=10mA$, $V_{OUT}=3.3V$

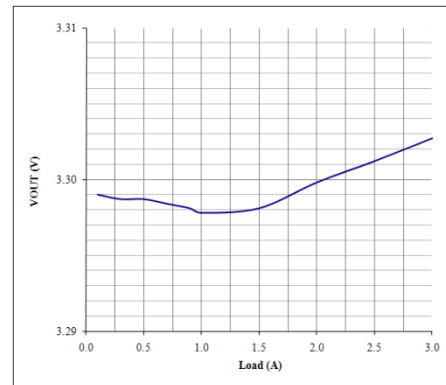

Fig. 7: Load Regulation
 $V_{IN}=4.3V$, $V_{OUT}=3.3V$



THEORY OF OPERATION

The XRP29300/01/02 incorporates protection against over-current faults, reversed load insertion, over temperature operation, and positive and negative transient voltage.

THERMAL CONSIDERATIONS

Although the XRP29300/01/02 offers limiting circuitry for overload conditions, it is still necessary to insure that the maximum junction temperature is not exceeded in the application. Heat will flow through the lowest resistance path, the junction-to-case path. In order to insure the best thermal flow of the component, proper mounting is required.

TO-220 DESIGN EXAMPLE:

Assume that $V_{IN} = 10V$, $V_{OUT} = 5V$, $I_{OUT} = 1.5A$, $T_A = 50^{\circ}C$, $\theta_{HA} = 1^{\circ}C/W$, $\theta_{CH} = 2^{\circ}C/W$, and $\theta_{JC} = 3^{\circ}C/W$, where:

T_A = ambient temperature,

θ_{HA} = heatsink to ambient thermal resistance

θ_{CH} = case to heatsink thermal resistance

θ_{JC} = junction to case thermal resistance

The power calculated under these conditions is:

$$P_D = (V_{IN} - V_{OUT}) \times I_{OUT} = 7.5W$$

And the junction temperature is calculated as

$$T_J = T_A + P_D \times (\theta_{HA} + \theta_{CH} + \theta_{JC})$$

or

$$T_J = 50 + 7.5 \times (1 + 2 + 3) = 95^{\circ}C$$

Reliable operation is insured. Capacitor Requirements

CAPACITOR REQUIREMENTS

The output capacitor is needed to insure stability and minimize the output noise. The value of the capacitor varies with the load. However, a minimum value of 10µF aluminum

capacitor will guarantee stability over all load conditions.

A tantalum capacitor is recommended if a faster load transient response is needed. If the power source has high AC impedance, a 0.1µF ceramic capacitor between input & ground is recommended.

MINIMUM LOAD CURRENT

To ensure a proper behavior of the regulator under light load, a minimum load of 5mA for XRP29300/01/02 is required.

ADJUSTABLE REGULATOR DESIGN

The XRP29300/01/02 is an adjustable regulator that can be programmed to any value between 1.25V and 16V using 2 external resistors, R1 and R2. The relationship between the resistors and the output voltage is:

$$R_1 = R_2 \times \left(\frac{V_{OUT}}{1.240 - 1} \right)$$

ERROR FLAG

The XRP29301 features an error flag that indicates either an over current or under current voltage condition. The flag output goes low, sinking 10mA when either conditions occurs.

ENABLE INPUT

The XRP29301/02 has an Enable function that switches the regulator on and off. Their thresholds are TTL compatible. When the regulator is active, approximately 20µA flows through the Enable pin.

TYPICAL APPLICATION CIRCUITS

Figure 1 represents the typical implementation for an adjustable output regulator. The values of R1 and R2 set the output voltage value as follows:

$$V_{OUT} = V_{REF} \times \left(1 + \frac{R_1}{R_2} \right)$$

A minimum value of 10kohms is recommended for R2 with a range between 10kΩ and 47kΩ.

PACKAGE SPECIFICATION

3-PIN TO-263

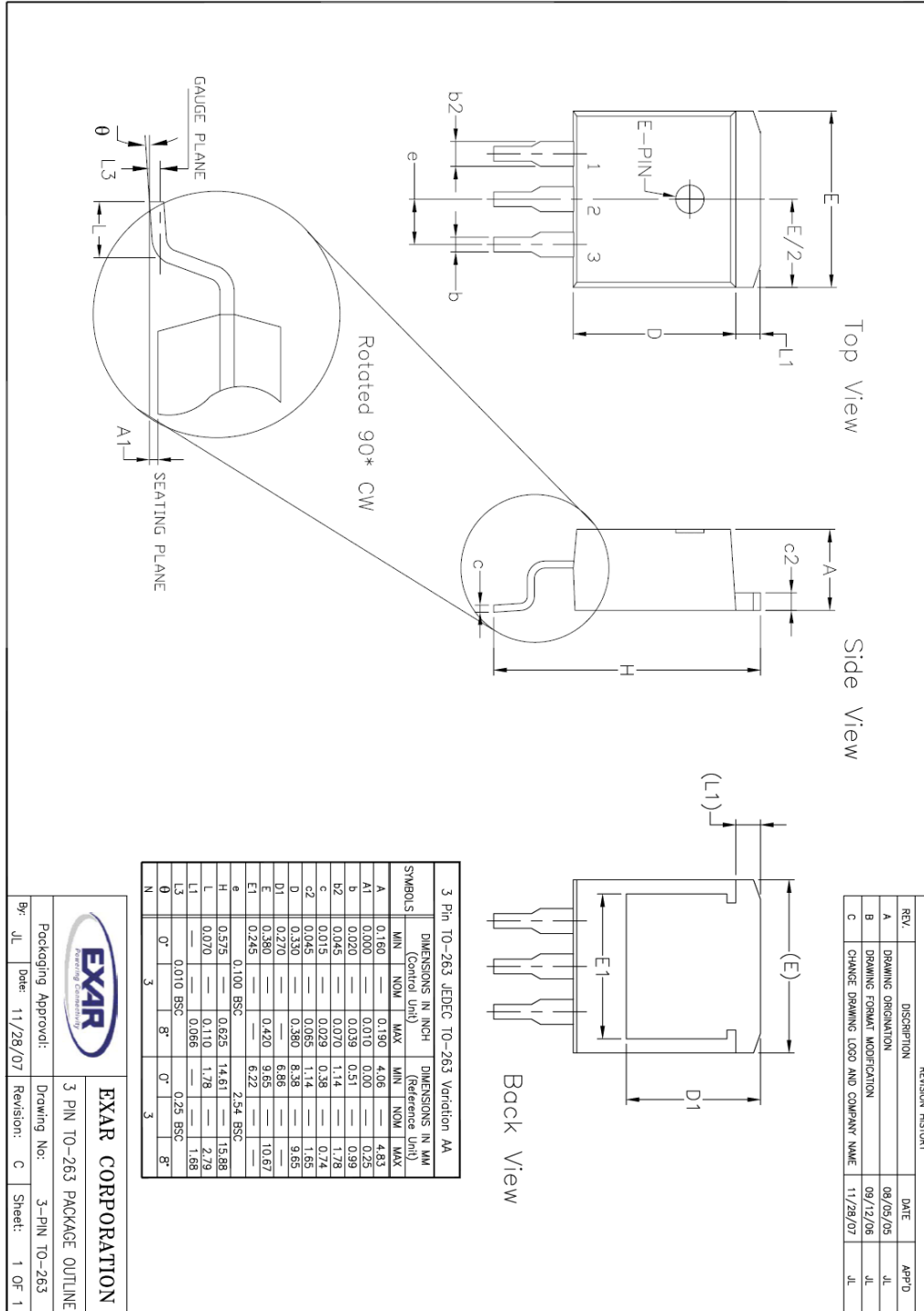

5-PIN TO-263

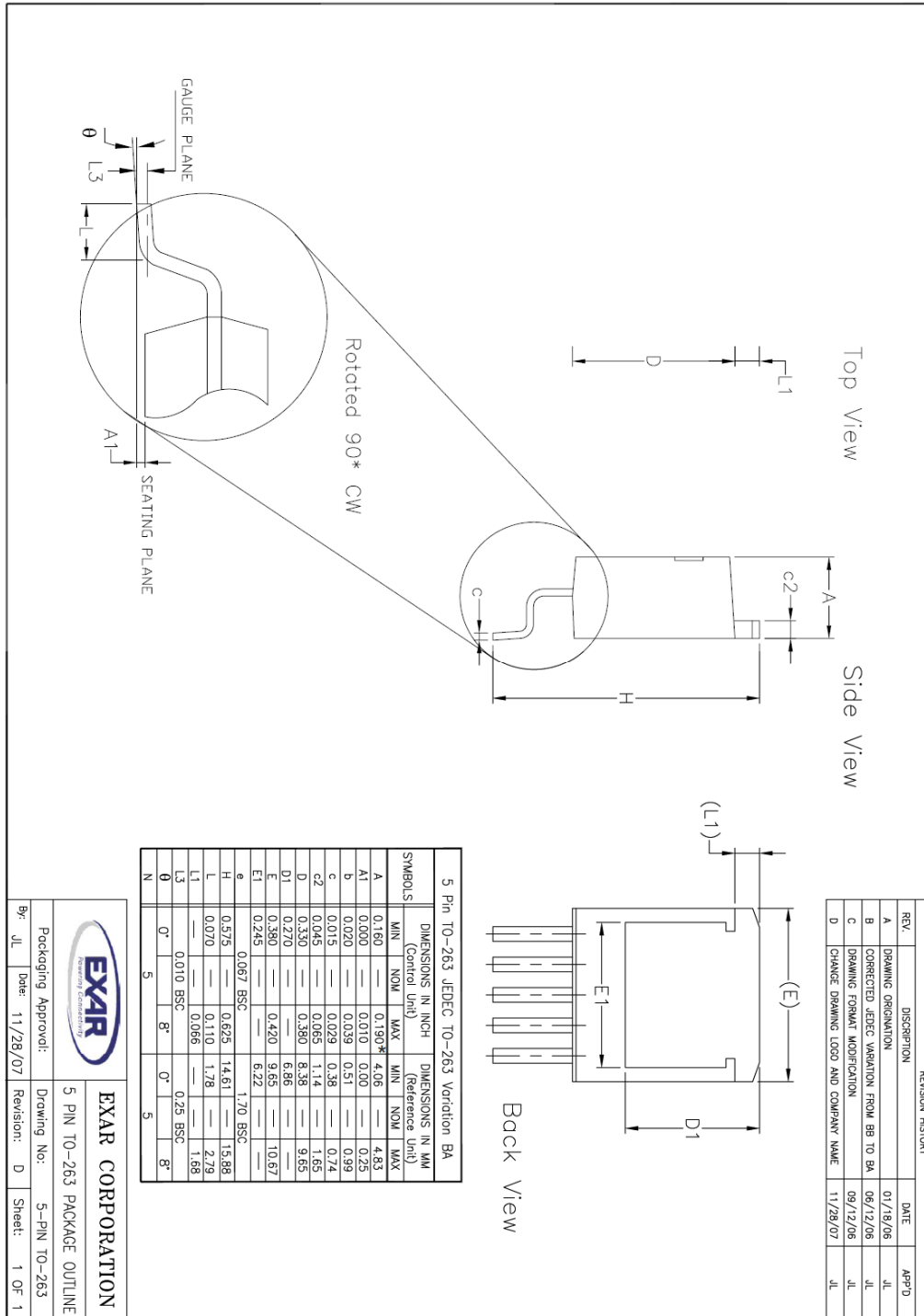

REVISION HISTORY			
REV.	DISPOSITION	DATE	APP'D
A	DRAWING ORIGINATOR	01/18/06	JL
B	CORRECTED JEDEC VARIATION FROM BA TO BA	06/12/06	JL
C	DRAWING FORMAT MODIFICATION	09/12/06	JL
D	CHANGE DRAWING LOGO AND COMPANY NAME	11/28/07	JL

By: JL Date: 11/28/07

Packaging Approval: _____

EXAR CORPORATION

5 PIN TO-263 PACKAGE OUTLINE

Drawing No: 5-PIN TO-263

Revision: D Sheet: 1 OF 1

5-PIN TO-220

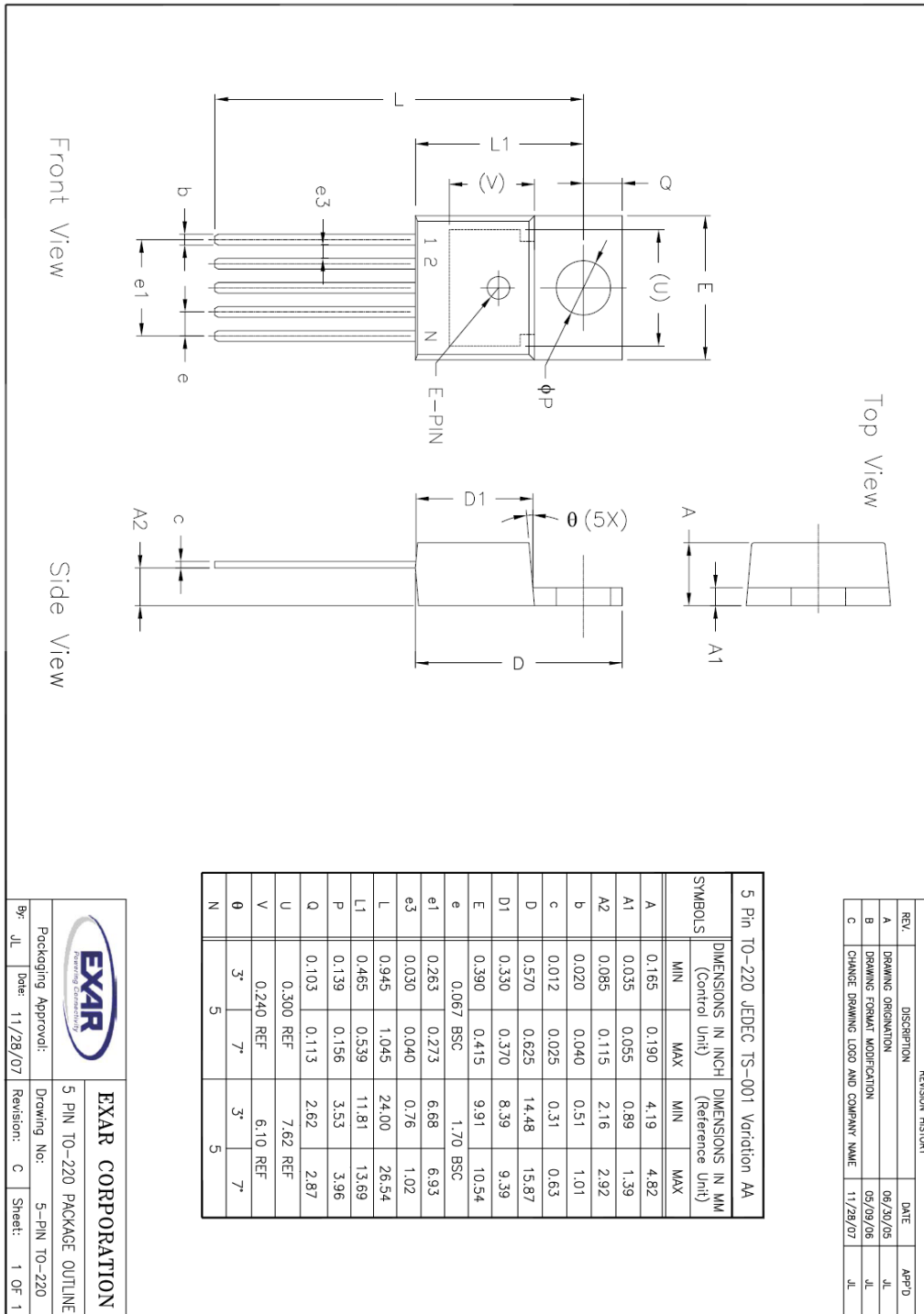

REVISION HISTORY			
REV.	DESCRIPTION	DATE	APP'D
A	DRAWING ORIGINATOR	06/20/05	JL
B	DRAWING FORMAT MODIFICATION	05/09/06	JL
C	CHANGE DRAWING LOGO AND COMPANY NAME	11/28/07	JL

5 Pin TO-220 JEDEC TS-001 Variation AA					
SYMBOLS	DIMENSIONS IN INCH (Control Unit)		DIMENSIONS IN MM (Reference Unit)		
	MIN	MAX	MIN	MAX	
A	0.165	0.190	4.19	4.82	
A1	0.035	0.055	0.89	1.39	
A2	0.085	0.115	2.16	2.92	
b	0.020	0.040	0.51	1.01	
c	0.012	0.025	0.31	0.63	
D	0.570	0.625	14.48	15.87	
D1	0.350	0.370	8.39	9.39	
E	0.390	0.415	9.91	10.54	
e	0.067	BSC	1.70	BSC	
e1	0.263	0.273	6.68	6.93	
e3	0.030	0.040	0.76	1.02	
L	0.945	1.045	24.00	26.54	
L1	0.465	0.539	11.81	13.69	
P	0.139	0.156	3.53	3.96	
Q	0.103	0.113	2.62	2.87	
U	0.300	REF	7.62	REF	
V	0.240	REF	6.10	REF	
θ	3°	7°	3°	7°	
N	5	5	5	5	

		EXAR CORPORATION	
Packaging Approval:		5 PIN TO-220 PACKAGE OUTLINE	
By: JL	Date: 11/28/07	Drawing No:	5-PIN TO-220
		Revision:	C
		Sheet:	1 OF 1



XRP29300/01/02

3A Low Dropout Voltage Regulator

REVISION HISTORY

Revision	Date	Description
1.0.0	12/17/2009	Initial Release of Datasheet
1.1.0	12/23/2009	Addition of ESD Data
2.1.0	05/05/2011	Addition of XRP29300 and XRP29301 data

FOR FURTHER ASSISTANCE

Email:

customersupport@exar.com

Exar Technical Documentation:

<http://www.exar.com/TechDoc/default.aspx?>

EXAR CORPORATION

HEADQUARTERS AND SALES OFFICES

48720 Kato Road

Fremont, CA 94538 – USA

Tel.: +1 (510) 668-7000

Fax: +1 (510) 668-7030

www.exar.com



NOTICE

EXAR Corporation reserves the right to make changes to the products contained in this publication in order to improve design, performance or reliability. EXAR Corporation assumes no responsibility for the use of any circuits described herein, conveys no license under any patent or other right, and makes no representation that the circuits are free of patent infringement. Charts and schedules contained here in are only for illustration purposes and may vary depending upon a user's specific application. While the information in this publication has been carefully checked; no responsibility, however, is assumed for inaccuracies.

EXAR Corporation does not recommend the use of any of its products in life support applications where the failure or malfunction of the product can reasonably be expected to cause failure of the life support system or to significantly affect its safety or effectiveness. Products are not authorized for use in such applications unless EXAR Corporation receives, in writing, assurances to its satisfaction that: (a) the risk of injury or damage has been minimized; (b) the user assumes all such risks; (c) potential liability of EXAR Corporation is adequately protected under the circumstances.

Reproduction, in part or whole, without the prior written consent of EXAR Corporation is prohibited.

Компания «Океан Электроники» предлагает заключение долгосрочных отношений при поставках импортных электронных компонентов на взаимовыгодных условиях!

Наши преимущества:

- Поставка оригинальных импортных электронных компонентов напрямую с производств Америки, Европы и Азии, а так же с крупнейших складов мира;
- Широкая линейка поставок активных и пассивных импортных электронных компонентов (более 30 млн. наименований);
- Поставка сложных, дефицитных, либо снятых с производства позиций;
- Оперативные сроки поставки под заказ (от 5 рабочих дней);
- Экспресс доставка в любую точку России;
- Помощь Конструкторского Отдела и консультации квалифицированных инженеров;
- Техническая поддержка проекта, помощь в подборе аналогов, поставка прототипов;
- Поставка электронных компонентов под контролем ВП;
- Система менеджмента качества сертифицирована по Международному стандарту ISO 9001;
- При необходимости вся продукция военного и аэрокосмического назначения проходит испытания и сертификацию в лаборатории (по согласованию с заказчиком);
- Поставка специализированных компонентов военного и аэрокосмического уровня качества (Xilinx, Altera, Analog Devices, Intersil, Interpoint, Microsemi, Actel, Aeroflex, Peregrine, VPT, Syfer, Eurofarad, Texas Instruments, MS Kennedy, Miteq, Cobham, E2V, MA-COM, Hittite, Mini-Circuits, General Dynamics и др.);

Компания «Океан Электроники» является официальным дистрибьютором и эксклюзивным представителем в России одного из крупнейших производителей разъемов военного и аэрокосмического назначения «JONHON», а так же официальным дистрибьютором и эксклюзивным представителем в России производителя высокотехнологичных и надежных решений для передачи СВЧ сигналов «FORSTAR».



JONHON

«JONHON» (основан в 1970 г.)

Разъемы специального, военного и аэрокосмического назначения:

(Применяются в военной, авиационной, аэрокосмической, морской, железнодорожной, горно- и нефтедобывающей отраслях промышленности)

«FORSTAR» (основан в 1998 г.)

ВЧ соединители, коаксиальные кабели, кабельные сборки и микроволновые компоненты:

(Применяются в телекоммуникациях гражданского и специального назначения, в средствах связи, РЛС, а так же военной, авиационной и аэрокосмической отраслях промышленности).



Телефон: 8 (812) 309-75-97 (многоканальный)

Факс: 8 (812) 320-03-32

Электронная почта: ocean@oceanchips.ru

Web: <http://oceanchips.ru/>

Адрес: 198099, г. Санкт-Петербург, ул. Калинина, д. 2, корп. 4, лит. А