

17mm Rotary Type, Metal Shaft Series

Application

- ✓ Audio/video controls , Industrial control , Controls for medical equipment

Feature

- ✓ Switch option



■Specification

Total Rotational Angle	260±5°
Maximum Operating Voltage	B taper 200V A.C ; Other taper 150V A.C
Insulation Resistance	More than 50MΩ at DC 500V
Dielectric Strength	A.C 500V for 1 minute
Rotational Torque	20-200 gf.cm
Click Torque	N/A
Rotational Stop Strength of the Shaft	N/A
Push/Pull Strength of the Shaft	3 kgf.cm for 60 sec
Rotation Life	15,000 cycles
Switch Working Angle	RV170SF: 30°±10°
Switch Working Torque	RV170SF: 70-400 gf.cm
Switch Life	RV170SF: 10,000 cycles

■How to order

RV170SF – 24 – 15K – B100K

[Model](#)

[Metal Shaft Type](#)

Taper and Resistance Value

Order Code	Taper	Resistance Value
A100K	Log/A	100KΩ
B1M	Linear/B	1MΩ

Taper: A, B

Resistance Value: 1KΩ to 500KΩ and 1MΩ

*Contact us for other requirements.





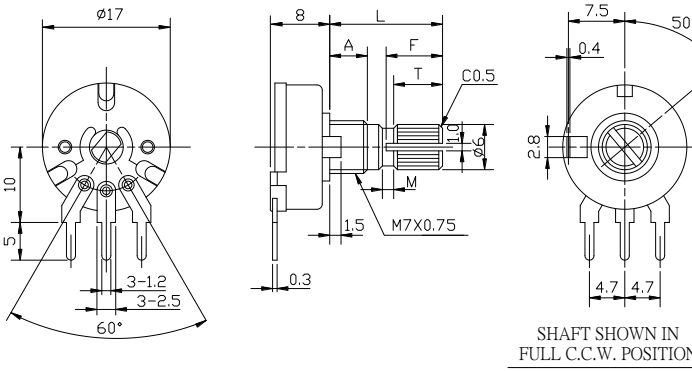
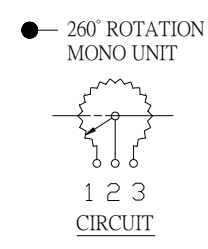

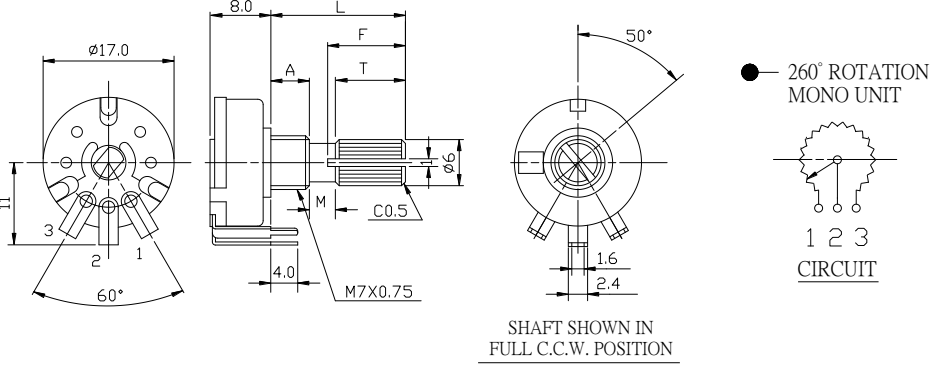

17mm Rotary Type, Metal Shaft Series

Model	Number of Unit	Switch Function	Terminal Type	With Sleeve or Bushing	Rotational Angle
RV170F-10	Single unit	N/A	Solder lug	Metal bushing	260°±5°
RV170F-24	Single unit	N/A	Horizontal	Metal bushing	260°±5°
RV170F-30	Single unit	N/A	Vertical (Front)	Metal bushing	260°±5°
RV170F-43	Single unit	N/A	Vertical	Metal bushing	260°±5°
RV170SF-10	Single unit	S.P.S.T Rotary SW	Solder lug	Metal bushing	260°±5°
RV170SF-24	Single unit	S.P.S.T Rotary SW	Horizontal	Metal bushing	260°±5°
RV170SF-30	Single unit	S.P.S.T Rotary SW	Vertical (Front)	Metal bushing	260°±5°
RV170SF-43	Single unit	S.P.S.T Rotary SW	Vertical	Metal bushing	260°±5°

Order Code	Outline Drawing
RV170F-10 	 <p>SHAFT SHOWN IN FULL C.C.W. POSITION</p>  <p>● 260° ROTATION MONO UNIT 1 2 3 CIRCUIT</p>
RV170F-24 	 <p>SHAFT SHOWN IN FULL C.C.W. POSITION</p>  <p>● 260° ROTATION MONO UNIT 1 2 3 CIRCUIT</p>

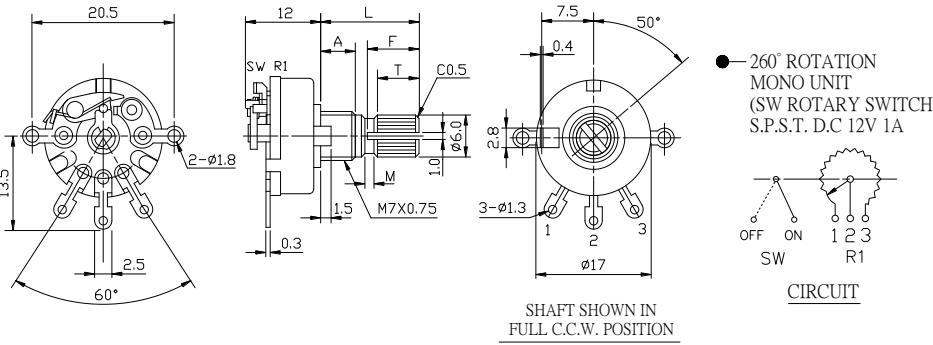
[Back to top](#)

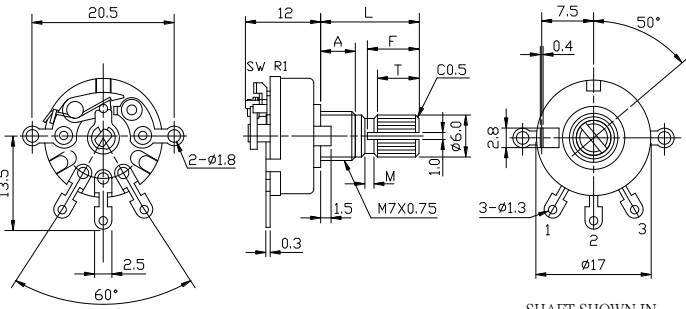
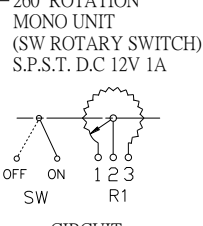
17mm Rotary Type, Metal Shaft Series

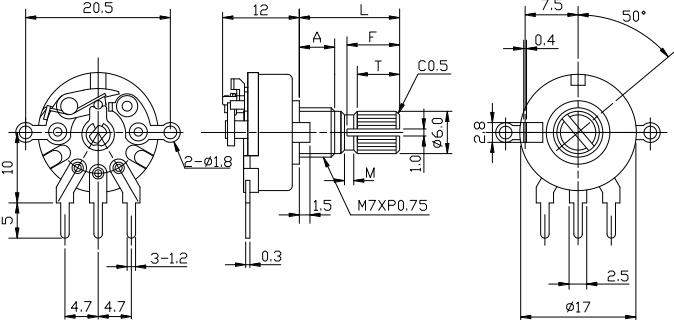
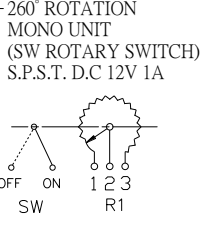
Order Code	Outline Drawing
<p>RV170F-30</p> 	 <p>SHAFT SHOWN IN FULL C.C.W. POSITION</p>  <p>● 260° ROTATION MONO UNIT</p> <p>1 2 3 CIRCUIT</p>
<p>RV170F-43</p> 	 <p>SHAFT SHOWN IN FULL C.C.W. POSITION</p>  <p>● 260° ROTATION MONO UNIT</p> <p>1 2 3 CIRCUIT</p>
<p>RV170SF-10</p> 	 <p>SHAFT SHOWN IN FULL C.C.W. POSITION</p>  <p>● 260° ROTATION MONO UNIT (SW ROTARY SWITCH) S.P.S.T. D.C 12V 1A</p> <p>OFF ON 1 2 3 SW R1 CIRCUIT</p>
<p>RV170SF-24</p> 	 <p>SHAFT SHOWN IN FULL C.C.W. POSITION</p>  <p>● 260° ROTATION MONO UNIT (SW ROTARY SWITCH) S.P.S.T. D.C 12V 1A</p> <p>OFF ON 1 2 3 SW R1 CIRCUIT</p>

[Back to top](#)

17mm Rotary Type, Metal Shaft Series

Order Code	Outline Drawing
<p>RV170SF-30</p> 	 <p>SHAFT SHOWN IN FULL C.C.W. POSITION</p>
<p>RV170SF-43</p> 	 <p>SHAFT SHOWN IN FULL C.C.W. POSITION</p>

■ Metal Shaft Type

K Type	F Type	R Type																																				
<p>A:5mm</p> 	<p>A:5mm</p> 	<p>A:5mm</p> 																																				
<table border="1"> <thead> <tr> <th>Order Code</th> <th>L</th> </tr> </thead> <tbody> <tr><td>10K</td><td>10</td></tr> <tr><td>15K</td><td>15</td></tr> <tr><td>20K</td><td>20</td></tr> <tr><td>25K</td><td>25</td></tr> <tr><td>30K</td><td>30</td></tr> </tbody> </table>	Order Code	L	10K	10	15K	15	20K	20	25K	25	30K	30	<table border="1"> <thead> <tr> <th>Order Code</th> <th>L</th> </tr> </thead> <tbody> <tr><td>10F</td><td>10</td></tr> <tr><td>15F</td><td>15</td></tr> <tr><td>20F</td><td>20</td></tr> <tr><td>25F</td><td>25</td></tr> <tr><td>30F</td><td>30</td></tr> </tbody> </table>	Order Code	L	10F	10	15F	15	20F	20	25F	25	30F	30	<table border="1"> <thead> <tr> <th>Order Code</th> <th>L</th> </tr> </thead> <tbody> <tr><td>10R</td><td>10</td></tr> <tr><td>15R</td><td>15</td></tr> <tr><td>20R</td><td>20</td></tr> <tr><td>25R</td><td>25</td></tr> <tr><td>30R</td><td>30</td></tr> </tbody> </table>	Order Code	L	10R	10	15R	15	20R	20	25R	25	30R	30
Order Code	L																																					
10K	10																																					
15K	15																																					
20K	20																																					
25K	25																																					
30K	30																																					
Order Code	L																																					
10F	10																																					
15F	15																																					
20F	20																																					
25F	25																																					
30F	30																																					
Order Code	L																																					
10R	10																																					
15R	15																																					
20R	20																																					
25R	25																																					
30R	30																																					

Design and specifications presented here are for the standard parts only. Please kindly contact us for your special requests and ask for the current technical specifications before purchase and/or use.

[Back to top](#)

Mouser Electronics

Authorized Distributor

Click to View Pricing, Inventory, Delivery & Lifecycle Information:

Alpha (Taiwan):

[RV170SF-10-20K-A13](#) [RV170SF-10-20K-A53](#) [RV170SF-10-20K-A14](#) [RV170SF-10-20K-A15](#) [RV170F-24-20K-B500O-3021](#) [RV170F-10-20K-B10K-3021](#) [RV170F-24-20K-B500K-3021](#) [RV170F-24-20K-B50K-3021](#) [RV170F-24-20K-B10K-3021](#) [RV170F-10-20K-B500O-3021](#) [RV170F-10-20K-B5K-3021](#) [RV170F-10-20K-B50K-3021](#) [RV170F-24-20K-B5K-3021](#) [RV170F-24-20K-B100K-3021](#) [RV170F-24-20K-B1K-3021](#) [RV170F-10-20K-B500K-3021](#) [RV170F-10-20K-B1K-3021](#) [RV170F-10-20K-B100K-3021](#) [RV170F-24-20K-B500_-3021](#) [RV170F-10-20K-B500_-3021](#) [RV170F-24-20K-B500ohm-3021](#)

Компания «Океан Электроники» предлагает заключение долгосрочных отношений при поставках импортных электронных компонентов на взаимовыгодных условиях!

Наши преимущества:

- Поставка оригинальных импортных электронных компонентов напрямую с производств Америки, Европы и Азии, а так же с крупнейших складов мира;
- Широкая линейка поставок активных и пассивных импортных электронных компонентов (более 30 млн. наименований);
- Поставка сложных, дефицитных, либо снятых с производства позиций;
- Оперативные сроки поставки под заказ (от 5 рабочих дней);
- Экспресс доставка в любую точку России;
- Помощь Конструкторского Отдела и консультации квалифицированных инженеров;
- Техническая поддержка проекта, помощь в подборе аналогов, поставка прототипов;
- Поставка электронных компонентов под контролем ВП;
- Система менеджмента качества сертифицирована по Международному стандарту ISO 9001;
- При необходимости вся продукция военного и аэрокосмического назначения проходит испытания и сертификацию в лаборатории (по согласованию с заказчиком);
- Поставка специализированных компонентов военного и аэрокосмического уровня качества (Xilinx, Altera, Analog Devices, Intersil, Interpoint, Microsemi, Actel, Aeroflex, Peregrine, VPT, Syfer, Eurofarad, Texas Instruments, MS Kennedy, Miteq, Cobham, E2V, MA-COM, Hittite, Mini-Circuits, General Dynamics и др.);

Компания «Океан Электроники» является официальным дистрибьютором и эксклюзивным представителем в России одного из крупнейших производителей разъемов военного и аэрокосмического назначения «JONHON», а так же официальным дистрибьютором и эксклюзивным представителем в России производителя высокотехнологичных и надежных решений для передачи СВЧ сигналов «FORSTAR».



JONHON

«JONHON» (основан в 1970 г.)

Разъемы специального, военного и аэрокосмического назначения:

(Применяются в военной, авиационной, аэрокосмической, морской, железнодорожной, горно- и нефтедобывающей отраслях промышленности)

«FORSTAR» (основан в 1998 г.)

ВЧ соединители, коаксиальные кабели, кабельные сборки и микроволновые компоненты:

(Применяются в телекоммуникациях гражданского и специального назначения, в средствах связи, РЛС, а так же военной, авиационной и аэрокосмической отраслях промышленности).



Телефон: 8 (812) 309-75-97 (многоканальный)

Факс: 8 (812) 320-03-32

Электронная почта: ocean@oceanchips.ru

Web: <http://oceanchips.ru/>

Адрес: 198099, г. Санкт-Петербург, ул. Калинина, д. 2, корп. 4, лит. А