

24V Austin Lynx™: Non-Isolated DC-DC Power Modules

18/20Vdc –30/32Vdc input; 3 to 6Vdc & 5 to 15Vdc output; 30/50W Output

RoHS Compliant



Applications

- Distributed power architectures
- Intermediate bus voltage applications
- Telecommunications equipment
- Wireless Base stations
- Industrial equipment
- LANs/WANs
- Enterprise Networks
- Latest generation IC's (DSP, FPGA, ASIC) and Microprocessor powered applications

Description

The Austin Lynx™ 24V series SMT power modules are non-isolated DC-DC converters in an industry standard package that can deliver up to 48W of output power with a full load efficiency of 94% at 12Vdc output voltage ($V_{IN} = 24Vdc$). These modules operate over a wide input voltage range ($V_{IN} = 18/20 - 30Vdc$) and provide a precisely regulated output voltage from 3 to 6Vdc (AXB030) and 5 to 15Vdc (AXB050), programmable via an external resistor. Standard features include remote On/Off, adjustable output voltage, remote sense, over current and over temperature protection.

* UL is a registered trademark of Underwriters Laboratories, Inc.

† CSA is a registered trademark of Canadian Standards Association.

‡ VDE is a trademark of Verband Deutscher Elektrotechniker e.V.

** ISO is a registered trademark of the International Organization of Standards

Features

- Compliant to RoHS EU Directive 2011/65/EU (-Z versions)
- Compliant to RoHS EU Directive 2011/65/EU under exemption 7b (Lead solder exemption). Exemption 7b will expire after June 1, 2016 at which time this product will no longer be RoHS compliant (non-Z versions)
- Wide input voltage range

AXB030:	18 to 30Vdc
AXB050:	20 to 32Vdc
- Output voltage programmable via external resistor

AXB030:	3Vdc to 6Vdc
AXB050:	5Vdc to 15Vdc
- High efficiency modules ($V_{IN} = 24Vdc$)

AXB030:	91% at 3.3V full load
AXB050:	94% at 12Vdc full load
- Low output ripple and noise
- Monotonic start-up into pre-bias output
- Remote On/Off (Positive logic)
- Remote Sense
- Small size and low profile:
33.0 mm x 13.5 mm x 8.28 mm
(1.30 in x 0.53 in x 0.326 in)
- Constant switching frequency
- Wide operating temperature range (-40°C to 85°C)
- Over current and Over temperature protection (non-latching)
- UL* 60950-1 Recognized, CSA† C22.2 No. 60950-1-03 Certified, and VDE‡ 0805:2001-12 (EN60950-1) Licensed
- ISO** 9001 and ISO 14001 certified manufacturing facilities

24V Austin Lynx™: Non-Isolated DC-DC Power Modules

18/20Vdc – 30/32Vdc input; 3 – 6Vdc & 5 – 15Vdc output; 30/50W Output

Absolute Maximum Ratings

Stresses in excess of the absolute maximum ratings can cause permanent damage to the device. These are absolute stress ratings only, functional operation of the device is not implied at these or any other conditions in excess of those given in the operations sections of the data sheet. Exposure to absolute maximum ratings for extended periods can adversely affect the device reliability.

Parameter	Device	Symbol	Min	Max	Unit
Input Voltage Continuous	All	V_{IN}	-0.3	36	Vdc
Operating Ambient Temperature (see Thermal Considerations section)	All	T_A	-40	85	°C
Storage Temperature	All	T_{stg}	-55	125	°C

Electrical Specifications

Unless otherwise indicated, specifications apply over all operating input voltage, resistive load, and temperature conditions.

Parameter	Device	Symbol	Min	Typ	Max	Unit
Operating Input Voltage	AXB030	V_{IN}	18.0	24.0	30.0	Vdc
	AXB050	V_{IN}	20.0	24.0	32.0	Vdc
Maximum Input Current ($V_{IN}=20V$, $V_O=12V$, $I_O=I_{O,max}$)	All	$I_{IN,max}$			3.5	Adc
Input No Load Current ($V_{IN}=24Vdc$, $I_O=0$, module enabled)	$V_O=3.3Vdc$	$I_{IN,No Load}$		60		mAdc
	$V_O=12Vdc$	$I_{IN,No Load}$		110		mAdc
Input Stand-by Current ($V_{IN}=24Vdc$, module disabled)	$V_O=3.3Vdc$	$I_{IN,stand-by}$			3	mA
	$V_O=12Vdc$	$I_{IN,stand-by}$			3	mA
Inrush Transient	All	I^2t			1	A ² s
Input Reflected Ripple Current, peak-to-peak (5Hz to 20MHz, 1μH source impedance; $V_{IN}=20V$ to 30V, $I_O=I_{O,max}$; See Figure 25)	All			50		mAp-p
Input Ripple Rejection (120Hz)	All		50			dB

CAUTION: These power modules can be used in a wide variety of applications ranging from simple standalone operation to an integrated part of sophisticated power architectures. To preserve maximum flexibility, no internal fuse has been provided. Also, extensive safety testing has shown that no external fuse is required to protect the unit. However, it is still recommended that some type of current-limiting power source be used to protect the module and evaluated in the end-use equipment.

24V Austin Lynx™: Non-Isolated DC-DC Power Modules

18/20Vdc – 30/32Vdc input; 3 – 6Vdc & 5 – 15Vdc output; 30/50W Output

Electrical Specifications (continued)

Parameter	Device	Symbol	Min	Typ	Max	Unit
Output Voltage Set-point ($V_{IN}=V_{N, min}$, $I_O=I_{O, max}$, $T_A=25^\circ C$)	All	$V_{O, set}$	-2.0	$V_{O, set}$	+2.0	% $V_{O, set}$
Output Voltage (Over all operating input voltage, resistive load, and temperature conditions until end of life)	All	$V_{O, set}$	-3%	—	+3%	% $V_{O, set}$
Adjustment Range Selected by an external resistor	AXB030 AXB050	V_O V_O	3.0 5.0		6.0 15.0	Vdc Vdc
Output Regulation Line ($V_{IN}=V_{IN, min}$ to $V_{IN, max}$) Load ($I_O=I_{O, min}$ to $I_{O, max}$) Temperature ($T_{ref}=T_{A, min}$ to $T_{A, max}$)	All All All		— — —	— — 0.5	0.4 0.4 1	% $V_{O, set}$ % $V_{O, set}$ % $V_{O, set}$
Output Ripple and Noise on nominal output ($V_{IN}=V_{IN, nom}$ and $I_O=I_{O, min}$ to $I_{O, max}$ Cout = 0.01 μ F ceramic//10 μ F tantalum capacitors)						
Peak-to-Peak (5Hz to 20MHz bandwidth)	AXB030		—	50	75	mV _{pk-pk}
Peak-to-Peak (5Hz to 20MHz bandwidth)	AXB050		—	100	200	mV _{pk-pk}
External Capacitance ESR \geq 1 m Ω ESR \geq 10 m Ω ESR \geq 1 m Ω ESR \geq 10 m Ω	AXB030 AXB030 AXB050 AXB050	$C_{O, max}$ $C_{O, max}$ $C_{O, max}$ $C_{O, max}$	0 0 0 0	— — — —	1,000 3,000 1,000 2,000	μ F μ F μ F μ F
Output Current ($V_{IN} = V_{IN, nom}$) $V_O = 3.3Vdc$ $V_O = 5.0Vdc$	AXB030 AXB050	I_O I_O	0 0		10 8.0	Adc Adc
Output Power ($V_{IN} = V_{IN, nom}$) $V_O = V_{O, min}$ to $V_{O, max}$	AXB030 AXB050	P_O P_O			33 50	W W
Output Short-Circuit Current ($V_O \leq 250mV$) (Hiccup Mode)	AXB030 AXB050	$I_{O, s/c}$ $I_{O, s/c}$	— —	15 20	— —	Adc Adc
Efficiency $V_{IN} = V_{IN, nom}$, $T_A = 25^\circ C$ $I_O = I_{O, max}$, $V_O = V_{O, set}$	$V_{O, set} = 3.3Vdc$ $V_{O, set} = 5.0Vdc$ $V_{O, set} = 12.0Vdc$ $V_{O, set} = 15.0Vdc$	η η η η		90 93 95 96		% % % %
Switching Frequency (Fixed)	All	f_{sw}	—	300	—	kHz

24V Austin Lynx™: Non-Isolated DC-DC Power Modules
 18/20Vdc – 30/32Vdc input; 3 - 6Vdc & 5 – 15Vdc output; 30/50W Output

Electrical Specifications (continued)

Parameter	Device	Symbol	Min	Typ	Max	Unit
Dynamic Load Response						
(dI _O /dt=5A/μs; V _{IN} =V _{IN, nom} ; T _A =25°C)						
Load Change from I _O = 50% to 100% of I _{O,max} ; No external output capacitors						
Peak Deviation (V _O = 3.3Vdc)	AXB030	V _{pk}		300		mV
Peak Deviation (V _O = 12Vdc)	AXB050	V _{pk}		220		mV
Settling Time (V _O <10% peak deviation)	All	t _s		50		μs
(dI _O /dt=5A/μs; V _{IN} =V _{IN, nom} ; T _A =25°C)						
Load Change from I _O = 100% to 50% of I _{O, max} ; No external output capacitors						
Peak Deviation (V _O = 3.3Vdc)	AXB030	V _{pk}		320		mV
Peak Deviation (V _O = 12Vdc)	AXB050	V _{pk}		220		mV
Settling Time (V _O <10% peak deviation)	All	t _s		50		μs
(dI _O /dt=5A/μs; V _{IN} =V _{IN, nom} ; T _A =25°C)						
Load Change from I _O = 50% to 100% of I _{O,max} ; 2x150 μF polymer capacitor						
Peak Deviation (V _O = 3.3Vdc)	AXB030	V _{pk}	—	120		mV
Peak Deviation (V _O = 12Vdc)	AXB050	V _{pk}	—	130		mV
Settling Time (V _O <10% peak deviation)	All	t _s	—	50		μs
(dI _O /dt=5A/μs; V _{IN} =V _{IN, nom} ; T _A =25°C)						
Load Change from I _O = 100% to 50% of I _{O,max} ; 2x150 μF polymer capacitor						
Peak Deviation (V _O = 3.3Vdc)	AXB030	V _{pk}	—	130		mV
Peak Deviation (V _O = 12Vdc)	AXB050	V _{pk}	—	130		mV
Settling Time (V _O <10% peak deviation)	All	t _s	—	50	—	μs

General Specifications

Parameter	Device	Min	Typ	Max	Unit
Calculated MTBF (V _{IN} = V _{IN, nom} , I _O = 0.8I _{O, max} , T _A =40°C) Telecordia SR 332 Issue 1: Method 1, case 3	AXB050		8,035,510		Hours
Weight		—	5.70 (0.20)	—	g (oz.)

24V Austin Lynx™: Non-Isolated DC-DC Power Modules

18/20Vdc – 30/32Vdc input; 3 - 6Vdc & 5 – 15Vdc output; 30/50W Output

Feature Specifications

Unless otherwise indicated, specifications apply over all operating input voltage, resistive load, and temperature conditions. See Feature Descriptions for additional information.

Parameter	Device	Symbol	Min	Typ	Max	Unit
On/Off Signal interface (On/Off is open collector/drain logic input; Signal referenced to GND - See feature description section) Device is with suffix "4" – Positive Logic Logic High (On/Off pin open – Module ON)						
Input High Current	All	I _{IH}		—	10	μA
Input High Voltage	All	V _{IH}	V _{IN} -2.5V	—	30	V
Logic Low (Module OFF)						
Input Low Current	All	I _{IL}	—	—	1	mA
Input Low Voltage	All	V _{IL}	-0.3	—	1.2	V
Turn-On Delay and Rise Times (V _{IN} =V _{IN,nom} , I _o =I _{o,max} , V _o to within ±1% of steady state)						
Case 1: On/Off input is enabled and then input power is applied (delay from instant at which V _{IN} = V _{IN,min} until V _o = 10% of V _{o,set})	All	T _{delay}	2	4	8	msec
Case 2: Input power is applied for at least one second and then the On/Off input is enabled (delay from instant at which Von/Off is enabled until V _o = 10% of V _{o,set})	All	T _{delay}	2	4	8	msec
Output voltage Rise time (time for V _o to rise from 10% of V _{o,set} to 90% of V _{o,set})	All	T _{rise}	2	5	9	msec
Output voltage overshoot I _o = I _{o,max} ; V _{IN,min} – V _{IN,max} , T _A = 25 °C					3.0	% V _{o,set}
Remote Sense Range			—	—	0.5	V
Over temperature Protection (See Thermal Consideration section)	All	T _{ref}	—	125	135	°C
Input Undervoltage Lockout						
Turn-on Threshold	AXB030				17	Vdc
	AXB050				19	Vdc
Turn-off Threshold	AXB030		15			Vdc
	AXB050		17			Vdc

24V Austin Lynx™: Non-Isolated DC-DC Power Modules

18/20Vdc – 30/32Vdc input; 3 – 6Vdc & 5 – 15Vdc output; 30/50W Output

Characteristic Curves

The following figures provide typical characteristics for the AXB030X module at 3.3V, 10A and 25°C.

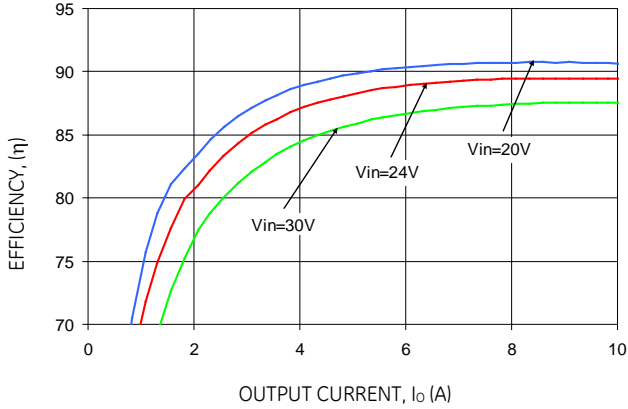

Figure 1. Converter Efficiency versus Output Current.

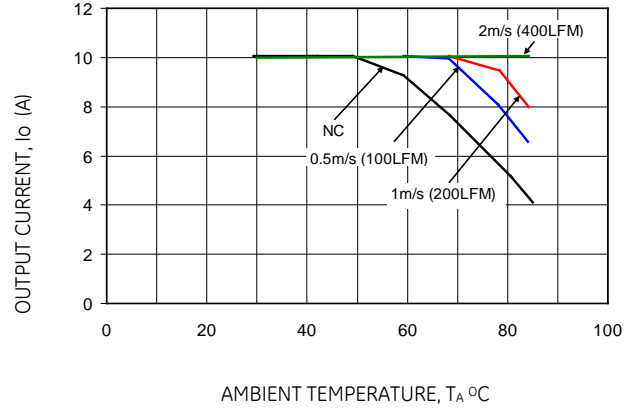

Figure 4. Derating Output Current versus Local Ambient Temperature and Airflow.

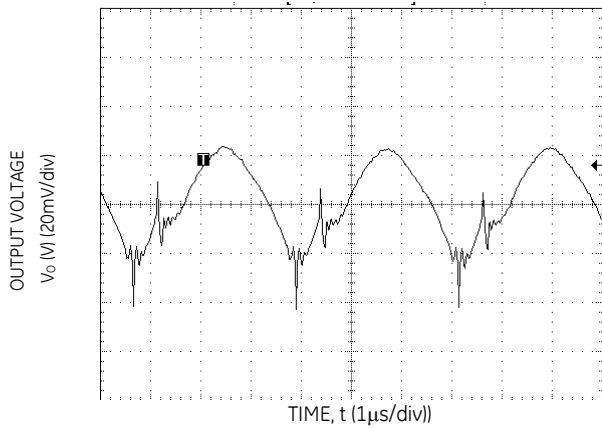

Figure 2. Typical output ripple and noise ($V_{IN} = V_{IN,NOM}$, $I_o = I_{o,max}$).

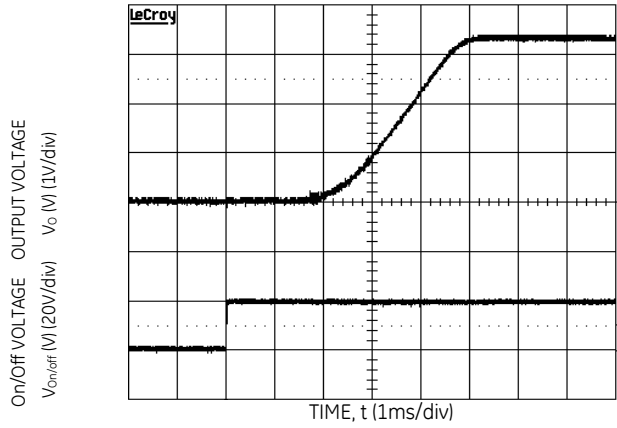

Figure 5. Typical Start-up Using Remote On/Off ($V_{IN} = 20V$, $I_o = I_{o,max}$).

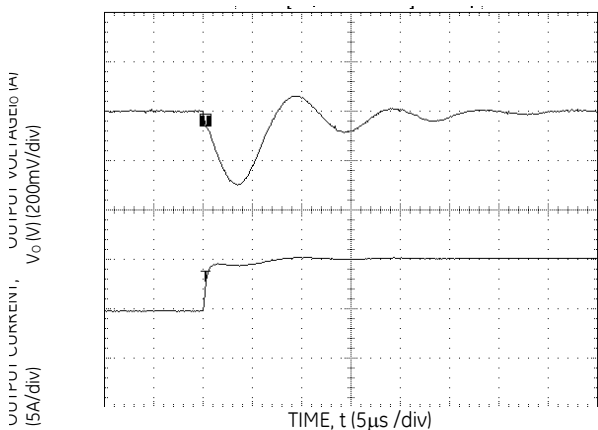

Figure 3. Transient Response to Dynamic Load Change from 50% to 100% of full load with di/dt of 5A/µs.

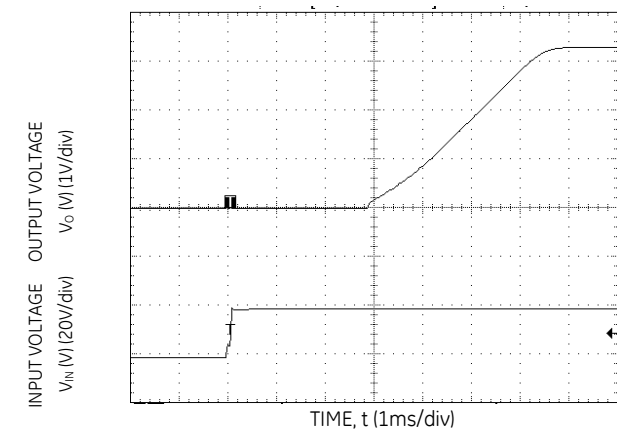

Figure 6. Typical Start-up Using Input Voltage ($V_{IN} = 20V$, $I_o = I_{o,max}$).

24V Austin Lynx™: Non-Isolated DC-DC Power Modules

18/20Vdc – 30/32Vdc input; 3 – 6Vdc & 5 – 15Vdc output; 30/50W Output

Characteristic Curves (continued)

The following figures provide typical characteristics for the AXB050X module at 5V, 8A and 25°C.

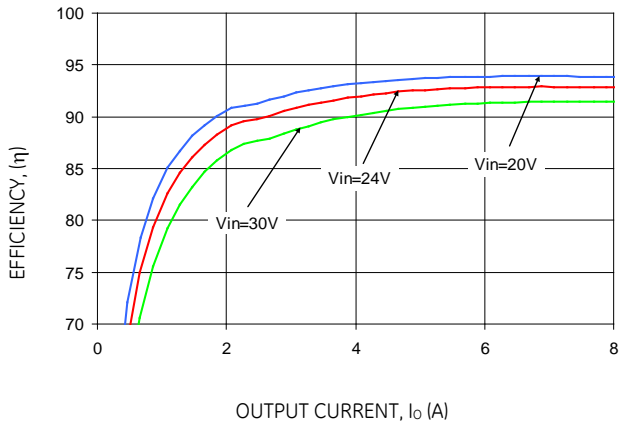

Figure 7. Converter Efficiency versus Output Current.

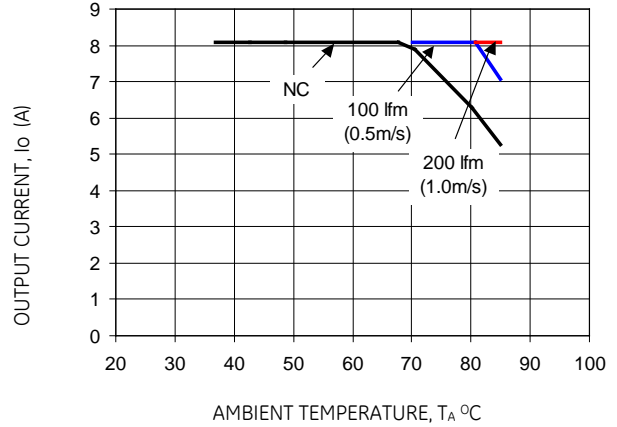

Figure 10. Derating Output Current versus Local Ambient Temperature and Airflow ($V_{IN} = V_{IN,NOM}$).

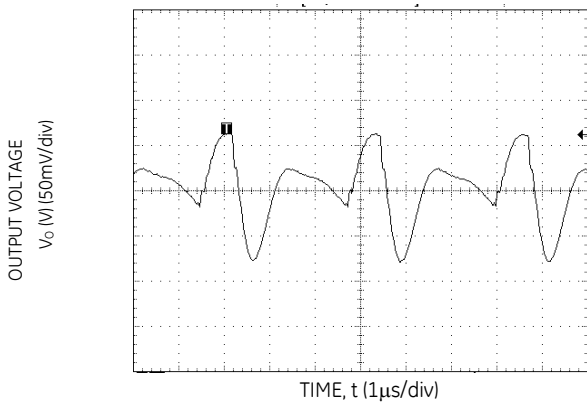

Figure 8. Typical output ripple and noise ($V_{IN} = V_{IN,NOM}$, $I_o = I_{o,max}$).

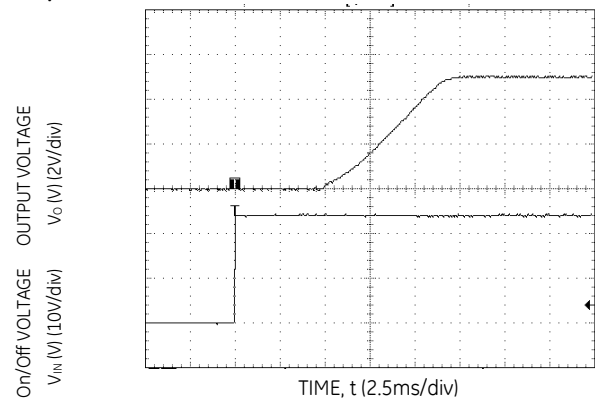

Figure 11. Typical Start-up Using Remote On/Off ($V_{IN} = 24V$, $I_o = I_{o,max}$).

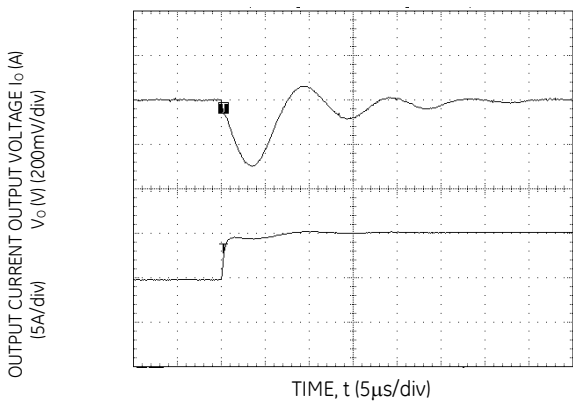

Figure 9. Transient Response to Dynamic Load change from 50% to 100% of full load with di/dt of 5A/µs.

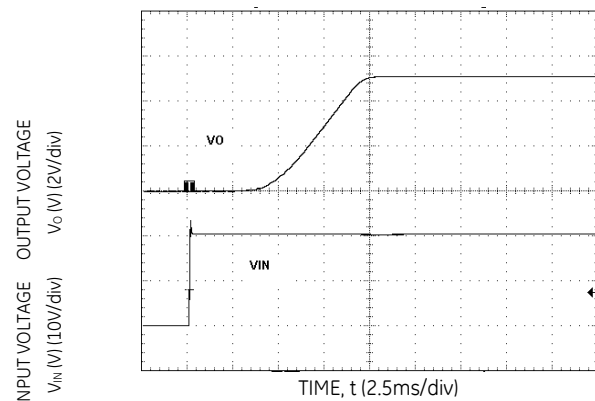

Figure 12. Typical Start-up Using Input Voltage ($V_{IN} = 20V$, $I_o = I_{o,max}$).

24V Austin Lynx™: Non-Isolated DC-DC Power Modules

18/20Vdc – 30/32Vdc input; 3 – 6Vdc & 5 – 15Vdc output; 30/50W Output

Characteristic Curves (continued)

The following figures provide typical characteristics for the AXB050X module at 12V, 4A and 25°C.

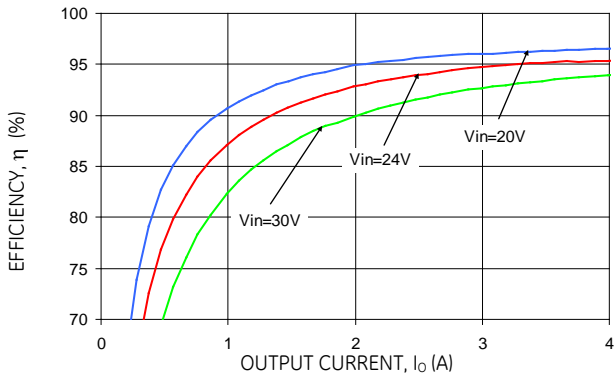

Figure 13. Converter Efficiency versus Output Current.

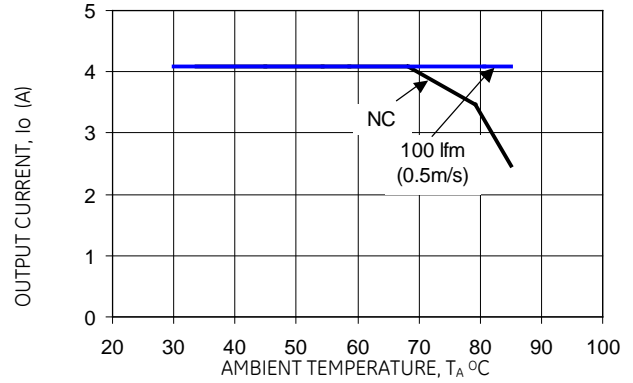

Figure 16. Derating Output Current versus Local Ambient Temperature and Airflow.

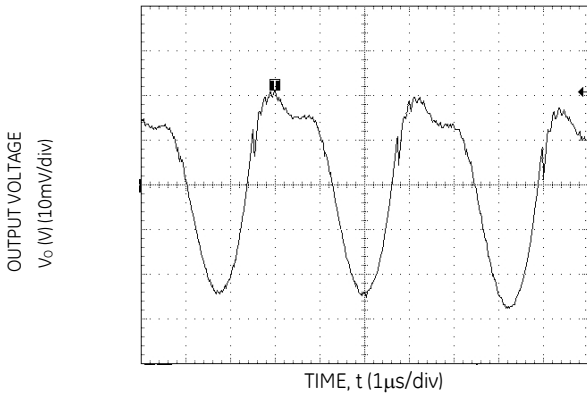

Figure 14. Typical output ripple and noise ($V_{IN} = V_{IN,NOM}$, $I_o = I_{o,max}$).

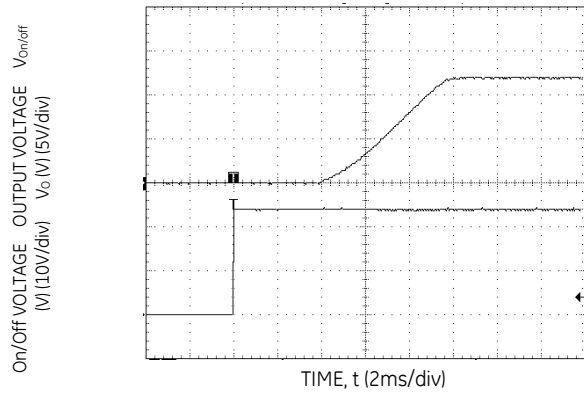

Figure 17. Typical Start-up Using Remote On/Off ($V_{IN} = V_{IN,NOM}$, $I_o = I_{o,max}$).

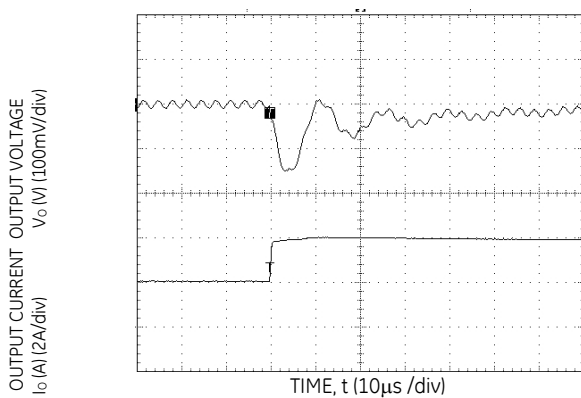

Figure 15. Transient Response to Dynamic Load change from 50% to 100% of full load with di/dt of 5A/µs.

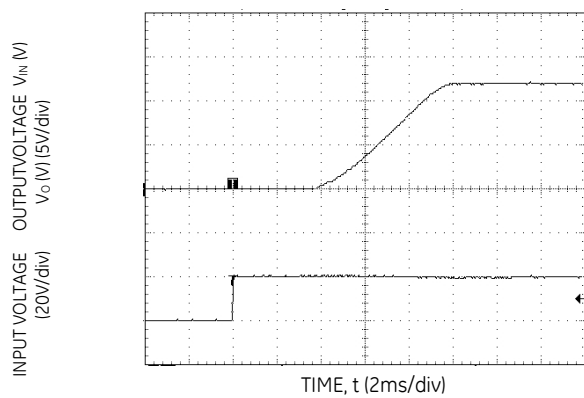

Figure 18. Typical Start-up Using Input Voltage ($V_{IN} = 20V$, $I_o = I_{o,max}$).

24V Austin Lynx™: Non-Isolated DC-DC Power Modules

18/20Vdc – 30/32Vdc input; 3 – 6Vdc & 5 – 15Vdc output; 30/50W Output

Characteristic Curves (continued)

The following figures provide typical characteristics for the AXB050X module at 15V, 3A and 25°C.

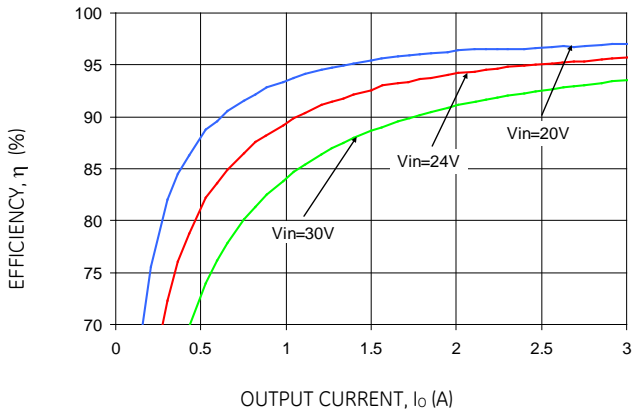

Figure 19. Converter Efficiency versus Output Current.

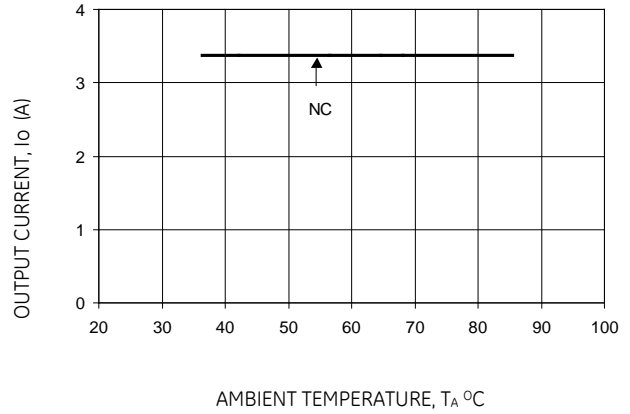

Figure 22. Derating Output Current versus Local Ambient Temperature and Airflow.

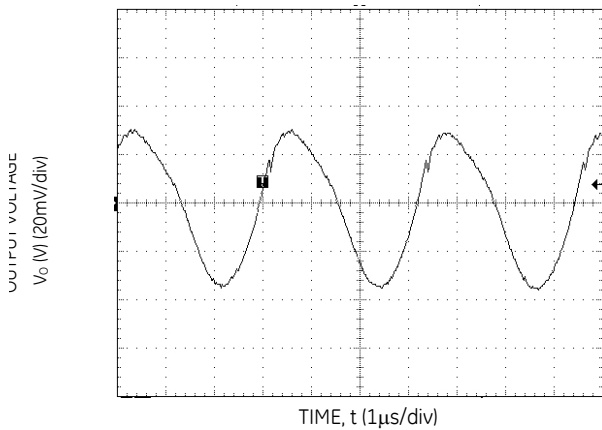

Figure 20. Typical output ripple and noise ($V_{IN} = V_{IN,NOM}$, $I_o = I_{o,max}$).

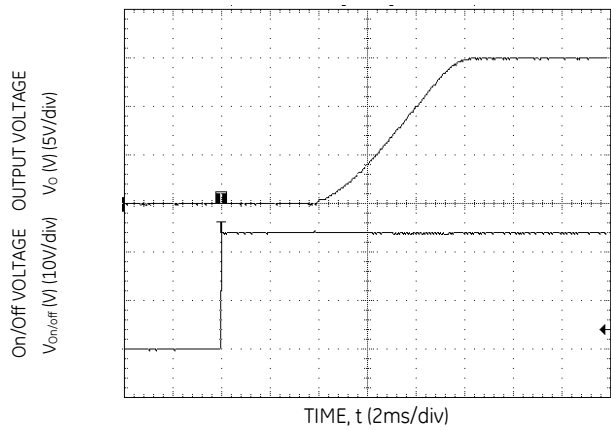

Figure 23. Typical Start-up Using Remote On/Off ($V_{IN} = V_{IN,NOM}$, $I_o = I_{o,max}$).

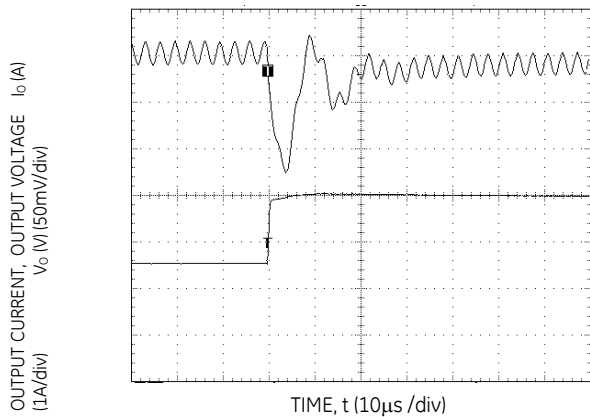

Figure 21. Transient Response to Dynamic Load change from 50% to 100% of full load with di/dt of $5A/\mu s$.

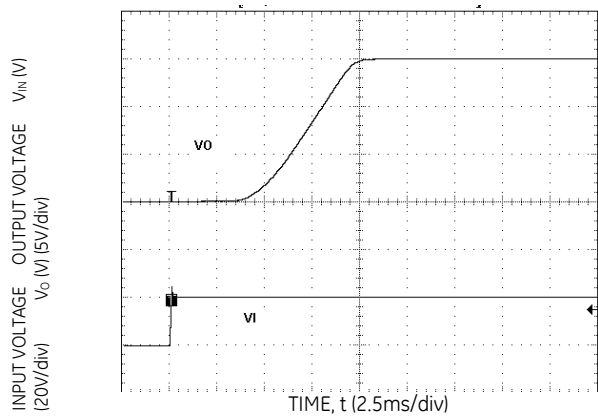
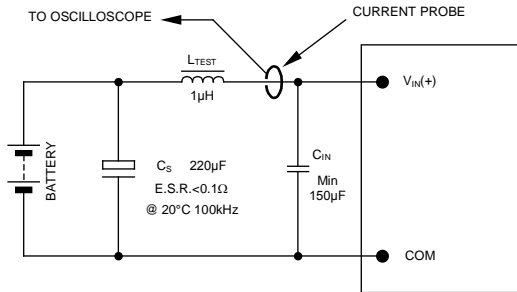

Figure 24. Typical Start-up Using Input Voltage ($V_{IN} = 20V$, $I_o = I_{o,max}$).

24V Austin Lynx™: Non-Isolated DC-DC Power Modules

18/20Vdc – 30/32Vdc input; 3 – 6Vdc & 5 – 15Vdc output; 30/50W Output

Test Configurations



NOTE: Measure input reflected ripple current with a simulated source inductance (L_{TEST}) of 1µH. Capacitor C_S offsets possible battery impedance. Measure current as shown above.

Figure 25. Input Reflected Ripple Current Test Setup.

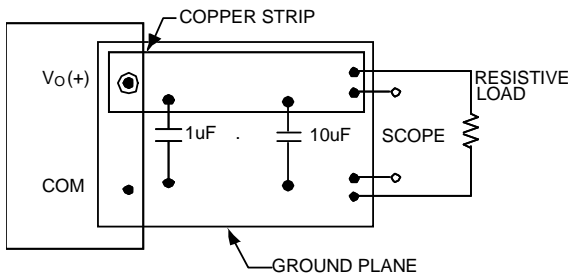

NOTE: All voltage measurements to be taken at the module terminals, as shown above. If sockets are used then Kelvin connections are required at the module terminals to avoid measurement errors due to socket contact resistance.

Figure 26. Output Ripple and Noise Test Setup.

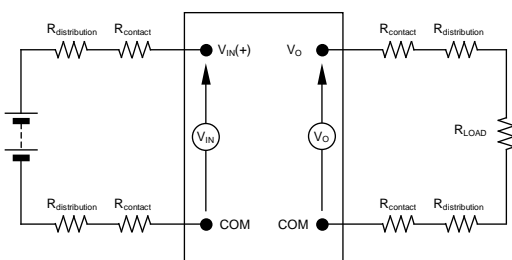

NOTE: All voltage measurements to be taken at the module terminals, as shown above. If sockets are used then Kelvin connections are required at the module terminals to avoid measurement errors due to socket contact resistance.

Figure 27. Output Voltage and Efficiency Test Setup.

$$\text{Efficiency } \eta = \frac{V_O \cdot I_O}{V_{IN} \cdot I_{IN}} \times 100 \%$$

Design Considerations

Input Filtering

The Austin Lynx™ 24V SMT module should be connected to a low-impedance source. A highly inductive source can affect the stability of the module. An input capacitance must be placed directly adjacent to the input pin of the module, to minimize input ripple voltage and ensure module stability.

Output Filtering

The Austin Lynx™ 24V SMT module is designed for low output ripple voltage and will meet the maximum output ripple specification with 1 µF ceramic and 10 µF tantalum capacitors at the output of the module. However, additional output filtering may be required by the system designer for a number of reasons. First, there may be a need to further reduce the output ripple and noise of the module. Second, the dynamic response characteristics may need to be customized to a particular load step change.

To reduce the output ripple and improve the dynamic response to a step load change, additional capacitance at the output can be used. Low ESR polymer and ceramic capacitors are recommended to improve the dynamic response of the module. For stable operation of the module, limit the capacitance to less than the maximum output capacitance as specified in the electrical specification table.

Safety Considerations

For safety agency approval the power module must be installed in compliance with the spacing and separation requirements of the end-use safety agency standards, i.e., UL 60950, CSA C22.2 No. 60950-00, EN60950 (VDE 0850) (IEC60950, 3rd edition) Licensed.

For the converter output to be considered meeting the requirements of safety extra-low voltage (SELV), the input must meet SELV requirements. The power module has extra-low voltage (ELV) outputs when all inputs are ELV.

24V Austin Lynx™: Non-Isolated DC-DC Power Modules

18/20Vdc – 30/32Vdc input; 3 - 6Vdc & 5 – 15Vdc output; 30/50W Output

Feature Description

Remote On/Off

The Austin Lynx™ 24V SMT power modules feature an On/Off pin for remote On/Off operation. Positive Logic On/Off signal, device code suffix “4”, turns the module ON during a logic High on the On/Off pin and turns the module OFF during a logic Low.

For positive logic modules, the circuit configuration for using the On/Off pin is shown in Figure 28. The On/Off pin is an open collector/drain logic input signal ($V_{ON/OFF}$) that is referenced to ground. During a logic-high (On/Off pin is pulled high internal to the module) when the transistor Q1 is in the Off state, the power module is ON. Maximum allowable leakage current of the transistor when $V_{ON/OFF} = V_{IN,max}$ is 10µA. Applying a logic-low when the transistor Q1 is turned-On, the power module is OFF. During this state $V_{ON/OFF}$ must be less than 1.2V. When not using positive logic On/off pin, leave the pin unconnected or tie to V_{IN} .

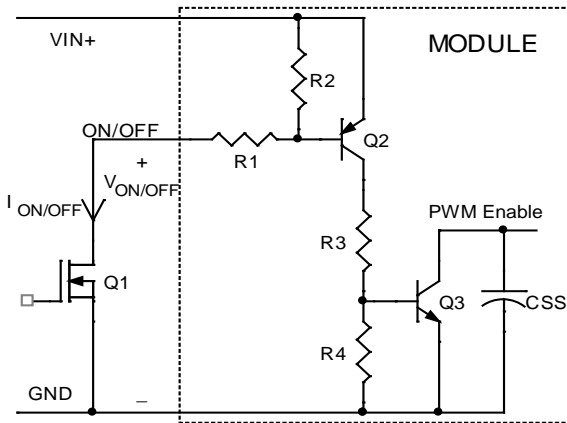

Figure 28. Remote On/Off Implementation circuit.

Remote Sense

The Austin Lynx 24V power modules have a Remote Sense feature to minimize the effects of distribution losses by regulating the voltage at the Remote Sense pin (See Figure 29). The voltage between the Sense pin and V_o pin must not exceed 0.5V.

The amount of power delivered by the module is defined as the output voltage multiplied by the output current ($V_o \times I_o$). When using Remote Sense, the output voltage of the module can increase which increases the power output of the module. Make sure that the maximum output power of the module remains at or below the maximum rated power. When the Remote Sense feature is not being used, connect the Remote Sense pin to the output of the module.

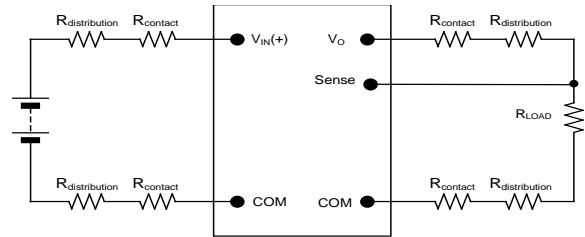

Figure 29. Effective Circuit Configuration for Remote Sense operation.

Overcurrent Protection

To provide protection in a fault (output overload) condition, the unit is equipped with internal current-limiting circuitry and can endure current limiting continuously. At the point of current-limit inception, the unit enters hiccup mode. The unit operates normally once the output current is brought back into its specified range. The average output current during hiccup is 20% $I_{o,max}$.

Input Undervoltage Lockout

At input voltages below the input undervoltage lockout limit, the module operation is disabled. The module will begin to operate at an input voltage above the undervoltage lockout turn-on threshold.

Overtemperature Protection

To provide protection in a fault condition, the unit is equipped with a thermal shutdown circuit. The unit will shutdown if the overtemperature threshold of 130°C is exceeded at the thermal reference point T_{ref} . The thermal shutdown is not intended as a guarantee that the unit will survive temperatures beyond its rating. Once the unit goes into thermal shutdown it will then wait to cool before attempting to restart.

Output Voltage Programming

The output voltage of the Austin Lynx 24V can be programmed to any voltage in the specified ranges by connecting a resistor (shown as R_{trim} in Figure 30) between the Trim and GND pins of the module. Without an external resistor between the Trim and GND pins, the output of the module will be at the low-end of the specified range. To calculate the value of the trim resistor, R_{trim} for a desired output voltage, use the following equations:

For the AX030A0X modules,

$$R_{trim} = \left[\frac{10500}{V_o - 3.018} - 3480 \right] \Omega$$

24V Austin Lynx™: Non-Isolated DC-DC Power Modules

18/20Vdc – 30/32Vdc input; 3 - 6Vdc & 5 – 15Vdc output; 30/50W Output

Feature Descriptions (continued)

Output Voltage Programming (continued)

For the AX050A0X modules,

$$R_{trim} = \left[\frac{10500}{V_o - 5.021} - 1000 \right] \Omega$$

where, R_{trim} is the external resistor in Ω and V_o is the desired output voltage

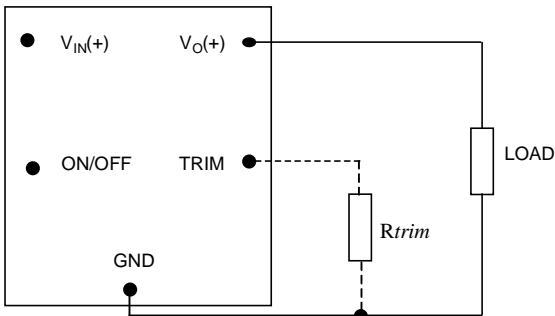

Figure 30. Circuit configuration to program output voltage using an external resistor.

By using a $\pm 0.5\%$ tolerance trim resistor with a TC of ± 100 ppm, a set point tolerance of $\pm 2\%$ can be achieved as specified in the electrical specifications. The POL Programming Tool, available at www.GEcriticalpower.com under the Design Tools section, helps determine the required external trim resistor needed for a specific output voltage.

Voltage Margining

Output voltage margining can be implemented in the Austin Lynx 24V modules by connecting a resistor, $R_{margin-up}$, from the Trim pin to the ground pin for margining-up the output voltage and by connecting a resistor, $R_{margin-down}$, from the Trim pin to output pin for margining-down. Figure 31 shows the circuit configuration for output voltage margining. The POL Programming Tool, available at www.GEcriticalpower.com under the Design Tools section, also calculates the values of $R_{margin-up}$ and $R_{margin-down}$ for a specific output voltage and % margin. Please consult your local GE technical representative for additional details.

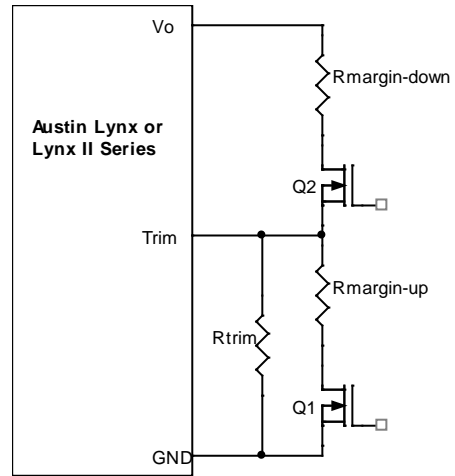

Figure 31. Circuit Configuration for margining the output voltage.

24V Austin Lynx™: Non-Isolated DC-DC Power Modules

18/20Vdc – 30/32Vdc input; 3 – 6Vdc & 5 – 15Vdc output; 30/50W Output

Thermal Considerations

Power modules operate in a variety of thermal environments; however, sufficient cooling should always be provided to help ensure reliable operation.

Considerations include ambient temperature, airflow, module power dissipation, and the need for increased reliability. A reduction in the operating temperature of the module will result in an increase in reliability. The thermal data presented here is based on physical measurements taken in a wind tunnel. The test set-up is shown in Figure 32. Note that the airflow is parallel to the long axis of the module as shown in figure 32. The derating data applies to airflow in either direction of the module's long axis.

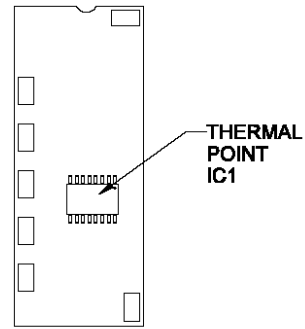

Figure 33. T_{ref} Temperature measurement location.

The thermal reference point, T_{ref} used in the specifications is shown in Figure 33. For reliable operation this temperature should not exceed 125°C.

The output power of the module should not exceed the rated power of the module (V_{o,set} x I_{o,max}).

Please refer to the Application Note “Thermal Characterization Process For Open-Frame Board-Mounted Power Modules” for a detailed discussion of thermal aspects including maximum device temperatures.

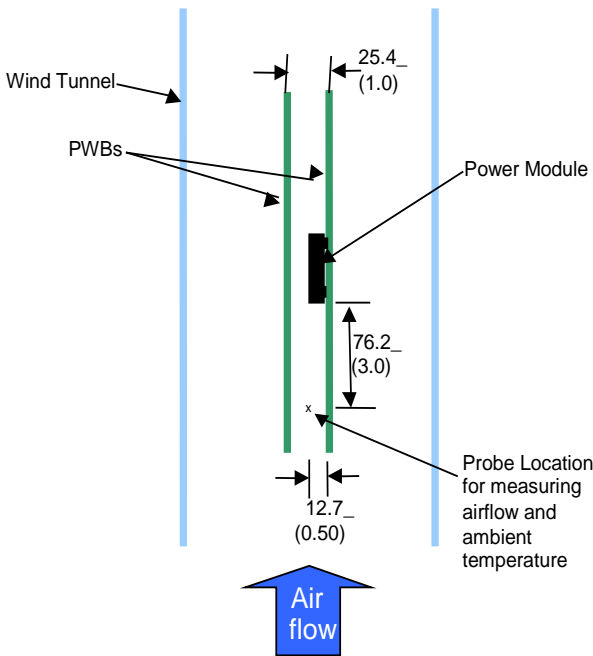

Figure 32. Thermal Test Set-up.

24V Austin Lynx™: Non-Isolated DC-DC Power Modules

18/20Vdc – 30/32Vdc input; 3 - 6Vdc & 5 – 15Vdc output; 30/50W Output

Mechanical Outline

Dimensions are in millimeters and (inches).

Tolerances: x.x mm ± 0.5 mm (x.xx in. ± 0.02 in.) [unless otherwise indicated]

x.xx mm ± 0.25 mm (x.xxx in ± 0.010 in.)

BOTTOM VIEW OF BOARD

SIDE VIEW

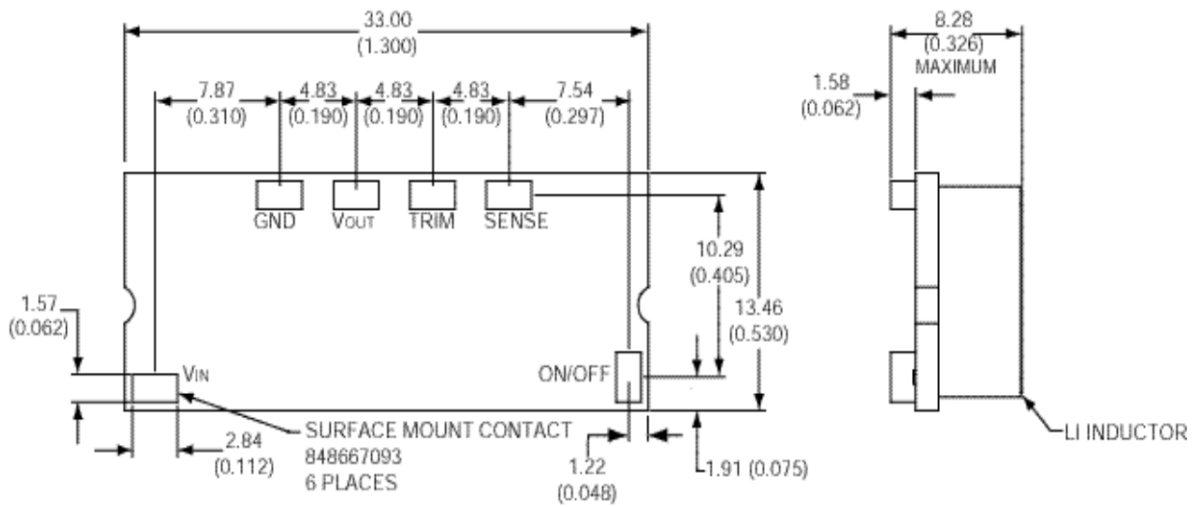

Non Co-planarity (max): 0.15 (0.006)

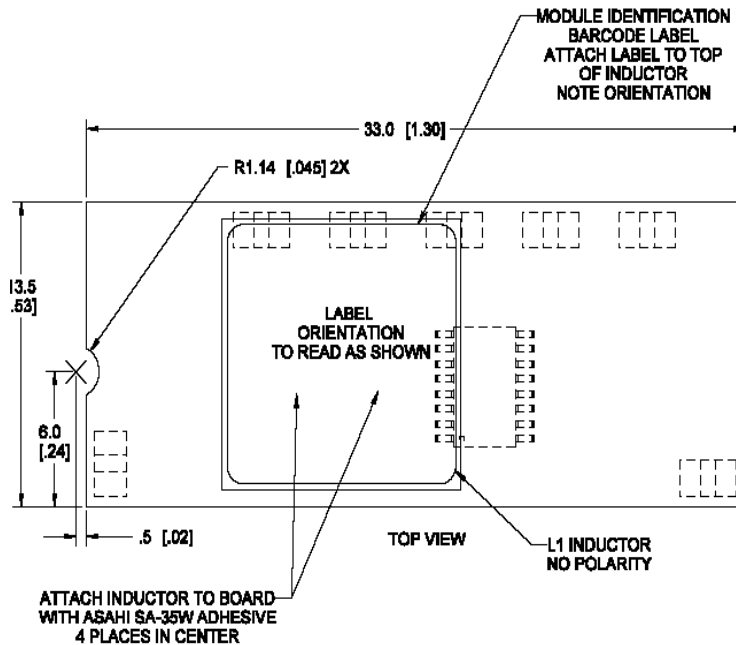

24V Austin Lynx™: Non-Isolated DC-DC Power Modules

18/20Vdc – 30/32Vdc input; 3 - 6Vdc & 5 – 15Vdc output; 30/50W Output

Recommended Pad Layout

Dimensions are in millimeters and (inches).

Tolerances: x.x mm ± 0.5 mm (x.xx in. ± 0.02 in.) [unless otherwise indicated]

x.xx mm ± 0.25 mm (x.xxx in ± 0.010 in.)

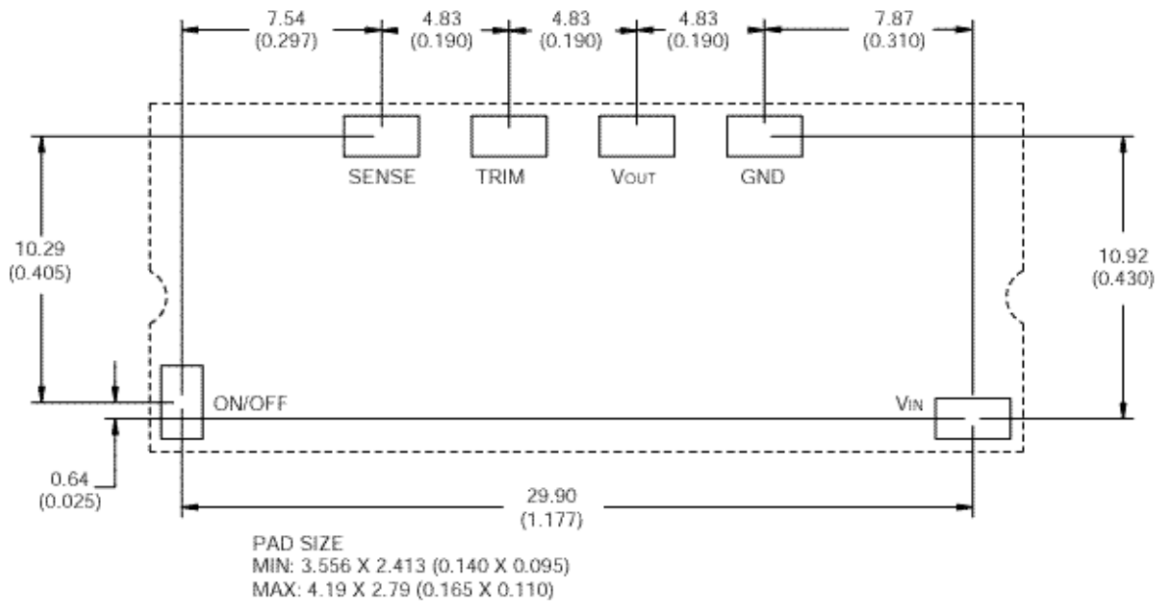

24V Austin Lynx™: Non-Isolated DC-DC Power Modules

18/20Vdc – 30/32Vdc input; 3 - 6Vdc & 5 – 15Vdc output; 30/50W Output

Packaging Details

The Austin Lynx™ 24V SMT versions are supplied in tape & reel as standard. Modules are shipped in quantities of 250 modules per reel.

Tape Dimensions

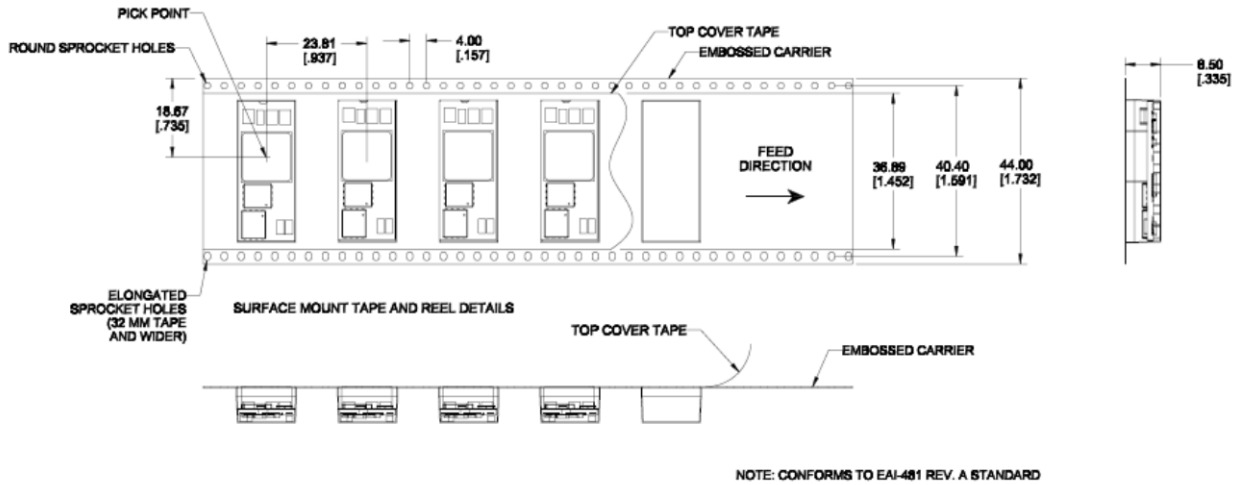

Reel Dimensions

- Outside diameter: 330.2 mm (13.00")
- Inside diameter: 177.8 mm (7.00")
- Tape Width: 44.0 mm (1.73")

24V Austin Lynx™: Non-Isolated DC-DC Power Modules

18/20Vdc – 30/32Vdc input; 3 - 6Vdc & 5 – 15Vdc output; 30/50W Output

Surface Mount Information

Pick and Place

The Austin Lynx™ 24V SMT modules use open frame construction and are designed for fully automated assembly process. The modules are fitted with a label designed to provide a large surface area for pick and place operation. The label meets all the requirements for surface mount processing, as well as safety standards, and is able to withstand reflow temperatures of up to 300°C. The label also carries product information such as product code, serial number and location of manufacture.

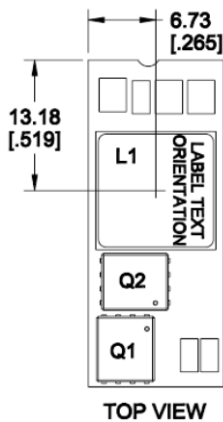

Figure 34. Pick and place Location.

Nozzle Recommendations

The module weight has been kept to a minimum by using open frame construction. Even so, these modules have a relatively large mass when compared to conventional SMT components. Variables such as nozzle size, tip style, vacuum pressure and placement speed should be considered to optimize this process. The minimum recommended nozzle diameter for reliable operation is 6mm. The maximum nozzle outer diameter, which will safely fit within the allowable component spacing, is 9 mm.

Oblong or oval nozzles up to 11 x 9 mm may also be used within the space available.

For further information please contact your local GE technical representative.

Tin Lead Soldering

The Austin Lynx™ 24V SMT power modules are lead free modules and can be soldered either in a lead-free solder process or in a conventional Tin/Lead (Sn/Pb) process. It is recommended that the customer review data sheets in order to customize the solder reflow profile for each application board assembly. The following instructions must be observed when soldering these units. Failure to observe these instructions may result in the failure of or cause damage to the modules, and can adversely affect long-term reliability.

In a conventional Tin/Lead (Sn/Pb) solder process peak reflow temperatures are limited to less than 235°C. Typically, the eutectic solder melts at 183°C, wets the land, and subsequently wicks the device connection. Sufficient time must be allowed to fuse the plating on the connection to ensure a reliable solder joint. There are several types of SMT reflow technologies currently used in the industry. These surface mount power modules can be reliably soldered using natural forced convection, IR (radiant infrared), or a combination of convection/IR. For reliable soldering the solder reflow profile should be established by accurately measuring the modules CP connector temperatures.

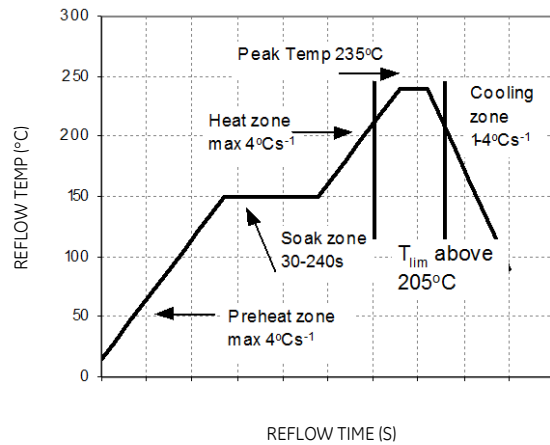

Figure 35. Reflow Profile for Tin/Lead (Sn/Pb) process.

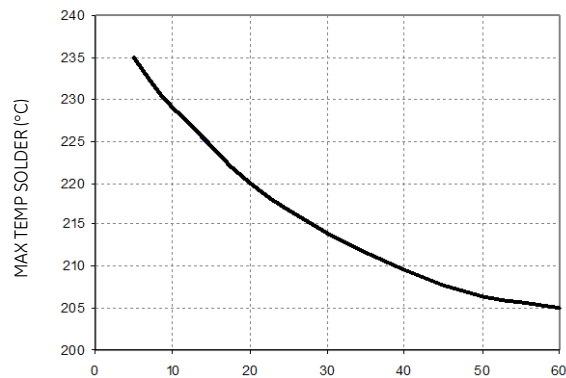

Figure 36. Time Limit Curve Above 205°C for Tin/Lead (Sn/Pb) process.

24V Austin Lynx™: Non-Isolated DC-DC Power Modules

18/20Vdc – 30/32Vdc input; 3 - 6Vdc & 5 – 15Vdc output; 30/50W Output

Surface Mount Information (continued)

Lead Free Soldering

The -Z version Austin Lynx 24V SMT modules are lead-free (Pb-free) and RoHS compliant and are both forward and backward compatible in a Pb-free and a SnPb soldering process. Failure to observe the instructions below may result in the failure of or cause damage to the modules and can adversely affect long-term reliability.

Pb-free Reflow Profile

Power Systems will comply with J-STD-020 Rev. C (Moisture/Reflow Sensitivity Classification for Nonhermetic Solid State Surface Mount Devices) for both Pb-free solder profiles and MSL classification procedures. This standard provides a recommended forced-air-convection reflow profile based on the volume and thickness of the package (table 4-2). The suggested Pb-free solder paste is Sn/Ag/Cu (SAC). The recommended linear reflow profile using Sn/Ag/Cu solder is shown in Figure. 37.

MSL Rating

The Austin Lynx 24V SMT modules have an MSL rating of 2a.

Storage and Handling

The recommended storage environment and handling procedures for moisture-sensitive surface mount packages is detailed in J-STD-033 Rev. A (Handling, Packing, Shipping and Use of Moisture/Reflow Sensitive Surface Mount Devices). Moisture barrier bags (MBB) with desiccant are required for MSL ratings of 2 or greater. These sealed packages should not be broken until time of use. Once the original package is broken, the floor life of the product at conditions of $\leq 30^{\circ}\text{C}$ and 60% relative humidity varies according to the MSL rating (see J-STD-033A). The shelf life for dry packed SMT packages will be a minimum of 12 months from the bag seal date, when stored at the following conditions: $< 40^{\circ}\text{C}$, $< 90\%$ relative humidity.

Post Solder Cleaning and Drying Considerations

Post solder cleaning is usually the final circuit-board assembly process prior to electrical board testing. The result of inadequate cleaning and drying can affect both the reliability of a power module and the testability of the finished circuit-board assembly. For guidance on appropriate soldering, cleaning and drying procedures, refer to *Board Mounted Power Modules: Soldering and Cleaning Application Note (AN04-001)*.

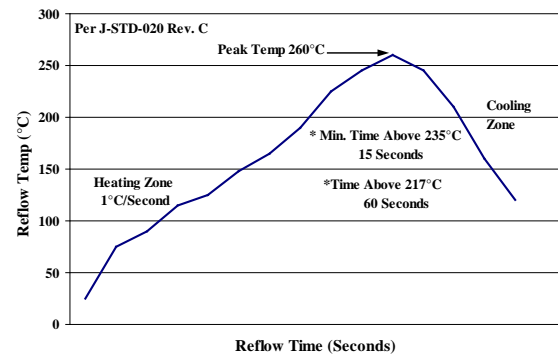

Figure 37. Recommended linear reflow profile using Sn/Ag/Cu solder.

24V Austin Lynx™: Non-Isolated DC-DC Power Modules

18/20Vdc – 30/32Vdc input; 3 – 6Vdc & 5 – 15Vdc output; 30/50W Output

Ordering Information

Please contact your GE Sales Representative for pricing, availability and optional features.

Table 1. Device Codes

Device Code	Input Voltage Range	Output Voltage	Output Power	On/Off Logic	Connector Type	Comcodes
AXB030X43-SR	18 – 30Vdc	3.0 – 6.0Vdc	30W	Positive	SMT	108992673
AXB030X43-SRZ	18 – 30Vdc	3.0 – 6.0Vdc	30W	Positive	SMT	CC109106738
AXB050X43-SR	20 – 32Vdc	5.0 – 15.0Vdc	50W	Positive	SMT	108992681
AXB050X43-SRZ	20 – 32Vdc	5.0 – 15.0Vdc	50W	Positive	SMT	CC109104857

-Z refers to RoHS-compliant codes

Contact Us

For more information, call us at

USA/Canada:

+1 877 546 3243, or +1 972 244 9288

Asia-Pacific:

+86.021.54279977*808

Europe, Middle-East and Africa:

+49.89.878067-280

www.gecriticalpower.com



GE Critical Power reserves the right to make changes to the product(s) or information contained herein without notice, and no liability is assumed as a result of their use or application. No rights under any patent accompany the sale of any such product(s) or information.

Компания «Океан Электроники» предлагает заключение долгосрочных отношений при поставках импортных электронных компонентов на взаимовыгодных условиях!

Наши преимущества:

- Поставка оригинальных импортных электронных компонентов напрямую с производств Америки, Европы и Азии, а так же с крупнейших складов мира;
- Широкая линейка поставок активных и пассивных импортных электронных компонентов (более 30 млн. наименований);
- Поставка сложных, дефицитных, либо снятых с производства позиций;
- Оперативные сроки поставки под заказ (от 5 рабочих дней);
- Экспресс доставка в любую точку России;
- Помощь Конструкторского Отдела и консультации квалифицированных инженеров;
- Техническая поддержка проекта, помощь в подборе аналогов, поставка прототипов;
- Поставка электронных компонентов под контролем ВП;
- Система менеджмента качества сертифицирована по Международному стандарту ISO 9001;
- При необходимости вся продукция военного и аэрокосмического назначения проходит испытания и сертификацию в лаборатории (по согласованию с заказчиком);
- Поставка специализированных компонентов военного и аэрокосмического уровня качества (Xilinx, Altera, Analog Devices, Intersil, Interpoint, Microsemi, Actel, Aeroflex, Peregrine, VPT, Syfer, Eurofarad, Texas Instruments, MS Kennedy, Miteq, Cobham, E2V, MA-COM, Hittite, Mini-Circuits, General Dynamics и др.);

Компания «Океан Электроники» является официальным дистрибьютором и эксклюзивным представителем в России одного из крупнейших производителей разъемов военного и аэрокосмического назначения «JONHON», а так же официальным дистрибьютором и эксклюзивным представителем в России производителя высокотехнологичных и надежных решений для передачи СВЧ сигналов «FORSTAR».



JONHON

«JONHON» (основан в 1970 г.)

Разъемы специального, военного и аэрокосмического назначения:

(Применяются в военной, авиационной, аэрокосмической, морской, железнодорожной, горно- и нефтедобывающей отраслях промышленности)

«FORSTAR» (основан в 1998 г.)

ВЧ соединители, коаксиальные кабели, кабельные сборки и микроволновые компоненты:

(Применяются в телекоммуникациях гражданского и специального назначения, в средствах связи, РЛС, а так же военной, авиационной и аэрокосмической отраслях промышленности).



Телефон: 8 (812) 309-75-97 (многоканальный)

Факс: 8 (812) 320-03-32

Электронная почта: ocean@oceanchips.ru

Web: <http://oceanchips.ru/>

Адрес: 198099, г. Санкт-Петербург, ул. Калинина, д. 2, корп. 4, лит. А