

Recommended Noise Filter
NAC-06-472



High voltage pulse noise type : NAP series
Low leakage current type : NAM series
* The Noise Filter is recommended to connect with several devices.

- ① Series name
- ② Output wattage
- ③ Universal input
- ④ Output voltage
- ⑤ Optional
- C : with Coating
- G : Low leakage current
- J2 : Mini terminal block
- R : with Remote ON/OFF
- S : with Chassis
- SN : with Chassis & cover
- Y : with Potentiometer

MODEL	LEA150F-3R3-Y	LEA150F-5	LEA150F-9	LEA150F-12	LEA150F-15	LEA150F-18	LEA150F-24	LEA150F-24-H	LEA150F-30	LEA150F-48
MAX OUTPUT WATTAGE[W]	99	150	153	150	150	153	151.2	151.2	150	153.6
DC OUTPUT	*5 3.3V 30A	5V 30A	9V 17A	12V 12.5A	15V 10A	18V 8.5A	24V 6.3A	24V 6.3(7.5)A	30V 5A	48V 3.2A

SPECIFICATIONS

	MODEL	LEA150F-3R3-Y	LEA150F-5	LEA150F-9	LEA150F-12	LEA150F-15	LEA150F-18	LEA150F-24	LEA150F-24-H	LEA150F-30	LEA150F-48	
INPUT	VOLTAGE[V]	AC85 - 264 1 φ or DC120 - 370										
	CURRENT[A]	ACIN 100V	1.4	2.0typ								
		ACIN 200V	0.7	1.0typ								
	FREQUENCY[Hz]	50/60 (47 - 63) or DC										
	EFFICIENCY[%]	ACIN 100V	71typ	76typ	79typ	78typ	80typ	81typ	81typ	81typ	84typ	84typ
		ACIN 200V	74typ	79typ	82typ	81typ	83typ	84typ	84typ	84typ	87typ	87typ
	POWER FACTOR	ACIN 100V	0.98typ	0.99typ								
ACIN 200V		0.91typ	0.94typ									
INRUSH CURRENT[A]	ACIN 100V	15typ (Io=100%) (At cold start) (Ta=25°C)										
	ACIN 200V	30typ (Io=100%) (At cold start) (Ta=25°C)										
LEAKAGE CURRENT[mA]	0.75max (60Hz, According to IEC60950 and DEN-AN)											
OUTPUT	VOLTAGE[V]	3.3	5	9	12	15	18	24	24	30	48	
	CURRENT[A]	*1 30	30	17	12.5	10	8.5	6.3	6.3 (Peak 7.5)	5	3.2	
	LINE REGULATION[mV]	20max	20max	36max	48max	60max	72max	96max	96max	120max	192max	
	LOAD REGULATION[mV]	40max	40max	100max	100max	120max	120max	150max	150max	180max	300max	
	RIPPLE[mVp-p]	0 to +50°C *2	80max	80max	120max	120max	120max	120max	150max	150max	180max	150max
		-10 - 0°C *2	140max	140max	160max	160max	160max	160max	160max	160max	160max	200max
	RIPPLE NOISE[mVp-p]	0 to +50°C *2	120max	120max	150max	150max	150max	150max	150max	150max	150max	350max
		-10 - 0°C *2	160max	160max	180max	180max	180max	180max	180max	180max	180max	400max
	TEMPERATURE REGULATION[mV]	0 to +50°C	50max	50max	90max	120max	150max	180max	240max	240max	300max	480max
		-10 to +50°C	60max	60max	120max	150max	180max	200max	290max	290max	360max	600max
	DRIFT[mV]	*3 20max	20max	36max	48max	60max	72max	96max	96max	120max	192max	
	START-UP TIME[ms]	500max (ACIN 100V, Io=100%)										
	HOLD-UP TIME[ms]	20typ (Io=100%)										
	OUTPUT VOLTAGE ADJUSTMENT RANGE[V]	2.85 - 3.6	Fixed (*Y which can be adjusted the output is available as optional: ±10%)									
OUTPUT VOLTAGE SETTING[V]	3.25 - 3.35	4.9 - 5.3	8.6 - 9.4	11.5 - 12.5	14.4 - 15.6	17.3 - 18.7	23.0 - 25.0	23.0 - 25.0	28.5 - 31.5	46.0 - 50.0		
PROTECTION CIRCUIT AND OTHERS	OVERCURRENT PROTECTION	Works over 105% of rating (works over 105% of peak current at option -H) and recovers automatically										
	OVERVOLTAGE PROTECTION	4.00 - 5.25V Works at 115 - 140% of rating										
	OPERATING INDICATION	Not provided										
	REMOTE SENSING	Not provided										
REMOTE ON/OFF	Option (Refer to Instruction Manual)											
ISOLATION	INPUT-OUTPUT · RC	*4 AC3.000V 1minute, Cutoff current = 10mA, DC500V 50MΩ min (At Room Temperature)										
	INPUT-FG	AC2.000V 1minute, Cutoff current = 10mA, DC500V 50MΩ min (At Room Temperature)										
	OUTPUT · RC-FG	*4 AC500V 1minute, Cutoff current = 100mA, DC500V 50MΩ min (At Room Temperature)										
	OUTPUT-RC	*4 AC100V 1minute, Cutoff current = 100mA, DC100V 10MΩ min (At Room Temperature)										
ENVIRONMENT	OPERATING TEMP., HUMID. AND ALTITUDE	-10 to +60°C, 20 - 90%RH (Non condensing) (Refer to DERATING CURVE), 3,000m (10,000feet) max										
	STORAGE TEMP., HUMID. AND ALTITUDE	-20 to +75°C, 20 - 90%RH (Non condensing), 9,000m (30,000feet) max										
	VIBRATION	10 - 55Hz, 19.6m/s ² (2G), 3minutes period, 60minutes each along X, Y and Z axis										
	IMPACT	196.1m/s ² (20G), 11ms, once each X, Y and Z axis										
SAFETY AND NOISE REGULATIONS	AGENCY APPROVALS	UL60950-1, C-UL, EN60950-1, EN50178 Complies with DEN-AN and IEC60950-1 (At only AC input)										
	CONDUCTED NOISE	Complies with FCC-B, CISPR22-B, EN55022-B, VCCI-B										
	HARMONIC ATTENUATOR	Complies with IEC61000-3-2										
OTHERS	CASE SIZE/WEIGHT	75 x 40 x 222mm (W x H x D) /500g max (without chassis and cover)										
	COOLING METHOD	Convection										

*1 Peak load for 10 sec. or less is acceptable if the total wattage is less than the rated wattage.
 *2 This is the value that measured on measuring board with capacitor of 22 μF within 150mm from output terminal.
 Measured by 20MHz oscilloscope or Ripple-Noise meter (Equivalent to KEISOKU-GIKEN: RM101).
 *3 Drift is the change in DC output for an eight hour period after a half-hour warm-up at 25°C,

with the input voltage held constant at the rated input/output.
 *4 Applicable when remote control (optional) is added.
 *5 (): peak current.
 * Parallel operation with other model is not possible.
 * Derating is required when operated with chassis and cover.

External view



I / O Connector	Mating Connector	Terminal
CN1	B3P5-VH	VHR-5N
CN2	B6P-VH	VHR-6N
CN3	B7P-VH	VHR-7N
CN4	B2B-XH-A	XHP-2

(PIN CONNECTION)

Pin No.	Input
1	AC(L)
2	
3	AC(N)
4	
5	FG

Pin No.	Output
1~6	+V
1~7	-V

(Optional)

Pin No.	Remote ON/OFF
1	RC(+)
2	RC(-)

※Keep drawing current per pin below 5A for CN2, CN3

- ※Weight: 500g or less (Without chassis and cover)
- ※Tolerance: ±1
- ※Dimensions in mm.
- ※PCB Material: Glass composite (CEM3)
- ※Chassis and cover is optional.
- ※Chassis and cover is not available to remote ON/OFF unit.
- ※Mounting torque: 1.5N · m(16kgf · cm)max

LEA

Performance data

RISE TIME & FALL TIME (LEA150F-5)

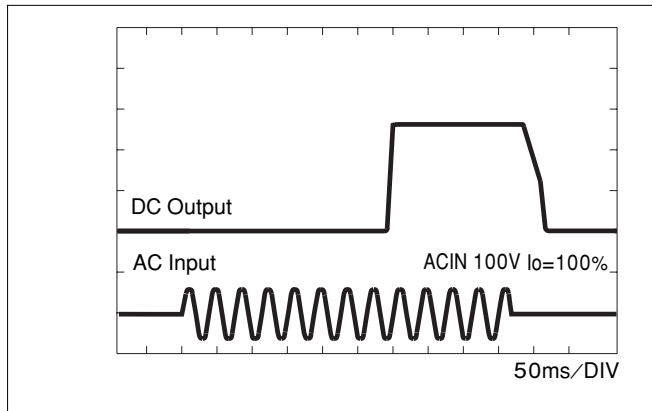

EFFICIENCY (LEA150F-5)



INPUT HARMONIC CURRENT (LEA150F-5)

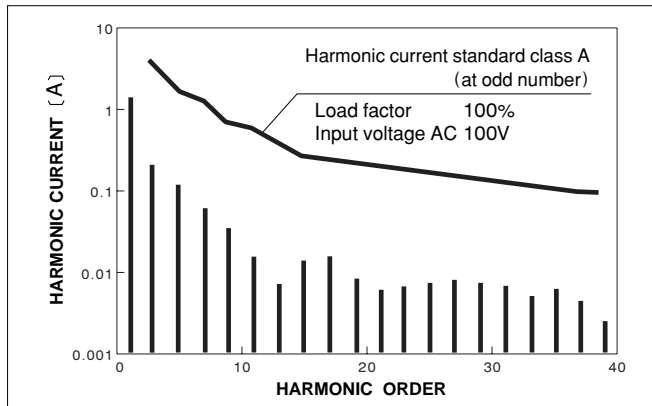

INPUT HARMONIC CURRENT (LEA150F-5)



Distribution:

RSG Electronic Components GmbH ▪ Spremlinger Landstr. 115 ▪ D-63069 Offenbach/Germany
Tel. +49 69 984047-0 ▪ Fax +49 69 984047-77 ▪ info@rsg-electronic.de ▪ www.rsg-electronic.de

Änderungen vorbehalten / subject to change without notice

Компания «Океан Электроники» предлагает заключение долгосрочных отношений при поставках импортных электронных компонентов на взаимовыгодных условиях!

Наши преимущества:

- Поставка оригинальных импортных электронных компонентов напрямую с производств Америки, Европы и Азии, а так же с крупнейших складов мира;
- Широкая линейка поставок активных и пассивных импортных электронных компонентов (более 30 млн. наименований);
- Поставка сложных, дефицитных, либо снятых с производства позиций;
- Оперативные сроки поставки под заказ (от 5 рабочих дней);
- Экспресс доставка в любую точку России;
- Помощь Конструкторского Отдела и консультации квалифицированных инженеров;
- Техническая поддержка проекта, помощь в подборе аналогов, поставка прототипов;
- Поставка электронных компонентов под контролем ВП;
- Система менеджмента качества сертифицирована по Международному стандарту ISO 9001;
- При необходимости вся продукция военного и аэрокосмического назначения проходит испытания и сертификацию в лаборатории (по согласованию с заказчиком);
- Поставка специализированных компонентов военного и аэрокосмического уровня качества (Xilinx, Altera, Analog Devices, Intersil, Interpoint, Microsemi, Actel, Aeroflex, Peregrine, VPT, Syfer, Eurofarad, Texas Instruments, MS Kennedy, Miteq, Cobham, E2V, MA-COM, Hittite, Mini-Circuits, General Dynamics и др.);

Компания «Океан Электроники» является официальным дистрибьютором и эксклюзивным представителем в России одного из крупнейших производителей разъемов военного и аэрокосмического назначения «JONHON», а так же официальным дистрибьютором и эксклюзивным представителем в России производителя высокотехнологичных и надежных решений для передачи СВЧ сигналов «FORSTAR».



JONHON

«JONHON» (основан в 1970 г.)

Разъемы специального, военного и аэрокосмического назначения:

(Применяются в военной, авиационной, аэрокосмической, морской, железнодорожной, горно- и нефтедобывающей отраслях промышленности)

«FORSTAR» (основан в 1998 г.)

ВЧ соединители, коаксиальные кабели, кабельные сборки и микроволновые компоненты:

(Применяются в телекоммуникациях гражданского и специального назначения, в средствах связи, РЛС, а так же военной, авиационной и аэрокосмической отраслях промышленности).



Телефон: 8 (812) 309-75-97 (многоканальный)

Факс: 8 (812) 320-03-32

Электронная почта: ocean@oceanchips.ru

Web: <http://oceanchips.ru/>

Адрес: 198099, г. Санкт-Петербург, ул. Калинина, д. 2, корп. 4, лит. А