

**ASYMMETRICAL-BIDIRECTIONAL THYRISTOR
OVERVOLTAGE PROTECTOR**



TISP4A250H3BJ Overvoltage Protector

RING Line Protection for:

- LCAS (Line Card Access Switch) such as Le75181, Le75183 and Le75282

Voltages Optimized for:

- Battery-Backed Ringing Circuits
 Maximum Ringing a.c.104 Vrms
 Maximum Battery Voltage -52 V

Device Name	V _{DRM} V	V _(BO) V
TISP4A250H3BJ	+100	+125
	-200	-250

Rated for International Surge Wave Shapes

Wave Shape	Standard	I _{PPSM} A
2/10	GR-1089-CORE	500
8/20	IEC 61000-4-5	300
10/160	TIA-968-A	250
10/700	ITU-T K.20/21/45	200
10/560	TIA-968-A	160
10/1000	GR-1089-CORE	100

SMB Package (Top View)

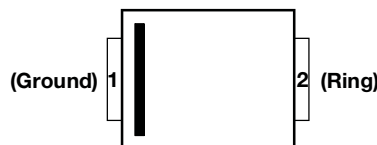

Terminal typical application names shown in parenthesis

MD-SMB-006-a

Device Symbol

(Ring)



(Ground)

SD-TISP4A-001-a



.....UL Recognized Component

How To Order

Device	Package	Carrier	Order As	Marking Code	Standard Quantity
TISP4A250H3BJ	SMB	Embossed Tape Reeled	TISP4A250H3BJR-S	4A250H	3000

Description

The TISP4A250H3BJ is an asymmetrical bidirectional overvoltage protector. It is designed to limit the peak voltages on the Ring line terminal of the LCAS (Line Card Access Switch) such as Le75181, Le75183 and Le75282. The TISP4A250H3BJ must be connected with bar-indexed terminal 1 to the protective Ground, and terminal 2 to the Ring conductor.

The TISP4A250H3BJ voltages are chosen to give adequate LCAS ring line terminal protection for all switch conditions. The most potentially stressful condition is low level power cross when the LCAS switches are closed. Under this condition, the TISP4A250H3BJ limits the voltage and corresponding LCAS dissipation until the LCAS thermal trip operates and opens the switches.

Under open-circuit ringing conditions, the line Ring conductor will have high peak voltages. For battery backed ringing, the Ring conductor will have a larger peak negative voltage than positive, i.e. the peak voltages are asymmetric. The TISP4A250H3BJ has a similar voltage asymmetry and will allow the maximum possible ringing voltage, while giving the most effective protection. On a connected line, the Tip conductor will have much smaller voltage levels than the open-circuit Ring conductor values. Here a TISP4xxxH3BJ series symmetrical voltage protector gives adequate protection.

Overvoltages are initially clipped by breakdown clamping. If sufficient current is available from the overvoltage, the breakdown voltage will rise to the breakover level, which causes the device to switch into a low-voltage on-state condition. This switching action removes the high voltage stress from the following circuitry and causes the current resulting from the overvoltage to be safely diverted through the protector. The high holding (switch off) current helps prevent d.c. latchup as the diverted current subsides.

*RoHS Directive 2002/95/EC Jan 27 2003 including Annex
 NOVEMBER 2006 - REVISED MAY 2007
 Specifications are subject to change without notice.
 Customers should verify actual device performance in their specific applications.

TISP4A250H3BJ Overvoltage Protector

BOURNS®

Absolute Maximum Ratings, $T_A = 25\text{ }^\circ\text{C}$ (Unless Otherwise Noted)

Rating	Symbol	Value	Unit
Repetitive peak off-state voltage (see Note 1)	V_{DRM}	+100 -200	V
Non-repetitive peak impulse current (see Notes 2 and 3) 2/10 μs (GR-1089-CORE, 2/10 μs voltage wave shape) 8/20 μs (IEC 61000-4-5, 1.2/50 μs voltage, 8/20 μs current combination wave generator) 10/160 μs (TIA-968-A, 10/160 μs voltage wave shape) 5/310 μs (ITU-T K.44, 10/700 μs voltage wave shape used in K.20/21/45) 5/320 μs (TIA-968-A, 9/720 μs voltage wave shape) 10/560 μs (TIA-968-A, 10/560 μs voltage wave shape) 10/1000 μs (GR-1089-CORE, 10/1000 μs voltage wave shape)	I_{PPSM}	± 500 ± 300 ± 250 ± 200 ± 200 ± 160 ± 100	A
Non-repetitive peak on-state current (see Notes 2, 3 and 4) 20 ms, 50 Hz (full sine wave) 16.7 ms, 60 Hz (full sine wave) 1000 s, 50 Hz or 60 Hz a.c.	I_{TSM}	55 60 2.2	A
Initial rate of rise of on-state current, exponential current ramp. Maximum ramp value < 200 A	di_{T}/dt	400	A/ μs
Junction temperature	T_{J}	-40 to +150	$^\circ\text{C}$
Storage temperature range	T_{stg}	-65 to +150	$^\circ\text{C}$

NOTES: 1. See Figure 6 for voltages at other temperatures.

2. Initially the device must be in thermal equilibrium with $T_{\text{J}} = 25\text{ }^\circ\text{C}$.

3. The surge may be repeated after the device returns to its initial conditions.

4. EIA/JESD51-2 environment and EIA/JESD51-3 PCB with standard footprint dimensions connected with 5 A rated printed wiring track widths. See Figure 5 for the current ratings at other durations. Derate current values at $-0.61\text{ }^\circ\text{C}$ for ambient temperatures above $25\text{ }^\circ\text{C}$.

Overload Ratings, $T_A = 25\text{ }^\circ\text{C}$ (Unless Otherwise Noted)

Rating	Symbol	Value	Unit
Maximum overload on-state current without open circuit, 50 Hz or 60 Hz a.c. (see note 5) 0.03 s 0.07 s 1.6 s 5.0 s 1000 s	$I_{\text{T(OV)M}}$	60 40 8 7 2.2	A rms

NOTE: 5. Peak overload on-state current during a.c. power cross tests of GR-1089-CORE and UL 1950/60950. These electrical stress levels may damage the TISP4A250H3BJ silicon die. After test, the pass criterion is either that the device is functional or, if it is faulty, that it has a short-circuit fault mode. In the short-circuit fault mode, the following equipment is protected as the device is a permanent short across the line. The equipment would be unprotected if an open-circuit fault mode developed.

TISP4A250H3BJ Overvoltage Protector

BOURNS®

Electrical Characteristics, $T_A = 25\text{ °C}$ (Unless Otherwise Noted)

Parameter	Test Conditions	Min	Typ	Max	Unit
I_{DRM} Repetitive peak off-state current	$V_D = V_{DRM}$ $T_A = 25\text{ °C}$ $T_A = 85\text{ °C}$			± 5 ± 10	μA
$V_{(BO)}$ Breakover voltage	$dv/dt = \pm 250\text{ V/ms}$, $R_{SOURCE} = 300\ \Omega$			+125 -250	V
$I_{(BO)}$ Breakover current	$dv/dt = \pm 250\text{ V/ms}$, $R_{SOURCE} = 300\ \Omega$	± 150		± 600	mA
V_T On-state voltage	$I_T = \pm 5\text{ A}$, $t_w = 100\ \mu\text{s}$			± 3	V
I_H Holding current	$I_T = \pm 5\text{ A}$, $di/dt = \pm 30\text{ mA/ms}$	± 150		± 600	mA
dv/dt Critical rate of rise of off-state voltage	Linear voltage ramp Maximum ramp value $< 0.85V_{DRM}$	± 5			kV/ μs
C_O Off-state capacitance	$f = 1\text{ MHz}$, $V_d = 1\text{ V rms}$ $V_D = 2\text{ V}$			72	pF

Thermal Characteristics, $T_A = 25\text{ °C}$ (Unless Otherwise Noted)

Parameter	Test Conditions	Min	Typ	Max	Unit
$R_{\theta JA}$ Junction to ambient thermal resistance	EIA/JESD51-3 PCB, $I_T = I_{TSM(1000)}$ (see Note 6)			113	$^{\circ}\text{C/W}$
	265 mm x 210 mm populated line card, 4-layer PCB, $I_T = I_{TSM(1000)}$		50		

NOTE: 6. EIA/JESD51-2 environment and PCB has standard footprint dimensions connected with 5 A rated printed wiring track widths.

Parameter Measurement Information

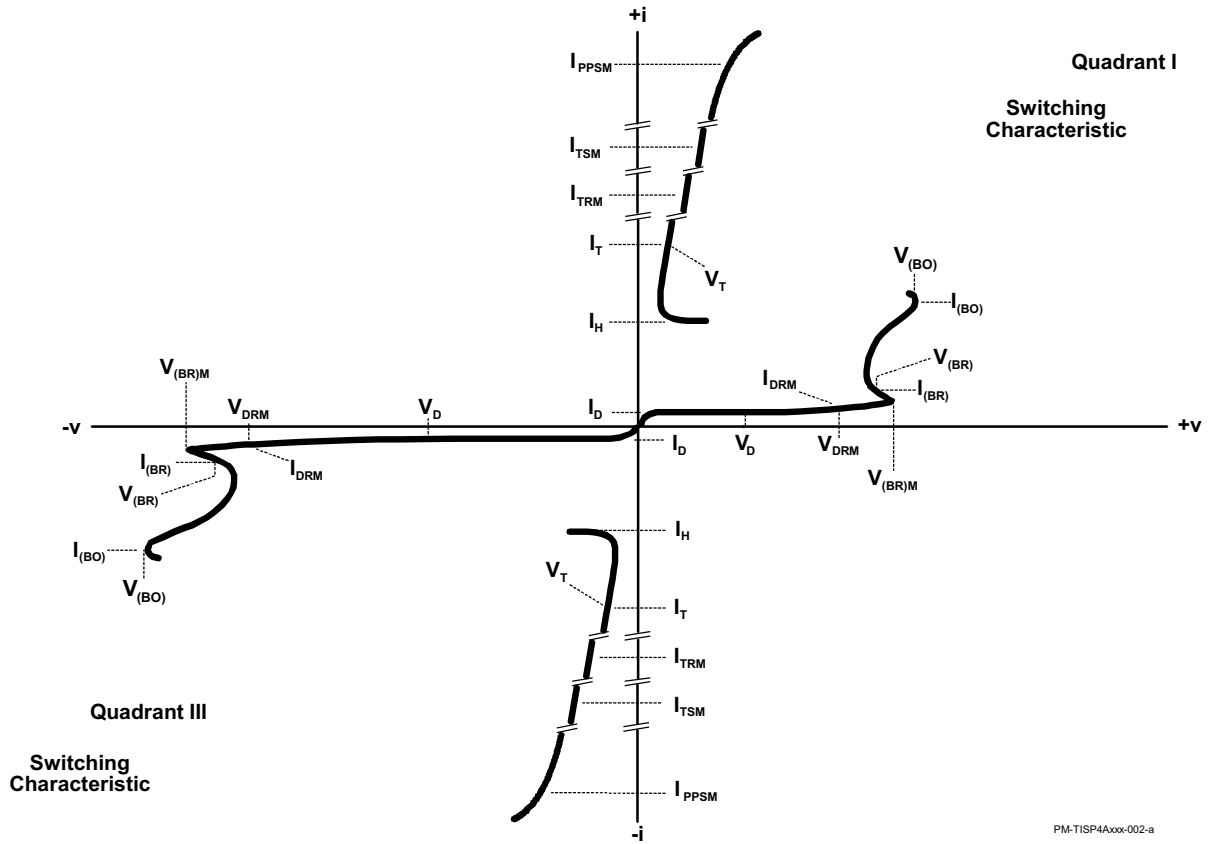

PM-TISP4Axxx-002-a

**Figure 1. Voltage-Current Characteristic for the Ring and Ground Terminals
All Measurements are Referenced to the Ground Terminal**

Typical Characteristics

**OFF-STATE CURRENT
vs
JUNCTION TEMPERATURE**

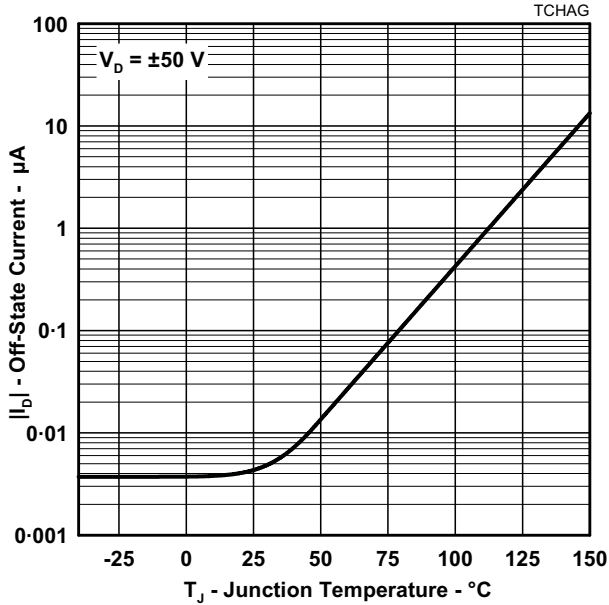

Figure 2.

**NORMALIZED BREAKOVER VOLTAGE
vs
JUNCTION TEMPERATURE**

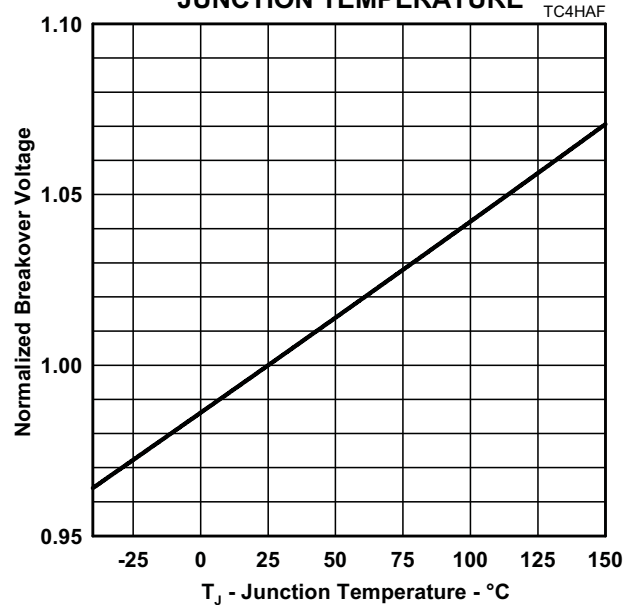

Figure 3.

**NORMALIZED HOLDING CURRENT
vs
JUNCTION TEMPERATURE**

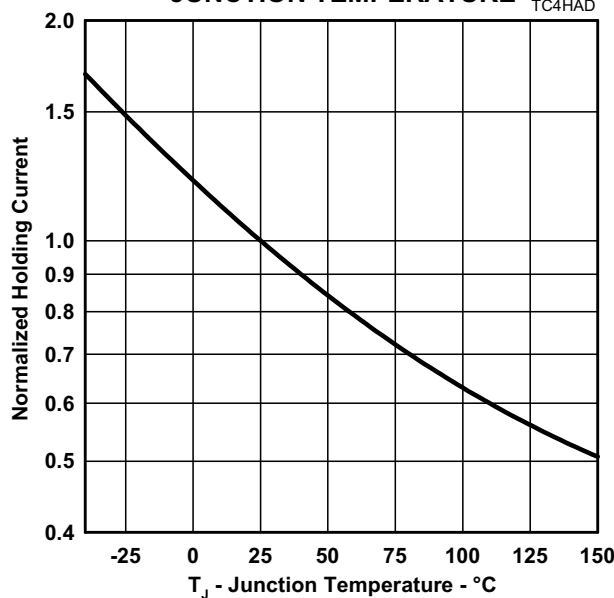

Figure 4.

Rating and Thermal Information

NON-REPETITIVE PEAK ON-STATE CURRENT vs CURRENT DURATION

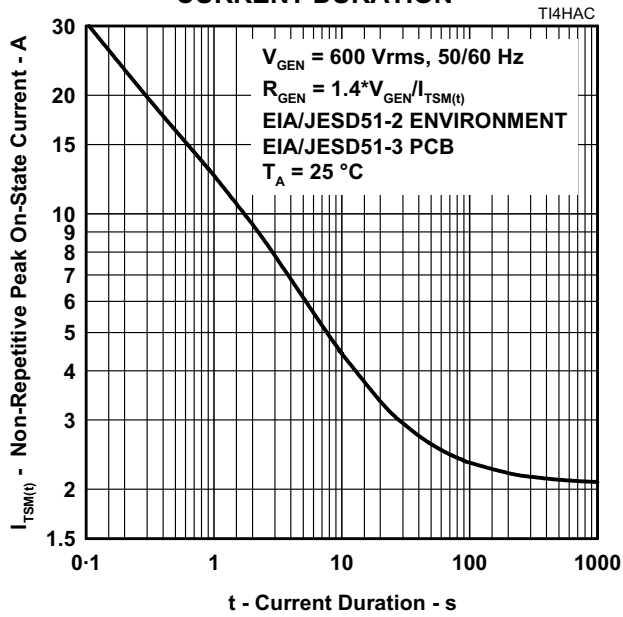

Figure 5.

V_{DRM} DERATING FACTOR vs MINIMUM AMBIENT TEMPERATURE

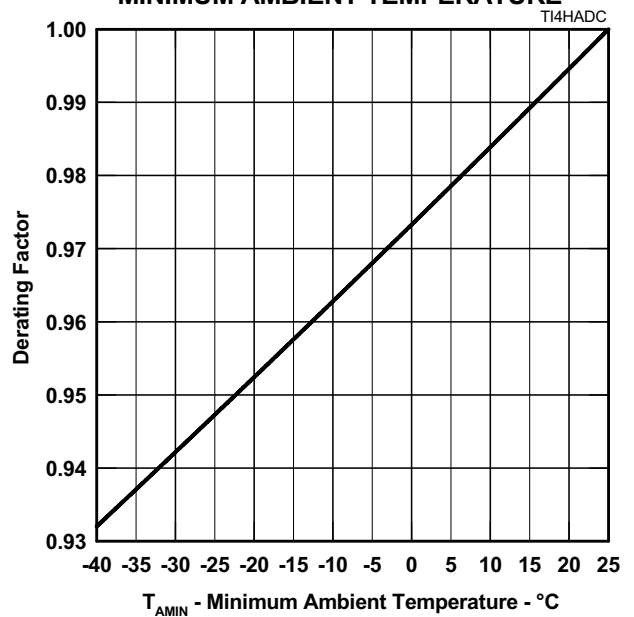
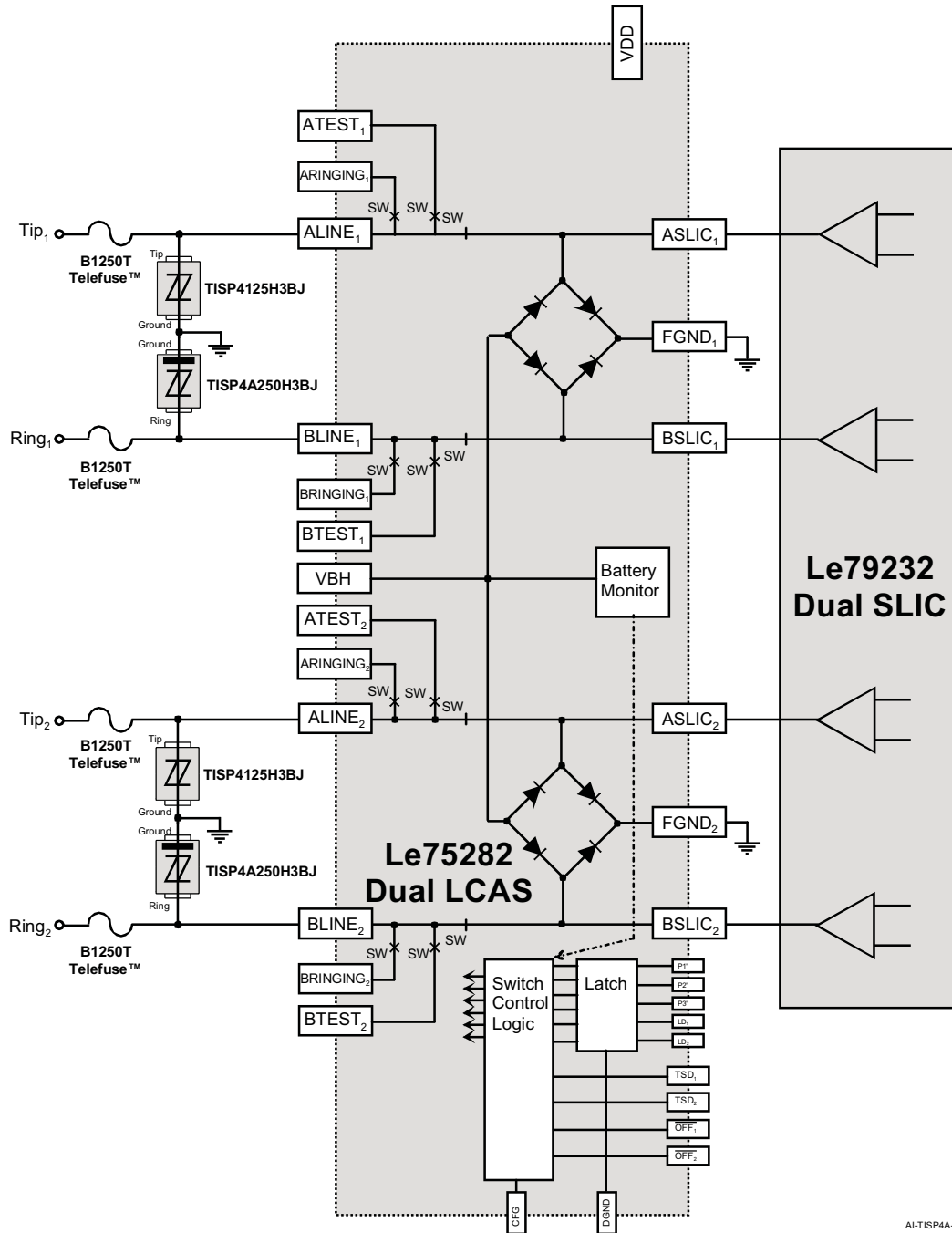

Figure 6.

TISP4A250H3BJ Overvoltage Protector

BOURNS®

Applications Information



AI-TISP4A-001-a

Figure 7. Typical Application Circuit

Bourns Sales Offices

Region	Phone	Fax
The Americas:	+1-951-781-5500	+1-951-781-5700
Europe:	+41-41-7685555	+41-41-7685510
Asia-Pacific:	+886-2-25624117	+886-2-25624116

Technical Assistance

Region	Phone	Fax
The Americas:	+1-951-781-5500	+1-951-781-5700
Europe:	+41-41-7685555	+41-41-7685510
Asia-Pacific:	+886-2-25624117	+886-2-25624116

www.bourns.com

Bourns® products are available through an extensive network of manufacturer's representatives, agents and distributors. To obtain technical applications assistance, a quotation, or to place an order, contact a Bourns representative in your area.



Reliable Electronic Solutions

Компания «Океан Электроники» предлагает заключение долгосрочных отношений при поставках импортных электронных компонентов на взаимовыгодных условиях!

Наши преимущества:

- Поставка оригинальных импортных электронных компонентов напрямую с производств Америки, Европы и Азии, а так же с крупнейших складов мира;
- Широкая линейка поставок активных и пассивных импортных электронных компонентов (более 30 млн. наименований);
- Поставка сложных, дефицитных, либо снятых с производства позиций;
- Оперативные сроки поставки под заказ (от 5 рабочих дней);
- Экспресс доставка в любую точку России;
- Помощь Конструкторского Отдела и консультации квалифицированных инженеров;
- Техническая поддержка проекта, помощь в подборе аналогов, поставка прототипов;
- Поставка электронных компонентов под контролем ВП;
- Система менеджмента качества сертифицирована по Международному стандарту ISO 9001;
- При необходимости вся продукция военного и аэрокосмического назначения проходит испытания и сертификацию в лаборатории (по согласованию с заказчиком);
- Поставка специализированных компонентов военного и аэрокосмического уровня качества (Xilinx, Altera, Analog Devices, Intersil, Interpoint, Microsemi, Actel, Aeroflex, Peregrine, VPT, Syfer, Eurofarad, Texas Instruments, MS Kennedy, Miteq, Cobham, E2V, MA-COM, Hittite, Mini-Circuits, General Dynamics и др.);

Компания «Океан Электроники» является официальным дистрибьютором и эксклюзивным представителем в России одного из крупнейших производителей разъемов военного и аэрокосмического назначения «JONHON», а так же официальным дистрибьютором и эксклюзивным представителем в России производителя высокотехнологичных и надежных решений для передачи СВЧ сигналов «FORSTAR».



JONHON

«JONHON» (основан в 1970 г.)

Разъемы специального, военного и аэрокосмического назначения:

(Применяются в военной, авиационной, аэрокосмической, морской, железнодорожной, горно- и нефтедобывающей отраслях промышленности)

«FORSTAR» (основан в 1998 г.)

ВЧ соединители, коаксиальные кабели, кабельные сборки и микроволновые компоненты:

(Применяются в телекоммуникациях гражданского и специального назначения, в средствах связи, РЛС, а так же военной, авиационной и аэрокосмической отраслях промышленности).



Телефон: 8 (812) 309-75-97 (многоканальный)

Факс: 8 (812) 320-03-32

Электронная почта: ocean@oceanchips.ru

Web: <http://oceanchips.ru/>

Адрес: 198099, г. Санкт-Петербург, ул. Калинина, д. 2, корп. 4, лит. А