

Electroformed Probe Pins

XP3B

Highly Reliable Electroformed Probe Pins. Outer spring type.

- Plunger structure to ensure stable contact.
- High durability due to the smooth end surfaces achieved with electroforming.



Feature

●Plunger structure to ensure stable contact.

Standard Probe Pin

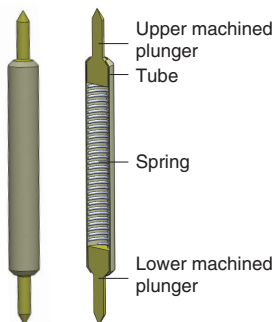

(Cross-section diagram)

Conductive Path
 Upper plunger
 ⇒ Tube
 ⇒ Lower plunger

Electroformed Probe Pin

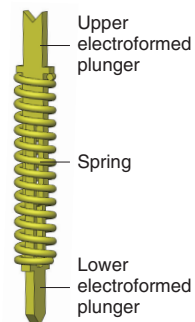

Conductive Path
 Upper plunger
 ⇒ Lower plunger

●Plunger structure ensures stable and constant plunger contact.

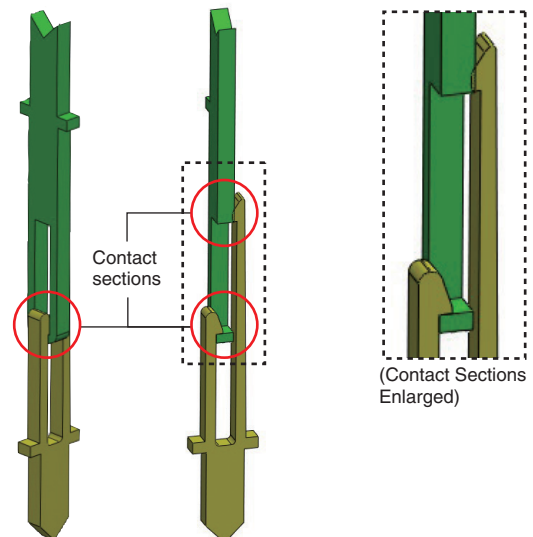

●Plunger Tip Shapes.

Plunger tip shapes other than those shown below can also be manufactured.

D	R	S

Usage Example

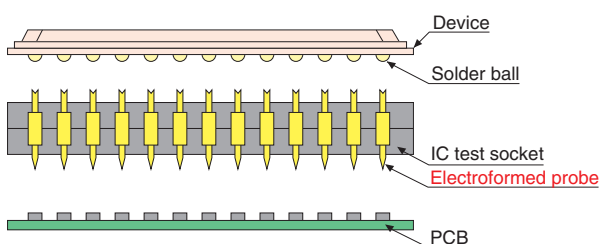

XP3B

Model Number List

XP3B-123-456-7-8/□



1	2		3		4		5		6	7	8			
Series	Diameter		Overall length		Upper contact length		Lower contact length		Plating specification	Upper contact shape	Lower contact shape			
XP3B	38	0.38 dia.	29	2.85 mm	50	0.5 mm	50	0.5 mm	1	Gold	D		D	
											S		S	
	30	0.30 dia.	30	0.3 mm	15	0.15 mm	R				R			
							S				S			
30 <i>NEW</i>	0.30 dia.	12	1.18 mm	30	0.3 mm	15	0.15 mm							

Ratings and Specifications

Diameter	0.38 dia.	0.30 dia.	0.30 dia.
Model	XP3B-3829-5050-1-□/□	XP3B-3029-5050-1-□/□	XP3B-3012-3015-1-□/□
Rated current	2A		2A
Contact force	33 gf	25 gf	8 gf
Recommended stroke	0.4 mm		0.2 mm
Maximum stroke	0.5 mm		0.25 mm
Contact resistance	50 mΩ max.	60 mΩ max.	100 mΩ max.
Mechanical durability	1,000,000 operations min.		

Materials and Finish

Plunger	Nickel alloy/gold plating
Spring	SWP/gold plating

XP3B-38 0.38 Diameter for 0.5-mm Pitch

■ Dimensions

(Unit: mm)



■ Recommended Mounting Dimensions

(Unit: mm)



■ Ordering Information

Upper contact shape	Lower contact shape	Model	Minimum ordering quantity (pieces)
D	D	XP3B-3829-5050-1-D/D	50
	R	XP3B-3829-5050-1-D/R	
	S	XP3B-3829-5050-1-D/S	
R	R	XP3B-3829-5050-1-R/R	
S	R	XP3B-3829-5050-1-S/R	
	S	XP3B-3829-5050-1-S/S	

Note: Either upper or lower contact can be set for contact with the inspection target.

XP3B

XP3B-30 0.30 Diameter for 0.4-mm Pitch

■Dimensions (Unit: mm)

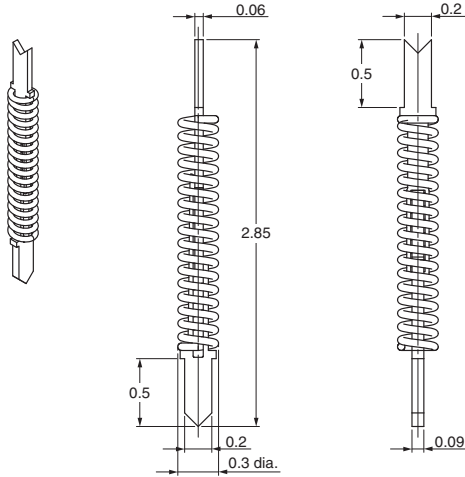

■Recommended Mounting Dimensions (Unit: mm)



■Ordering Information

Upper contact shape	Lower contact shape	Model	Minimum ordering quantity (pieces)
D	D	XP3B-3029-5050-1-D/D	50
	R	XP3B-3029-5050-1-D/R	
	S	XP3B-3029-5050-1-D/S	
R	D	XP3B-3029-5050-1-R/D	
	R	XP3B-3029-5050-1-R/R	
	S	XP3B-3029-5050-1-R/S	
S	D	XP3B-3029-5050-1-S/D	
	R	XP3B-3029-5050-1-S/R	
	S	XP3B-3029-5050-1-S/S	

Note: Set the lower contact for contact with the inspection target.

XP3B-3012 0.30 Diameter for High-frequency Applications **NEW**

■Dimensions



(Unit: mm)

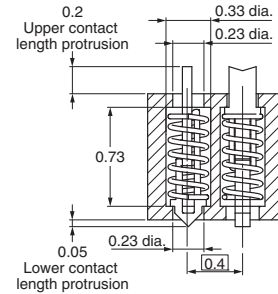

■Recommended Mounting Dimensions (Unit: mm)



■Ordering Information

Upper contact shape		Lower contact shape		Model	Minimum ordering quantity (pieces)
D		S		XP3B-3012-3015-1-D/S NEW	50
S				XP3B-3012-3015-1-S/S NEW	

Note: Set the lower contact for contact with the inspection target.

Insertion Loss

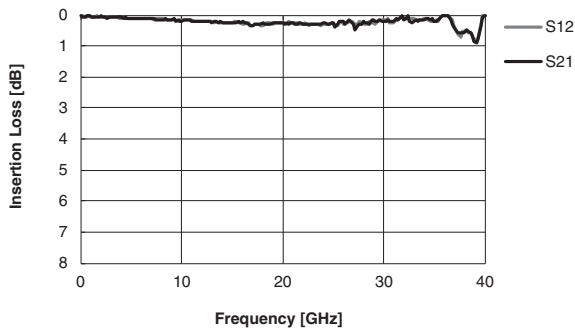

Return loss

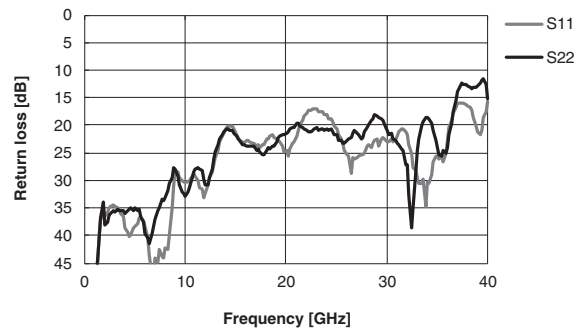

■ Safety Precautions

Precautions for Correct Use

● General Environmental Conditions

- (1) Use the Probe Pins in an ambient atmosphere that does not contain dust, dirt, corrosive gas, or oil so that the Probe Pins do not get contaminated.

● Stroke Conditions

- (1) Apply a load to the Probe Pins only in the axial direction. Never apply a lateral load.
- (2) The life of the Probe Pins will be drastically reduced if the recommended stroke is exceeded.

● Current Application Conditions

- (1) Apply current when the Probe Pins are stationary after they come into contact with the target at the recommended stroke position.
- (2) If a current is applied during the stroke, at a position other than the recommended stroke, or when the Probe Pins are not in contact with the target, the life of the Probe Pins will be drastically reduced.
- (3) The catalog value of the carrying capacity may not be met due to Probe Pin deterioration or other factors. Allow sufficient leeway when you design the actual application.

● Voltage Application Conditions

- (1) Apply voltage when the Probe Pins are stationary after they come into contact with the target at the recommended stroke position.
- (2) Do not apply a voltage when the Probe Pins are not in contact with the target. The Probe Pins will be damaged due to discharge immediately before they come into contact.
- (3) When a high voltage is applied to the contact probe, strictly observe the current and voltage application conditions. Also, take measures to prevent discharge or other large instantaneous currents.

● Carrying Capacity

- (1) The rated current that is given in the catalog is the maximum continuous current for 1 minute for inspection of gold pads under the conditions given on the left (general environment, recommended stroke, current application, and voltage application).

● Resistance

- (1) If a large current is applied, the resistance may increase due to deterioration of the contacts and internal components.
- (2) As the number of strokes increases, the resistance may increase due to deterioration of the contacts and internal components.

● Durability

- (1) The durability that is given in the catalog is a guideline for the number of times that the Probe Pins can be used without problems at 10 mA for gold pads under the conditions given on the left (general environment, recommended stroke, current application, and voltage application).
- (2) Depending on the operating environment and conditions, the Probe Pins may need to be replaced sooner than the specified limit in the datasheet due to increased resistance, reduced contact force, or other factors. Replace the Probe Pins as required by the actual application.

● Contact Force

- (1) If the current is increased, heat generated by the Probe Pins will reduce the contact force.

● Recommended Mounting Dimensions

- (1) The dimensions are reference values. Actual values will depend on the material and thickness of the resin plate.

● Handling Precautions

Observe the following precautions when you are handling the Probe Pins. Otherwise, the Probe Pins may be damaged.

- Do not apply excessive force to the contact sections of the electroformed plungers.
- Do not apply excessive force to the coil spring section.



- Application examples provided in this document are for reference only. In actual applications, confirm equipment functions and safety before using the product.
- Consult your OMRON representative before using the product under conditions which are not described in the manual or applying the product to nuclear control systems, railroad systems, aviation systems, vehicles, combustion systems, medical equipment, amusement machines, safety equipment, and other systems or equipment that may have a serious influence on lives and property if used improperly. Make sure that the ratings and performance characteristics of the product provide a margin of safety for the system or equipment, and be sure to provide the system or equipment with double safety mechanisms.

Note: Do not use this document to operate the Unit.

Mouser Electronics

Authorized Distributor

Click to View Pricing, Inventory, Delivery & Lifecycle Information:

Omron:

[XP3B-3029-5050-1-R/D](#) [XP3B-3029-5050-1-R/R](#) [XP3B-3029-5050-1-S/T](#) [XP3B-3029-5050-1-D/T](#) [XP3B-3829-5050-1-R/S](#) [XP3B-3829-5050-1-S/T](#) [XP3B-3029-5050-1-T/D](#) [XP3B-3029-5050-1-T/R](#) [XP3B-3829-5050-1-D/S](#) [XP3B-3029-5050-1-S/D](#) [XP3B-3029-5050-1-S/S](#) [XP3B-3829-5050-1-R/D](#) [XP3B-3029-5050-1-T/S](#) [XP3B-3029-5050-1-T/T](#) [XP3B-3829-5050-1-R/T](#) [XP3B-3829-5050-1-T/D](#) [XP3B-3829-5050-1-R/R](#) [XP3B-3829-5050-1-T/T](#) [XP3B-3029-5050-1-R/S](#) [XP3B-3829-5050-1-D/R](#) [XP3B-3029-5050-1-D/R](#) [XP3B-3029-5050-1-D/S](#) [XP3B-3829-5050-1-D/D](#) [XP3B-3829-5050-1-T/R](#) [XP3B-3829-5050-1-T/S](#) [XP3B-3029-5050-1-D/D](#) [XP3B-3829-5050-1-S/R](#) [XP3B-3829-5050-1-S/S](#) [XP3B-3829-5050-1-D/T](#) [XP3B-3029-5050-1-R/T](#) [XP3B-3029-5050-1-S/R](#) [XP3B-3829-5050-1-S/D](#)

Компания «Океан Электроники» предлагает заключение долгосрочных отношений при поставках импортных электронных компонентов на взаимовыгодных условиях!

Наши преимущества:

- Поставка оригинальных импортных электронных компонентов напрямую с производств Америки, Европы и Азии, а так же с крупнейших складов мира;
- Широкая линейка поставок активных и пассивных импортных электронных компонентов (более 30 млн. наименований);
- Поставка сложных, дефицитных, либо снятых с производства позиций;
- Оперативные сроки поставки под заказ (от 5 рабочих дней);
- Экспресс доставка в любую точку России;
- Помощь Конструкторского Отдела и консультации квалифицированных инженеров;
- Техническая поддержка проекта, помощь в подборе аналогов, поставка прототипов;
- Поставка электронных компонентов под контролем ВП;
- Система менеджмента качества сертифицирована по Международному стандарту ISO 9001;
- При необходимости вся продукция военного и аэрокосмического назначения проходит испытания и сертификацию в лаборатории (по согласованию с заказчиком);
- Поставка специализированных компонентов военного и аэрокосмического уровня качества (Xilinx, Altera, Analog Devices, Intersil, Interpoint, Microsemi, Actel, Aeroflex, Peregrine, VPT, Syfer, Eurofarad, Texas Instruments, MS Kennedy, Miteq, Cobham, E2V, MA-COM, Hittite, Mini-Circuits, General Dynamics и др.);

Компания «Океан Электроники» является официальным дистрибьютором и эксклюзивным представителем в России одного из крупнейших производителей разъемов военного и аэрокосмического назначения «JONHON», а так же официальным дистрибьютором и эксклюзивным представителем в России производителя высокотехнологичных и надежных решений для передачи СВЧ сигналов «FORSTAR».



JONHON

«JONHON» (основан в 1970 г.)

Разъемы специального, военного и аэрокосмического назначения:

(Применяются в военной, авиационной, аэрокосмической, морской, железнодорожной, горно- и нефтедобывающей отраслях промышленности)

«FORSTAR» (основан в 1998 г.)

ВЧ соединители, коаксиальные кабели, кабельные сборки и микроволновые компоненты:

(Применяются в телекоммуникациях гражданского и специального назначения, в средствах связи, РЛС, а так же военной, авиационной и аэрокосмической отраслях промышленности).



Телефон: 8 (812) 309-75-97 (многоканальный)

Факс: 8 (812) 320-03-32

Электронная почта: ocean@oceanchips.ru

Web: <http://oceanchips.ru/>

Адрес: 198099, г. Санкт-Петербург, ул. Калинина, д. 2, корп. 4, лит. А