

100mA Fixed Output for Automotive LDO Regulator

BDxxFA1MG-M

● General Description

BDxxFA1MG-M is an LDO regulator with output current capability of 0.1A and output voltage of 5.0V. The SSOP5 package can contribute to the downsizing of the set. As protective function to prevent IC from destruction, this chip has built-in over current protection circuit to protect the device when output is shorted and built-in thermal shutdown circuit to protect the IC during thermal over load conditions. This regulator can use ceramic capacitor, which have smaller size and longer life than other capacitors.

● Features

- AEC-Q100 Qualified (Note1)
 - Built-in high accuracy reference voltage circuit
 - Built-in Over current protection circuit (OCP)
 - Built-in Temperature protection circuit (TSD)
 - Zero μ A shutdown mode
 - Soft start function
- (Note1 Grade2)

● Package

(Typ) D(Typ) H(Max)
SSOP5 2.90mm x2.80mm x 1.25mm



● Key Specifications

- Input power supply voltage range: $V_{o+3.0V}$ to 25.0V
- Output voltage: 5.0V
- Output current: 0.1A (Max)
- Shutdown current: 0 μ A (Typ)
- Operating temperature range: -40°C to +105°C

● Typical Application Circuit

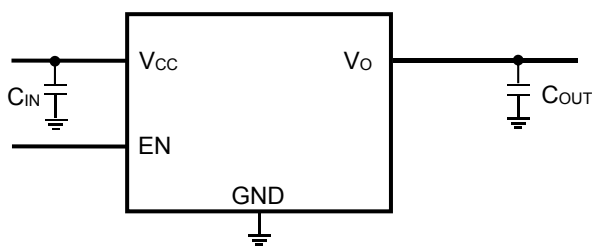

C_{IN} , C_{OUT} : Ceramic Capacitor

● Ordering Information

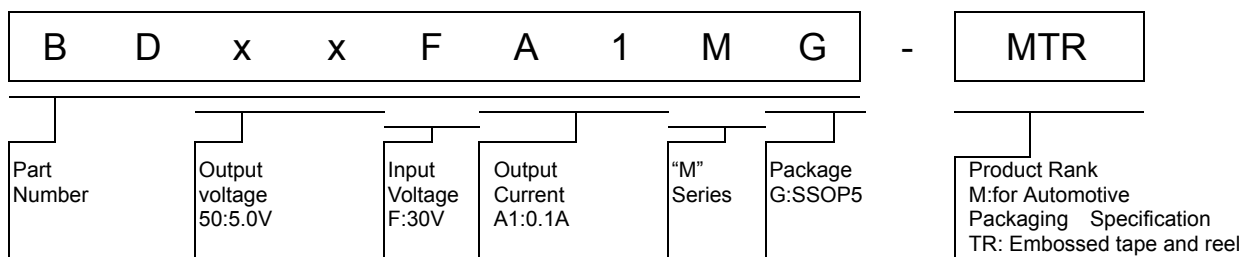

○ Product structure : Silicon monolithic integrated circuit ○ This product is not designed to have protection against radioactive rays.

● Block Diagram

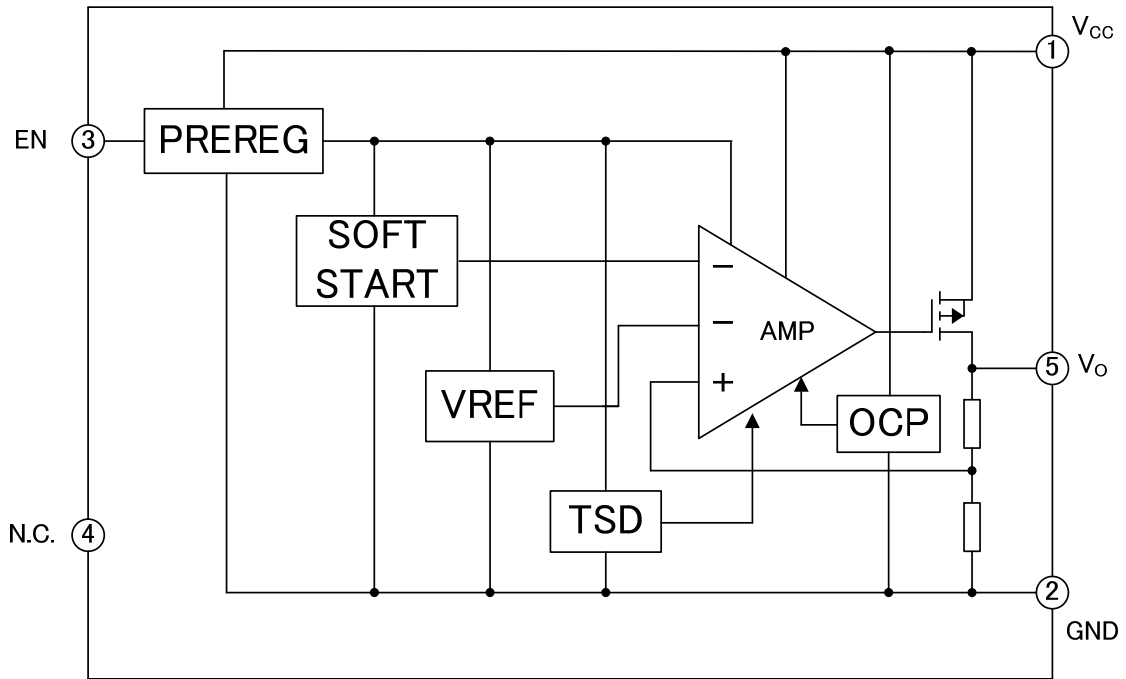

Figure 1. Block Diagram

Block	Function	Description
PREREG	Internal Power Supply	PREREG supplies voltage for internal circuit.
SOFT START	Soft Start	Soft Start controls Vo rising at start up.
VREF	Internal Reference Voltage	VREF generates reference voltage.
AMP	Error AMP	AMP amplifies electric signal and drives output power transistor.
OCP	Over Current Protection	When output current exceeds current ability, OCP restricts Output Current.
TSD	Thermal Shutdown	When Junction temperature rise and exceed Maximum junction temperature, TSD turns off Output power transistor.

● Pin Description

Pin No.	Pin name	Pin Function
1	V _{CC}	Input pin
2	GND	GND pin
3	EN	Enable pin
4	N.C. (Note1)	No Connection (Connect to GND or leave OPEN)
5	V _O	Output pin

(Note 1) N.C. Pin can be open since it is not connected inside of IC

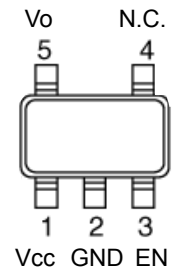

● Absolute Maximum Ratings

Parameter	Symbol	Limits	Unit
Power supply voltage	V _{CC}	-0.3 to +30.0 ^(Note1)	V
EN voltage	V _{EN}	-0.3 to +30.0	V
Operating temperature range	T _a	-40 to +105	°C
Storage temperature range	T _{stg}	-55 to +150	°C
Maximum junction temperature	T _{jmax}	+150	°C

(Note1) Not to exceed T_{jmax}.

Caution: Operating the IC over the absolute maximum ratings may damage the IC. The damage can either be a short circuit between pins or an open circuit between pins and the internal circuitry. Therefore, it is important to consider circuit protection measures, such as adding a fuse, in case the IC is operated over the absolute maximum ratings.

● Recommended Operating Conditions (T_a=-40°C to +105°C)

Parameter	Symbol	Min	Max	Unit
Input power supply voltage	V _{CC}	V _o +3.0	25.0	V
EN voltage	V _{EN}	0.0	25.0	V
Output current	I _o	0.0	0.1	A

● Recommended Operating Condition

Parameter	Symbol	Min	Typ	Max	Unit	Conditions
Input Capacitor	C _{IN}	1.0 ^(Note2)	2.2	-	μF	Ceramic capacitor recommended
Output Capacitor	C _{OUT}	1.0 ^(Note2)	2.2	-	μF	Ceramic capacitor recommended

(Note2) The minimum value of capacitor must meet this specification over full operating conditions. (Ex: Temperature, DC bias)

● Electrical Characteristics

(Unless otherwise specified, V_{CC}=10V, V_{EN}=3V, T_a=-40°C to +105°C, Typical values are defined at T_a = 25 °C)

Parameter	Symbol	Temp	Limits			Unit	Conditions
			Min	Typ	Max		
Circuit current at shutdown mode	I _{SD}	-40°C to +105°C	-	0	5	μA	V _{EN} =0V, OFF mode
Bias current	I _{CC}	25°C	-	300	450	μA	
		-40°C to +105°C	-	-	500		
Line Regulation	Reg.I	-40°C to +105°C	-1	+0.5	+1	%	V _{CC} =(V _o +3V)→25.0V
Load Regulation	Reg.I _o	-40°C to +105°C	-1.5	+0.5	+1.5	%	I _o =0→0.1A
Minimum dropout voltage	V _{CO}	-40°C to +105°C	-	1.5	3	V	I _o =0.1A
Output Voltage	V _o	25°C	V _o x 0.985	V _o	V _o x 1.015	V	I _o =0.1A
		-40°C to +105°C	V _o x 0.98	V _o	V _o x 1.02		
EN Low voltage	V _{EN} (Low)	-40°C to +105°C	0	-	0.8	V	
EN High voltage	V _{EN} (High)	-40°C to +105°C	2.4	-	25.0	V	
EN Bias current	I _{EN}	-40°C to +105°C	1	3	9	μA	

● Thermal Resistance (Note 1)

Parameter	Symbol	Thermal Resistance (Typ)		Unit
		1s ^(Note 3)	2s2p ^(Note 4)	
SSOP5				
Junction to Ambient	θ_{JA}	376.5	185.4	°C/W
Junction to Top Characterization Parameter ^(Note 2)	Ψ_{JT}	40	30	°C/W

(Note 1)Based on JESD51-2A(Still-Air).

(Note 2)The thermal characterization parameter to report the difference between junction temperature and the temperature at the top center of the outside surface of the component package.

(Note 3)Using a PCB board based on JESD51-3.

Layer Number of Measurement Board	Material	Board Size
Single	FR-4	114.3mm x 76.2mm x 1.57mmt

Top	
Copper Pattern	Thickness
Footprints and Traces	70μm

(Note 4)Using a PCB board based on JESD51-7.

Layer Number of Measurement Board	Material	Board Size
4 Layers	FR-4	114.3mm x 76.2mm x 1.6mmt

Top		2 Internal Layers		Bottom	
Copper Pattern	Thickness	Copper Pattern	Thickness	Copper Pattern	Thickness
Footprints and Traces	70μm	74.2mm x 74.2mm	35μm	74.2mm x 74.2mm	70μm

● Performance Curve (Reference Data)

■ BD50FA1MG-M

(Unless otherwise specified, $T_a=25^\circ\text{C}$, $V_{CC}=10\text{V}$, $V_{EN}=3\text{V}$, $C_{IN}=C_{OUT}=2.2\mu\text{F}$)

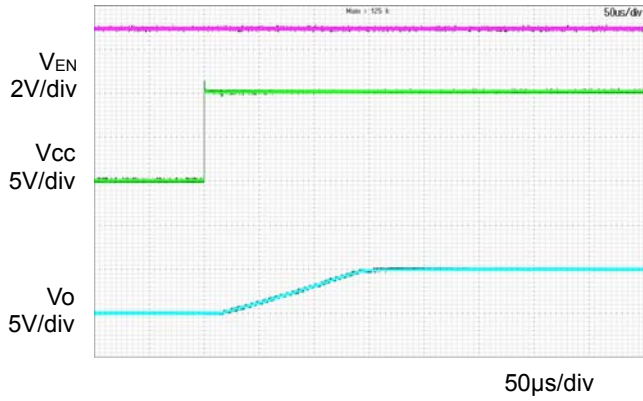

Figure 2. Input sequence ($T_a=25^\circ\text{C}$)
($V_{CC} = 0\text{V} \rightarrow 10\text{V}$)

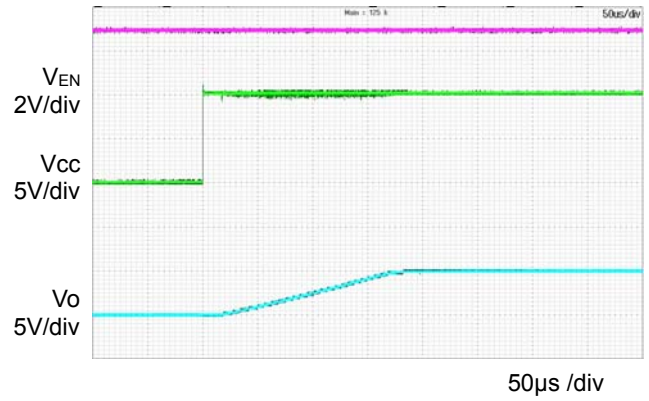

Figure 3. Input sequence ($T_a=-40^\circ\text{C}$)
($V_{CC} = 0\text{V} \rightarrow 10\text{V}$)

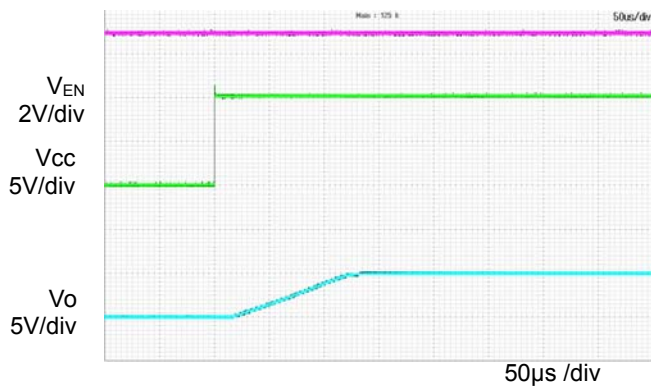

Figure 4. Input sequence ($T_a=105^\circ\text{C}$)
($V_{CC} = 0\text{V} \rightarrow 10\text{V}$)

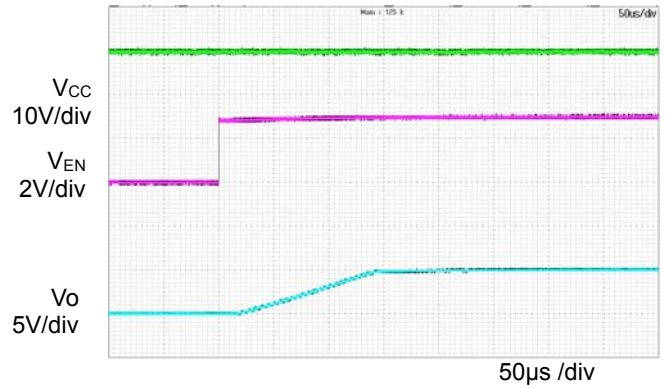

Figure 5. Input sequence ($T_a=25^\circ\text{C}$)
($V_{CC} = 10\text{V}$, $V_{EN} = 0\text{V} \rightarrow 3\text{V}$)

● Performance Curve (Reference Data)

■ BD50FA1MG-M

(Unless otherwise specified, $T_a=25^\circ\text{C}$, $V_{CC}=10\text{V}$, $V_{EN}=3\text{V}$, $C_{IN}=C_{OUT}=2.2\mu\text{F}$)

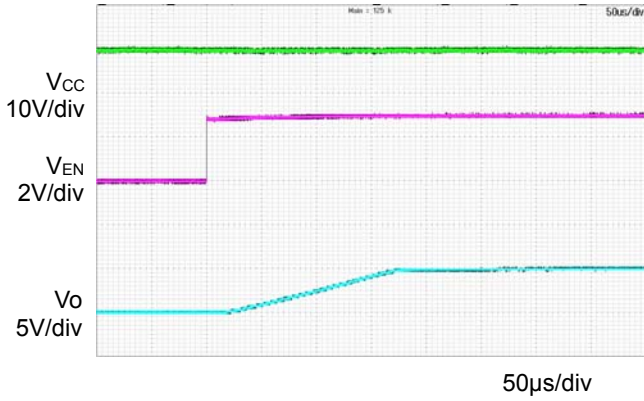

Figure 6. Input sequence ($T_a=-40^\circ\text{C}$)
($EN = 0\text{V}\rightarrow 3\text{V}$)

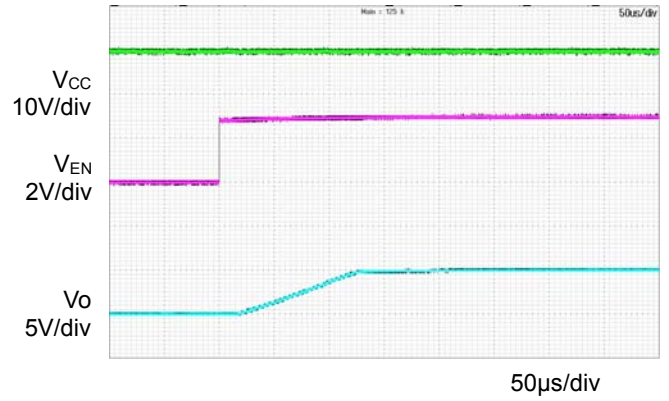

Figure 7. Input sequence ($T_a=105^\circ\text{C}$)
($EN = 0\text{V}\rightarrow 3\text{V}$)



Figure 8. Transient Response ($T_a=25^\circ\text{C}$)
($I_o = 0\text{A}\rightarrow 0.1\text{A}$)



Figure 9. Transient Response ($T_a=25^\circ\text{C}$)
($I_o = 0.1\text{A}\rightarrow 0\text{A}$)

● Performance Curve (Reference Data)

■ BD50FA1MG-M

(Unless otherwise specified, $T_a=25^\circ\text{C}$, $V_{CC}=10\text{V}$, $V_{EN}=3\text{V}$, $C_{IN}=C_{OUT}=2.2\mu\text{F}$)



Figure 10. Transient Response ($T_a=-40^\circ\text{C}$)
($I_o = 0\text{A} \rightarrow 0.1\text{A}$)



Figure 11. Transient Response ($T_a=-40^\circ\text{C}$)
($I_o = 0.1\text{A} \rightarrow 0\text{A}$)



Figure 12. Transient Response ($T_a=105^\circ\text{C}$)
($I_o = 0\text{A} \rightarrow 0.1\text{A}$)



Figure 13. Transient Response ($T_a=105^\circ\text{C}$)
($I_o = 0.1\text{A} \rightarrow 0\text{A}$)

● Performance Curve (Reference Data)

■ BD50FA1MG-M

(Unless otherwise specified, $T_a=25^\circ\text{C}$, $V_{CC}=10\text{V}$, $V_{EN}=3\text{V}$, $C_{IN}=C_{OUT}=2.2\mu\text{F}$)

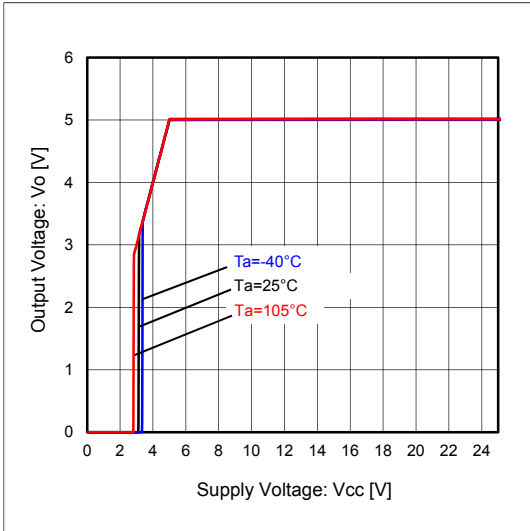

Figure 14. $V_{CC} - V_o$

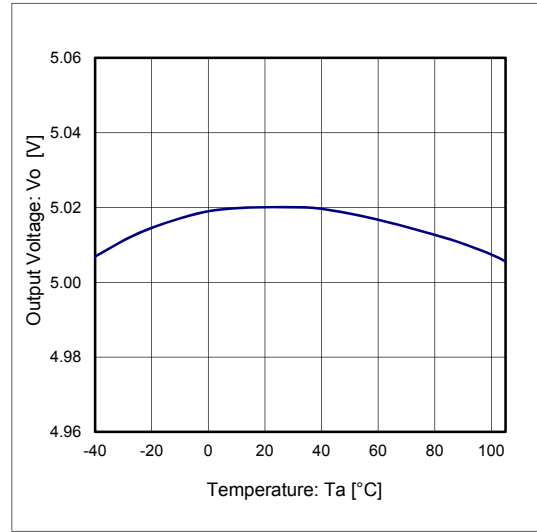

Figure 15. $T_a - V_o$
($I_o = 0\text{mA}$)

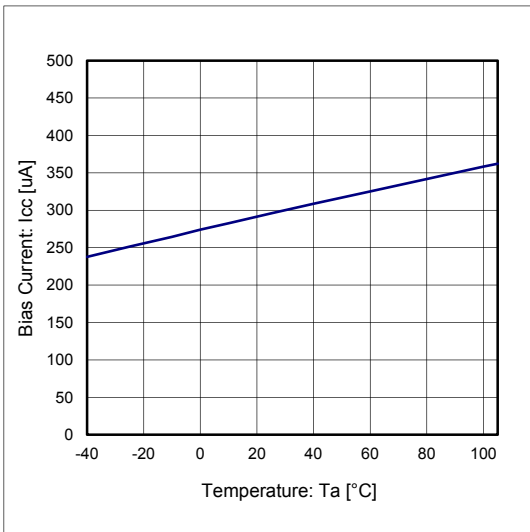

Figure 16. $T_a - I_{CC}$

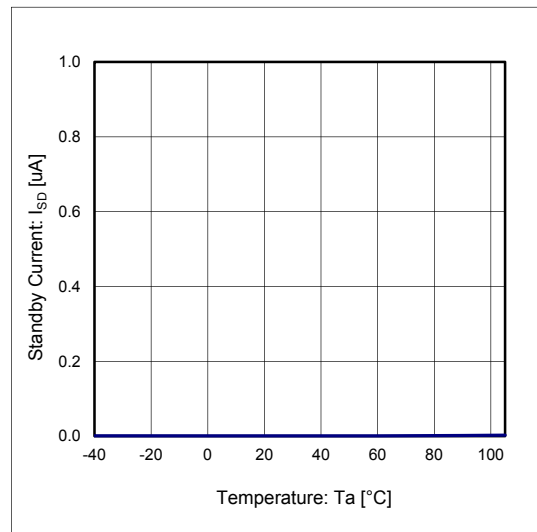

Figure 17. $T_a - I_{SD}$
($V_{EN}=0\text{V}$)

● Performance Curve (Reference Data)

■ BD50FA1MG-M

(Unless otherwise specified, $T_a=25^\circ\text{C}$, $V_{CC}=10\text{V}$, $V_{EN}=3\text{V}$, $C_{IN}=C_{OUT}=2.2\mu\text{F}$)

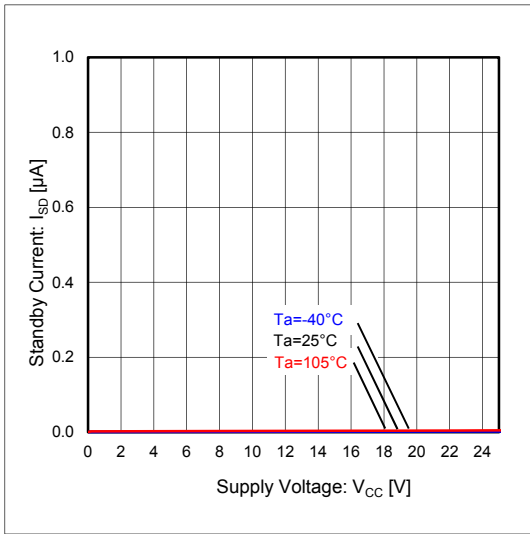

Figure 18. $V_{CC}-I_{SD}$
($V_{EN}=0\text{V}$)

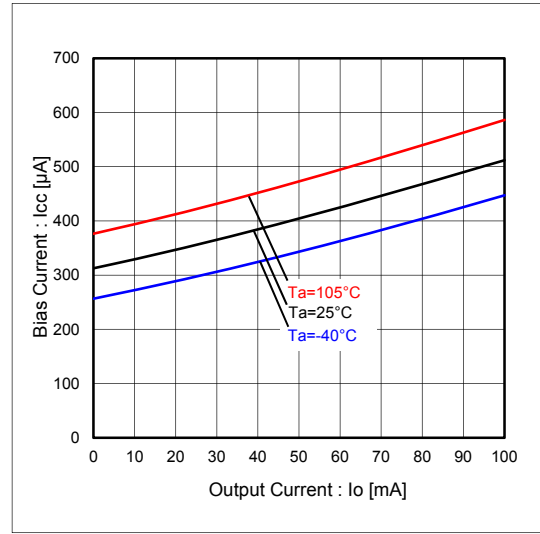

Figure 19. $I_o - I_{CC}$

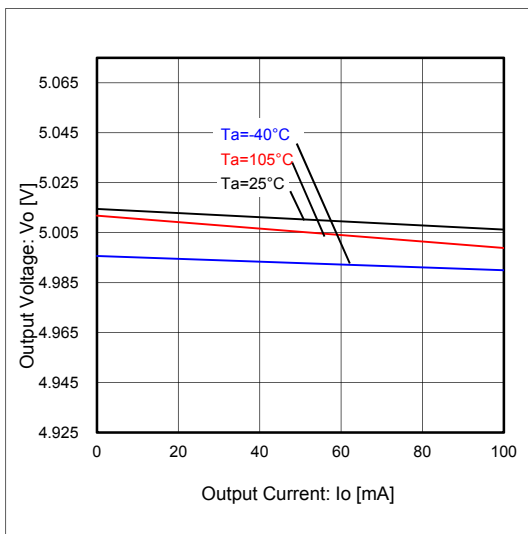

Figure 20. $I_o - V_o$

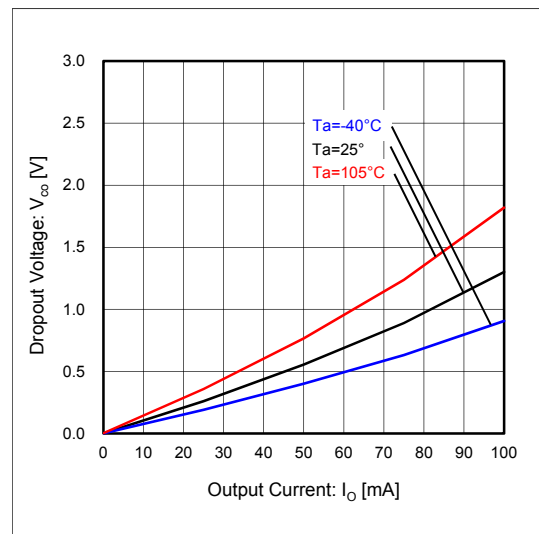

Figure 21. Minimum Dropout Voltage
($V_{CC}=4.75\text{V}$)

● Performance Curve (Reference Data)

■ BD50FA1MG-M

(Unless otherwise specified, $T_a=25^\circ\text{C}$, $V_{cc}=10\text{V}$, $V_{EN}=3\text{V}$, $C_{IN}=C_{OUT}=2.2\mu\text{F}$)

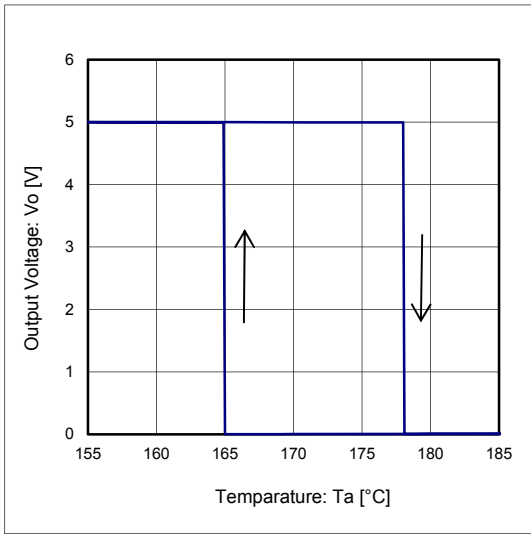

Figure 22. TSD
($I_o = 0\text{mA}$)

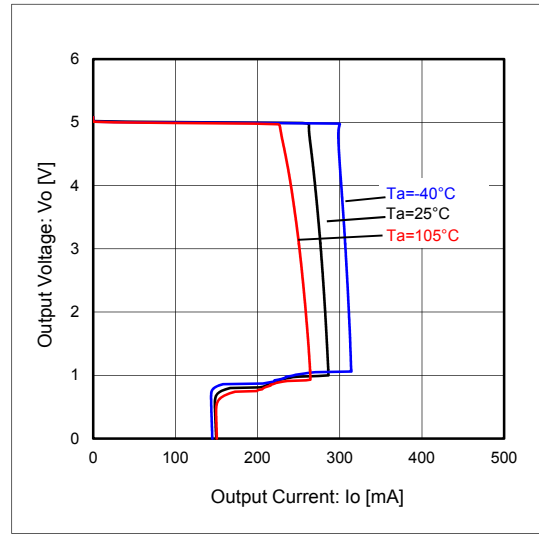

Figure 23. OCP

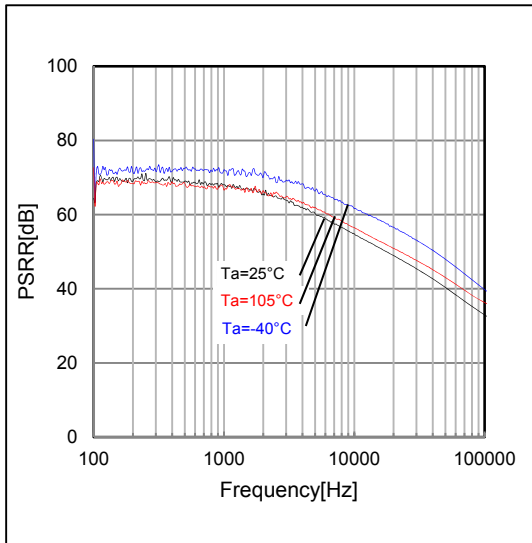

Figure 24. PSRR
(Input Voltage Ripple = 1Vrms, $I_o = 50\text{mA}$)

● Linear Regulators Surge Voltage Protection

The following provides instructions on surge voltage overs absolute maximum ratings polarity protection for ICs.

1. Applying positive surge to the input

If the possibility exists that surges higher than absolute maximum ratings 30 V will be applied to the input, a Zener Diode should be placed to protect the device in between the V_{IN} and the GND as shown in the figure 25.

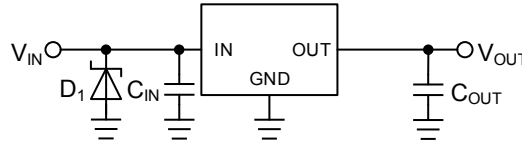

Figure 25. Surges Higher than 30 V will be Applied to the Input

2. Applying negative surge to the input

If the possibility exists that surges lower than absolute maximum ratings -0.3 V will be applied to the input, a Schottky Diode should be placed to protect the device in between the V_{IN} and the GND as shown in the figure 26.

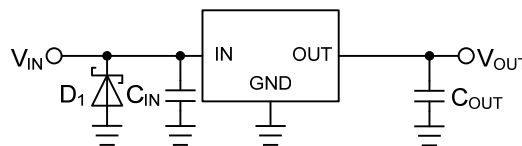

Figure 26. Surges Lower than -0.3 V will be Applied to the Input

● Linear Regulators Reverse Voltage Protection

A linear regulator integrated circuit (IC) requires that the input voltage is always higher than the regulated voltage. Output voltage, however, may become higher than the input voltage under specific situations or circuit configurations, and that reverse voltage and current may cause damage to the IC. A reverse polarity connection or certain inductor components can also cause a polarity reversal between the input and output pins. The following provides instructions on reversed voltage polarity protection for ICs.

1. about Input /Output Voltage Reversal

In an MOS linear regulator, a parasitic element exists as a body diode in the drain-source junction portion of its power MOSFET. Reverse input/output voltage triggers the current flow from the output to the input through the body diode. The inverted current may damage or destroy the semiconductor elements of the regulator since the effect of the parasitic body diode is usually disregarded for the regulator behavior (Figure 27).

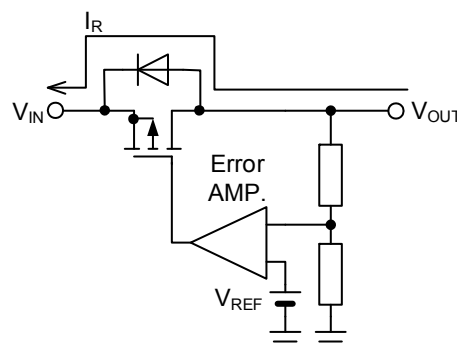

Figure 27. Reverse Current Path in an MOS Linear Regulator

An effective solution to this is an external bypass diode connected in-between the input and output to prevent the reverse current flow inside the IC (see Figure 28). Note that the bypass diode must be turned on before the internal circuit of the IC. Bypass diodes in the internal circuits of MOS linear regulators must have low forward voltage V_F . Some ICs are configured with current-limit thresholds to shut down high reverse current even when the output is off, allowing large leakage current from the diode to flow from the input to the output; therefore, it is necessary to choose one that has a small reverse current. Specifically, select a diode with a rated peak inverse voltage greater than the input to output voltage differential and rated forward current greater than the reverse current during use.

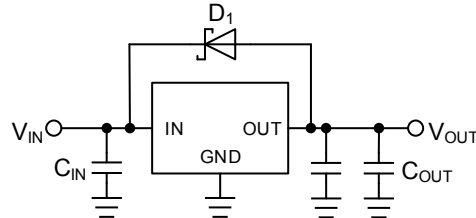

Figure 28. Bypass Diode for Reverse Current

The lower forward voltage (V_F) of Schottky barrier diodes cater to requirements of MOS linear regulators, however the main drawback is found in the level of their reverse current (I_R), which is relatively high. So, one with a low reverse current is recommended when choosing a Schottky diode. The V_R - I_R characteristics versus temperatures show increases at higher temperatures.

If V_{IN} is open in a circuit as shown in the following Figure 29 with its input/output voltage being reversed, the only current that flows in the reverse current path is the bias current of the IC. Because the amperage is too low to damage or destroy the parasitic element, a reverse current bypass diode is not required for this type of circuit.

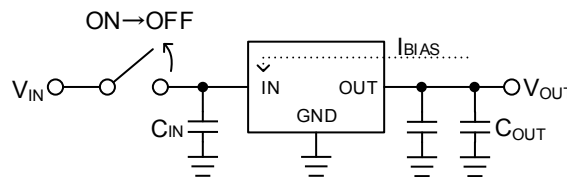

Figure 29. Open V_{IN}

2. Protection against Input Reverse Voltage

Accidental reverse polarity at the input connection flows a large current to the diode for electrostatic breakdown protection between the input pin of the IC and the GND pin, which may destroy the IC (see Figure 30).

A Schottky barrier diode or rectifier diode connected in series with the power supply as shown in Figure 31 is the simplest solution to prevent this from happening. The solution, however, is unsuitable for a circuit powered by batteries because there is a power loss calculated as $V_F \times I_{OUT}$, as the forward voltage V_F of the diode drops in a correct connection. The lower V_F of a Schottky barrier diode than that of a rectifier diode gives a slightly smaller power loss. Because diodes generate heat, care must be taken to select a diode that has enough allowance in power dissipation. A reverse connection allows a negligible reverse current to flow in the diode.

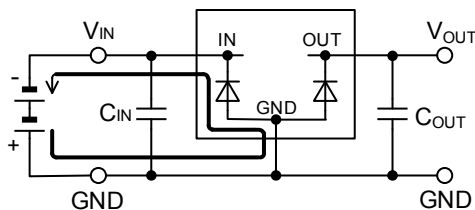

Figure 30. Current Path in Reverse Input Connection

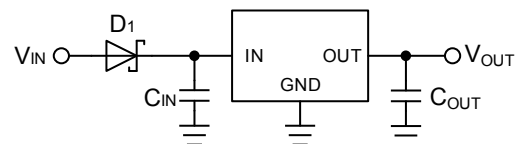

Figure 31. Protection against Reverse Polarity 1

Figure 32 shows a circuit in which a P-channel MOSFET is connected in series with the power. The diode located in the drain-source junction portion of the MOSFET is a body diode (parasitic element). The voltage drop in a correct connection is calculated by multiplying the resistance of the MOSFET being turned on by the output current I_{OUT} , therefore it is smaller than the voltage drop by the diode (see Figure 31) and results in less of a power loss. No current flows in a reverse connection where the MOSFET remains off.

If the voltage taking account of derating is greater than the voltage rating of MOSFET gate-source junction, lower the gate-source junction voltage by connecting voltage dividing resistors as shown in Figure 33.

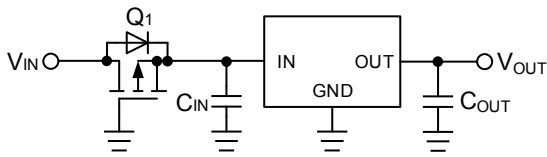

Figure 32. Protection against Reverse Polarity 2

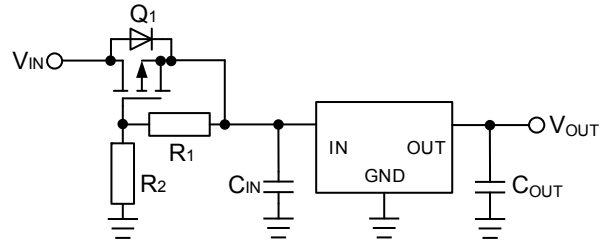

Figure 33. Protection against Reverse Polarity 3

3. Protection against Output Reverse Voltage when Output Connect to an Inductor

If the output load is inductive, electrical energy accumulated in the inductive load is released to the ground upon the output voltage turning off. In-between the IC output and ground pins is a diode for preventing electrostatic breakdown, in which a large current flows that could destroy the IC. To prevent this from happening, connect a Schottky barrier diode in parallel with the diode (see Figure 34).

Further, if a long wire is in use for the connection between the output pin of the IC and the load, observe the waveform on an oscilloscope, since it is possible that the load becomes inductive. An additional diode is needed for a motor load that is affected by its counter electromotive force, as it produces an electrical current in a similar way.

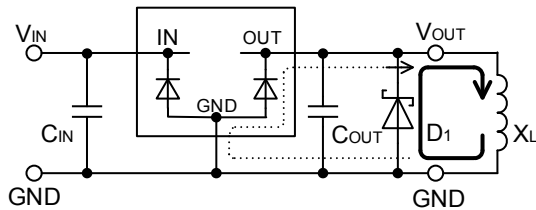

Figure 34. Current Path in Inductive Load (Output: Off)

● Power Dissipation

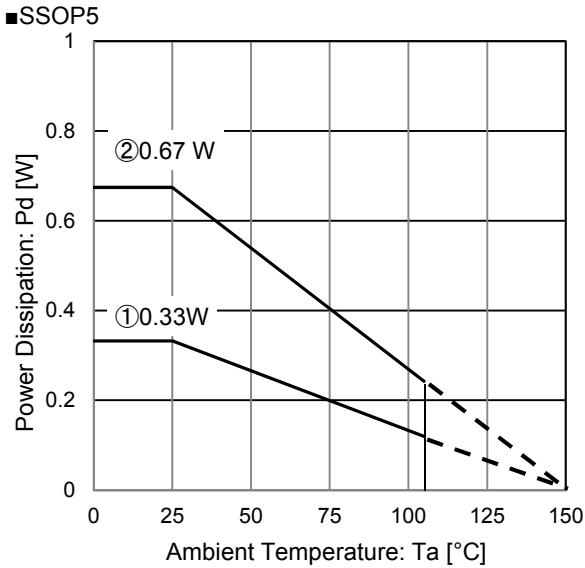

Figure 35. SSOP5 Power Dissipation Data(reference)

IC mounted on ROHM standard board based on JEDEC.

Board material: FR4

Board size:

1s	114.3 mm x 76.2 mm x 1.57 mmt
2s2p	114.3 mm x 76.2 mm x 1.6 mmt

Mount condition: PCB and exposed pad are soldered.

Top copper foil: The footprint ROHM recommend.

+ wiring to measure.

①: 1-layer PCB (Copper foil area on the reverse side of PCB: 0 mm x 0 mm)

②: 4-layer PCB (2 inner layers and copper foil area on the reverse side of PCB: 74.2mm x 74.2 mm)

Condition①: $\theta_{JA} = 376.5 \text{ }^\circ\text{C/W}$, $\Psi_{JT}=40 \text{ }^\circ\text{C/W}$

Condition②: $\theta_{JA} = 185.4 \text{ }^\circ\text{C/W}$, $\Psi_{JT}=30 \text{ }^\circ\text{C/W}$

● Thermal Design

Within this IC, the power consumption is decided by the dropout voltage condition, the load current and the circuit current.

Refer to power dissipation curves illustrated in Figure 35 when using the IC in an environment of $T_a \geq 25 \text{ }^\circ\text{C}$. Even if the ambient temperature T_a is at $25 \text{ }^\circ\text{C}$, depending on the input voltage and the load current, chip junction temperature can be very high. Consider the design to be $T_j \leq T_{jmax} = 150 \text{ }^\circ\text{C}$ in all possible operating temperature range.

Should by any condition the maximum junction temperature $T_{jmax} = 150 \text{ }^\circ\text{C}$ rating be exceeded by the temperature increase of the chip, it may result in deterioration of the properties of the chip. The thermal impedance in this specification is based on recommended PCB and measurement condition by JEDEC standard. Verify the application and allow sufficient margins in the thermal design by the following method is used to calculate the junction temperature T_j .

T_j can be calculated by either of the two following methods.

1. The following method is used to calculate the junction temperature T_j .

$$T_j = T_a + P_c \times \theta_{JA}$$

Where:

- T_j : Junction Temperature
- T_a : Ambient Temperature
- P_c : Power Consumption
- θ_{JA} : Thermal Impedance (Junction to Ambient)

2. The following method is also used to calculate the junction temperature T_j .

$$T_j = T_T + P_c \times \Psi_{JT}$$

Where:

- T_j : Junction Temperature
- T_T : Top Center of Case's (mold) Temperature
- P_c : Power consumption
- Ψ_{JT} : Thermal Impedance (Junction to Top Center of Case)

The following method is used to calculate the power consumption P_c (W).

$$P_c = (V_{cc} - V_o) \times I_o + V_{cc} \times I_{cc}$$

Where:

P_c	: Power Consumption
V_{cc}	: Input Voltage
V_o	: Output Voltage
I_o	: Load Current
I_{cc}	: Circuit Current

• Calculation Example (SSOP5)

If $V_{cc} = 8.0$ V, $V_o = 5.0$ V, $I_o = 50$ mA, $I_{GND} = 400$ μ A, the power consumption P_c can be calculated as follows:

$$\begin{aligned} P_c &= (V_{cc} - V_o) \times I_o + V_{cc} \times I_{cc} \\ &= (8.0 \text{ V} - 5.0 \text{ V}) \times 50 \text{ mA} + 8.0 \text{ V} \times 400 \text{ } \mu\text{A} \\ &= 0.153 \text{ W} \end{aligned}$$

At the ambient temperature $T_{max} = 105^\circ\text{C}$, the thermal Impedance (Junction to Ambient) $\theta_{JA} = 185.4$ $^\circ\text{C} / \text{W}$ (4-layer PCB),

$$\begin{aligned} T_j &= T_{max} + P_c \times \theta_{JA} \\ &= 105 \text{ }^\circ\text{C} + 0.153 \text{ W} \times 185.4 \text{ }^\circ\text{C} / \text{W} \\ &= 133.4 \text{ }^\circ\text{C} \end{aligned}$$

When operating the IC, the top center of case's (mold) temperature $T_T = 100$ $^\circ\text{C}$ 、 $\Psi_{JT} = 40$ $^\circ\text{C} / \text{W}$ (1-layer PCB),

$$\begin{aligned} T_j &= T_T + P_c \times \Psi_{JT} \\ &= 100 \text{ }^\circ\text{C} + 0.153 \text{ W} \times 40 \text{ }^\circ\text{C} / \text{W} \\ &= 106.1 \text{ }^\circ\text{C} \end{aligned}$$

For optimum thermal performance, it is recommended to expand the copper foil area of the board, increasing the layer and thermal via between thermal land pad.

● Input/Output Capacitor

It is recommended that a capacitor is placed close to pin between input pin and GND as well as output pin and GND. The input capacitor becomes more necessary when the power supply impedance is high or when the PCB trace has significant length. Moreover, the higher the capacitance of the output capacitor the more stable the output will be, even with load and line voltage variations. However, please check the actual functionality by mounting on a board for the actual application.

Also, ceramic capacitors usually have different thermal and equivalent series resistance characteristics and may degrade gradually over continued use.

For additional details, please check with the manufacturer and select the best ceramic capacitor for your application.

● Output Capacitor Equivalent Series Resistance

To prevent oscillation, please attach a capacitor between V_O and GND. Generally, capacitor has ESR (Equivalent Series Resistance). Operation will be stable in ESR- I_o range shown in the right.

The 2.2 μ F ceramic capacitor and resistor at output in this characteristic data are connected in series and measured under condition of $T_a = -40^\circ\text{C}$ to 105°C and $V_{cc} \leq 25\text{V}$. Generally, ESR of ceramic capacitor, tantalum capacitor and electrolytic capacitor is different. Check the ESR of capacitor to be used and use it within the range of stable region.

However, please take note that for the same value of capacitance of different electrolytic capacitor, ESR are not always the same. In addition, ESR characteristics may also change due to wiring impedance of board, input power impedance and load impedance; therefore check the behavior in actual application.

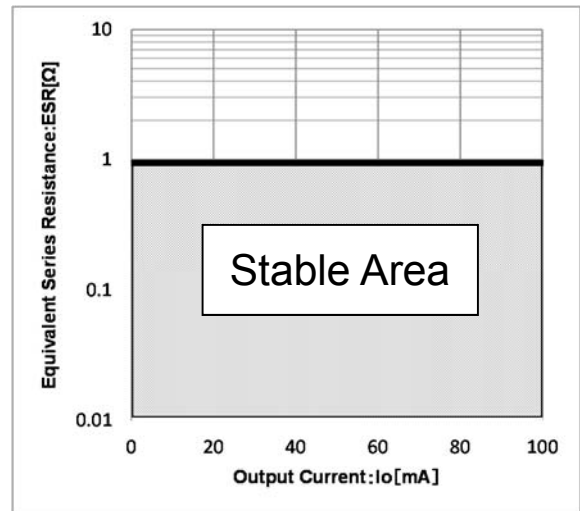

●Operational Notes**1. Reverse Connection of Power Supply**

Connecting the power supply in reverse polarity can damage the IC. Take precautions against reverse polarity when connecting the power supply, such as mounting an external diode between the power supply and the IC's power supply pins.

2. Power Supply Lines

Design the PCB layout pattern to provide low impedance supply lines. Furthermore, connect a capacitor to ground at all power supply pins. Consider the effect of temperature and aging on the capacitance value when using electrolytic capacitors.

3. Ground Voltage

Ensure that no pins are at a voltage below that of the ground pin at any time, even during transient condition.

4. Ground Wiring Pattern

When using both small-signal and large-current ground traces, the two ground traces should be routed separately but connected to a single ground at the reference point of the application board to avoid fluctuations in the small-signal ground caused by large currents. Also ensure that the ground traces of external components do not cause variations on the ground voltage. The ground lines must be as short and thick as possible to reduce line impedance.

5. Thermal Consideration

Should by any chance the maximum junction temperature rating be exceeded the rise in temperature of the chip may result in deterioration of the properties of the chip. In case of exceeding this absolute maximum rating, increase the board size and copper area to prevent exceeding the maximum junction temperature rating.

6. Recommended Operating Conditions

The electrical characteristics are guaranteed under the conditions of each parameter.

7. Inrush Current

When power is first supplied to the IC, it is possible that the internal logic may be unstable and inrush current may flow instantaneously due to the internal powering sequence and delays, especially if the IC has more than one power supply. Therefore, give special consideration to power coupling capacitance, power wiring, width of ground wiring, and routing of connections.

8. Testing on Application Boards

When testing the IC on an application board, connecting a capacitor directly to a low-impedance output pin may subject the IC to stress. Always discharge capacitors completely after each process or step. The IC's power supply should always be turned off completely before connecting or removing it from the test setup during the inspection process. To prevent damage from static discharge, ground the IC during assembly and use similar precautions during transport and storage.

9. Inter-pin Short and Mounting Errors

Ensure that the direction and position are correct when mounting the IC on the PCB. Incorrect mounting may result in damaging the IC. Avoid nearby pins being shorted to each other especially to ground, power supply and output pin. Inter-pin shorts could be due to many reasons such as metal particles, water droplets (in very humid environment) and unintentional solder bridge deposited in between pins during assembly to name a few.

10. Unused Input Pins

Input pins of an IC are often connected to the gate of a MOS transistor. The gate has extremely high impedance and extremely low capacitance. If left unconnected, the electric field from the outside can easily charge it. The small charge acquired in this way is enough to produce a significant effect on the conduction through the transistor and cause unexpected operation of the IC. So unless otherwise specified, unused input pins should be connected to the power supply or ground line.

Operational Notes – continued

11. Regarding the Input Pin of the IC

This monolithic IC contains P+ isolation and P substrate layers between adjacent elements in order to keep them isolated. P-N junctions are formed at the intersection of the P layers with the N layers of other elements, creating a parasitic diode or transistor. For example (refer to figure below):

When $GND > Pin A$ and $GND > Pin B$, the P-N junction operates as a parasitic diode.

When $GND > Pin B$, the P-N junction operates as a parasitic transistor.

Parasitic diodes inevitably occur in the structure of the IC. The operation of parasitic diodes can result in mutual interference among circuits, operational faults, or physical damage. Therefore, conditions that cause these diodes to operate, such as applying a voltage lower than the GND voltage to an input pin (and thus to the P substrate) should be avoided. When each terminal voltage is reversed to a power supply terminal in application, an internal circuit or an element may be damaged. For example, in the state that an electric charge was charged by an external condenser, a power supply terminal is a case short-circuited by GND. In addition, it was recommended that you insert the diode of the bypass in power supply terminal series between a diode of the prevention of countercurrent or each terminal and power supply terminal.

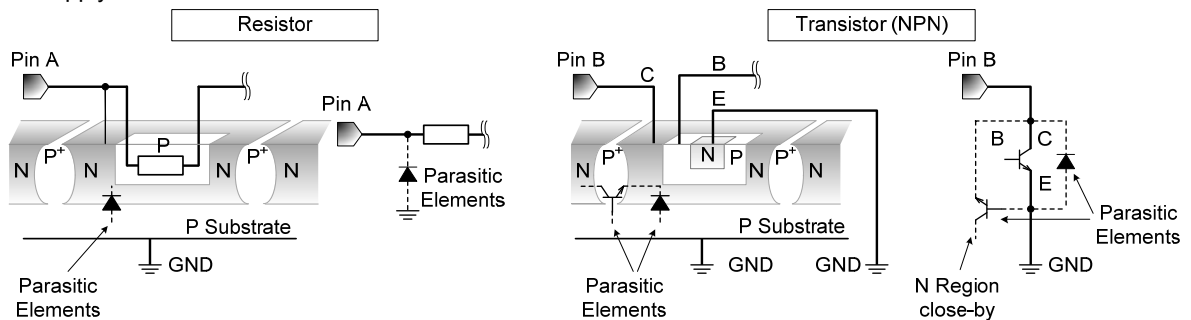
**12. Ceramic Capacitor**

When using a ceramic capacitor, determine the dielectric constant considering the change of capacitance with temperature and the decrease in nominal capacitance due to DC bias and others.

13. Area of Safe Operation

Operate the IC such that the output voltage, output current, and power dissipation are all within the maximum ratings.

14. Thermal Shutdown Circuit(TSD)

This IC has a built-in thermal shutdown circuit that prevents heat damage to the IC. Normal operation should always be within the IC's power dissipation rating. If however the rating is exceeded for a continued period, the junction temperature (T_j) will rise which will activate the TSD circuit that will turn OFF all output pins. When the T_j falls below the TSD threshold, the circuits are automatically restored to normal operation.

Note that the TSD circuit operates in a situation that exceeds the absolute maximum ratings and therefore, under no circumstances, should the TSD circuit be used in a set design or for any purpose other than protecting the IC from heat damage.

15. Over Current Protection Circuit (OCP)

This IC incorporates an integrated overcurrent protection circuit that is activated when the load is shorted. This protection circuit is effective in preventing damage due to sudden and unexpected incidents. However, the IC should not be used in applications characterized by continuous operation or transitioning of the protection circuit.

● Marking Diagram

xx	Output Voltage	Marking
50	5.0V	XZ

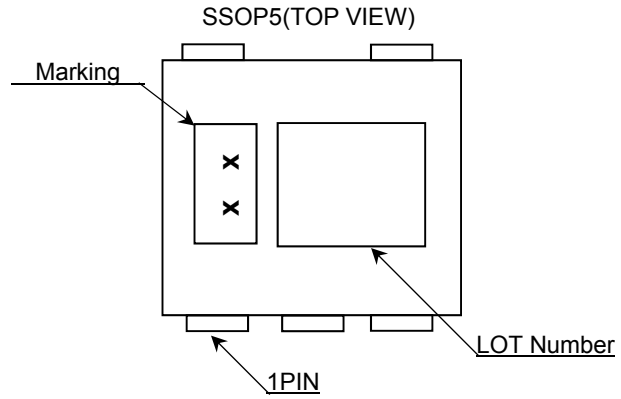

● Physical Dimension Tape and Reel Information

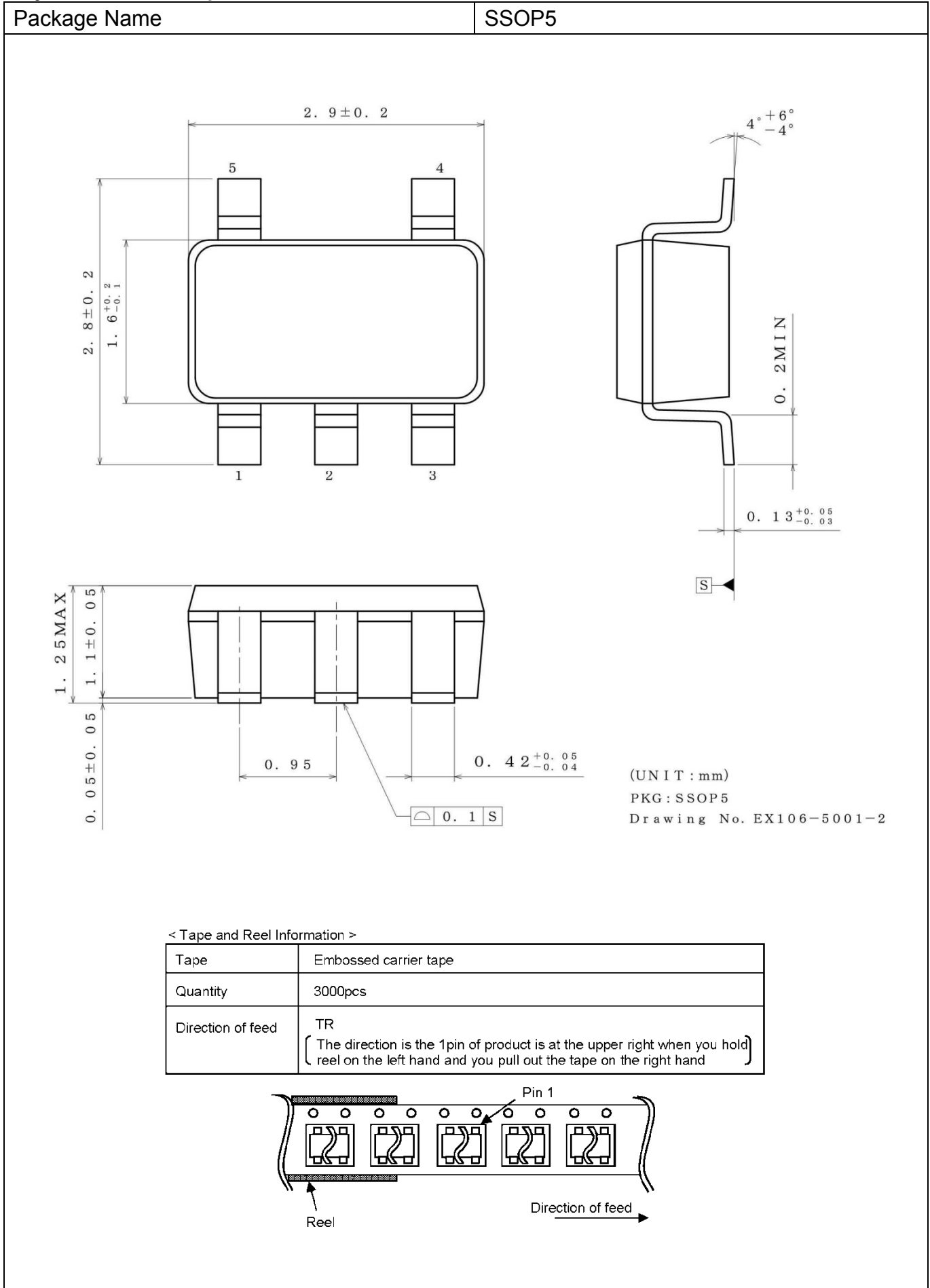

●Revision History

Date	Revision	Revision contents
11.Nov.2015	001	New release
3.Feb.2016	002	P3 output voltage limit modified All input voltage symbol changed into Vcc All Output voltage symbol changed into Vo
15.Feb.2017	003	P2 Block explanation added P3 Combined duplicate limits between 25°C and -40°C to +105°C in Electric Characteristics P4 Copper Pattern modified(74.2mm ² →74.2mm x 74.2mm) P5 to 7 Figure 2 to 13 changed from C _{IN} ,C _{OUT} =1μF to C _{IN} ,C _{OUT} =2.2μF which are Typ value in Recommended Operating Conditions P9 Figure 21. Minimum Dropout Voltage data changed to more appropriate condition (Vcc=4.75V) P10 Figure 24. PSRR condition data changed to more appropriate condition(Io=50mA) P11 to 13 Linear Regulators Surge Voltage Protection added Linear Regulators Reverse Voltage Protection added Evaluation Board Circuit, Evaluation Parts List and Board Layout deleted due to duplication with other section The document control number:TSZ02201-0GEG0A600050-1-2→TSZ02201-0G1G0A6005901-2

Notice

Precaution on using ROHM Products

1. If you intend to use our Products in devices requiring extremely high reliability (such as medical equipment ^(Note 1), aircraft/spacecraft, nuclear power controllers, etc.) and whose malfunction or failure may cause loss of human life, bodily injury or serious damage to property ("Specific Applications"), please consult with the ROHM sales representative in advance. Unless otherwise agreed in writing by ROHM in advance, ROHM shall not be in any way responsible or liable for any damages, expenses or losses incurred by you or third parties arising from the use of any ROHM's Products for Specific Applications.

(Note1) Medical Equipment Classification of the Specific Applications

JAPAN	USA	EU	CHINA
CLASS III	CLASS III	CLASS II b	CLASS III
CLASS IV		CLASS III	

2. ROHM designs and manufactures its Products subject to strict quality control system. However, semiconductor products can fail or malfunction at a certain rate. Please be sure to implement, at your own responsibilities, adequate safety measures including but not limited to fail-safe design against the physical injury, damage to any property, which a failure or malfunction of our Products may cause. The following are examples of safety measures:
 - [a] Installation of protection circuits or other protective devices to improve system safety
 - [b] Installation of redundant circuits to reduce the impact of single or multiple circuit failure
3. Our Products are not designed under any special or extraordinary environments or conditions, as exemplified below. Accordingly, ROHM shall not be in any way responsible or liable for any damages, expenses or losses arising from the use of any ROHM's Products under any special or extraordinary environments or conditions. If you intend to use our Products under any special or extraordinary environments or conditions (as exemplified below), your independent verification and confirmation of product performance, reliability, etc. prior to use, must be necessary:
 - [a] Use of our Products in any types of liquid, including water, oils, chemicals, and organic solvents
 - [b] Use of our Products outdoors or in places where the Products are exposed to direct sunlight or dust
 - [c] Use of our Products in places where the Products are exposed to sea wind or corrosive gases, including Cl₂, H₂S, NH₃, SO₂, and NO₂
 - [d] Use of our Products in places where the Products are exposed to static electricity or electromagnetic waves
 - [e] Use of our Products in proximity to heat-producing components, plastic cords, or other flammable items
 - [f] Sealing or coating our Products with resin or other coating materials
 - [g] Use of our Products without cleaning residue of flux (even if you use no-clean type fluxes, cleaning residue of flux is recommended); or Washing our Products by using water or water-soluble cleaning agents for cleaning residue after soldering
 - [h] Use of the Products in places subject to dew condensation
4. The Products are not subject to radiation-proof design.
5. Please verify and confirm characteristics of the final or mounted products in using the Products.
6. In particular, if a transient load (a large amount of load applied in a short period of time, such as pulse. is applied, confirmation of performance characteristics after on-board mounting is strongly recommended. Avoid applying power exceeding normal rated power; exceeding the power rating under steady-state loading condition may negatively affect product performance and reliability.
7. De-rate Power Dissipation depending on ambient temperature. When used in sealed area, confirm that it is the use in the range that does not exceed the maximum junction temperature.
8. Confirm that operation temperature is within the specified range described in the product specification.
9. ROHM shall not be in any way responsible or liable for failure induced under deviant condition from what is defined in this document.

Precaution for Mounting / Circuit board design

1. When a highly active halogenous (chlorine, bromine, etc.) flux is used, the residue of flux may negatively affect product performance and reliability.
2. In principle, the reflow soldering method must be used on a surface-mount products, the flow soldering method must be used on a through hole mount products. If the flow soldering method is preferred on a surface-mount products, please consult with the ROHM representative in advance.

For details, please refer to ROHM Mounting specification

Precautions Regarding Application Examples and External Circuits

1. If change is made to the constant of an external circuit, please allow a sufficient margin considering variations of the characteristics of the Products and external components, including transient characteristics, as well as static characteristics.
2. You agree that application notes, reference designs, and associated data and information contained in this document are presented only as guidance for Products use. Therefore, in case you use such information, you are solely responsible for it and you must exercise your own independent verification and judgment in the use of such information contained in this document. ROHM shall not be in any way responsible or liable for any damages, expenses or losses incurred by you or third parties arising from the use of such information.

Precaution for Electrostatic

This Product is electrostatic sensitive product, which may be damaged due to electrostatic discharge. Please take proper caution in your manufacturing process and storage so that voltage exceeding the Products maximum rating will not be applied to Products. Please take special care under dry condition (e.g. Grounding of human body / equipment / solder iron, isolation from charged objects, setting of Ionizer, friction prevention and temperature / humidity control).

Precaution for Storage / Transportation

1. Product performance and soldered connections may deteriorate if the Products are stored in the places where:
 - [a] the Products are exposed to sea winds or corrosive gases, including Cl₂, H₂S, NH₃, SO₂, and NO₂
 - [b] the temperature or humidity exceeds those recommended by ROHM
 - [c] the Products are exposed to direct sunshine or condensation
 - [d] the Products are exposed to high Electrostatic
2. Even under ROHM recommended storage condition, solderability of products out of recommended storage time period may be degraded. It is strongly recommended to confirm solderability before using Products of which storage time is exceeding the recommended storage time period.
3. Store / transport cartons in the correct direction, which is indicated on a carton with a symbol. Otherwise bent leads may occur due to excessive stress applied when dropping of a carton.
4. Use Products within the specified time after opening a humidity barrier bag. Baking is required before using Products of which storage time is exceeding the recommended storage time period.

Precaution for Product Label

A two-dimensional barcode printed on ROHM Products label is for ROHM's internal use only.

Precaution for Disposition

When disposing Products please dispose them properly using an authorized industry waste company.

Precaution for Foreign Exchange and Foreign Trade act

Since concerned goods might be fallen under listed items of export control prescribed by Foreign exchange and Foreign trade act, please consult with ROHM in case of export.

Precaution Regarding Intellectual Property Rights

1. All information and data including but not limited to application example contained in this document is for reference only. ROHM does not warrant that foregoing information or data will not infringe any intellectual property rights or any other rights of any third party regarding such information or data.
2. ROHM shall not have any obligations where the claims, actions or demands arising from the combination of the Products with other articles such as components, circuits, systems or external equipment (including software).
3. No license, expressly or implied, is granted hereby under any intellectual property rights or other rights of ROHM or any third parties with respect to the Products or the information contained in this document. Provided, however, that ROHM will not assert its intellectual property rights or other rights against you or your customers to the extent necessary to manufacture or sell products containing the Products, subject to the terms and conditions herein.

Other Precaution

1. This document may not be reprinted or reproduced, in whole or in part, without prior written consent of ROHM.
2. The Products may not be disassembled, converted, modified, reproduced or otherwise changed without prior written consent of ROHM.
3. In no event shall you use in any way whatsoever the Products and the related technical information contained in the Products or this document for any military purposes, including but not limited to, the development of mass-destruction weapons.
4. The proper names of companies or products described in this document are trademarks or registered trademarks of ROHM, its affiliated companies or third parties.

General Precaution

1. Before you use our Products, you are requested to carefully read this document and fully understand its contents. ROHM shall not be in any way responsible or liable for failure, malfunction or accident arising from the use of any ROHM's Products against warning, caution or note contained in this document.
2. All information contained in this document is current as of the issuing date and subject to change without any prior notice. Before purchasing or using ROHM's Products, please confirm the latest information with a ROHM sales representative.
3. The information contained in this document is provided on an "as is" basis and ROHM does not warrant that all information contained in this document is accurate and/or error-free. ROHM shall not be in any way responsible or liable for any damages, expenses or losses incurred by you or third parties resulting from inaccuracy or errors of or concerning such information.

Mouser Electronics

Authorized Distributor

Click to View Pricing, Inventory, Delivery & Lifecycle Information:

[ROHM Semiconductor:](#)

[BD50FA1MG-MTR](#)

Компания «Океан Электроники» предлагает заключение долгосрочных отношений при поставках импортных электронных компонентов на взаимовыгодных условиях!

Наши преимущества:

- Поставка оригинальных импортных электронных компонентов напрямую с производств Америки, Европы и Азии, а так же с крупнейших складов мира;
- Широкая линейка поставок активных и пассивных импортных электронных компонентов (более 30 млн. наименований);
- Поставка сложных, дефицитных, либо снятых с производства позиций;
- Оперативные сроки поставки под заказ (от 5 рабочих дней);
- Экспресс доставка в любую точку России;
- Помощь Конструкторского Отдела и консультации квалифицированных инженеров;
- Техническая поддержка проекта, помощь в подборе аналогов, поставка прототипов;
- Поставка электронных компонентов под контролем ВП;
- Система менеджмента качества сертифицирована по Международному стандарту ISO 9001;
- При необходимости вся продукция военного и аэрокосмического назначения проходит испытания и сертификацию в лаборатории (по согласованию с заказчиком);
- Поставка специализированных компонентов военного и аэрокосмического уровня качества (Xilinx, Altera, Analog Devices, Intersil, Interpoint, Microsemi, Actel, Aeroflex, Peregrine, VPT, Syfer, Eurofarad, Texas Instruments, MS Kennedy, Miteq, Cobham, E2V, MA-COM, Hittite, Mini-Circuits, General Dynamics и др.);

Компания «Океан Электроники» является официальным дистрибьютором и эксклюзивным представителем в России одного из крупнейших производителей разъемов военного и аэрокосмического назначения «JONHON», а так же официальным дистрибьютором и эксклюзивным представителем в России производителя высокотехнологичных и надежных решений для передачи СВЧ сигналов «FORSTAR».



JONHON

«JONHON» (основан в 1970 г.)

Разъемы специального, военного и аэрокосмического назначения:

(Применяются в военной, авиационной, аэрокосмической, морской, железнодорожной, горно- и нефтедобывающей отраслях промышленности)

«FORSTAR» (основан в 1998 г.)

ВЧ соединители, коаксиальные кабели, кабельные сборки и микроволновые компоненты:

(Применяются в телекоммуникациях гражданского и специального назначения, в средствах связи, РЛС, а так же военной, авиационной и аэрокосмической отраслях промышленности).



Телефон: 8 (812) 309-75-97 (многоканальный)

Факс: 8 (812) 320-03-32

Электронная почта: ocean@oceanchips.ru

Web: <http://oceanchips.ru/>

Адрес: 198099, г. Санкт-Петербург, ул. Калинина, д. 2, корп. 4, лит. А