

LMV301

Low Bias Current, 1.8V to 5V Single-Supply, Rail-to-Rail Operational Amplifier

The LMV301 CMOS operational amplifier can operate over a power supply range from 1.8 V to 5 V and has a quiescent current of less than 200 μA , maximum, making it ideal for portable battery-operated applications such as notebook computers, PDA's and medical equipment. Low input bias current and high input impedance make it highly tolerant of high source-impedance signal-sources such as photodiodes and pH probes. In addition, the LMV301's excellent rail-to-rail performance will enhance the signal-to-noise performance of any application together with an output stage capable of easily driving a 600 Ω resistive load and up to 1000 pF capacitive load.

Features

- Single Supply Operation (or $\pm V_S/2$)
- V_S from 1.8 V to 5 V
- Low Quiescent Current: 185 μA , Max with $V_S = 1.8 \text{ V}$
- Rail-to-Rail Output Swing
- Low Bias Current: 35 pA, max
- No Output Phase-Reversal when the Inputs are Overdriven
- These are Pb-Free Devices

Typical Applications

- Portable Battery-Powered Instruments
- Notebook Computers and PDAs
- Cell Phones and Mobile Communication
- Digital Cameras
- Photodiode Amplifiers
- Transducer Amplifiers
- Medical Instrumentation
- Consumer Products



ON Semiconductor®

<http://onsemi.com>

MARKING DIAGRAMS



SC70-5
SQ SUFFIX
CASE 419A
STYLES 2, 3

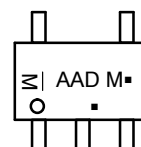

TSOP-5
CASE 483

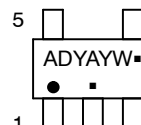

M = Date Code
A = Assembly Location
Y = Year
W = Work Week
▪ = Pb-Free Package

(*Note: Microdot may be in either location)

*Date Code orientation and/or position may vary depending upon manufacturing location.

PIN CONNECTION

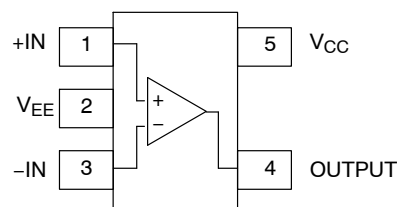

STYLE 3 PINOUT

ORDERING INFORMATION

See detailed ordering and shipping information in the dimensions section on page 11 of this data sheet.

LMV301

MAXIMUM RATINGS

Symbol	Rating	Value	Unit
V _S	Power Supply (Operating Voltage Range V _S = 1.8 V to 5.0 V)	5.5	V
V _{IDR}	Input Differential Voltage	±Supply Voltage	V
V _{ICR}	Input Common Mode Voltage Range	-0.5 to (V+) + 0.5	V
	Maximum Input Current	10	mA
t _{So}	Output Short Circuit (Note 1)	Continuous	
T _J	Maximum Junction Temperature (Operating Range -40°C to 85°C)	150	°C
J _A	Thermal Resistance (5-Pin SC70-5)	280	°C/W
T _{stg}	Storage Temperature	-65 to 150	°C
	Mounting Temperature (Infrared or Convection (30 sec))	260	
V _{ESD}	ESD Tolerance	100 1500	V
	Machine Model		
	Human Body Model		

Stresses exceeding Maximum Ratings may damage the device. Maximum Ratings are stress ratings only. Functional operation above the Recommended Operating Conditions is not implied. Extended exposure to stresses above the Recommended Operating Conditions may affect device reliability.

1. Continuous short-circuit to ground operation at elevated ambient temperature can result in exceeding the maximum allowed junction temperature of 150°C. Output currents in excess of 45 mA over long term may adversely affect reliability. Also, shorting output to V+ will adversely affect reliability; likewise shorting output to V- will adversely affect reliability.

LMV301

1.8 V DC ELECTRICAL CHARACTERISTICS (Unless otherwise specified, all limits are guaranteed for $T_A = 25^\circ\text{C}$, $V_{CC} = 1.8\text{ V}$, $R_L = 1\text{ M}\Omega$, $V_{EE} = 0\text{ V}$, $V_O = V_{CC}/2$)

Parameter	Symbol	Condition	Min	Typ	Max	Unit
Input Offset Voltage	V_{IO}	$T_A = -40^\circ\text{C to } +85^\circ\text{C}$		1.7	9	mV
Input Offset Voltage Average Drift	$T_C V_{IO}$	$T_A = -40^\circ\text{C to } +85^\circ\text{C}$		5		$\mu\text{V}/^\circ\text{C}$
Input Bias Current (Note 2)	I_B			3	35	pA
		$T_A = -40^\circ\text{C to } +85^\circ\text{C}$			50	
Common Mode Rejection Ratio	CMRR	$0\text{ V} \leq V_{CM} \leq 0.9\text{ V}$	50	63		dB
Power Supply Rejection Ratio	PSRR	$1.8\text{ V} \leq V_{CC} \leq 5\text{ V}$, $V_O = 1\text{ V}$, $V_{CM} = 1\text{ V}$	62	100		dB
Input Common-Mode Voltage Range	V_{CM}	For CMRR $\geq 50\text{ dB}$	0 to 0.9	-0.2 to 0.9		V
Large Signal Voltage Gain (Note 2)	A_V	$R_L = 600\Omega$	83	100		dB
		$T_A = -40^\circ\text{C to } +85^\circ\text{C}$	80			
		$R_L = 2\text{ k}\Omega$	83	100		
		$T_A = -40^\circ\text{C to } +85^\circ\text{C}$	80			
Output Swing	V_{OH}	$R_L = 600\Omega\text{ to } 0.9\text{ V}$ $T_A = -40^\circ\text{C to } +85^\circ\text{C}$	1.65 1.63			V
	V_{OL}	$R_L = 600\Omega\text{ to } 0.9\text{ V}$ $T_A = -40^\circ\text{C to } +85^\circ\text{C}$		75	100 120	mV
	V_{OH}	$R_L = 2\text{ k}\Omega\text{ to } 0.9\text{ V}$ $T_A = -40^\circ\text{C to } +85^\circ\text{C}$	1.5 1.4	1.76		V
	V_{OL}	$R_L = 2\text{ k}\Omega\text{ to } 0.9\text{ V}$ $T_A = -40^\circ\text{C to } +85^\circ\text{C}$		25	35 40	mV
Output Short Circuit Current (Note 2)	I_O	Sourcing = $V_O = 0\text{ V}$ Sinking = $V_O = 1.8\text{ V}$	10 20	60 160		mA
Supply Current	I_{CC}	$T_A = -40^\circ\text{C to } +85^\circ\text{C}$			185	μA

1.8 V AC ELECTRICAL CHARACTERISTICS (Unless otherwise specified, all limits are guaranteed for $T_A = 25^\circ\text{C}$, $V_{CC} = 1.8\text{ V}$, $R_L = 1\text{ M}\Omega$, $V_{EE} = 0\text{ V}$, $V_O = V_{CC}/2$)

Parameter	Symbol	Condition	Min	Typ	Max	Unit
Slew Rate	S_R			1		$\text{V}/\mu\text{s}$
Gain Bandwidth Product	GBWP	$C_L = 200\text{ pF}$		1		MHz
Phase Margin	Θ_m			60		$^\circ$
Gain Margin	G_m			10		dB
Input-Referred Voltage Noise	e_n	$f = 50\text{ kHz}$		50		$\text{nV}/\sqrt{\text{Hz}}$
Total Harmonic Distortion	THD	$A_V = +1$, $V - 1\text{ V}_{PP}$, $R_L = 10\text{ kW}$, $f = 1\text{ kHz}$		0.01		%

2. Guaranteed by design and/or characterization.

LMV301

2.7 V DC ELECTRICAL CHARACTERISTICS (Unless otherwise specified, all limits are guaranteed for $T_A = 25^\circ\text{C}$, $V_{CC} = 2.7\text{ V}$, $R_L = 1\text{ M}\Omega$, $V_{EE} = 0\text{ V}$, $V_O = V_{CC}/2$)

Parameter	Symbol	Condition	Min	Typ	Max	Unit
Input Offset Voltage	V_{IO}	$T_A = -40^\circ\text{C to } +85^\circ\text{C}$		1.7	9	mV
Input Offset Voltage Average Drift	$T_C V_{IO}$	$T_A = -40^\circ\text{C to } +85^\circ\text{C}$		5		$\mu\text{V}/^\circ\text{C}$
Input Bias Current (Note 2)	I_B			3	35	pA
		$T_A = -40^\circ\text{C to } +85^\circ\text{C}$			50	
Common Mode Rejection Ratio	CMRR	$0\text{ V} \leq V_{CM} \leq 1.35\text{ V}$	50	63		dB
Power Supply Rejection Ratio	PSRR	$1.8\text{ V} \leq V_{CC} \leq 5\text{ V}$, $V_O = 1\text{ V}$, $V_{CM} = 1\text{ V}$	62	100		dB
Input Common-Mode Voltage Range	V_{CM}	For CMRR $\geq 50\text{ dB}$	0 to 1.35	-0.2 to 1.35		V
Large Signal Voltage Gain (Note 2)	A_V	$R_L = 600\ \Omega$	83	100		dB
		$T_A = -40^\circ\text{C to } +85^\circ\text{C}$	80			
		$R_L = 2\text{ k}\Omega$	83	100		
		$T_A = -40^\circ\text{C to } +85^\circ\text{C}$	80			
Output Swing	V_{OH}	$R_L = 600\ \Omega$ to 1.35 V $T_A = -40^\circ\text{C to } +85^\circ\text{C}$	2.55 2.53	2.62		V
	V_{OL}	$R_L = 600\ \Omega$ to 1.35 V $T_A = -40^\circ\text{C to } +85^\circ\text{C}$		78	100 280	mV
	V_{OH}	$R_L = 2\text{ k}\Omega$ to 1.35 V $T_A = -40^\circ\text{C to } +85^\circ\text{C}$	2.65 2.64	2.675		V
	V_{OL}	$R_L = 2\text{ k}\Omega$ to 1.35 V $T_A = -40^\circ\text{C to } +85^\circ\text{C}$		75	100 110	mV
Output Short Circuit Current (Note 2)	I_O	Sourcing = $V_O = 0\text{ V}$ Sinking = $V_O = 2.7\text{ V}$	10 20	60 160		mA
Supply Current	I_{CC}	$T_A = -40^\circ\text{C to } +85^\circ\text{C}$			185	μA

2.7 V AC ELECTRICAL CHARACTERISTICS (Unless otherwise specified, all limits are guaranteed for $T_A = 25^\circ\text{C}$, $V_{CC} = 2.7\text{ V}$, $R_L = 1\text{ M}\Omega$, $V_{EE} = 0\text{ V}$, $V_O = V_{CC}/2$)

Parameter	Symbol	Condition	Min	Typ	Max	Unit
Slew Rate	S_R			1		$\text{V}/\mu\text{s}$
Gain Bandwidth Product	GBWP	$C_L = 200\text{ pF}$		1		MHz
Phase Margin	Θ_m			60		$^\circ$
Gain Margin	G_m			10		dB
Input-Referred Voltage Noise	e_n	$f = 50\text{ kHz}$		50		$\text{nV}/\sqrt{\text{Hz}}$
Total Harmonic Distortion	THD	$A_V = +1$, $V = 1\text{ V}_{PP}$, $R_L = 10\text{ k}\Omega$, $f = 1\text{ kHz}$		0.01		%

2. Guaranteed by design and/or characterization.

LMV301

5.0 V DC ELECTRICAL CHARACTERISTICS (Unless otherwise specified, all limits are guaranteed for $T_A = 25^\circ\text{C}$, $V_{CC} = 5.0\text{ V}$, $R_L = 1\text{ M}\Omega$, $V_{EE} = 0\text{ V}$, $V_O = V_{CC}/2$)

Parameter	Symbol	Condition	Min	Typ	Max	Unit
Input Offset Voltage	V_{IO}	$T_A = -40^\circ\text{C to } +85^\circ\text{C}$		1.7	9	mV
Input Offset Voltage Average Drift	$T_C V_{IO}$	$T_A = -40^\circ\text{C to } +85^\circ\text{C}$		5		$\mu\text{V}/^\circ\text{C}$
Input Bias Current (Note 2)	I_B			3	35	pA
		$T_A = -40^\circ\text{C to } +85^\circ\text{C}$			50	
Common Mode Rejection Ratio	CMRR	$0\text{ V} \leq V_{CM} \leq 4\text{ V}$	50	63		dB
Power Supply Rejection Ratio	PSRR	$1.8\text{ V} \leq V_{CC} \leq 5\text{ V}$, $V_O = 1\text{ V}$, $V_{CM} = 1\text{ V}$	62	100		dB
Input Common-Mode Voltage Range	V_{CM}	For CMRR $\geq 50\text{ dB}$	0 to 4	-0.2 to 4.2		V
Large Signal Voltage Gain (Note 2)	A_V	$R_L = 600\ \Omega$	83	100		dB
		$T_A = -40^\circ\text{C to } +85^\circ\text{C}$	80			
		$R_L = 2\text{ k}\Omega$	83	100		
		$T_A = -40^\circ\text{C to } +85^\circ\text{C}$	80			
Output Swing	V_{OH}	$R_L = 600\ \Omega$ to 2.5 V $T_A = -40^\circ\text{C to } +85^\circ\text{C}$	4.850 4.840			V
	V_{OL}	$R_L = 600\ \Omega$ to 2.5 V $T_A = -40^\circ\text{C to } +85^\circ\text{C}$			150 160	mV
	V_{OH}	$R_L = 2\text{ k}\Omega$ to 2.5 V $T_A = -40^\circ\text{C to } +85^\circ\text{C}$	4.935 4.900			V
	V_{OL}	$R_L = 2\text{ k}\Omega$ to 2.5 V $T_A = -40^\circ\text{C to } +85^\circ\text{C}$			65 75	mV
Output Short Circuit Current (Note 2)	I_O	Sourcing = $V_O = 0\text{ V}$ Sinking = $V_O = 5\text{ V}$	10 10	60 160		mA
Supply Current	I_{CC}	$T_A = -40^\circ\text{C to } +85^\circ\text{C}$			200	μA

5.0 V AC ELECTRICAL CHARACTERISTICS (Unless otherwise specified, all limits are guaranteed for $T_A = 25^\circ\text{C}$, $V_{CC} = 5.0\text{ V}$, $R_L = 1\text{ M}\Omega$, $V_{EE} = 0\text{ V}$, $V_O = V_{CC}/2$)

Parameter	Symbol	Condition	Min	Typ	Max	Unit
Slew Rate	S_R			1		$\text{V}/\mu\text{s}$
Gain Bandwidth Product	GBWP	$C_L = 200\text{ pF}$		1		MHz
Phase Margin	Θ_m			60		$^\circ$
Gain Margin	G_m			10		dB
Input-Referred Voltage Noise	e_n	$f = 50\text{ kHz}$		50		$\text{nV}/\sqrt{\text{Hz}}$
Total Harmonic Distortion	THD	$A_V = +1$, $V = 1\text{ V}_{PP}$, $R_L = 10\text{ kW}$, $f = 1\text{ kHz}$		0.01		%

2. Guaranteed by design and/or characterization.

LMV301

TYPICAL CHARACTERISTICS

($T_A = 25^\circ\text{C}$ and $V_S = 5\text{ V}$ unless otherwise specified)

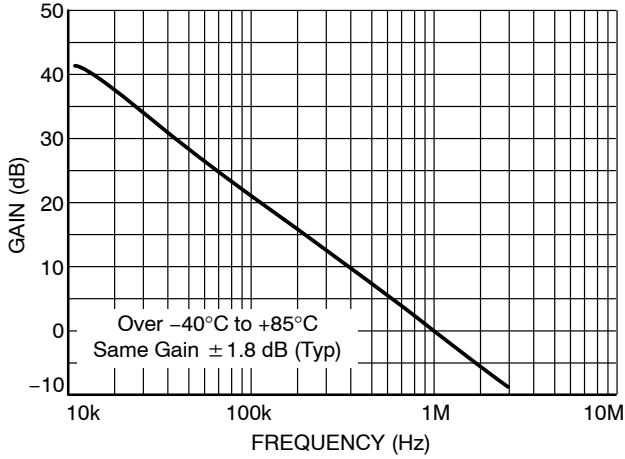

Figure 1. Open Loop Frequency Response
($R_L = 2\text{ k}\Omega$, $T_A = 25^\circ\text{C}$, $V_S = 5\text{ V}$)

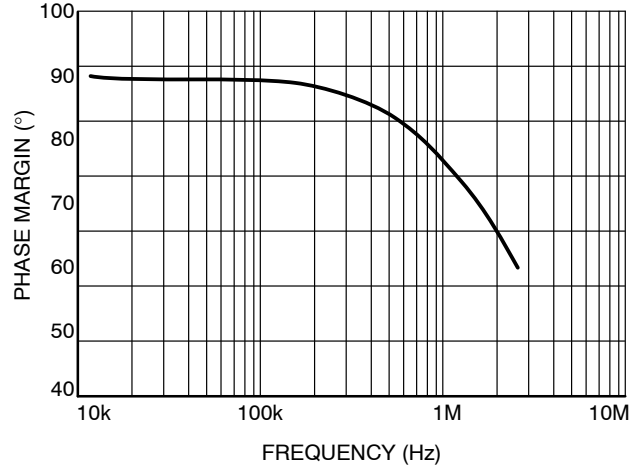

Figure 2. Open Loop Phase Margin
($R_L = 2\text{ k}\Omega$, $T_A = 25^\circ\text{C}$)

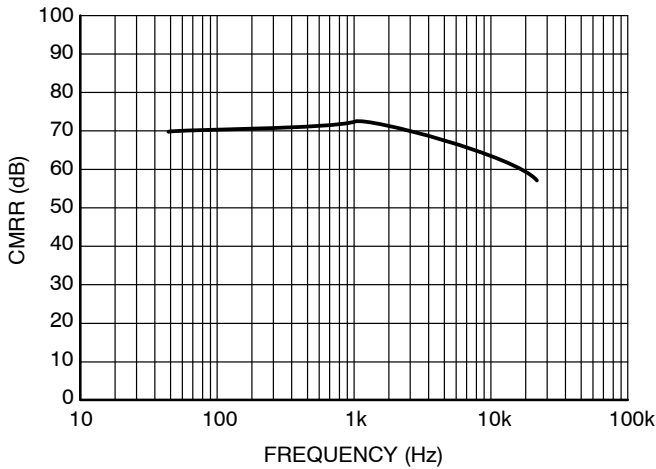

Figure 3. CMRR vs. Frequency
($R_L = 5\text{ k}\Omega$, $V_S = 5\text{ V}$)

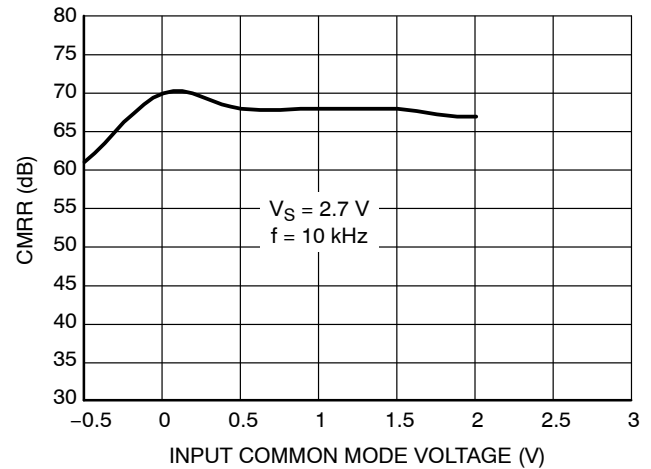

Figure 4. CMRR vs. Input Common Mode Voltage

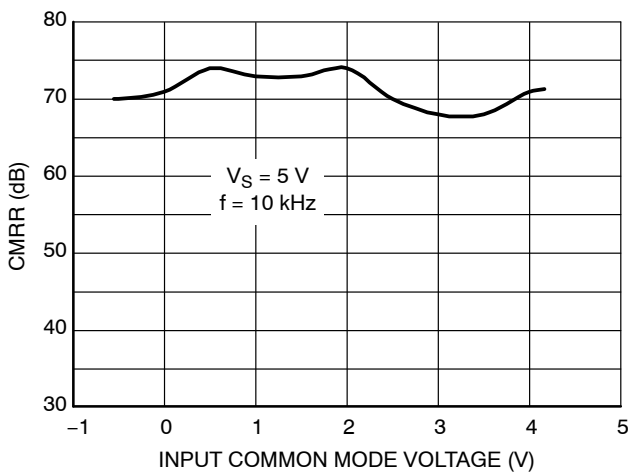

Figure 5. CMRR vs. Input Common Mode Voltage

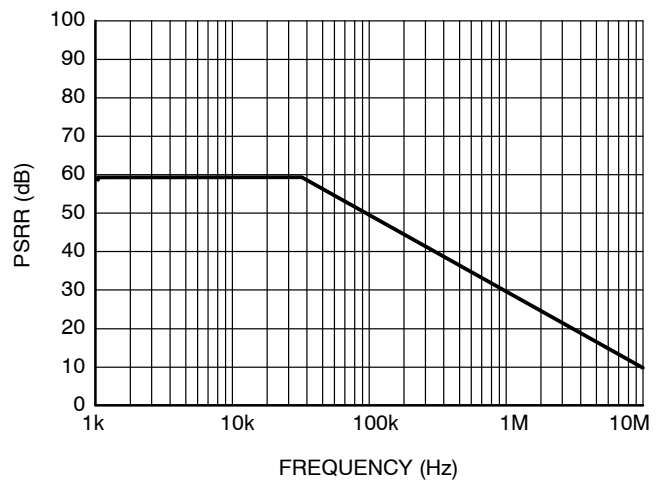

Figure 6. PSRR vs. Frequency
($R_L = 5\text{ k}\Omega$, $V_S = 2.7\text{ V}$, +PSRR)

LMV301

TYPICAL CHARACTERISTICS

($T_A = 25^\circ\text{C}$ and $V_S = 5\text{ V}$ unless otherwise specified)

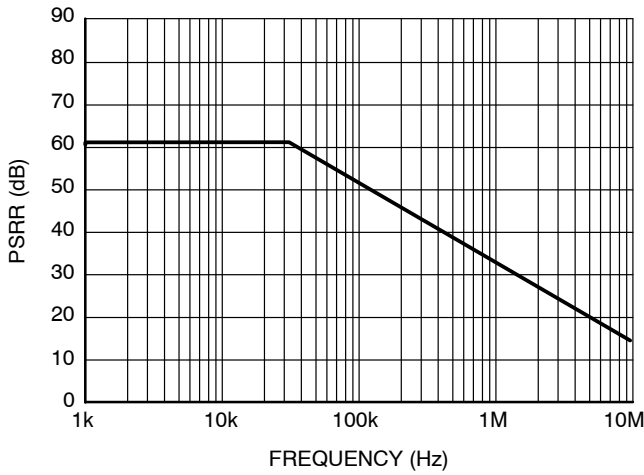

Figure 7. PSRR vs. Frequency
($R_L = 5\text{ k}\Omega$, $V_S = 2.7\text{ V}$, $-\text{PSRR}$)

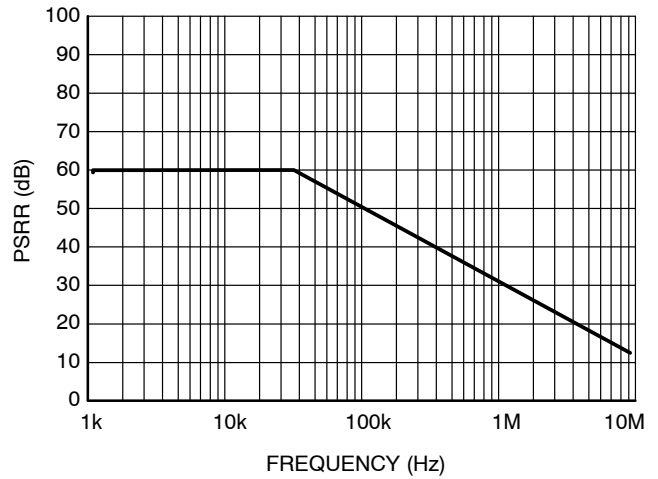

Figure 8. PSRR vs. Frequency
($R_L = 5\text{ k}\Omega$, $V_S = 5\text{ V}$, $+\text{PSRR}$)

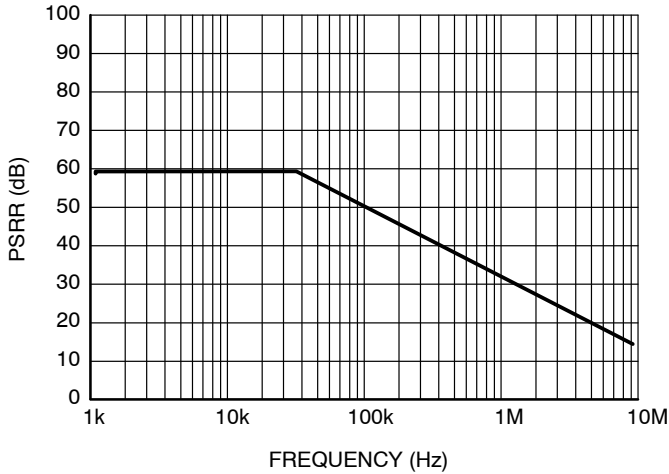

Figure 9. PSRR vs. Frequency
($R_L = 5\text{ k}\Omega$, $V_S = 5\text{ V}$, $-\text{PSRR}$)

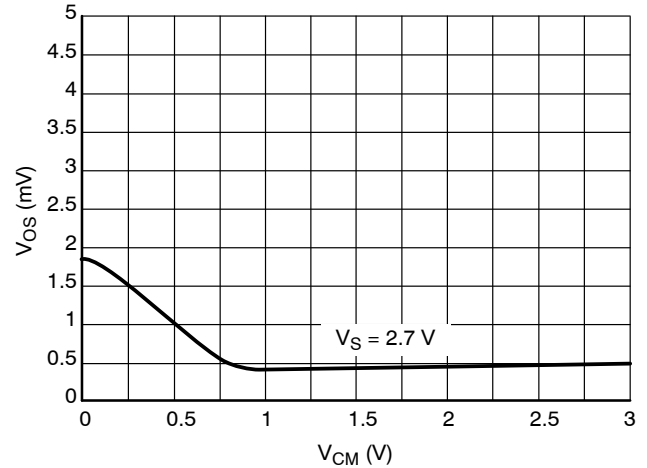

Figure 10. V_{OS} vs. CMR

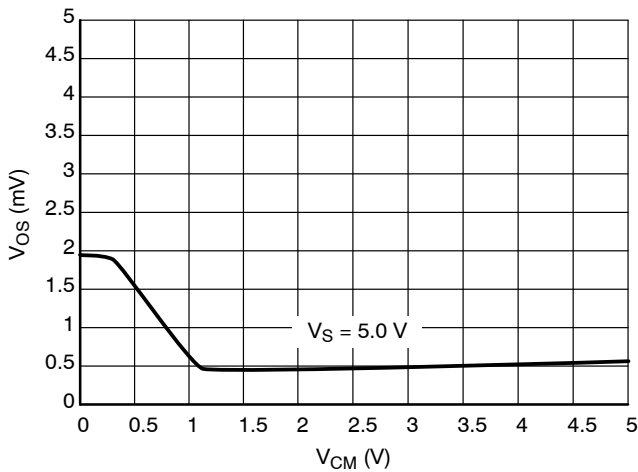

Figure 11. V_{OS} vs. CMR

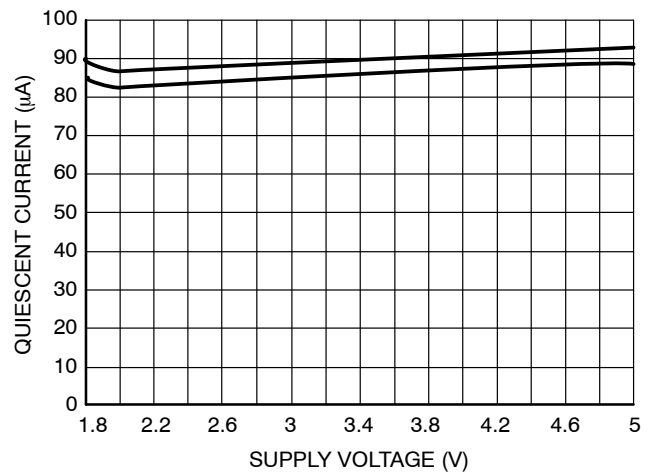

Figure 12. Supply Current vs. Supply Voltage

LMV301

TYPICAL CHARACTERISTICS

($T_A = 25^\circ\text{C}$ and $V_S = 5\text{ V}$ unless otherwise specified)

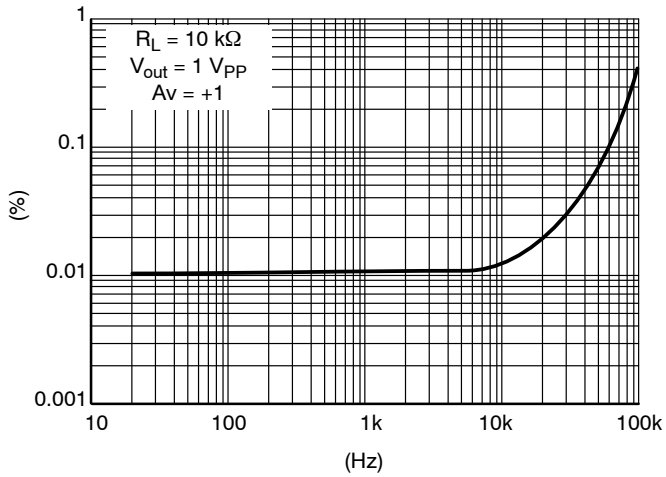

Figure 13. THD+N vs Frequency

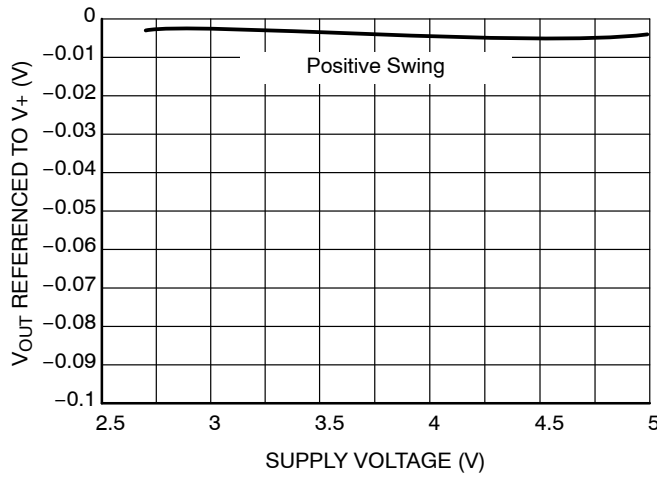

Figure 14. Output Voltage Swing vs Supply Voltage ($R_L = 10\text{ k}$)

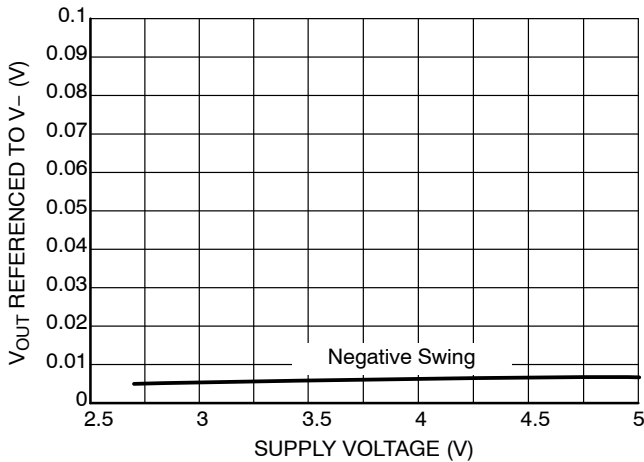

Figure 15. Output Voltage Swing vs Supply Voltage ($R_L = 10\text{ k}$)

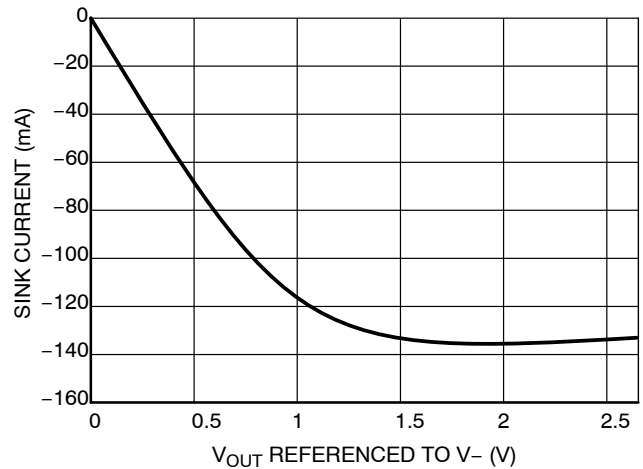

Figure 16. Sink Current vs. Output Voltage $V_S = 2.7\text{ V}$

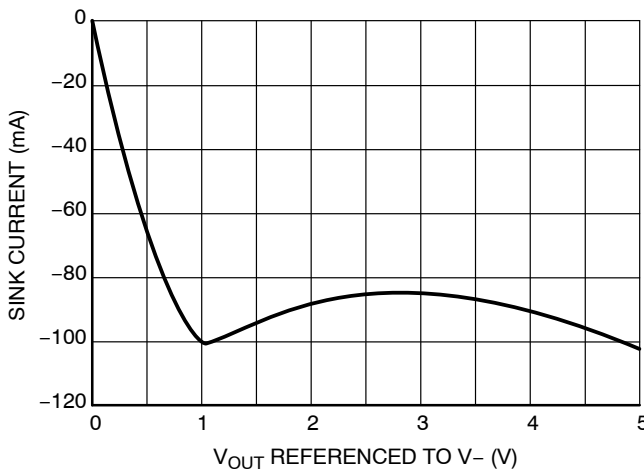

Figure 17. Sink Current vs. Output Voltage $V_S = 5.0\text{ V}$

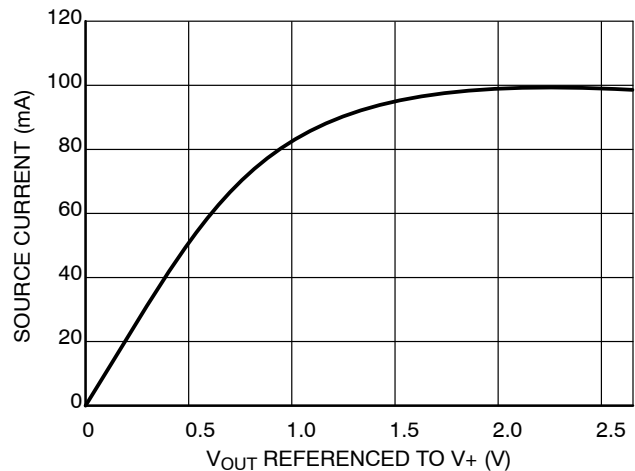

Figure 18. Source Current vs. Output Voltage $V_S = 2.7\text{ V}$

LMV301

TYPICAL CHARACTERISTICS

($T_A = 25^\circ\text{C}$ and $V_S = 5\text{ V}$ unless otherwise specified)

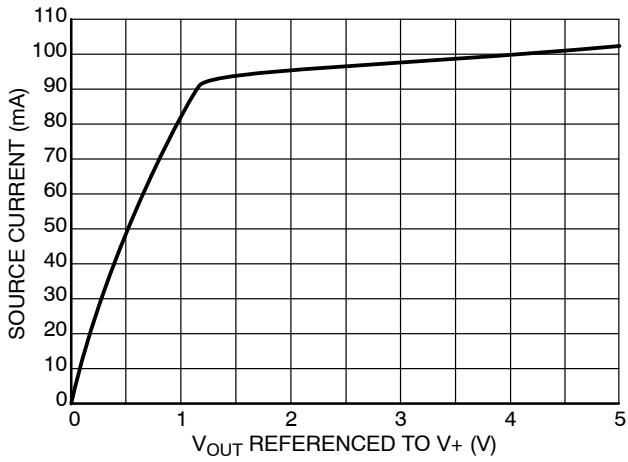

Figure 19. Source Current vs. Output Voltage
 $V_S = 5.0\text{ V}$

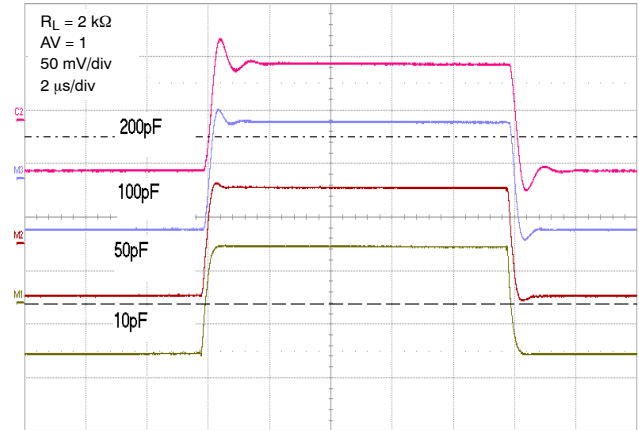

Figure 20. Settling Time vs. Capacitive Load

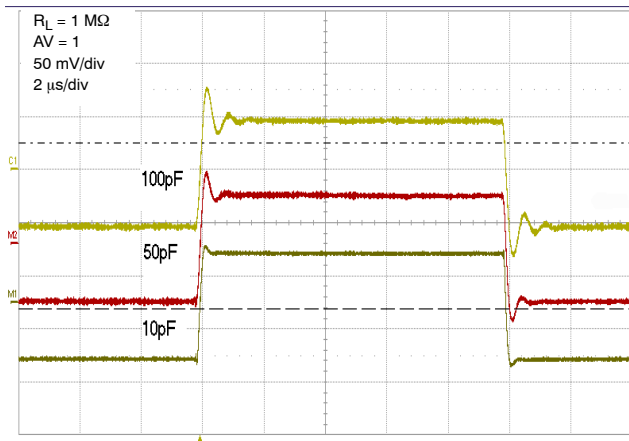

Figure 21. Settling Time vs. Capacitive Load

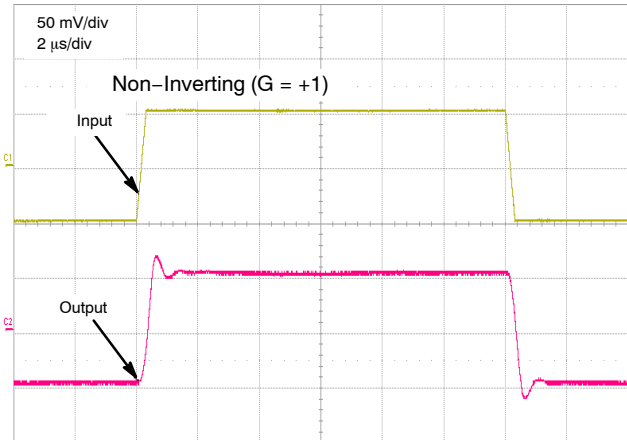

Figure 22. Step Response - Small Signal

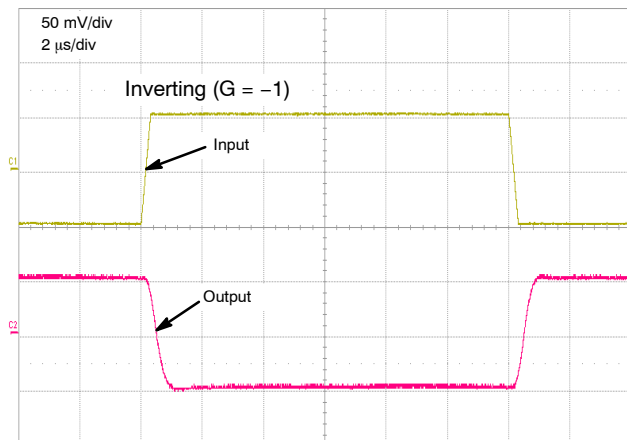

Figure 23. Step Response - Small Signal

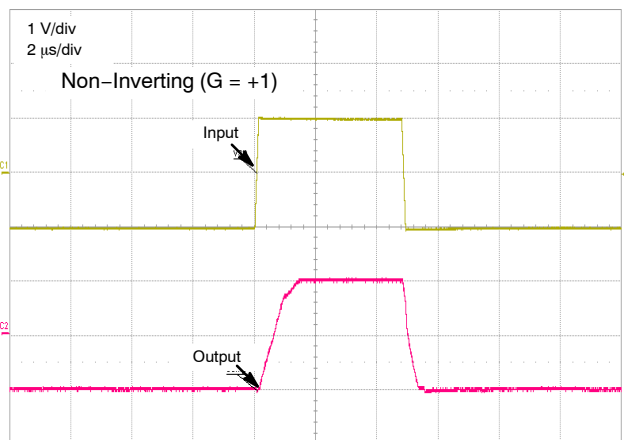

Figure 24. Step Response - Large Signal

LMV301

TYPICAL CHARACTERISTICS

($T_A = 25^\circ\text{C}$ and $V_S = 5\text{ V}$ unless otherwise specified)

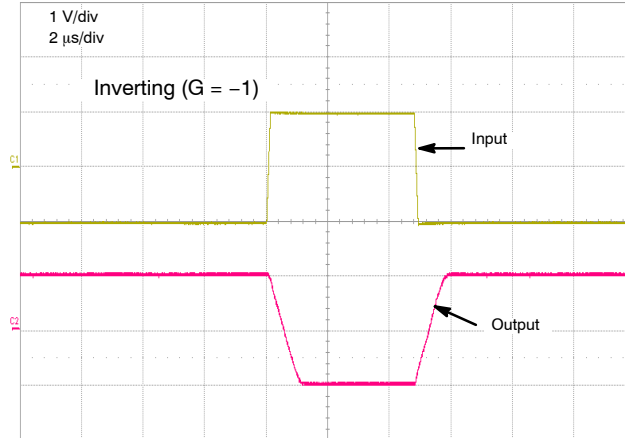

Figure 25. Step Response – Large Signal

LMV301

APPLICATIONS

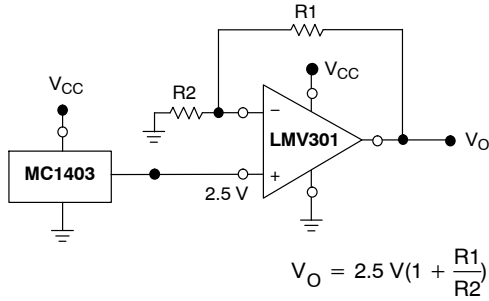

Figure 26. Voltage Reference

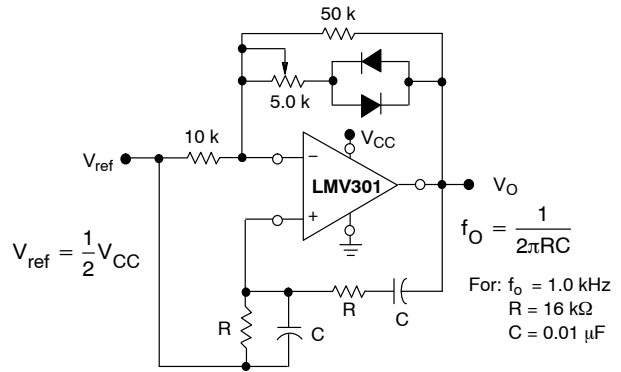

Figure 27. Wien Bridge Oscillator

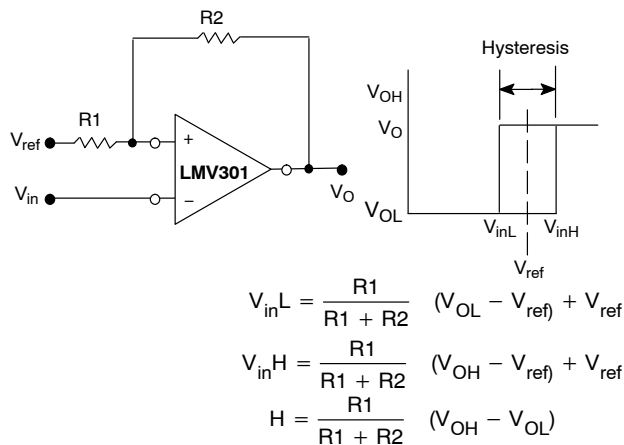
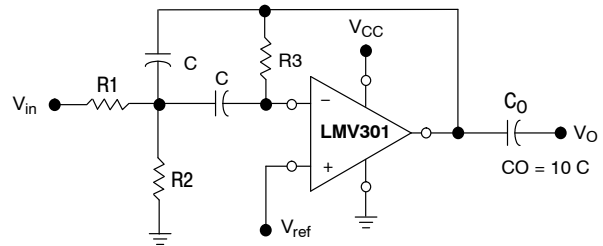

Figure 28. Comparator with Hysteresis



Given: f_o = center frequency
 $A(f_o)$ = gain at center frequency

Choose value f_o, C

$$\text{Then : } R3 = \frac{Q}{\pi f_o C}$$

$$R1 = \frac{R3}{2 A(f_o)}$$

$$R2 = \frac{R1 R3}{4Q^2 R1 - R3}$$

For less than 10% error from operational amplifier,
 $((Q_o f_o)/BW) < 0.1$ where f_o and BW are expressed in Hz.
 If source impedance varies, filter may be preceded with
 voltage follower buffer to stabilize filter parameters.

Figure 29. Multiple Feedback Bandpass Filter

ORDERING INFORMATION

Device	Pinout Style	Marking	Package	Shipping [†]
LMV301SQ3T2G	Style 3	AAC	SC70-5 (Pb-Free)	3000 / Tape & Reel
LMV301SN3T1G	Style 3	ADY	TSOP-5 (Pb-Free)	3000 / Tape & Reel

[†]For information on tape and reel specifications, including part orientation and tape sizes, please refer to our Tape and Reel Packaging Specifications Brochure, BRD8011/D.

LMV301

PACKAGE DIMENSIONS

SC-88A (SC-70-5/SOT-353)
CASE 419A-02
ISSUE K

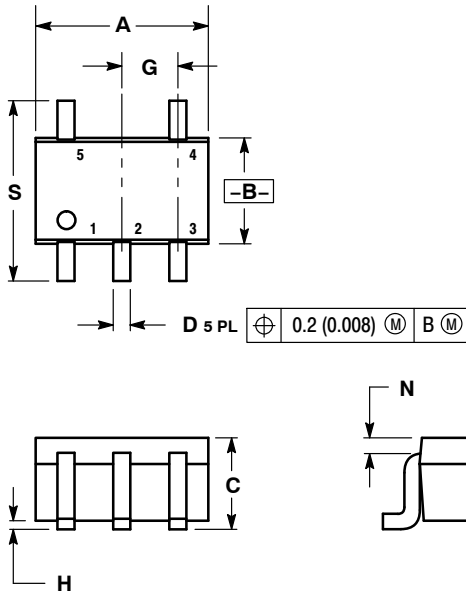

NOTES:

1. DIMENSIONING AND TOLERANCING PER ANSI Y14.5M, 1982.
2. CONTROLLING DIMENSION: INCH.
3. 419A-01 OBSOLETE. NEW STANDARD 419A-02.
4. DIMENSIONS A AND B DO NOT INCLUDE MOLD FLASH, PROTRUSIONS, OR GATE BURRS.

DIM	INCHES		MILLIMETERS	
	MIN	MAX	MIN	MAX
A	0.071	0.087	1.80	2.20
B	0.045	0.053	1.15	1.35
C	0.031	0.043	0.80	1.10
D	0.004	0.012	0.10	0.30
G	0.026 BSC		0.65 BSC	
H	---	0.004	---	0.10
J	0.004	0.010	0.10	0.25
K	0.004	0.012	0.10	0.30
N	0.008 REF		0.20 REF	
S	0.079	0.087	2.00	2.20

STYLE 2:

1. ANODE
2. EMITTER
3. BASE
4. COLLECTOR
5. CATHODE

STYLE 3:

1. ANODE 1
2. N/C
3. ANODE 2
4. CATHODE 2
5. CATHODE 1

SOLDERING FOOTPRINT*

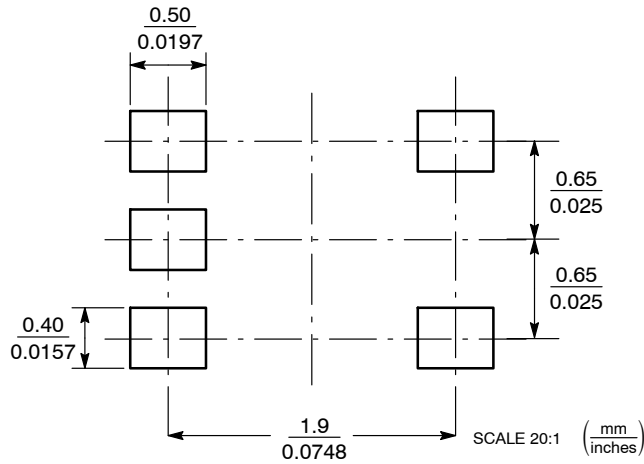

*For additional information on our Pb-Free strategy and soldering details, please download the ON Semiconductor Soldering and Mounting Techniques Reference Manual, SOLDERRM/D.

LMV301

PACKAGE DIMENSIONS

TSOP-5 CASE 483-02 ISSUE H

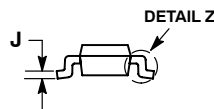
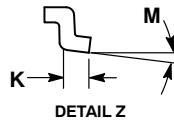
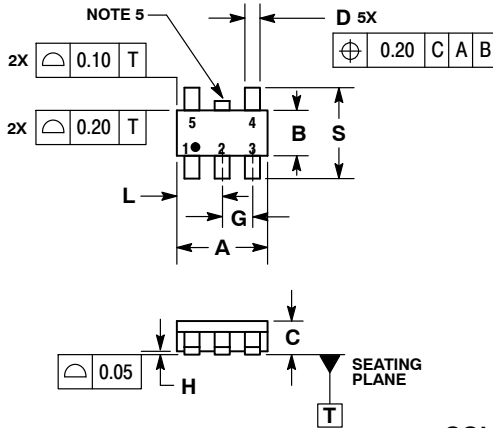

NOTES:

1. DIMENSIONING AND TOLERANCING PER ASME Y14.5M, 1994.
2. CONTROLLING DIMENSION: MILLIMETERS.
3. MAXIMUM LEAD THICKNESS INCLUDES LEAD FINISH THICKNESS. MINIMUM LEAD THICKNESS IS THE MINIMUM THICKNESS OF BASE MATERIAL.
4. DIMENSIONS A AND B DO NOT INCLUDE MOLD FLASH, PROTRUSIONS, OR GATE BURRS.
5. OPTIONAL CONSTRUCTION: AN ADDITIONAL TRIMMED LEAD IS ALLOWED IN THIS LOCATION. TRIMMED LEAD NOT TO EXTEND MORE THAN 0.2 FROM BODY.

DIM	MILLIMETERS	
	MIN	MAX
A	3.00 BSC	
B	1.50 BSC	
C	0.90	1.10
D	0.25	0.50
G	0.95 BSC	
H	0.01	0.10
J	0.10	0.26
K	0.20	0.60
L	1.25	1.55
M	0° 10°	
S	2.50	3.00

SOLDERING FOOTPRINT*

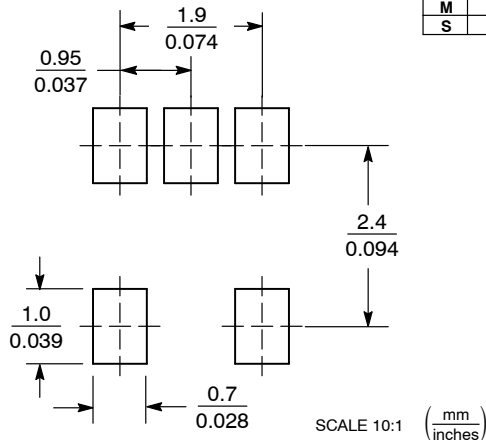

*For additional information on our Pb-Free strategy and soldering details, please download the ON Semiconductor Soldering and Mounting Techniques Reference Manual, SOLDERRM/D.

ON Semiconductor and are registered trademarks of Semiconductor Components Industries, LLC (SCILLC). SCILLC reserves the right to make changes without further notice to any products herein. SCILLC makes no warranty, representation or guarantee regarding the suitability of its products for any particular purpose, nor does SCILLC assume any liability arising out of the application or use of any product or circuit, and specifically disclaims any and all liability, including without limitation special, consequential or incidental damages. "Typical" parameters which may be provided in SCILLC data sheets and/or specifications can and do vary in different applications and actual performance may vary over time. All operating parameters, including "Typicals" must be validated for each customer application by customer's technical experts. SCILLC does not convey any license under its patent rights nor the rights of others. SCILLC products are not designed, intended, or authorized for use as components in systems intended for surgical implant into the body, or other applications intended to support or sustain life, or for any other application in which the failure of the SCILLC product could create a situation where personal injury or death may occur. Should Buyer purchase or use SCILLC products for any such unintended or unauthorized application, Buyer shall indemnify and hold SCILLC and its officers, employees, subsidiaries, affiliates, and distributors harmless against all claims, costs, damages, and expenses, and reasonable attorney fees arising out of, directly or indirectly, any claim of personal injury or death associated with such unintended or unauthorized use, even if such claim alleges that SCILLC was negligent regarding the design or manufacture of the part. SCILLC is an Equal Opportunity/Affirmative Action Employer. This literature is subject to all applicable copyright laws and is not for resale in any manner.

PUBLICATION ORDERING INFORMATION

LITERATURE FULFILLMENT:
Literature Distribution Center for ON Semiconductor
P.O. Box 5163, Denver, Colorado 80217 USA
Phone: 303-675-2175 or 800-344-3860 Toll Free USA/Canada
Fax: 303-675-2176 or 800-344-3867 Toll Free USA/Canada
Email: orderlit@onsemi.com

N. American Technical Support: 800-282-9855 Toll Free
USA/Canada
Europe, Middle East and Africa Technical Support:
Phone: 421 33 790 2910
Japan Customer Focus Center
Phone: 81-3-5817-1050

ON Semiconductor Website: www.onsemi.com
Order Literature: <http://www.onsemi.com/orderlit>
For additional information, please contact your local Sales Representative

Компания «Океан Электроники» предлагает заключение долгосрочных отношений при поставках импортных электронных компонентов на взаимовыгодных условиях!

Наши преимущества:

- Поставка оригинальных импортных электронных компонентов напрямую с производств Америки, Европы и Азии, а так же с крупнейших складов мира;
- Широкая линейка поставок активных и пассивных импортных электронных компонентов (более 30 млн. наименований);
- Поставка сложных, дефицитных, либо снятых с производства позиций;
- Оперативные сроки поставки под заказ (от 5 рабочих дней);
- Экспресс доставка в любую точку России;
- Помощь Конструкторского Отдела и консультации квалифицированных инженеров;
- Техническая поддержка проекта, помощь в подборе аналогов, поставка прототипов;
- Поставка электронных компонентов под контролем ВП;
- Система менеджмента качества сертифицирована по Международному стандарту ISO 9001;
- При необходимости вся продукция военного и аэрокосмического назначения проходит испытания и сертификацию в лаборатории (по согласованию с заказчиком);
- Поставка специализированных компонентов военного и аэрокосмического уровня качества (Xilinx, Altera, Analog Devices, Intersil, Interpoint, Microsemi, Actel, Aeroflex, Peregrine, VPT, Syfer, Eurofarad, Texas Instruments, MS Kennedy, Miteq, Cobham, E2V, MA-COM, Hittite, Mini-Circuits, General Dynamics и др.);

Компания «Океан Электроники» является официальным дистрибьютором и эксклюзивным представителем в России одного из крупнейших производителей разъемов военного и аэрокосмического назначения «JONHON», а так же официальным дистрибьютором и эксклюзивным представителем в России производителя высокотехнологичных и надежных решений для передачи СВЧ сигналов «FORSTAR».



JONHON

«JONHON» (основан в 1970 г.)

Разъемы специального, военного и аэрокосмического назначения:

(Применяются в военной, авиационной, аэрокосмической, морской, железнодорожной, горно- и нефтедобывающей отраслях промышленности)

«FORSTAR» (основан в 1998 г.)

ВЧ соединители, коаксиальные кабели, кабельные сборки и микроволновые компоненты:

(Применяются в телекоммуникациях гражданского и специального назначения, в средствах связи, РЛС, а так же военной, авиационной и аэрокосмической отраслях промышленности).



Телефон: 8 (812) 309-75-97 (многоканальный)

Факс: 8 (812) 320-03-32

Электронная почта: ocean@oceanchips.ru

Web: <http://oceanchips.ru/>

Адрес: 198099, г. Санкт-Петербург, ул. Калинина, д. 2, корп. 4, лит. А