

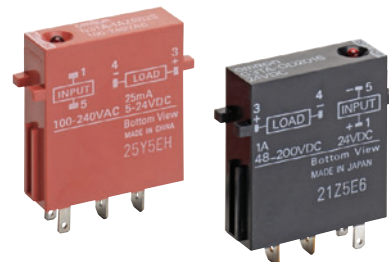

I/O SSRs That Mount to OMRON's G7TC I/O Block

- Input and output modules are available in wide variety.
- Snaps easily into P7TF I/O Terminals and can be used together with G7T I/O relays.
- Operation of each SSR can be monitored easily through an LED indicator.
- Models certified for UL and CSA added to the series ("-US" models).



 Refer to *Safety Precautions for All Solid State Relays*.

Model Number Structure

Model Number Legend

G3TA□□□□□□□□-□

1 2 3 4 5 6 7 8 9 10

1. Basic Model Name

G3T: I/O Solid State Relay

2. Structure

A: Socket type for PCB

3. I/O

I: Input models

O: Output models

4. Type

A: Input models: AC input
Output models: AC output

D: Input models: DC input
Output models: DC output

5. Rated Load Power Supply Voltage

2: 200 VAC/200 VDC

X: 50 to 100 V

Z: 26 V max.

6. Rated Load Current

01: 1 A

02: 2 A

R02: 25 mA

7. Terminal Type

S: Plug-in terminals

8. Zero Cross Function

Blank: DC output models

Z: Equipped with zero cross function

L: Not equipped with zero cross function

9. Operation Indicator

Blank: Equipped with operation indicator

M: Not equipped with operation indicator

10. Certification

US: Certified by UL and CSA

Ordering Information

List of Models

Input Modules

Isolation	Indicator	Logic level		Rated input voltage	Model
		Supply voltage	Supply current		
Photocoupler	Yes	4 to 32 VDC	25 mA	100 to 240 VAC	G3TA-IAZR02S-US
				5 to 24 VDC	G3TA-IDZR02S-US
	No		4 to 24 VDC	G3TA-IDZR02SM-US	

Note: When ordering, specify the rated input voltage.

Output Modules

Isolation	Zero cross function	Indicator	Rated output load	Rated input voltage	Model
Phototriac	Yes	Yes	2 A at 100 to 240 VAC at 60°C	12 VDC	G3TA-OA202SZ-US
				24 VDC	
	No			12 VDC	G3TA-OA202SL-US
				24 VDC	
Photocoupler	---	---	2 A at 5 to 48 VDC at 60°C	12 VDC	G3TA-ODX02S-US
				24 VDC	
			1 A at 48 to 200 VDC at 40°C	12 VDC	G3TA-OD201S-US
				24 VDC	

Note: 1. For information on products that are certified for international standards, consult your OMRON sales representatives. (Models certified for UL and CSA standards have "-US" at the end of the model number.)

2. Input Modules are mainly suitable for signal input to PLCs. For load switching, consider using an Output Module.

I/O Indication

The modules are classified as Input Modules and Output Modules according to the main application of the Module. I/O module classification and AC/DC use are indicated on the mark affixed to the top of the product.

Mark attached to the top of product



Mark indication	Specification
AC IN	Input module, AC input
DC IN	Input module, DC input
AC OUT	Output module, AC output
DC OUT	Output module, DC output

■ Accessories (Order Separately)

Connecting Socket

I/O classification	Rated voltage	Model
Input (NPN, – common)	12 VDC	P7TF-IS16
	24 VDC	
	100/110 VDC	
	100/110 VAC	
	200/220 VAC	
Output (NPN, + common)	12 VDC	P7TF-OS16
	24 VDC	
Output (PNP, – common)	12 VDC	P7TF-OS16-1
	24 VDC	
Output (NPN, + common)	12 VDC	P7TF-OS08
	24 VDC	
---	---	P7TF-05

Specifications

■ Ratings (at an Ambient Temperature of 25°C)

Input Module

Input

Model	Rated voltage	Operating voltage	Input current	Voltage level	
				Must operate voltage	Must release voltage
G3TA-IAZR02S-US	100 to 240 VAC	80 to 264 VAC	5 mA max.	80 VAC max.	10 VAC min.
G3TA-IDZR02S-US	5 to 24 VDC	4 to 32 VDC		4 VDC max.	
G3TA-IDZR02SM-US	4 to 24 VDC	3 to 32 VDC		3 VDC max.	1 VDC min.

Output

Model	Logic level supply voltage	Output breakdown voltage	Output current	Output current (load current)	V _{CEO} (reference value)
G3TA-IAZR02S-US	4 to 32 VDC	32 VDC max.	25 mA max.	0.1 to 25 mA	80 V
G3TA-IDZR02S-US					
G3TA-IDZR02SM-US					

Output Module

Input

Model	Rated voltage	Operating voltage	Input impedance	Voltage level	
				Must operate voltage	Must release voltage
G3TA-OA202SZ-US	12 VDC	9.6 to 13.2 VDC	0.9 kΩ±20%	9.6 VDC max.	2 VDC min.
	24 VDC	19.2 to 26.4 VDC	1.7 kΩ±20%	19.2 VDC max.	
G3TA-OA202SL-US	12 VDC	9.6 to 13.2 VDC	0.9 kΩ±20%	9.6 VDC max.	
	24 VDC	19.2 to 26.4 VDC	1.7 kΩ±20%	19.2 VDC max.	
G3TA-ODX02S-US	12 VDC	9.6 to 13.2 VDC	3.5 kΩ±20%	9.6 VDC max.	
	24 VDC	19.2 to 26.4 VDC	6.5 kΩ±20%	19.2 VDC max.	
G3TA-OD201S-US	12 VDC	9.6 to 13.2 VDC	3.6 kΩ±20%	9.6 VDC max.	
	24 VDC	19.2 to 26.4 VDC	6.4 kΩ±20%	19.2 VDC max.	

Output

Model	Rated load voltage	Load voltage range	Load current (See note.)	Inrush current	V _{DRM} , V _{CEO} (reference value)
G3TA-OA202SZ-US	100 to 240 VAC	75 to 264 VAC	0.05 to 2 A	30 A (60 Hz, 1 cycle)	600 (V _{DRM})
G3TA-OA202SL-US	100 to 240 VAC	75 to 264 VAC			
G3TA-ODX02S-US	5 to 48 VDC	4 to 60 VDC	0.01 to 2 A	12 A (10 ms)	80 (V _{CEO})
G3TA-OD201S-US	48 to 200 VDC	40 to 200 VDC	0.01 to 1 A	6 A (10 ms)	400 (V _{CEO})

Note: The minimum current value is measured at 10°C min.

■ Characteristics

Input Module

Item	G3TA-IAZR02S-US	G3TA-IDZR02S-US	G3TA-IDZR02SM-US
Operate time	20 ms max.	0.5 ms max.	
Release time	20 ms max.	0.5 ms max.	
Output ON voltage drop	1.6 V max.	1.6 V max.	
Leakage current	5 μ A max.		
Insulation resistance	100 M Ω min. (at 500 VDC)		
Dielectric strength	4,000 VAC, 50/60 Hz for 1 min between input and output		
Vibration resistance	Malfunction: 10 to 55 to 10 Hz, 0.75-mm single amplitude		
Shock resistance	Malfunction: 1,000 m/s ²		
Ambient temperature	Operating: -30°C to 80°C (with no icing or condensation) Storage: -30°C to 100°C (with no icing or condensation)		
Ambient humidity	Operating: 45% to 85%		
Certified standards	UL508 file No. E64562/CSA C22.2 (No. 0, No. 14) file No. LR35535		
Weight	Approx. 16 g		

Output Module

Item	G3TA-OA202SZ-US	G3TA-OA202SL-US	G3TA-ODX02S-US	G3TA-OD201S-US
Operate time	1/2 of load power source cycle + 1 ms max.	1 ms max.	0.5 ms max.	2 ms max.
Release time	1/2 of load power source cycle + 1 ms max.		2 ms max.	2 ms max.
Output ON voltage drop	1.6 V rms max.		1.6 V max.	2.5 V max.
Leakage current	5 mA max. (at 200 VAC)		1 mA max.	
Insulation resistance	100 M Ω min. (at 500 VDC)			
Dielectric strength	4,000 VAC, 50/60 Hz for 1 min between input and output			
Vibration resistance	Malfunction: 10 to 55 to 10 Hz, 0.75-mm single amplitude			
Shock resistance	Malfunction: 1,000 m/s ²			
Ambient temperature	Operating: -30°C to 80°C (with no icing or condensation) Storage: -30°C to 100°C (with no icing or condensation)			
Ambient humidity	Operating: 45% to 85%			
Certified standards	UL508 file No. E64562, CSA C22.2 (No. 14) file No. LR3553			
Weight	Approx. 23 g			

With up to four G3TA SSRs mounted before G7T Relays, switching is possible at the rated load current for each Relay.



With G3TA SSRs mounted before every other G7T Relays, switching is possible at the rated load current for each Relay.

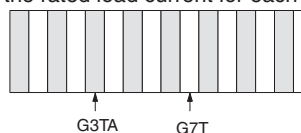

Engineering Data

Load Current vs. Ambient Temperature Characteristics

G3TA-OA202SZ/OA202SL/ODX02S-US

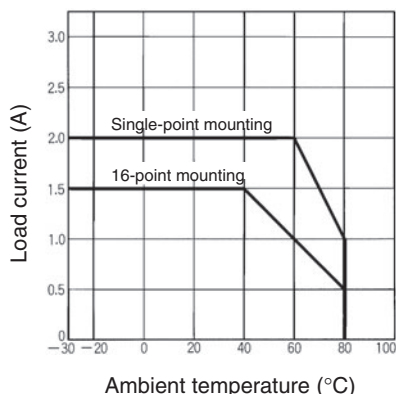

G3TA-OD201S-US

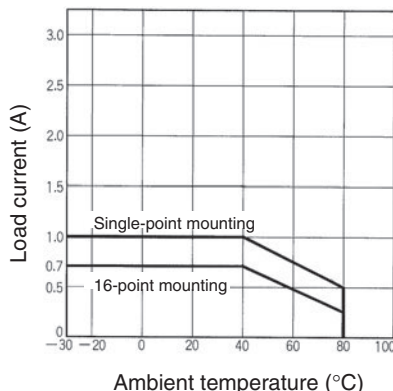

One Cycle Surge Current: Non-repetitive

Non-repetitive (Keep the inrush current to half the rated value if it occurs repetitively.)

G3TA-OA202SZ/OA202SL-US

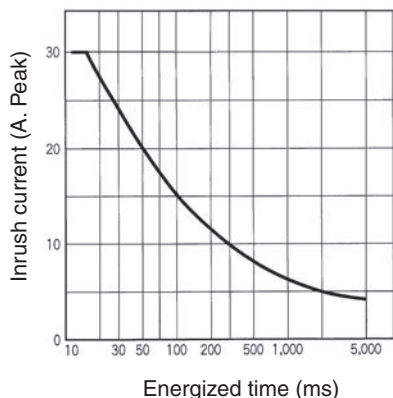

G3TA-ODX02S-US

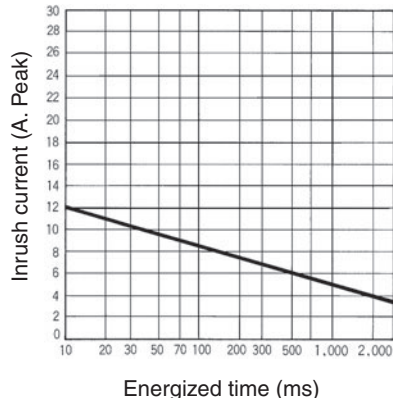

G3TA-OD201S-US

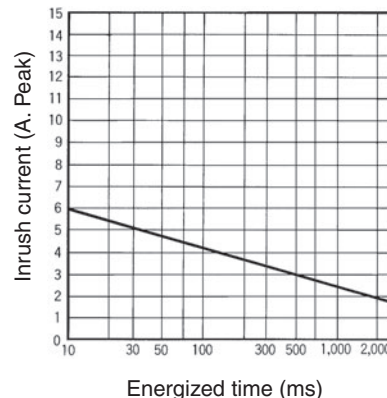

Connections

External Connections (Bottom View)

G3TA-IAZR02S

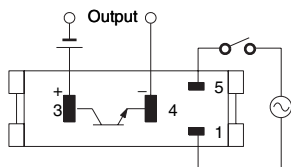

G3TA-IDZR02S/IDZR02SM

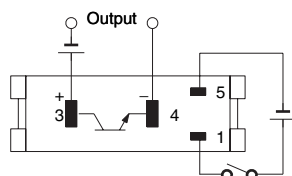

G3TA-OA

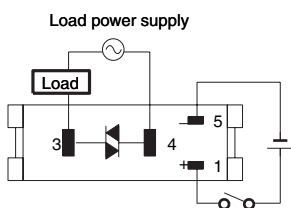

G3TA-OD

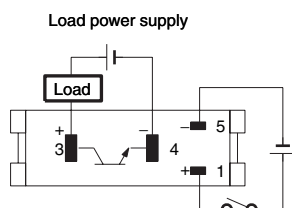

Note: The load is possible to connect either + side or - side.

Circuit Configurations

	Model	Case color	Operation indicator	Circuit
AC output	G3TA-OA202SZ (with zero cross) G3TA-OA202SL (without zero cross)	Black	yes	
DC output	G3TA-ODX02S G3TA-OD201S	Black	yes	
AC input	G3TA-IAZR02S	Red	yes	
DC input	G3TA-IDZR02S	Green	yes	
	G3TA-IDZR02SM		No	

Dimensions

Note: All units are in millimeters unless otherwise indicated.

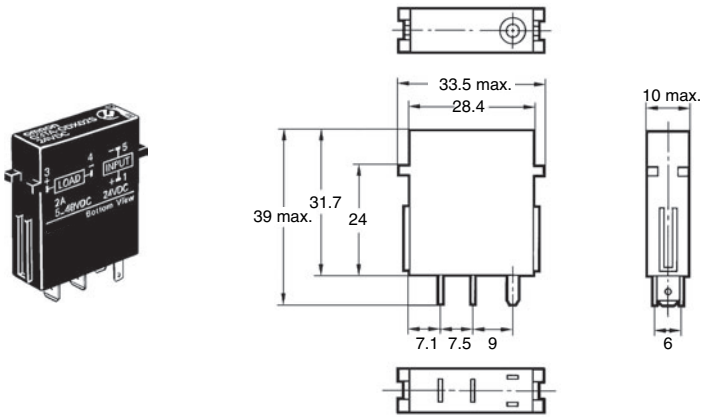

Connecting Sockets

For Input (NPN, - Common)
P7TF-IS16

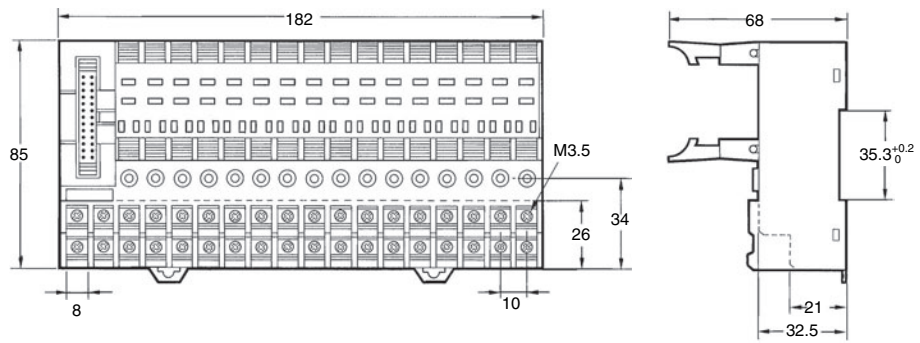
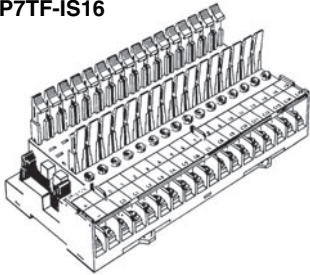

**For Output (NPN, + Common)
P7TF-OS16**

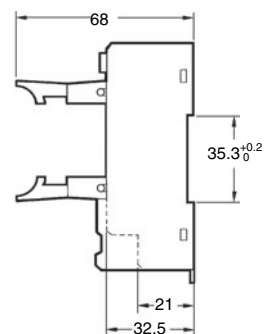
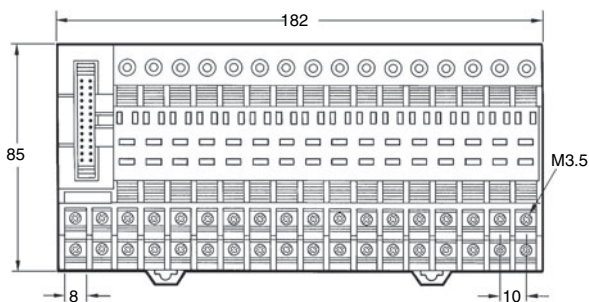
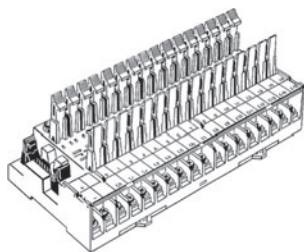

**For Output (PNP, + Common)
P7TF-OS08**

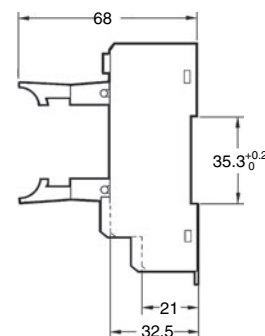
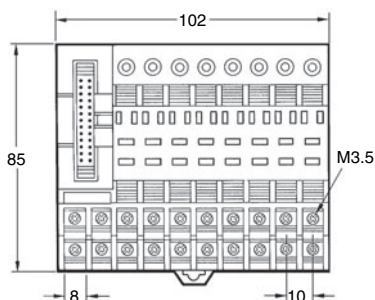
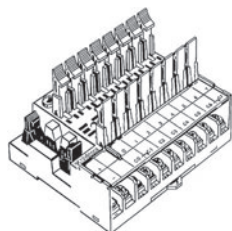

P7TF-O5

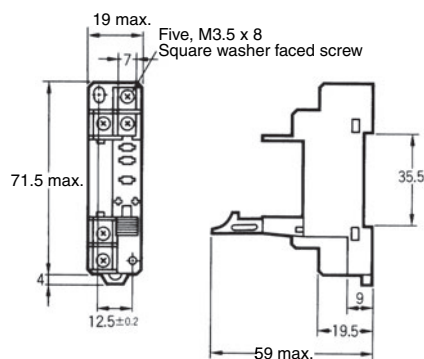
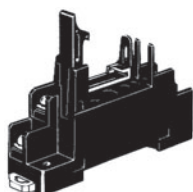

Safety Precautions

Refer to *Safety Precautions for All Solid State Relays*.

■ Precautions for Correct Use

Please observe the following precautions to prevent failure to operate, malfunction, or undesirable effect on product performance.

Connection

With the SSR for DC switching, the load can be connected to either positive or negative output terminal of the SSR.

Protective Component

Since the SSR does not incorporate an overvoltage absorption component, be sure to connect an overvoltage absorption component when using the SSR under an inductive load.

ALL DIMENSIONS SHOWN ARE IN MILLIMETERS.

To convert millimeters into inches, multiply by 0.03937. To convert grams into ounces, multiply by 0.03527.

In the interest of product improvement, specifications are subject to change without notice.

Read and Understand This Catalog

Please read and understand this catalog before purchasing the products. Please consult your OMRON representative if you have any questions or comments.

Warranty and Limitations of Liability

WARRANTY

OMRON's exclusive warranty is that the products are free from defects in materials and workmanship for a period of one year (or other period if specified) from date of sale by OMRON.

OMRON MAKES NO WARRANTY OR REPRESENTATION, EXPRESS OR IMPLIED, REGARDING NON-INFRINGEMENT, MERCHANTABILITY, OR FITNESS FOR PARTICULAR PURPOSE OF THE PRODUCTS. ANY BUYER OR USER ACKNOWLEDGES THAT THE BUYER OR USER ALONE HAS DETERMINED THAT THE PRODUCTS WILL SUITABLY MEET THE REQUIREMENTS OF THEIR INTENDED USE. OMRON DISCLAIMS ALL OTHER WARRANTIES, EXPRESS OR IMPLIED.

LIMITATIONS OF LIABILITY

OMRON SHALL NOT BE RESPONSIBLE FOR SPECIAL, INDIRECT, OR CONSEQUENTIAL DAMAGES, LOSS OF PROFITS OR COMMERCIAL LOSS IN ANY WAY CONNECTED WITH THE PRODUCTS, WHETHER SUCH CLAIM IS BASED ON CONTRACT, WARRANTY, NEGLIGENCE, OR STRICT LIABILITY.

In no event shall the responsibility of OMRON for any act exceed the individual price of the product on which liability is asserted.

IN NO EVENT SHALL OMRON BE RESPONSIBLE FOR WARRANTY, REPAIR, OR OTHER CLAIMS REGARDING THE PRODUCTS UNLESS OMRON'S ANALYSIS CONFIRMS THAT THE PRODUCTS WERE PROPERLY HANDLED, STORED, INSTALLED, AND MAINTAINED AND NOT SUBJECT TO CONTAMINATION, ABUSE, MISUSE, OR INAPPROPRIATE MODIFICATION OR REPAIR.

Application Considerations

SUITABILITY FOR USE

OMRON shall not be responsible for conformity with any standards, codes, or regulations that apply to the combination of products in the customer's application or use of the products.

At the customer's request, OMRON will provide applicable third party certification documents identifying ratings and limitations of use that apply to the products. This information by itself is not sufficient for a complete determination of the suitability of the products in combination with the end product, machine, system, or other application or use.

The following are some examples of applications for which particular attention must be given. This is not intended to be an exhaustive list of all possible uses of the products, nor is it intended to imply that the uses listed may be suitable for the products:

- Outdoor use, uses involving potential chemical contamination or electrical interference, or conditions or uses not described in this catalog.
- Nuclear energy control systems, combustion systems, railroad systems, aviation systems, medical equipment, amusement machines, vehicles, safety equipment, and installations subject to separate industry or government regulations.
- Systems, machines, and equipment that could present a risk to life or property.

Please know and observe all prohibitions of use applicable to the products.

NEVER USE THE PRODUCTS FOR AN APPLICATION INVOLVING SERIOUS RISK TO LIFE OR PROPERTY WITHOUT ENSURING THAT THE SYSTEM AS A WHOLE HAS BEEN DESIGNED TO ADDRESS THE RISKS, AND THAT THE OMRON PRODUCTS ARE PROPERLY RATED AND INSTALLED FOR THE INTENDED USE WITHIN THE OVERALL EQUIPMENT OR SYSTEM.

PROGRAMMABLE PRODUCTS

OMRON shall not be responsible for the user's programming of a programmable product, or any consequence thereof.

Disclaimers

CHANGE IN SPECIFICATIONS

Product specifications and accessories may be changed at any time based on improvements and other reasons.

It is our practice to change model numbers when published ratings or features are changed, or when significant construction changes are made. However, some specifications of the products may be changed without any notice. When in doubt, special model numbers may be assigned to fix or establish key specifications for your application on your request. Please consult with your OMRON representative at any time to confirm actual specifications of purchased products.

DIMENSIONS AND WEIGHTS

Dimensions and weights are nominal and are not to be used for manufacturing purposes, even when tolerances are shown.

PERFORMANCE DATA

Performance data given in this catalog is provided as a guide for the user in determining suitability and does not constitute a warranty. It may represent the result of OMRON's test conditions, and the users must correlate it to actual application requirements. Actual performance is subject to the OMRON Warranty and Limitations of Liability.

ERRORS AND OMISSIONS

The information in this document has been carefully checked and is believed to be accurate; however, no responsibility is assumed for clerical, typographical, or proofreading errors, or omissions.

2011.4

In the interest of product improvement, specifications are subject to change without notice.

OMRON Corporation
Industrial Automation Company

<http://www.ia.omron.com/>

(c)Copyright OMRON Corporation 2011 All Right Reserved.

Mouser Electronics

Authorized Distributor

Click to View Pricing, Inventory, Delivery & Lifecycle Information:

Omron:

[G3TA-OA202SZ-US DC12](#) [G3TA-IDZR02S DC5-24](#) [G3TA-OA202SZ-US DC24](#) [G3TA-OA202SL-US DC24](#) [G3TA-OA202SZ DC24](#) [G3TA-OD201S DC24](#)

Компания «Океан Электроники» предлагает заключение долгосрочных отношений при поставках импортных электронных компонентов на взаимовыгодных условиях!

Наши преимущества:

- Поставка оригинальных импортных электронных компонентов напрямую с производств Америки, Европы и Азии, а так же с крупнейших складов мира;
- Широкая линейка поставок активных и пассивных импортных электронных компонентов (более 30 млн. наименований);
- Поставка сложных, дефицитных, либо снятых с производства позиций;
- Оперативные сроки поставки под заказ (от 5 рабочих дней);
- Экспресс доставка в любую точку России;
- Помощь Конструкторского Отдела и консультации квалифицированных инженеров;
- Техническая поддержка проекта, помощь в подборе аналогов, поставка прототипов;
- Поставка электронных компонентов под контролем ВП;
- Система менеджмента качества сертифицирована по Международному стандарту ISO 9001;
- При необходимости вся продукция военного и аэрокосмического назначения проходит испытания и сертификацию в лаборатории (по согласованию с заказчиком);
- Поставка специализированных компонентов военного и аэрокосмического уровня качества (Xilinx, Altera, Analog Devices, Intersil, Interpoint, Microsemi, Actel, Aeroflex, Peregrine, VPT, Syfer, Eurofarad, Texas Instruments, MS Kennedy, Miteq, Cobham, E2V, MA-COM, Hittite, Mini-Circuits, General Dynamics и др.);

Компания «Океан Электроники» является официальным дистрибьютором и эксклюзивным представителем в России одного из крупнейших производителей разъемов военного и аэрокосмического назначения «JONHON», а так же официальным дистрибьютором и эксклюзивным представителем в России производителя высокотехнологичных и надежных решений для передачи СВЧ сигналов «FORSTAR».



JONHON

«JONHON» (основан в 1970 г.)

Разъемы специального, военного и аэрокосмического назначения:

(Применяются в военной, авиационной, аэрокосмической, морской, железнодорожной, горно- и нефтедобывающей отраслях промышленности)

«FORSTAR» (основан в 1998 г.)

ВЧ соединители, коаксиальные кабели, кабельные сборки и микроволновые компоненты:

(Применяются в телекоммуникациях гражданского и специального назначения, в средствах связи, РЛС, а так же военной, авиационной и аэрокосмической отраслях промышленности).



Телефон: 8 (812) 309-75-97 (многоканальный)

Факс: 8 (812) 320-03-32

Электронная почта: ocean@oceanchips.ru

Web: <http://oceanchips.ru/>

Адрес: 198099, г. Санкт-Петербург, ул. Калинина, д. 2, корп. 4, лит. А