

## Receiver 31 - 36 GHz

Rev. V1

### Features

- Integrated LNA, Mixer and LO Buffer Amplifier
- 3 dB Noise Figure
- 14 dB Conversion Gain
- Lead-Free 4 mm PQFN 24-lead Package
- RoHS\* Compliant

### Description

The XR1020-QH is a 31 - 36 GHz receiver that has a noise figure of 3 dB and 14 dB conversion gain. The device integrates an LNA, image reject mixer and LO buffer amplifier within a fully molded lead-free 4 mm 24-lead PQFN package.

The image reject mixer eliminates the need for a bandpass filter after the LNA to remove thermal noise at the image frequency. I and Q mixer outputs are provided and an external 90° hybrid is required to select the desired sideband.

This device is well suited for Point-to-Point Radio, SATCOM and Military applications.

### Ordering Information<sup>1,2</sup>

Part Number	Package
XR1020-QH-A000	bulk quantity
XR1020-QH-TR0500	500 piece reel
XR1020-QH-TR1000	1000 piece reel
XR1020-QH-EV1	evaluation module

1. Reference Application Note M513 for reel size information.
2. All sample boards include 5 loose parts.

\*Restrictions on Hazardous Substances, European Union Directive 2011/65/EU.

### Functional Schematic

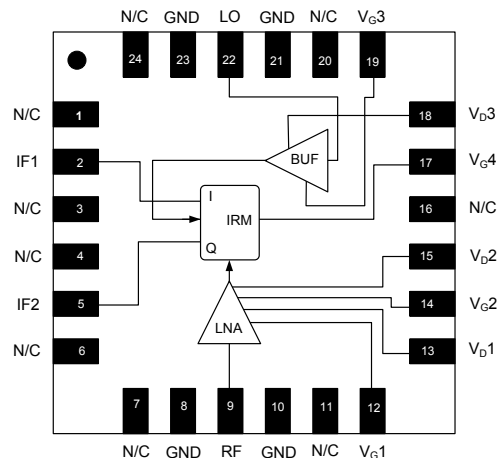

### Pin Configuration<sup>3</sup>

Pin No.	Function	Function
1	N/C	No Connection
2	IF1	IF1 Output
3	N/C	No Connection
4	N/C	No Connection
5	IF2	IF2 Output
6	N/C	No Connection
7	N/C	No Connection
8	GND	Ground
9	RF	RF Input
10	GND	Ground
11	N/C	No Connection
12	V <sub>G</sub> 1	Gate LNA Stage 1
13	V <sub>D</sub> 1	Drain LNA Stage 1
14	V <sub>G</sub> 2	Gate LNA Stage 2
15	V <sub>D</sub> 2	Drain LNA Stage 2
16	N/C	No Connection
17	V <sub>G</sub> 4	Mixer Bias
18	V <sub>D</sub> 3	Drain, LO Buffer
19	V <sub>G</sub> 3	Gate, LO Buffer
20	N/C	No Connection
21	GND	Ground
22	LO	LO Input
23	GND	Ground
24	N/C	No Connection
25 <sup>4</sup>	Paddle	Ground

3. MACOM recommends connecting unused package pins to ground.
4. The exposed pad centered on the package bottom must be connected to RF and DC ground.

Electrical Specifications:<sup>5</sup>  $T_B = +25^\circ\text{C}$ ,  $V_{D1,2,3} = 3\text{ V}$ ,  $V_{G4} = -3\text{ V}$ ,  $IF = 2\text{ GHz}$

Parameter	Units	Min.	Typ.	Max.
Frequency Range (RF)	GHz	31	-	36
Frequency Range (LO)	GHz	27.5	-	39.5
Frequency Range (IF)	GHz	DC	-	3.5
Conversion Gain RF = 34 GHz, LO = 32 GHz	dB	11.0	13.5	-
Noise Figure RF = 34 GHz, LO = 32 GHz	dB	-	3	4.5
LO Input Power	dBm	-	4	-
Input Third Order Intercept	dBm	-	-2	-
Image Rejection	dBc	-	20	-
LO/RF Isolation	dB	-	-30	-
RF Input Return Loss	dB	-	10	-
LO Input Return Loss	dB	-	10	-
IF Return Loss	dB	-	12	-
Supply Current ( $I_{D1} + I_{D2} + I_{D3}$ )	mA	-	105	-

5. Apply gate voltages prior to drain voltages. Adjust  $V_{G1}$ ,  $V_{G2}$ ,  $V_{G3}$  between -1.0 and -0.1 V to achieve specific drain current. Typical drain current: 105 mA = 10 mA ( $I_{D1}$ ) + 30 mA ( $I_{D2}$ ) + 65 mA ( $I_{D3}$ ). Refer to App Note [1] for biasing details.

## Absolute Maximum Ratings<sup>6,7,8</sup>

Parameter	Absolute Max.
Drain Voltage ( $V_{D1,2,3}$ )	+4.3 V
Drain Current ( $I_{D1,2,3}$ )	200 mA
Gate Voltage ( $V_{G1,2,3}$ )	-1.7 to 0 V
Gate Voltage ( $V_{G4}$ )	-4 V
RF Input Power	5 dBm
LO Input Power	13 dBm
Storage Temperature	-65°C to +150°C
Operating Temperature	-55°C to +85°C
Channel Temperature	+150°C

- Exceeding any one or combination of these limits may cause permanent damage to this device.
- MACOM does not recommend sustained operation near these survivability limits.
- Operating at nominal conditions with  $T_J \leq +150^\circ\text{C}$  will ensure  $\text{MTTF} > 1 \times 10^6$  hours.

## App Note [1] Biasing -

As shown in the Pin Configuration table, the XR1020-QH is operated by biasing  $V_{D1,2,3}$  at 3 V with 10, 30, 65 mA respectively. Additionally, a fixed voltage bias of -3 V is required for mixer bias. It is recommended to use active bias on  $V_{G1}$ ,  $V_{G2}$ , and  $V_{G3}$  to keep the currents in  $V_{D1}$ ,  $V_{D2}$ , and  $V_{D3}$  constant in order to maintain the best performance over temperature. Depending on the supply voltage available and the power dissipation constraints, the bias circuit may be a single transistor or a low power operational amplifier, with a low value resistor in series with the drain supply used to sense the current. The gate of the pHEMT is controlled to maintain correct drain current and thus drain voltage. The typical gate voltage needed to do this is -0.4 V. Make sure to sequence the applied voltage to ensure negative gate bias is available before applying the positive drain supply.

## App Note [2] Board Layout -

It is recommended to provide 100 pF decoupling capacitors as close to the bias pins as possible (see board layout), 10  $\mu\text{F}$  capacitors can be added further along the DC lines.

## Handling Procedures

Please observe the following precautions to avoid damage:

## Static Sensitivity

These electronic devices are sensitive to electrostatic discharge (ESD) and can be damaged by static electricity. Proper ESD control techniques should be used when handling these devices.

## Recommended Board Layout<sup>9,10</sup>

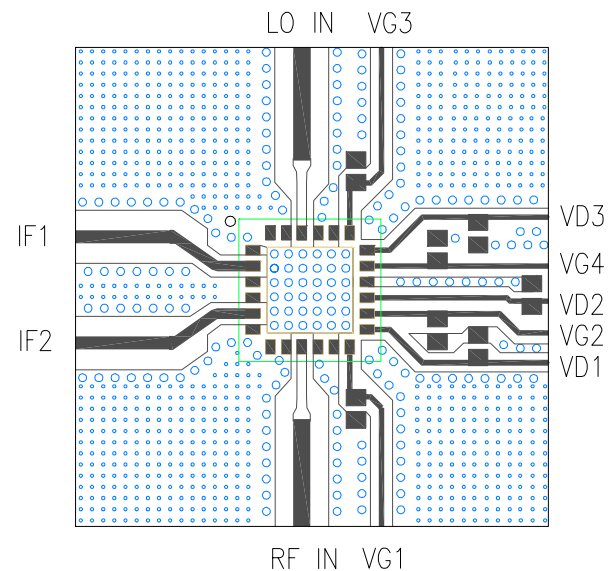

- Recommended decoupling capacitors:

100 pF, 0402

10  $\mu\text{F}$ , 0805 (optional)

- Recommend to externally ground all N/C pins.

## Typical Performance Curves

**Conversion Gain, IF = 2 GHz**

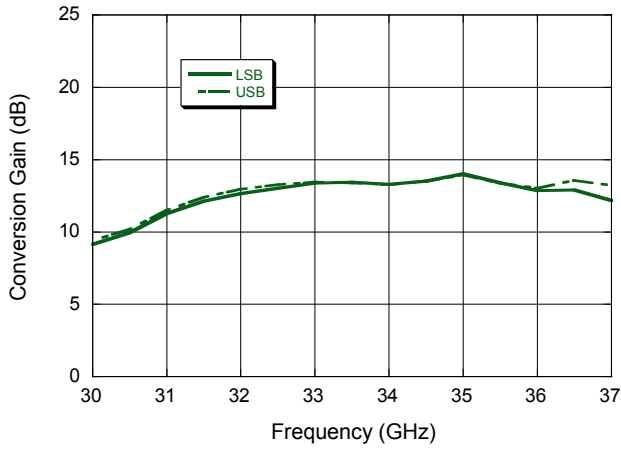

**Noise Figure, IF = 2 GHz**

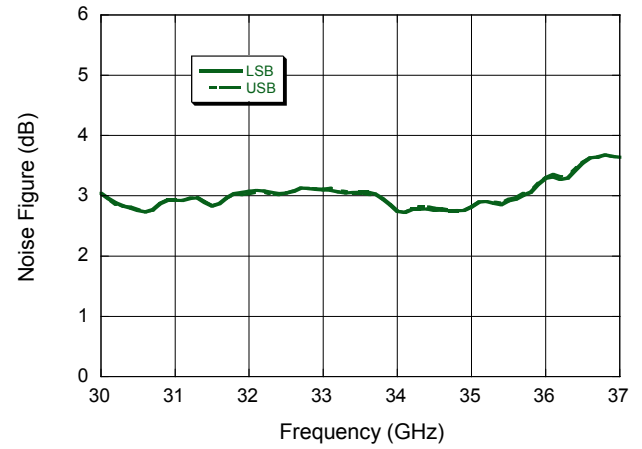

**RF-LO Rejection**

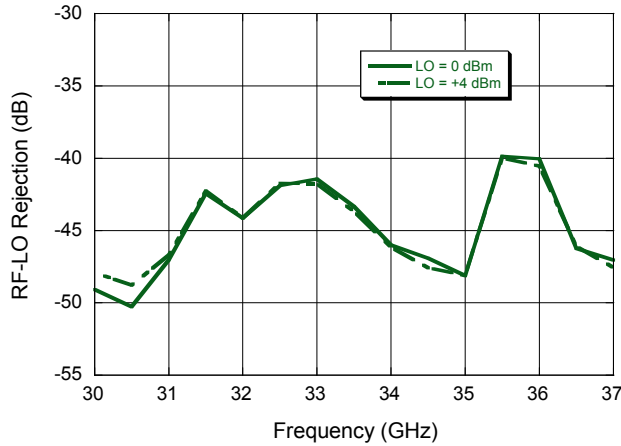

**RF and LO Return Loss**

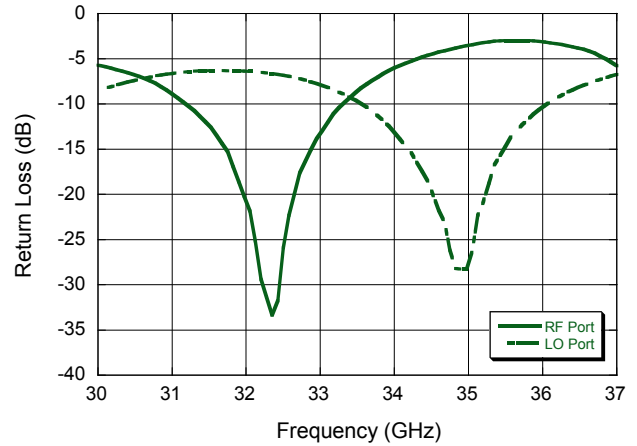

## Typical Performance Curves

**Output IP3, IF = 120 MHz**

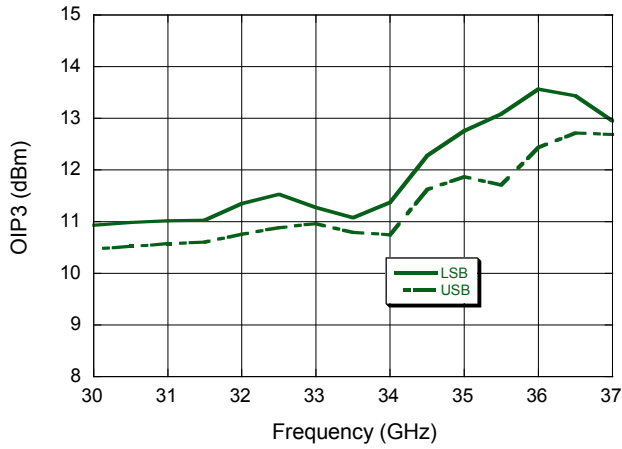

**Input IP3, IF = 120 MHz**

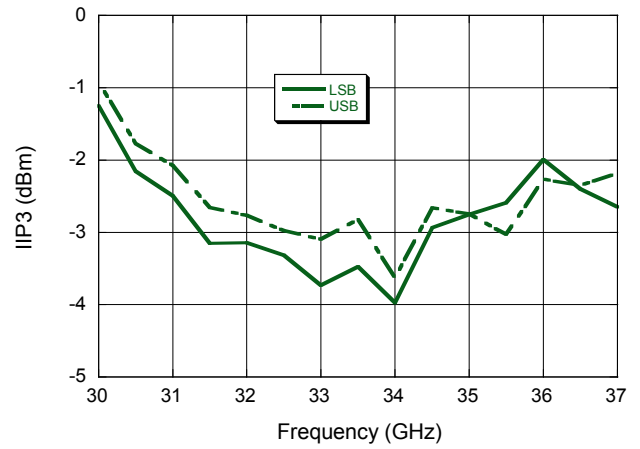

**Image Rejection, IF = 120 MHz**

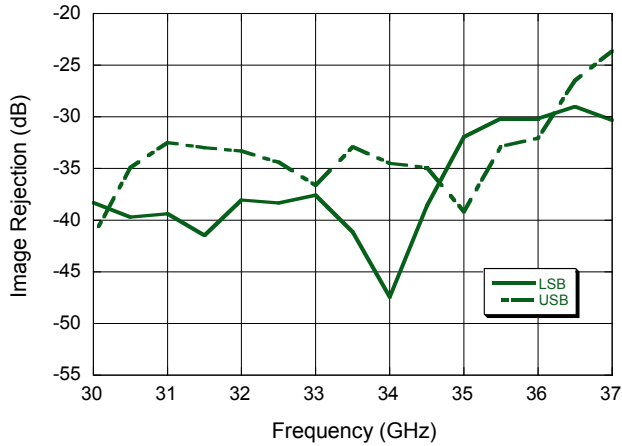

## Lead-Free Package Dimensions/Layout†

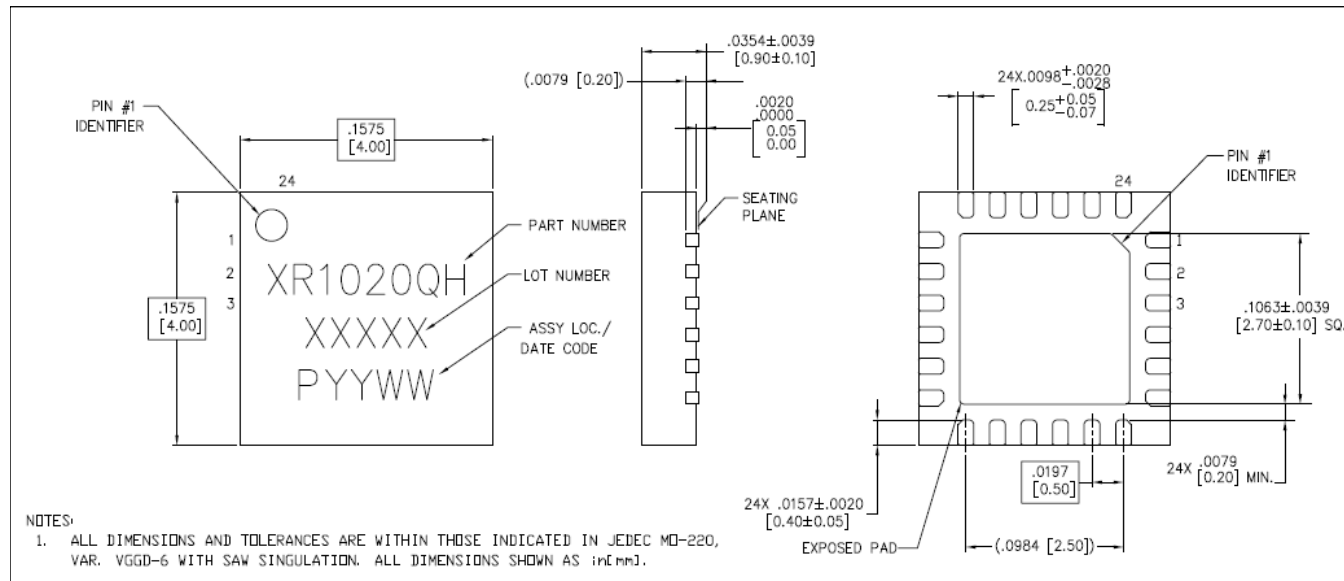

† Reference Application Note S2083 for lead-free solder reflow recommendations.  
Meets JEDEC moisture sensitivity level 3 requirements.  
Plating is 100% matte tin.

M/A-COM Technology Solutions Inc. All rights reserved.

Information in this document is provided in connection with M/A-COM Technology Solutions Inc ("MACOM") products. These materials are provided by MACOM as a service to its customers and may be used for informational purposes only. Except as provided in MACOM's Terms and Conditions of Sale for such products or in any separate agreement related to this document, MACOM assumes no liability whatsoever. MACOM assumes no responsibility for errors or omissions in these materials. MACOM may make changes to specifications and product descriptions at any time, without notice. MACOM makes no commitment to update the information and shall have no responsibility whatsoever for conflicts or incompatibilities arising from future changes to its specifications and product descriptions. No license, express or implied, by estoppel or otherwise, to any intellectual property rights is granted by this document.

THESE MATERIALS ARE PROVIDED "AS IS" WITHOUT WARRANTY OF ANY KIND, EITHER EXPRESS OR IMPLIED, RELATING TO SALE AND/OR USE OF MACOM PRODUCTS INCLUDING LIABILITY OR WARRANTIES RELATING TO FITNESS FOR A PARTICULAR PURPOSE, CONSEQUENTIAL OR INCIDENTAL DAMAGES, MERCHANTABILITY, OR INFRINGEMENT OF ANY PATENT, COPYRIGHT OR OTHER INTELLECTUAL PROPERTY RIGHT. MACOM FURTHER DOES NOT WARRANT THE ACCURACY OR COMPLETENESS OF THE INFORMATION, TEXT, GRAPHICS OR OTHER ITEMS CONTAINED WITHIN THESE MATERIALS. MACOM SHALL NOT BE LIABLE FOR ANY SPECIAL, INDIRECT, INCIDENTAL, OR CONSEQUENTIAL DAMAGES, INCLUDING WITHOUT LIMITATION, LOST REVENUES OR LOST PROFITS, WHICH MAY RESULT FROM THE USE OF THESE MATERIALS.

MACOM products are not intended for use in medical, lifesaving or life sustaining applications. MACOM customers using or selling MACOM products for use in such applications do so at their own risk and agree to fully indemnify MACOM for any damages resulting from such improper use or sale.

Компания «Океан Электроники» предлагает заключение долгосрочных отношений при поставках импортных электронных компонентов на взаимовыгодных условиях!

Наши преимущества:

- Поставка оригинальных импортных электронных компонентов напрямую с производств Америки, Европы и Азии, а так же с крупнейших складов мира;
- Широкая линейка поставок активных и пассивных импортных электронных компонентов (более 30 млн. наименований);
- Поставка сложных, дефицитных, либо снятых с производства позиций;
- Оперативные сроки поставки под заказ (от 5 рабочих дней);
- Экспресс доставка в любую точку России;
- Помощь Конструкторского Отдела и консультации квалифицированных инженеров;
- Техническая поддержка проекта, помощь в подборе аналогов, поставка прототипов;
- Поставка электронных компонентов под контролем ВП;
- Система менеджмента качества сертифицирована по Международному стандарту ISO 9001;
- При необходимости вся продукция военного и аэрокосмического назначения проходит испытания и сертификацию в лаборатории (по согласованию с заказчиком);
- Поставка специализированных компонентов военного и аэрокосмического уровня качества (Xilinx, Altera, Analog Devices, Intersil, Interpoint, Microsemi, Actel, Aeroflex, Peregrine, VPT, Syfer, Eurofarad, Texas Instruments, MS Kennedy, Miteq, Cobham, E2V, MA-COM, Hittite, Mini-Circuits, General Dynamics и др.);

Компания «Океан Электроники» является официальным дистрибьютором и эксклюзивным представителем в России одного из крупнейших производителей разъемов военного и аэрокосмического назначения «JONHON», а так же официальным дистрибьютором и эксклюзивным представителем в России производителя высокотехнологичных и надежных решений для передачи СВЧ сигналов «FORSTAR».



## JONHON

«JONHON» (основан в 1970 г.)

Разъемы специального, военного и аэрокосмического назначения:

(Применяются в военной, авиационной, аэрокосмической, морской, железнодорожной, горно- и нефтедобывающей отраслях промышленности)

«FORSTAR» (основан в 1998 г.)

ВЧ соединители, коаксиальные кабели, кабельные сборки и микроволновые компоненты:

(Применяются в телекоммуникациях гражданского и специального назначения, в средствах связи, РЛС, а так же военной, авиационной и аэрокосмической отраслях промышленности).



Телефон: 8 (812) 309-75-97 (многоканальный)

Факс: 8 (812) 320-03-32

Электронная почта: [ocean@oceanchips.ru](mailto:ocean@oceanchips.ru)

Web: <http://oceanchips.ru/>

Адрес: 198099, г. Санкт-Петербург, ул. Калинина, д. 2, корп. 4, лит. А