

## 2-line Transil™ ultralow capacitance protection for high speed USB

Datasheet – production data

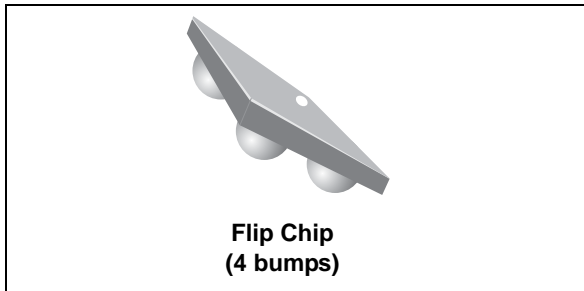

### Description

The USBULC6-2F7 is a monolithic, application specific discrete device dedicated to ESD protection of high speed interfaces.

Its ultra low line capacitance secures a high level of signal integrity without compromising the protection of downstream sensitive chips against the most stringently characterized ESD strikes.

### Features

- Ultralow capacitance (1pF)
- Two data lines (D+ and D-) protected against ESD
- Breakdown voltage  $V_{BR} = 5.5 \text{ V min.}$
- Flip Chip 350  $\mu\text{m}$  pitch, lead-free
- Very low leakage current
- Very small PCB area
- RoHS compliant

### Benefits

- Minimized impact on rise and fall times for maximum data integrity
- Low PCB space occupation
- Higher reliability offered by monolithic integration

### Complies with the following standards

- IEC 61000-4-2 level 4:
  - $\pm 8 \text{ kV}$  (contact discharge)
- MIL STD 883G - Method 3015.7
  - $\pm 25 \text{ kV}$  (Human body model)

### Application

This device is designed to protect a high speed USB port in wireless handsets (up to 480 Mb/s according to USB 2.0 high speed specification).

**Figure 1. Pin layout (bump side)**

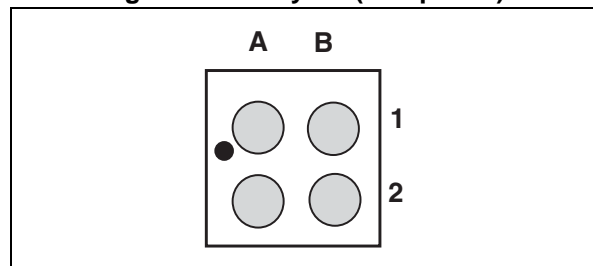

**Figure 2. Device configuration**

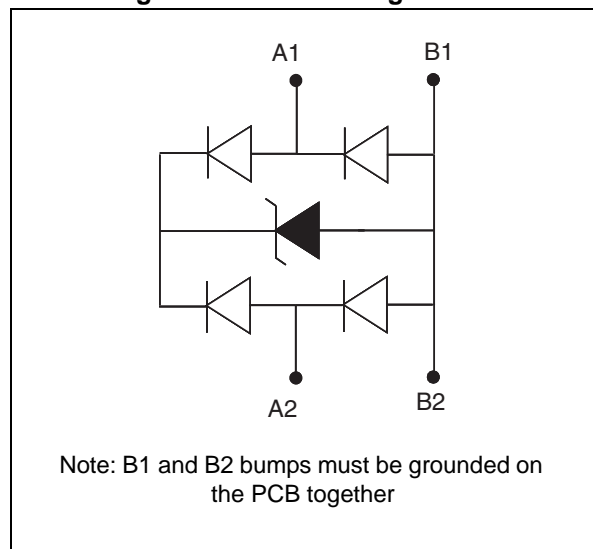

TM: Transil is a trademark of STMicroelectronics

# 1 Characteristics

**Table 1. Absolute maximum ratings ( $T_{amb} = 25\text{ }^{\circ}\text{C}$ )**

Symbol	Parameter	Value	Unit
$V_{PP}$	ESD discharge IEC 61000-4-2:		
	Contact discharge	10	kV
	Air discharge	30	
$P_{PP}$	Peak pulse power dissipation (8/20 $\mu\text{s}$ )	50	W
$T_j$	Operation junction temperature range	-40 to +150	$^{\circ}\text{C}$
$T_{stg}$	Storage temperature range	-55 to +150	$^{\circ}\text{C}$
$T_L^{(1)}$	Maximum lead temperature for soldering during 10 s	260	$^{\circ}\text{C}$

1. For a surge greater than the maximum values, the diode will fail in short-circuit.

**Figure 3. Electrical characteristics - definitions**

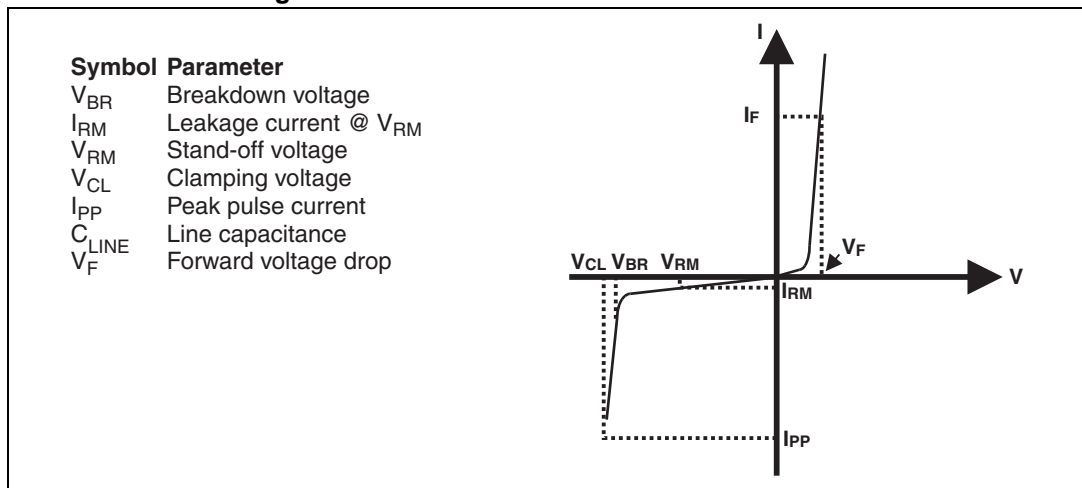

**Table 2. Electrical characteristics - values ( $T_{amb} = 25\text{ }^{\circ}\text{C}$ )**

Symbol	Test conditions	Min.	Typ.	Max.	Unit
$V_{BR}$	$I_R = 1\text{ mA}$	5.5	-	9	V
$I_{RM}$	$V_{RM} = 3\text{ V}$	-	-	70	nA
$C_{line}$	$F = [200\text{ MHz} - 3000\text{MHz}]$ , $V_R = 0\text{ V}$	-	1.0	1.35	pF
$R_d$	Dynamic resistance, pulse width 100 ns	I/O to GND	0.67		$\Omega$
		GND to I/O	0.56		

Figure 4. Eye diagram, board only (according to USB high speed specification)

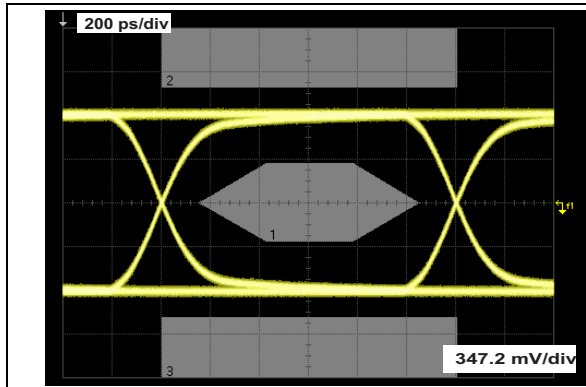

Figure 5. Eye diagram, board with USBULC6-2F7 (according to USB 2.0 high speed specification)

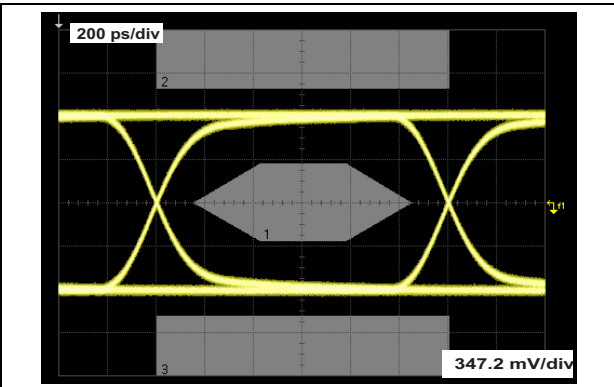

Figure 6. ESD response to IEC 61000-4-2 (+8 kV contact discharge)<sup>(1)</sup>

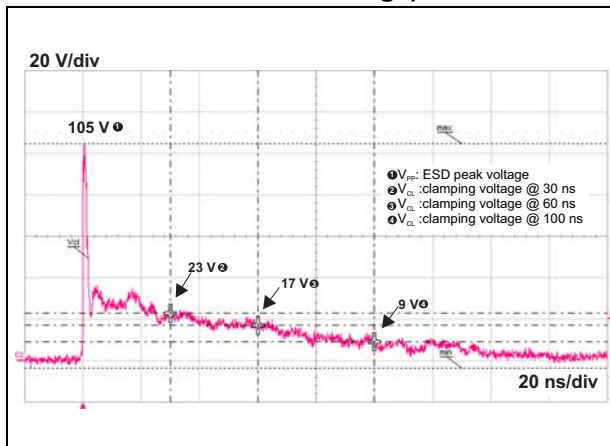
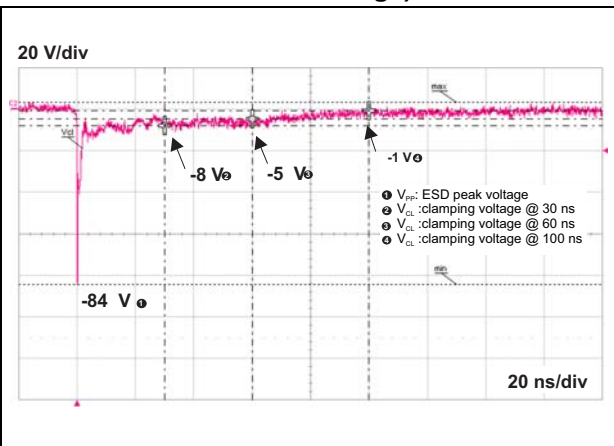

Figure 7. ESD response to IEC 61000-4-2 (-8 kV contact discharge)<sup>(1)</sup>



1. Test board connected to oscilloscope through 50 Ω cable and 20 dB + 6 dB attenuator. ESD generator return path connected to PCB ground plane.

Figure 8. Junction capacitance versus frequency (typical values)

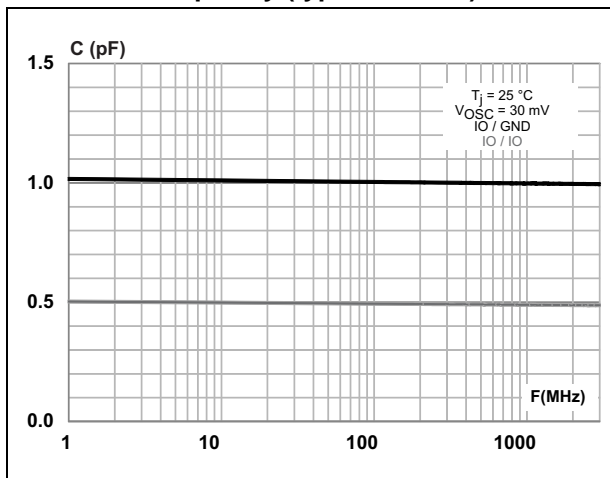

Figure 9. Analog crosstalk measurement

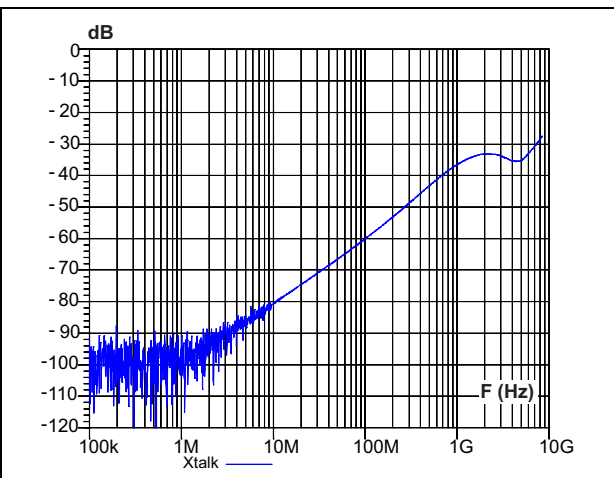

Figure 10. Peak pulse power versus initial junction temperature (maximum values)

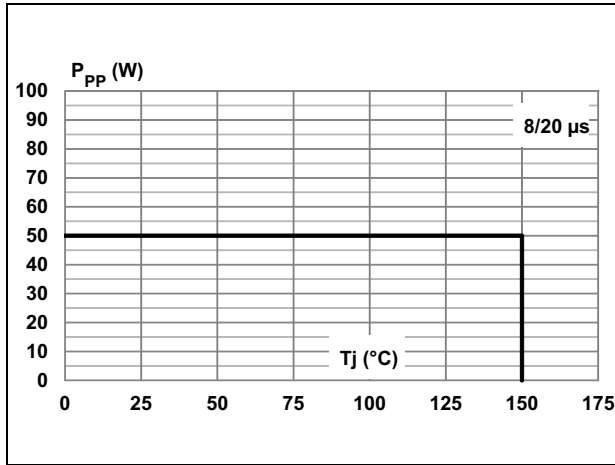

Figure 11. Peak pulse power versus exponential pulse duration (maximum values)

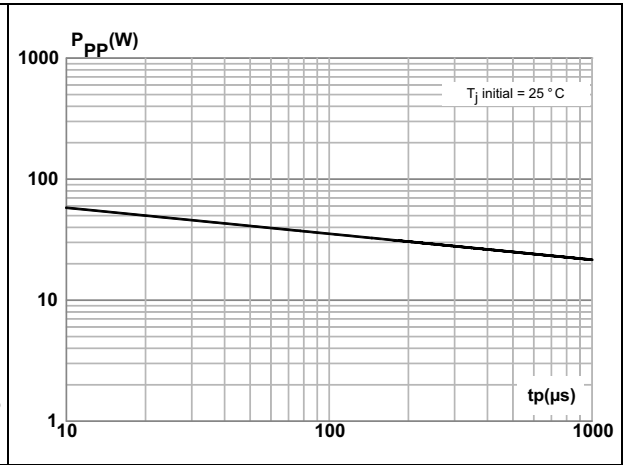

Figure 12. Clamping voltage versus peak pulse current (typical values)

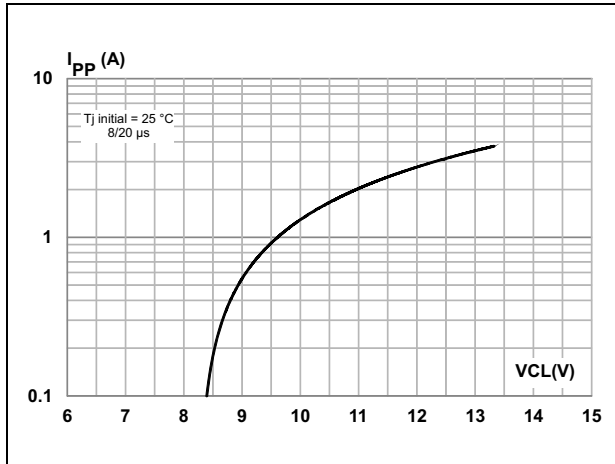

Figure 13. Leakage current versus junction temperature (typical values)

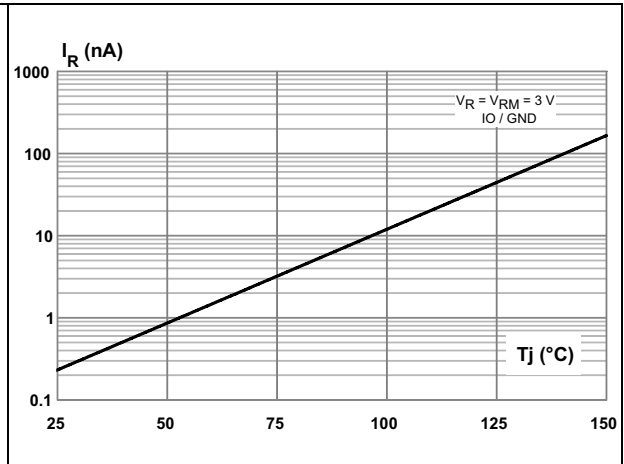

Figure 14. S21 (dB) attenuation measurement

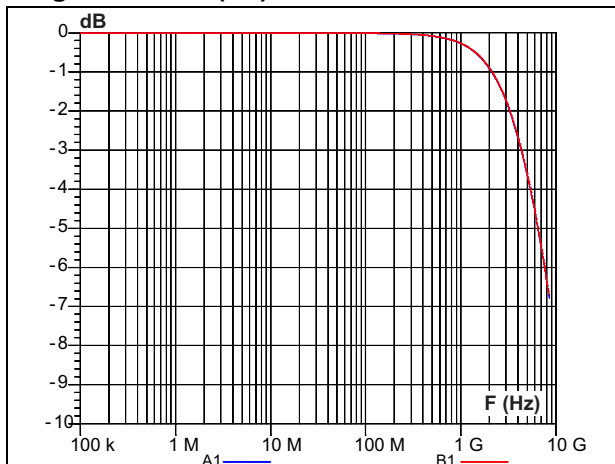
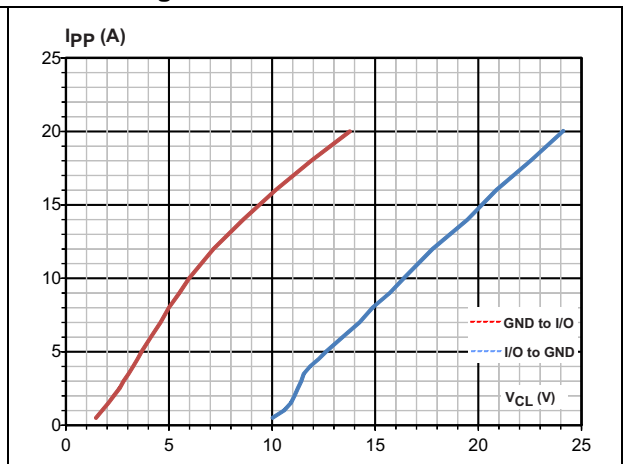
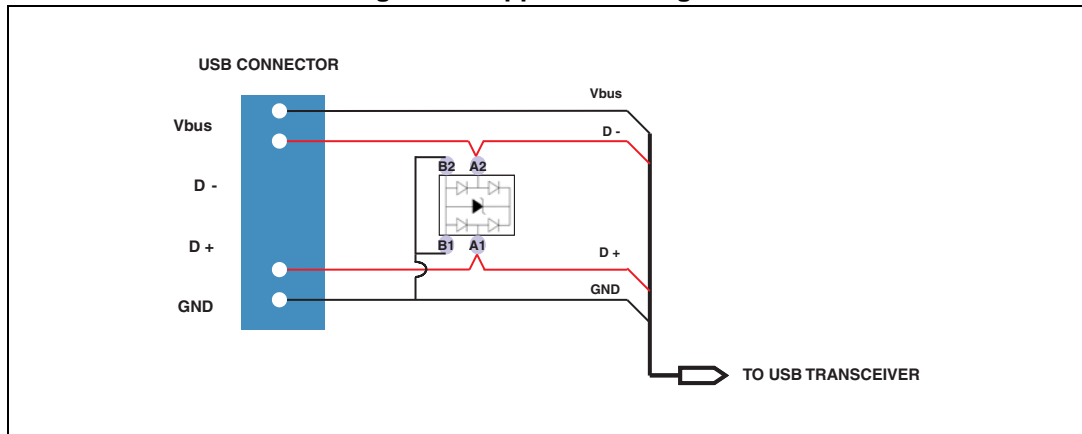

Figure 15. TLP measurement



## 2 Application information

Figure 16. Application diagram



### 3 Package information

In order to meet environmental requirements, ST offers these devices in different grades of ECOPACK® packages, depending on their level of environmental compliance. ECOPACK® specifications, grade definitions and product status are available at: [www.st.com](http://www.st.com). ECOPACK® is an ST trademark.

Figure 17. Package dimensions

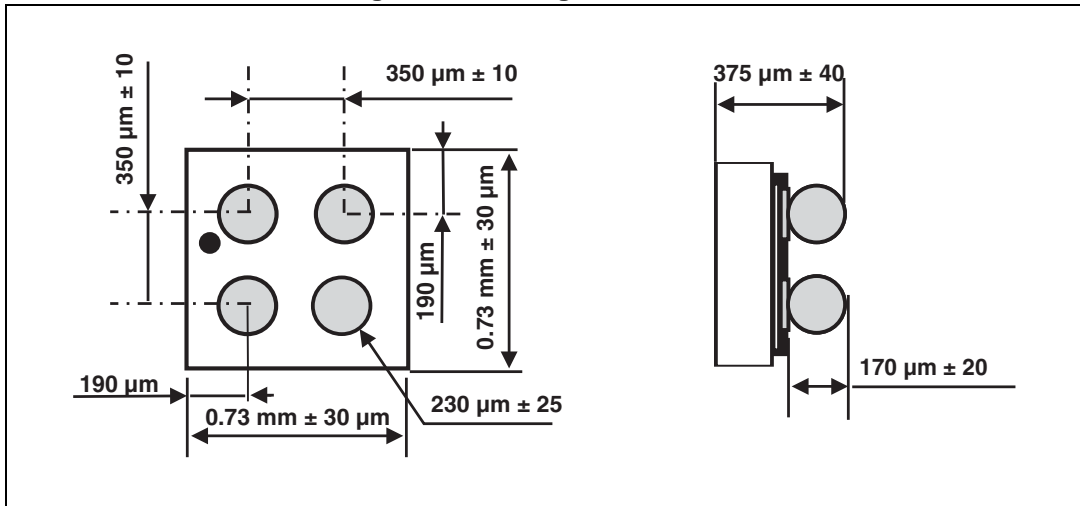

Figure 18. Footprint recommendations

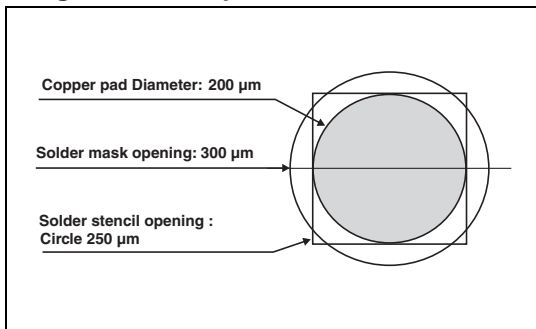

Figure 19. Marking

Dot  
 xx = marking  
 z = additional information  
 yww = datecode  
 (y = year  
 ww = week)

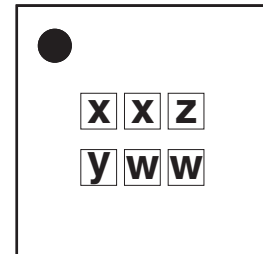
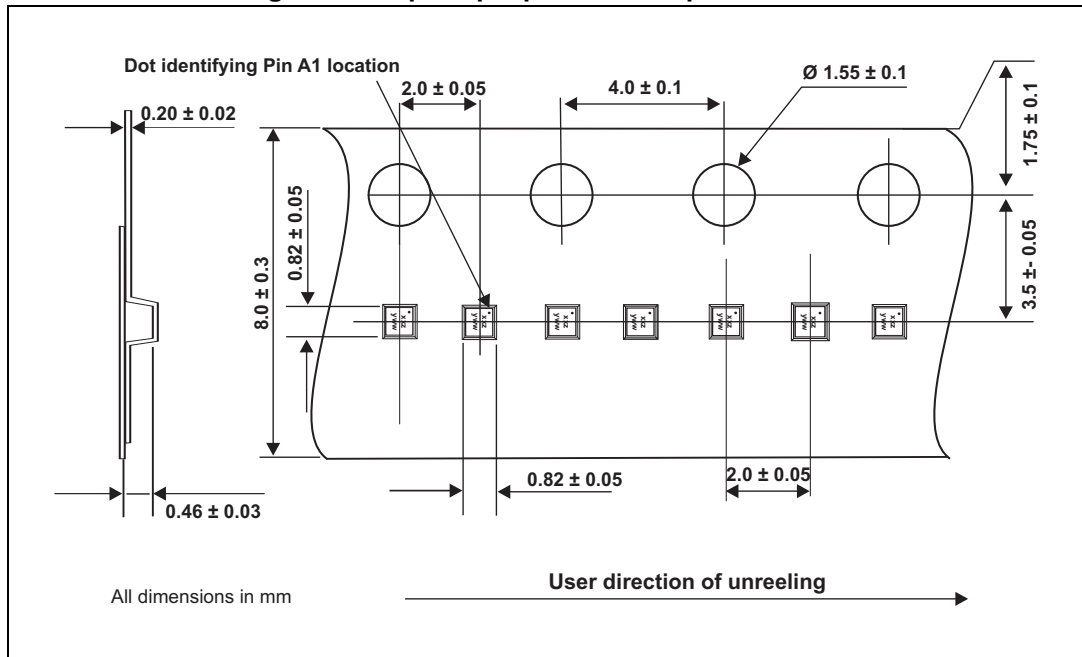

Figure 20. Flip-Chip tape and reel specifications



Note: More information is available in the STMicroelectronics Application notes:  
 AN4137: "350 µm Flip Chip: Package description and recommendations for use"  
 AN1826: "Transient protection solutions: Transil™ diode versus varistor"

## 4 Ordering information

Figure 21. Ordering information scheme

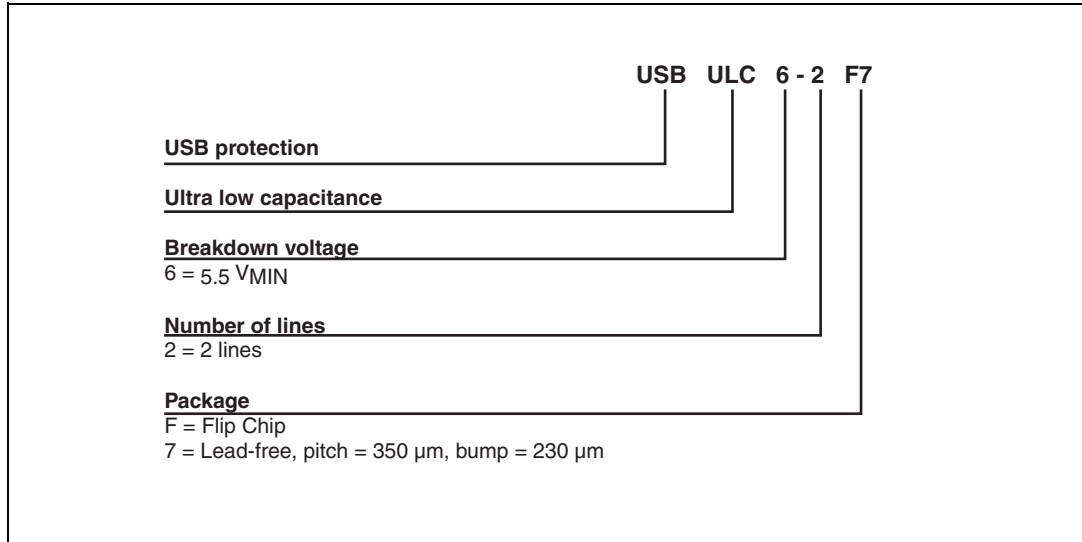

Table 3. Ordering information

Order code	Marking	Package	Weight	Base qty	Delivery mode
USBULC6-2F7	FA	Flip Chip	0.417 mg	14000	Tape and reel (7")

## 5 Revision history

Table 4. Document revision history

Date	Revision	Changes
20-Dec-2013	1	Initial release.



**Please Read Carefully:**

Information in this document is provided solely in connection with ST products. STMicroelectronics NV and its subsidiaries ("ST") reserve the right to make changes, corrections, modifications or improvements, to this document, and the products and services described herein at any time, without notice.

All ST products are sold pursuant to ST's terms and conditions of sale.

Purchasers are solely responsible for the choice, selection and use of the ST products and services described herein, and ST assumes no liability whatsoever relating to the choice, selection or use of the ST products and services described herein.

No license, express or implied, by estoppel or otherwise, to any intellectual property rights is granted under this document. If any part of this document refers to any third party products or services it shall not be deemed a license grant by ST for the use of such third party products or services, or any intellectual property contained therein or considered as a warranty covering the use in any manner whatsoever of such third party products or services or any intellectual property contained therein.

**UNLESS OTHERWISE SET FORTH IN ST'S TERMS AND CONDITIONS OF SALE ST DISCLAIMS ANY EXPRESS OR IMPLIED WARRANTY WITH RESPECT TO THE USE AND/OR SALE OF ST PRODUCTS INCLUDING WITHOUT LIMITATION IMPLIED WARRANTIES OF MERCHANTABILITY, FITNESS FOR A PARTICULAR PURPOSE (AND THEIR EQUIVALENTS UNDER THE LAWS OF ANY JURISDICTION), OR INFRINGEMENT OF ANY PATENT, COPYRIGHT OR OTHER INTELLECTUAL PROPERTY RIGHT.**

**ST PRODUCTS ARE NOT DESIGNED OR AUTHORIZED FOR USE IN: (A) SAFETY CRITICAL APPLICATIONS SUCH AS LIFE SUPPORTING, ACTIVE IMPLANTED DEVICES OR SYSTEMS WITH PRODUCT FUNCTIONAL SAFETY REQUIREMENTS; (B) AERONAUTIC APPLICATIONS; (C) AUTOMOTIVE APPLICATIONS OR ENVIRONMENTS, AND/OR (D) AEROSPACE APPLICATIONS OR ENVIRONMENTS. WHERE ST PRODUCTS ARE NOT DESIGNED FOR SUCH USE, THE PURCHASER SHALL USE PRODUCTS AT PURCHASER'S SOLE RISK, EVEN IF ST HAS BEEN INFORMED IN WRITING OF SUCH USAGE, UNLESS A PRODUCT IS EXPRESSLY DESIGNATED BY ST AS BEING INTENDED FOR "AUTOMOTIVE, AUTOMOTIVE SAFETY OR MEDICAL" INDUSTRY DOMAINS ACCORDING TO ST PRODUCT DESIGN SPECIFICATIONS. PRODUCTS FORMALLY ESCC, QML OR JAN QUALIFIED ARE DEEMED SUITABLE FOR USE IN AEROSPACE BY THE CORRESPONDING GOVERNMENTAL AGENCY.**

Resale of ST products with provisions different from the statements and/or technical features set forth in this document shall immediately void any warranty granted by ST for the ST product or service described herein and shall not create or extend in any manner whatsoever, any liability of ST.

ST and the ST logo are trademarks or registered trademarks of ST in various countries.

Information in this document supersedes and replaces all information previously supplied.

The ST logo is a registered trademark of STMicroelectronics. All other names are the property of their respective owners.

© 2013 STMicroelectronics - All rights reserved

STMicroelectronics group of companies

Australia - Belgium - Brazil - Canada - China - Czech Republic - Finland - France - Germany - Hong Kong - India - Israel - Italy - Japan - Malaysia - Malta - Morocco - Philippines - Singapore - Spain - Sweden - Switzerland - United Kingdom - United States of America

[www.st.com](http://www.st.com)



Компания «Океан Электроники» предлагает заключение долгосрочных отношений при поставках импортных электронных компонентов на взаимовыгодных условиях!

Наши преимущества:

- Поставка оригинальных импортных электронных компонентов напрямую с производств Америки, Европы и Азии, а так же с крупнейших складов мира;
- Широкая линейка поставок активных и пассивных импортных электронных компонентов (более 30 млн. наименований);
- Поставка сложных, дефицитных, либо снятых с производства позиций;
- Оперативные сроки поставки под заказ (от 5 рабочих дней);
- Экспресс доставка в любую точку России;
- Помощь Конструкторского Отдела и консультации квалифицированных инженеров;
- Техническая поддержка проекта, помощь в подборе аналогов, поставка прототипов;
- Поставка электронных компонентов под контролем ВП;
- Система менеджмента качества сертифицирована по Международному стандарту ISO 9001;
- При необходимости вся продукция военного и аэрокосмического назначения проходит испытания и сертификацию в лаборатории (по согласованию с заказчиком);
- Поставка специализированных компонентов военного и аэрокосмического уровня качества (Xilinx, Altera, Analog Devices, Intersil, Interpoint, Microsemi, Actel, Aeroflex, Peregrine, VPT, Syfer, Eurofarad, Texas Instruments, MS Kennedy, Miteq, Cobham, E2V, MA-COM, Hittite, Mini-Circuits, General Dynamics и др.);

Компания «Океан Электроники» является официальным дистрибьютором и эксклюзивным представителем в России одного из крупнейших производителей разъемов военного и аэрокосмического назначения «JONHON», а так же официальным дистрибьютором и эксклюзивным представителем в России производителя высокотехнологичных и надежных решений для передачи СВЧ сигналов «FORSTAR».



## JONHON

«JONHON» (основан в 1970 г.)

Разъемы специального, военного и аэрокосмического назначения:

(Применяются в военной, авиационной, аэрокосмической, морской, железнодорожной, горно- и нефтедобывающей отраслях промышленности)

«FORSTAR» (основан в 1998 г.)

ВЧ соединители, коаксиальные кабели,  
кабельные сборки и микроволновые компоненты:

(Применяются в телекоммуникациях гражданского и специального назначения, в средствах связи, РЛС, а так же военной, авиационной и аэрокосмической отраслях промышленности).



Телефон: 8 (812) 309-75-97 (многоканальный)

Факс: 8 (812) 320-03-32

Электронная почта: [ocean@oceanchips.ru](mailto:ocean@oceanchips.ru)

Web: <http://oceanchips.ru/>

Адрес: 198099, г. Санкт-Петербург, ул. Калинина, д. 2, корп. 4, лит. А