

# Slotted Optical Switch

## OPB830 and OPB840 (L and W)



### Features:

- 0.125" (3.18 mm) wide slot
- Choice of electrical output parameters
- Choice of aperture
- Choice of opaque or IR transmissive shell material
- Side mount configuration
- Choice of lead spacing (L Series)
- 24" [610 mm] 26 AWG wire leads (W Series)



### Description:

OPB830 and OPB840 series provide the design engineer with the flexibility of a custom device from a standard product line. The L Series offers a choice of PCBoard mount lead spacing, while the W Series offers 24" (610mm) 26AWG wire leads.

Building from a standard housing that utilizes a .375" (9.5 mm) wide slot, a user can specify the electrical output parameters, choice of aperture, discrete shell material, side mount configuration, and a choice of lead spacing (for the L Series) or 24" [610 mm] UL approved 26 AWG wire leads (W Series).

Housings are made from an opaque grade of injection-molded plastic that minimizes the assembly's sensitivity to visible and near-infrared ambient radiation. Discrete shells (exposed on the parallel faces inside the device throat) are made of either IR transmissive plastic (for applications where aperture contamination may occur) or of opaque plastic with aperture openings (for maximum protection against ambient light).

Switching of the phototransistor occurs whenever an opaque object passes through the slot and interrupts the beam.

### Applications:

- Non-contact interruptive object sensing
- Assembly line automation
- Machine automation
- Equipment security
- Machine safety

#### General Note

TT Electronics reserves the right to make changes in product specification without notice or liability. All information is subject to TT Electronics' own data and is considered accurate at time of going to print.

TT Electronics | Optek Technology, Inc.  
1645 Wallace Drive, Ste. 130, Carrollton, TX USA 75006 | Ph: +1 972 323 2200  
www.ttelectronics.com | sensors@ttelectronics.com

# Slotted Optical Switch

## OPB830 and OPB840 (L and W)



### Electrical Specifications

#### Absolute Maximum Ratings ( $T_A=25^\circ\text{C}$ unless otherwise noted)

Storage and Operating Temperature L Series <sup>(1)</sup> W Series <sup>(1)</sup>	-40° C to +85° C -40° C to +80° C
Lead Soldering Temperature [1/16 inch (1.6mm) from the case for 5 sec. with soldering iron] <sup>(2)</sup>	260° C

#### Input Diode

Forward DC Current	50 mA
Peak Forward Current (1 $\mu\text{s}$ pulse width, 300 pps)	1 A
Reverse DC Voltage	2 V
Power Dissipation <sup>(1)</sup>	100 mW

#### Output Phototransistor

Collector-Emitter Voltage	30 V
Emitter-Collector Voltage	5 V
Collector DC Current	30 mA
Power Dissipation <sup>(1)</sup>	100 mW

#### Electrical Characteristics ( $T_A = 25^\circ\text{C}$ unless otherwise noted)

SYMBOL	PARAMETER	MIN	TYP	MAX	UNITS	TEST CONDITIONS
--------	-----------	-----	-----	-----	-------	-----------------

#### Input Diode LED (See OP240 for additional information—for reference only)

$V_F$	Forward Voltage	-	-	1.7	V	$I_F = 20\text{ mA}$
$I_R$	Reverse Current	-	-	100	$\mu\text{A}$	$V_R = 2\text{ V}$

#### Output Transistor (See OP550 for additional information—for reference only)

$V_{(BR)CEO}$	Collector-Emitter Breakdown Voltage	30	-	-	V	$I_C = 1\text{ mA}$
$V_{(BR)ECO}$	Emitter-Collector Breakdown Voltage	5	-	-	V	$I_E = 100\ \mu\text{A}$
$I_{CEO}$	Collector-Emitter Dark Current	-	-	100	nA	$V_{CE} = 10\text{ V}$

#### Notes:

- (1) Derate linearly 1.67 mW/° C above 25° C for L Series.
- (2) RMA flux is recommended. Duration can be extended to 10 seconds maximum when flow soldering.
- (3) Methanol or isopropanol are recommended as cleaning agents. Plastic housing is soluble in chlorinated hydrocarbons and ketones.
- (4) The W Series includes wire terminations of 24" (610 mm) 7-strand, 26 AWG UL insulated wire on each terminal. Each device incorporates a wire strain relief at the housing surface. The insulation functions and colors are: anode (red), cathode (black), phototransistor collector (white) and phototransistor emitter (green).
- (5) All parameters tested using pulse technique.

#### General Note

TT Electronics reserves the right to make changes in product specification without notice or liability. All information is subject to TT Electronics' own data and is considered accurate at time of going to print.

TT Electronics | Optek Technology, Inc.  
1645 Wallace Drive, Ste. 130, Carrollton, TX USA 75006 | Ph: +1 972 323 2200  
www.ttelectronics.com | sensors@ttelectronics.com

# Slotted Optical Switch

## OPB830 and OPB840 (L and W)



### Electrical Characteristics ( $T_A = 25^\circ\text{C}$ unless otherwise noted)

SYMBOL	PARAMETER	MIN	TYP	MAX	UNITS	TEST CONDITIONS
<b>Combined</b>						
$V_{CE(SAT)}$	Collector-Emitter Saturation Voltage Parameter A (OPB830L,OPB840L) (OPB835L, OPB845L) (OPB830W,OPB840W) (OPB835W, OPB845W)	-	-	0.4	V	$I_C = 400 \mu\text{A}, I_F = 20 \text{ mA}$
	Parameter B (OPB831L,OPB841L) (OPB836L,OPB846L) (OPB831W,OPB841W) (OPB836W,OPB846W)	-	-	0.4	V	$I_C = 800 \mu\text{A}, I_F = 10 \text{ mA}$
	Parameter C (OPB832L,OPB842L) (OPB837L,OPB847L) (OPB832W,OPB842W) (OPB837W,OPB847W)	-	-	0.6	V	$I_C = 1800 \mu\text{A}, I_F = 20 \text{ mA}$
$I_{C(ON)}$	On-State Collector Current Parameter A (OPB830L,OPB840L) (OPB835L, OPB845L) (OPB830W,OPB840W) (OPB835W, OPB845W)	0.625	-	-	mA	$V_{CE} = 10 \text{ V}, I_F = 20 \text{ mA}$
	Parameter B (OPB831L,OPB841L) (OPB836L,OPB846L) (OPB831W,OPB841W) (OPB836W,OPB846W)	1.250	-	-	mA	$V_{CE} = 5 \text{ V}, I_F = 10 \text{ mA}$
	Parameter C (OPB832L,OPB842L) (OPB837L,OPB847L) (OPB832W,OPB842W) (OPB837W,OPB847W)	2.250	-	-	mA	$V_{CE} = .6 \text{ V}, I_F = 20 \text{ mA}$

#### General Note

TT Electronics reserves the right to make changes in product specification without notice or liability. All information is subject to TT Electronics' own data and is considered accurate at time of going to print.

TT Electronics | Optek Technology, Inc.  
1645 Wallace Drive, Ste. 130, Carrollton, TX USA 75006 | Ph: +1 972 323 2200  
www.ttelectronics.com | sensors@ttelectronics.com

# Slotted Optical Switch

## OPB830 and OPB840 (L and W)



OPB8\_\_ L11 - Flag Next to Emitter



OPB8\_\_ L11 - Flag Next to Sensor

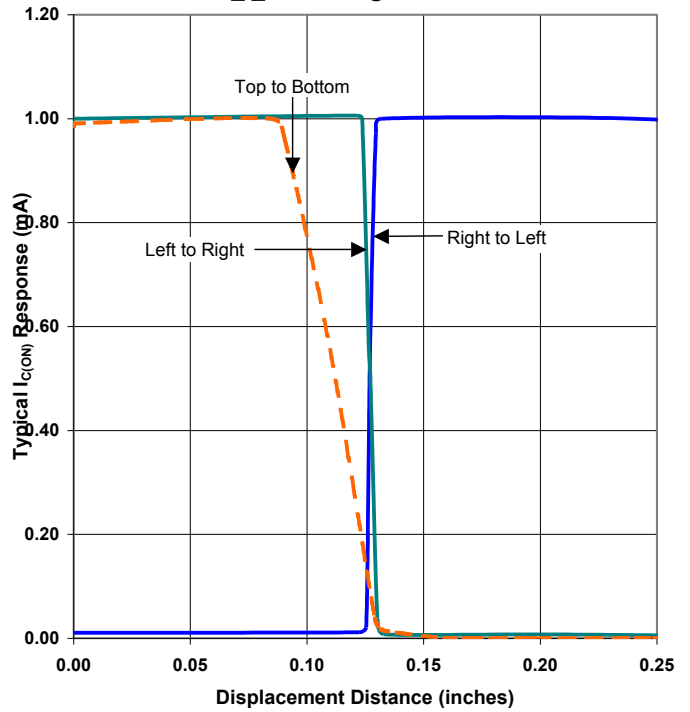

OPB8\_\_ L11 - Flag in Middle of Slot



General Note  
 TT Electronics reserves the right to make changes in product specification without notice or liability. All information is subject to TT Electronics' own data and is considered accurate at time of going to print.

TT Electronics | Optek Technology, Inc.  
 1645 Wallace Drive, Ste. 130, Carrollton, TX USA 75006 | Ph: +1 972 323 2200  
[www.ttelectronics.com](http://www.ttelectronics.com) | [sensors@ttelectronics.com](mailto:sensors@ttelectronics.com)

# Slotted Optical Switch

## OPB830 and OPB840 (L and W)



OPB8\_\_ L51 - Flag Next to Emitter



OPB8\_\_ L51 - Flag Next to Sensor



OPB8\_\_ L51 - Flag in Middle of Slot

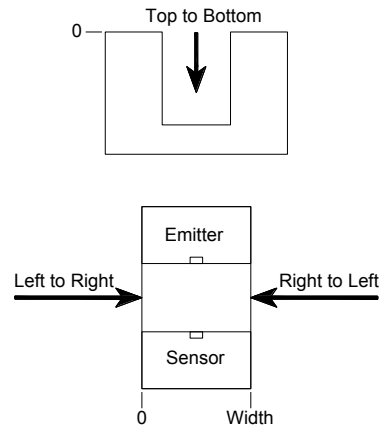

General Note  
 TT Electronics reserves the right to make changes in product specification without notice or liability. All information is subject to TT Electronics' own data and is considered accurate at time of going to print.

TT Electronics | Optek Technology, Inc.  
 1645 Wallace Drive, Ste. 130, Carrollton, TX USA 75006 | Ph: +1 972 323 2200  
[www.ttelectronics.com](http://www.ttelectronics.com) | [sensors@ttelectronics.com](mailto:sensors@ttelectronics.com)

# Slotted Optical Switch

## OPB830 and OPB840 (L and W)



OPB8\_\_ L55 - Flag Next to Emitter

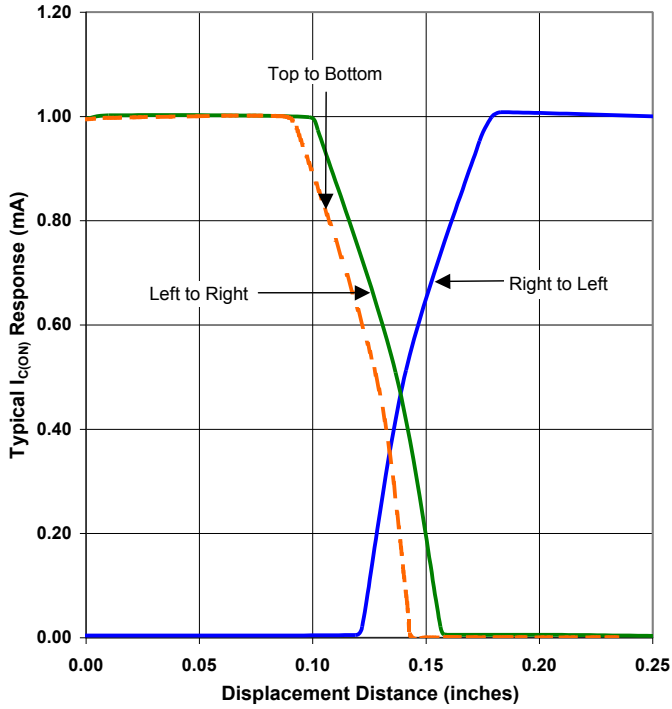

OPB8\_\_ L55 - Flag Next to Sensor

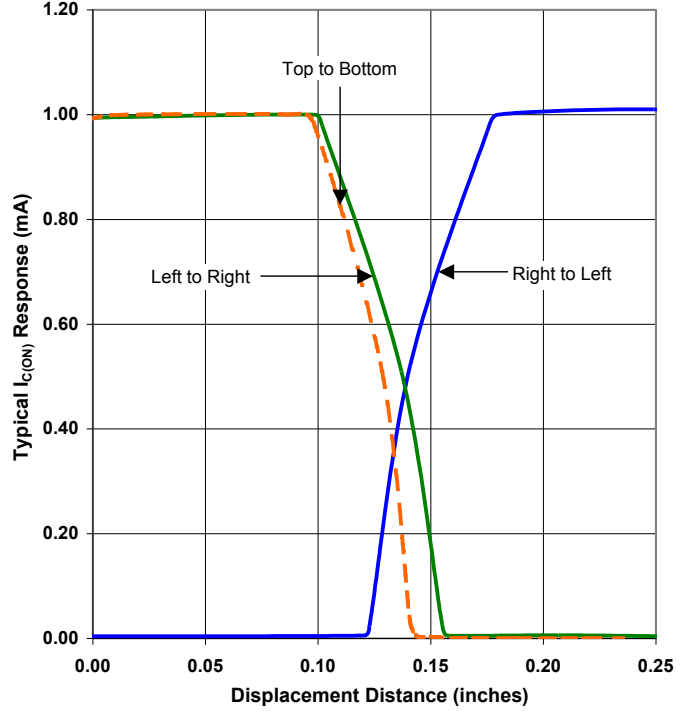

OPB8\_\_ L55 - Flag in Middle of Slot

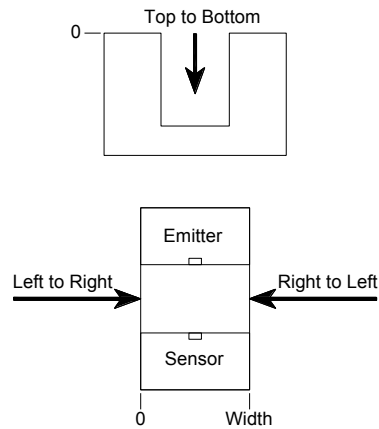
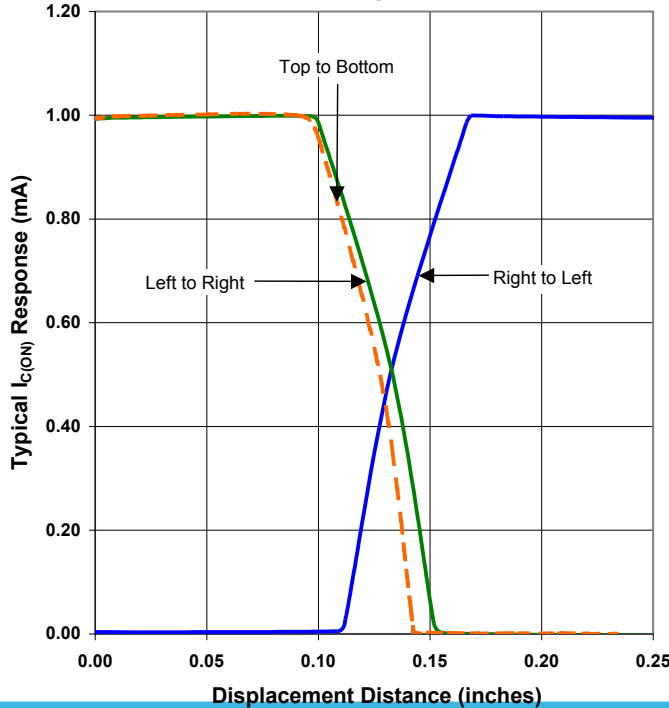

General Note

TT Electronics reserves the right to make changes in product specification without notice or liability. All information is subject to TT Electronics' own data and is considered accurate at time of going to print.

TT Electronics | Optek Technology, Inc.  
1645 Wallace Drive, Ste. 130, Carrollton, TX USA 75006 | Ph: +1 972 323 2200  
www.ttelectronics.com | sensors@ttelectronics.com

# Slotted Optical Switch

## OPB830 and OPB840 (L and W)



### Packaging

#### OPB830/840L Series



DIMENSIONS ARE IN INCHES AND [MILLIMETERS].

#### OPB830/840W Series

Pin # / Color	Description
1 / Black	Cathode
2 / Red	Anode
3 / White	Collector
4 / Green	Emitter

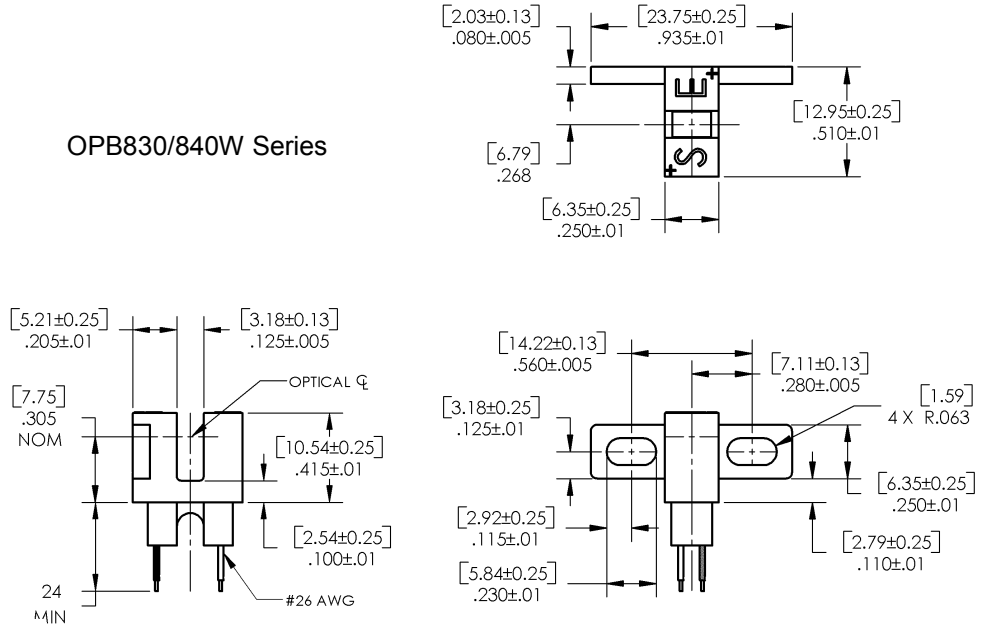

DIMENSIONS ARE IN INCHES AND [MILLIMETERS].

DIMENSIONS ARE IN: [ MILLIMETERS]  
INCHES

General Note  
TT Electronics reserves the right to make changes in product specification without notice or liability. All information is subject to TT Electronics' own data and is considered accurate at time of going to print.

TT Electronics | Optek Technology, Inc.  
1645 Wallace Drive, Ste. 130, Carrollton, TX USA 75006 | Ph: +1 972 323 2200  
www.ttelectronics.com | sensors@ttelectronics.com

# Slotted Optical Switch

## OPB830 and OPB840 (L and W)



### Part Number Guide — OPB8XX

**OPB 8 X X L X X**

Optek Assembly

Phototransistor Output Family

Discrete Shell Material:  
 3 — Side mount IR transmissive  
     Plastic discrete shell  
 4 — Side mount opaque  
     Plastic discrete shell

Sensor Aperture:  
 1 — 0.010" (0.25 mm)  
 5 — 0.050" (1.27 mm)

Emitter Aperture:  
 1 — 0.010" (0.25 mm)  
 5 — 0.050" (1.27 mm)

Mounting configurations:  
 L — Solder lead termination

#### Electrical Specification Variations:

- 0 = Electrical Parameter A - (0.320" lead spacing)
- 1 = Electrical Parameter B - (0.320" lead spacing)
- 2 = Electrical Parameter C - (0.320" lead spacing)
- 5 = Electrical Parameter A - (0.220" lead spacing)
- 6 = Electrical Parameter B - (0.220" lead spacing)
- 7 = Electrical Parameter C - (0.220" lead spacing)

#### Notes:

- Assemblies with dual 0.010" apertures are currently available with electrical parameter "A" only.

### Part Number Guide — OPB8XX

**OPB 8 X X W X X Z**

Optek Assembly

Phototransistor Output Family

Discrete Shell Material:  
 3 — Side mount IR transmissive  
     Plastic discrete shell  
 4 — Side mount opaque  
     Plastic discrete shell

Sensor Aperture:  
 1 — 0.010" (0.25 mm)  
 5 — 0.050" (1.27 mm)

Emitter Aperture:  
 1 — 0.010" (0.25 mm)  
 5 — 0.050" (1.27 mm)

Mounting configurations:  
 W — Wire termination  
     • Parts ending with "Z" meet  
       RoHS requirements  
     • Wires = 26 AWG—24" Long

#### Electrical Specification Variations:

- 0 = Electrical Parameter A
- 1 = Electrical Parameter B
- 2 = Electrical Parameter C

#### Notes:

- Assemblies with dual 0.010" apertures are currently available with electrical parameter "A" only.

#### General Note

TT Electronics reserves the right to make changes in product specification without notice or liability. All information is subject to TT Electronics' own data and is considered accurate at time of going to print.

TT Electronics | Optek Technology, Inc.  
 1645 Wallace Drive, Ste. 130, Carrollton, TX USA 75006 | Ph: +1 972 323 2200  
[www.ttelectronics.com](http://www.ttelectronics.com) | [sensors@ttelectronics.com](mailto:sensors@ttelectronics.com)



Компания «Океан Электроники» предлагает заключение долгосрочных отношений при поставках импортных электронных компонентов на взаимовыгодных условиях!

Наши преимущества:

- Поставка оригинальных импортных электронных компонентов напрямую с производств Америки, Европы и Азии, а так же с крупнейших складов мира;
- Широкая линейка поставок активных и пассивных импортных электронных компонентов (более 30 млн. наименований);
- Поставка сложных, дефицитных, либо снятых с производства позиций;
- Оперативные сроки поставки под заказ (от 5 рабочих дней);
- Экспресс доставка в любую точку России;
- Помощь Конструкторского Отдела и консультации квалифицированных инженеров;
- Техническая поддержка проекта, помощь в подборе аналогов, поставка прототипов;
- Поставка электронных компонентов под контролем ВП;
- Система менеджмента качества сертифицирована по Международному стандарту ISO 9001;
- При необходимости вся продукция военного и аэрокосмического назначения проходит испытания и сертификацию в лаборатории (по согласованию с заказчиком);
- Поставка специализированных компонентов военного и аэрокосмического уровня качества (Xilinx, Altera, Analog Devices, Intersil, Interpoint, Microsemi, Actel, Aeroflex, Peregrine, VPT, Syfer, Eurofarad, Texas Instruments, MS Kennedy, Miteq, Cobham, E2V, MA-COM, Hittite, Mini-Circuits, General Dynamics и др.);

Компания «Океан Электроники» является официальным дистрибьютором и эксклюзивным представителем в России одного из крупнейших производителей разъемов военного и аэрокосмического назначения «JONHON», а так же официальным дистрибьютором и эксклюзивным представителем в России производителя высокотехнологичных и надежных решений для передачи СВЧ сигналов «FORSTAR».



## JONHON

«JONHON» (основан в 1970 г.)

Разъемы специального, военного и аэрокосмического назначения:

(Применяются в военной, авиационной, аэрокосмической, морской, железнодорожной, горно- и нефтедобывающей отраслях промышленности)

«FORSTAR» (основан в 1998 г.)

ВЧ соединители, коаксиальные кабели,  
кабельные сборки и микроволновые компоненты:

(Применяются в телекоммуникациях гражданского и специального назначения, в средствах связи, РЛС, а так же военной, авиационной и аэрокосмической отраслях промышленности).



Телефон: 8 (812) 309-75-97 (многоканальный)

Факс: 8 (812) 320-03-32

Электронная почта: [ocean@oceanchips.ru](mailto:ocean@oceanchips.ru)

Web: <http://oceanchips.ru/>

Адрес: 198099, г. Санкт-Петербург, ул. Калинина, д. 2, корп. 4, лит. А