

**RoHS Sxx08xSx & Sxx08x Series**



**Description**

Excellent unidirectional switches for phase control applications such as heating and motor speed controls. Sensitive gate SCRs are easily triggered with microAmps of current as furnished by sense coils, proximity switches, and microprocessors. Standard phase control SCRs are triggered with few milliamperes of current at less than 1.5V potential.

**Features & Benefits**

- RoHS compliant
- Glass – passivated junctions
- Voltage capability up to 1000 V
- Surge capability up to 100 A

**Applications**

Typical applications are capacitive discharge systems for strobe lights, nailers, staplers and gas engine ignition. Also controls for power tools, home/brown goods and white goods appliances. Internally constructed isolated packages are offered for ease of heat sinking with highest isolation voltage.

**Agency Approval**

Agency	Agency File Number
	L Package: E71639

**Main Features**

Symbol	Value	Unit
$I_{T(RMS)}$	8	A
$V_{DRM}/V_{RRM}$	400 to 1000	V
$I_{GT}$	0.2 to 15	mA

**Schematic Symbol**

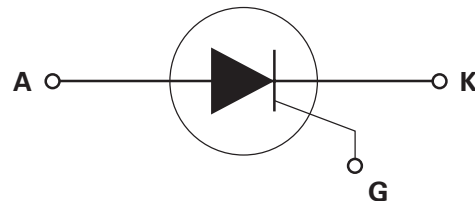

**Absolute Maximum Ratings – Sensitive SCRs**

Symbol	Parameter	Test Conditions		Value	Unit
$I_{T(RMS)}$	RMS on-state current	Sxx08LSy	$T_c = 80^\circ\text{C}$	8	A
		Sxx08RSy Sxx08DSy Sxx08VSy	$T_c = 95^\circ\text{C}$		
$I_{T(AV)}$	Average on-state current	Sxx08LSy	$T_c = 80^\circ\text{C}$	5.1	A
		Sxx08RSy Sxx08DSy Sxx08VSy	$T_c = 95^\circ\text{C}$		
$I_{TSM}$	Peak non-repetitive surge current	single half cycle; $f = 50\text{Hz}$ ; $T_J$ (initial) = $25^\circ\text{C}$		83	A
		single half cycle; $f = 60\text{Hz}$ ; $T_J$ (initial) = $25^\circ\text{C}$		100	
$I^2t$	$I^2t$ Value for fusing	$t_p = 8.3 \text{ ms}$		41	$\text{A}^2\text{s}$
$di/dt$	Critical rate of rise of on-state current	$f = 60 \text{ Hz}$ ; $T_J = 110^\circ\text{C}$		70	$\text{A}/\mu\text{s}$
$I_{GTM}$	Peak gate current	$T_J = 110^\circ\text{C}$		1.6	A
$P_{G(AV)}$	Average gate power dissipation	$T_J = 110^\circ\text{C}$		0.4	W
$T_{stg}$	Storage temperature range			-40 to 150	$^\circ\text{C}$
$T_J$	Operating junction temperature range			-40 to 110	$^\circ\text{C}$

Note: xx = voltage, y = sensitivity

**Absolute Maximum Ratings – Standard SCRs**

Symbol	Parameter	Test Conditions		Value	Unit
$I_{T(RMS)}$	RMS on-state current	Sxx08L	$T_c = 100^\circ\text{C}$	8	A
		Sxx08R Sxx08D Sxx08V	$T_c = 110^\circ\text{C}$		
$I_{T(AV)}$	Average on-state current	Sxx08L	$T_c = 100^\circ\text{C}$	5.1	A
		Sxx08R Sxx08D Sxx08V	$T_c = 110^\circ\text{C}$		
$I_{TSM}$	Peak non-repetitive surge current	single half cycle; $f = 50\text{Hz}$ ; $T_J$ (initial) = $25^\circ\text{C}$		83	A
		single half cycle; $f = 60\text{Hz}$ ; $T_J$ (initial) = $25^\circ\text{C}$		100	
$I^2t$	$I^2t$ Value for fusing	$t_p = 8.3 \text{ ms}$		41	$\text{A}^2\text{s}$
$di/dt$	Critical rate-of-rise of on-state current	$f = 60 \text{ Hz}$ ; $T_J = 125^\circ\text{C}$		100	$\text{A}/\mu\text{s}$
$I_{GM}$	Peak gate current	$T_J = 125^\circ\text{C}$		2	A
$P_{G(AV)}$	Average gate power dissipation	$T_J = 125^\circ\text{C}$		0.5	W
$T_{stg}$	Storage temperature range			-40 to 150	$^\circ\text{C}$
$T_J$	Operating junction temperature range			-40 to 125	$^\circ\text{C}$

Note: xx = voltage

**Electrical Characteristics ( $T_J = 25^\circ\text{C}$ , unless otherwise specified) – Sensitive SCRs**

Symbol	Test Conditions		Value		Unit
			Sxx08xS2	Sxx08xS3	
$I_{GT}$	$V_D = 6V$ $R_L = 100 \Omega$	MAX.	200	500	$\mu\text{A}$
$V_{GT}$		MAX.	0.8		V
dv/dt	$V_D = V_{DRM}$ ; $R_{GK} = 1k\Omega$ ; $T_J = 110^\circ\text{C}$	TYP.	8		V/ $\mu\text{s}$
$V_{GD}$	$V_D = V_{DRM}$ $R_L = 3.3 k\Omega$ $T_J = 110^\circ\text{C}$	MIN.	0.2		V
$V_{GRM}$	$I_{GR} = 10\mu\text{A}$	MIN.	6		V
$I_H$	$I_T = 20\text{mA}$ (initial)	MAX.	6	8	mA
$t_q$	$I_T = 2\text{A}$ ; $t_p = 50\mu\text{s}$ ; $dv/dt = 5\text{V}/\mu\text{s}$ ; $di/dt = -30\text{A}/\mu\text{s}$	MAX.	50	45	$\mu\text{s}$
$t_{gt}$	$I_G = 2 \times I_{GT}$ $PW = 15\mu\text{s}$ $I_T = 12\text{A}$	TYP.	4	5	$\mu\text{s}$

Note: xx = voltage x = package

**Electrical Characteristics ( $T_J = 25^\circ\text{C}$ , unless otherwise specified) – Standard SCRs**

Symbol	Test Conditions			Value	Unit
				Sxx08x	
$I_{GT}$	$V_D = 12V$ $R_L = 60 \Omega$		MAX.	15	mA
$V_{GT}$			MAX.	1.5	V
dv/dt	$V_D = V_{DRM}$ ; gate open; $T_J = 100^\circ\text{C}$	400V	MIN.	350	V/ $\mu\text{s}$
		600V		300	
		800V		250	
		1000V		100	
	$V_D = V_{DRM}$ ; gate open; $T_J = 125^\circ\text{C}$	400V		250	
		600V		225	
		800V		200	
$V_{GD}$	$V_D = V_{DRM}$ $R_L = 3.3 k\Omega$ $T_J = 125^\circ\text{C}$		MIN.	0.2	V
$I_H$	$I_T = 200\text{mA}$ (initial)		MAX.	30	mA
$t_q$	$I_T = 2\text{A}$ ; $t_p = 50\mu\text{s}$ ; $dv/dt = 5\text{V}/\mu\text{s}$ ; $di/dt = -30\text{A}/\mu\text{s}$		MAX.	35	$\mu\text{s}$
$t_{gt}$	$I_G = 2 \times I_{GT}$ $PW = 15\mu\text{s}$ $I_T = 16\text{A}$		TYP.	2	$\mu\text{s}$

Note: xx = voltage x = package

**Static Characteristics**

Symbol	Test Conditions			Value	Unit	
$V_{TM}$	$I_T = 16\text{A}$ ; $t_p = 380 \mu\text{s}$			MAX.	1.6 V	
$I_{DRM} / I_{RRM}$	$V_{DRM} = V_{RRM}$	Sxx08xyy	$T_J = 25^\circ\text{C}$	400 - 600V	MAX.	5
			$T_J = 110^\circ\text{C}$	400 - 600V		250
		Sxx08x	$T_J = 25^\circ\text{C}$	400 - 800V		10
				1000V		20
			$T_J = 100^\circ\text{C}$	400 - 800V		200
				1000V		3000
			$T_J = 125^\circ\text{C}$	400 - 800V		500

Note: xx = voltage, x = package, yy = sensitivity

**Thermal Resistances**

Symbol	Parameter	Value	Unit	
$R_{\theta(J-C)}$	Junction to case (AC)	Sxx08RSy	1.8	°C/W
		Sxx08LSy	3.4	
		Sxx08VSy	2.1	
		Sxx08DSy	1.5	
		Sxx08R	1.8	
		Sxx08L	3.4	
		Sxx08V	2.0	
		Sxx08D	1.5	
$R_{\theta(J-A)}$	Junction to ambient	Sxx08RSy	40	°C/W
		Sxx08LSy	65	
		Sxx08VSy	85	
		Sxx08R	40	
		Sxx08L	50	
		Sxx08V	70	

Note: xx = voltage, y = sensitivity

**Figure 1: Normalized DC Gate Trigger Current vs. Junction Temperature (Sensitive SCR)**



**Figure 2: Normalized DC Gate Trigger Current vs. Junction Temperature (Standard SCR)**



**Figure 3: Normalized DC Gate Trigger Voltage vs. Junction Temperature**



**Figure 4: Normalized DC Holding Current vs. Junction Temperature**



**Figure 5: On-State Current vs. On-State Voltage (Typical)**

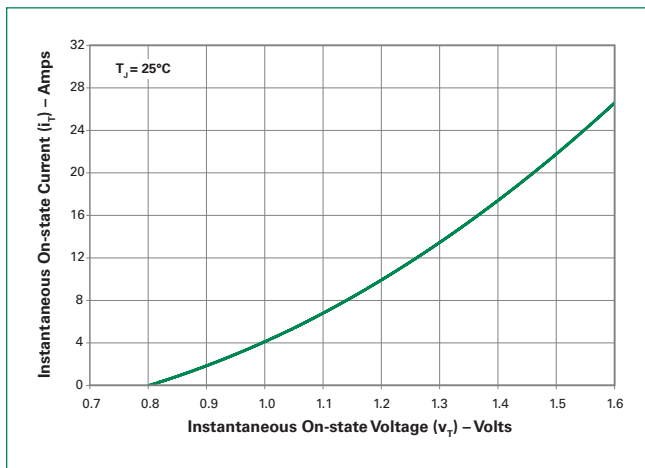

**Figure 6: Power Dissipation (Typical) vs. RMS On-State Current**

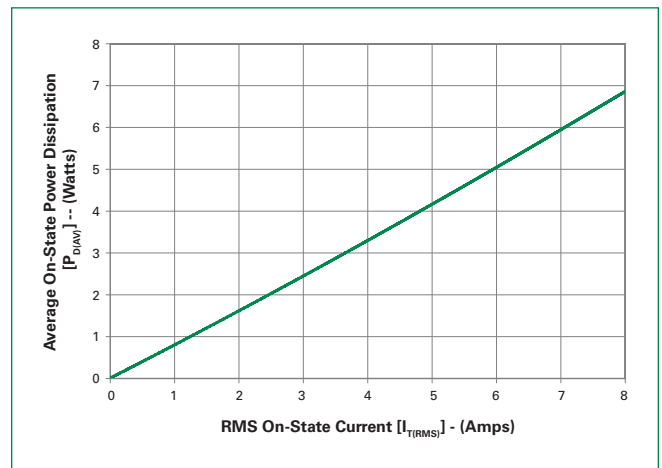

**Figure 7: Maximum Allowable Case Temperature vs. RMS On-State Current**

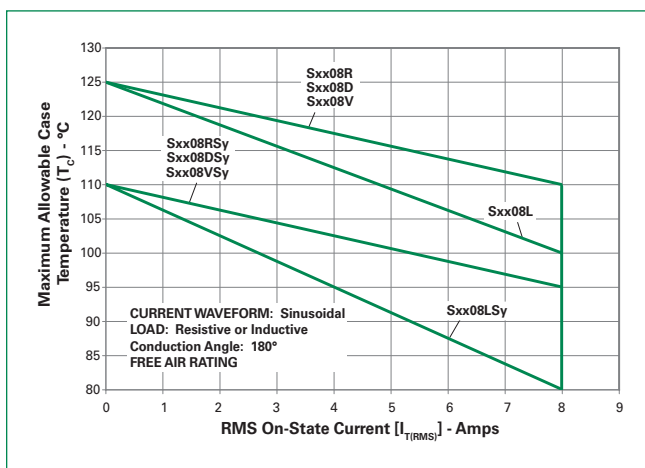

**Figure 8: Maximum Allowable Case Temperature vs. Average On-State Current**

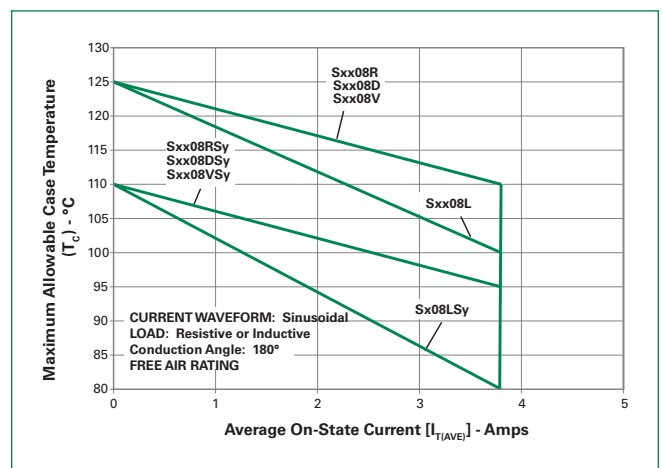

**Figure 9: Maximum Allowable Ambient Temperature vs. RMS On-State Current**



Note: xx = voltage, y = sensitivity

**Figure 10: Maximum Allowable Ambient Temperature vs. Average On-State Current**



**Figure 11: Peak Capacitor Discharge Current**



**Figure 12: Peak Capacitor Discharge Current Derating**



**Figure 13: Surge Peak On-State Current vs. Number of Cycles**

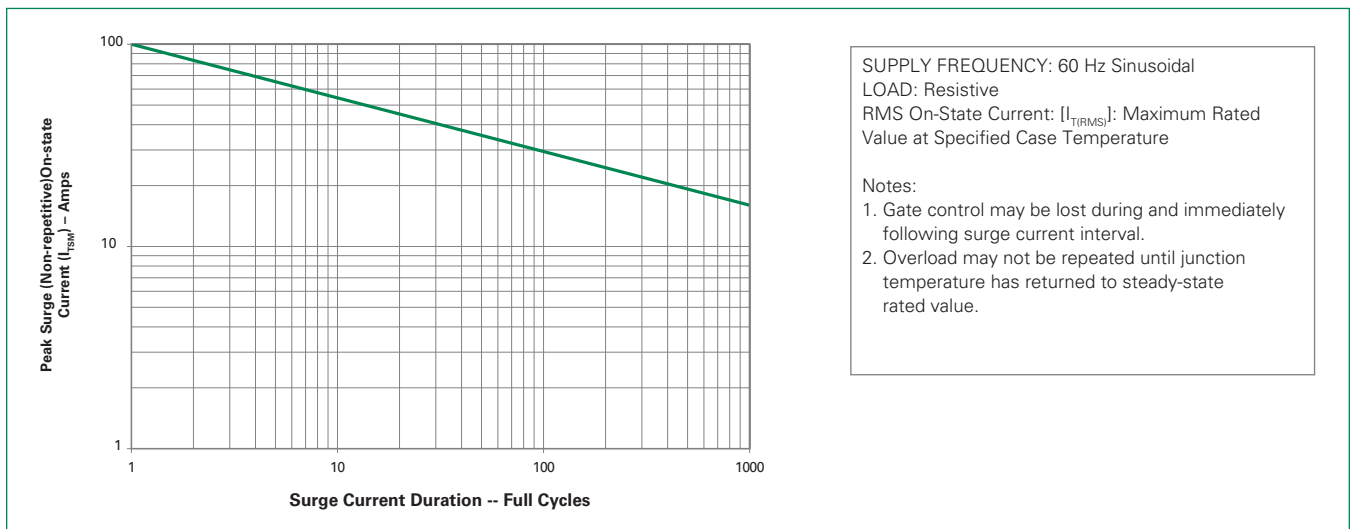

### Soldering Parameters

Reflow Condition		Pb – Free assembly
Pre Heat	- Temperature Min ( $T_{s(min)}$ )	150°C
	- Temperature Max ( $T_{s(max)}$ )	200°C
	- Time (min to max) ( $t_s$ )	60 – 180 secs
Average ramp up rate (Liquidus Temp ( $T_L$ ) to peak)		5°C/second max
$T_{s(max)}$ to $T_L$ - Ramp-up Rate		5°C/second max
Reflow	- Temperature ( $T_L$ ) (Liquidus)	217°C
	- Temperature ( $t_L$ )	60 – 150 seconds
Peak Temperature ( $T_p$ )		260 <sup>+0/-5</sup> °C
Time within 5°C of actual peak Temperature ( $t_p$ )		20 – 40 seconds
Ramp-down Rate		5°C/second max
Time 25°C to peak Temperature ( $T_p$ )		8 minutes Max.
Do not exceed		280°C



### Physical Specifications

<b>Terminal Finish</b>	100% Matte Tin-plated
<b>Body Material</b>	UL recognized epoxy meeting flammability classification 94V-0
<b>Lead Material</b>	Copper Alloy

### Design Considerations

Careful selection of the correct device for the application's operating parameters and environment will go a long way toward extending the operating life of the Thyristor. Good design practice should limit the maximum continuous current through the main terminals to 75% of the device rating. Other ways to ensure long life for a power discrete semiconductor are proper heat sinking and selection of voltage ratings for worst case conditions. Overheating, overvoltage (including dv/dt), and surge currents are the main killers of semiconductors. Correct mounting, soldering, and forming of the leads also help protect against component damage.

### Environmental Specifications

Test	Specifications and Conditions
<b>AC Blocking</b>	MIL-STD-750, M-1040, Cond A Applied Peak AC voltage @ 125°C for 1008 hours
<b>Temperature Cycling</b>	MIL-STD-750, M-1051, 100 cycles; -40°C to +150°C; 15-min dwell-time
<b>Temperature/Humidity</b>	EIA / JEDEC, JESD22-A101 1008 hours; 320V - DC: 85°C; 85% rel humidity
<b>High Temp Storage</b>	MIL-STD-750, M-1031, 1008 hours; 150°C
<b>Low-Temp Storage</b>	1008 hours; -40°C
<b>Thermal Shock</b>	MIL-STD-750, M-1056 10 cycles; 0°C to 100°C; 5-min dwell-time at each temperature; 10 sec (max) transfer time between temperature
<b>Autoclave</b>	EIA / JEDEC, JESD22-A102 168 hours (121°C at 2 ATMs) and 100% R/H
<b>Resistance to Solder Heat</b>	MIL-STD-750 Method 2031
<b>Solderability</b>	ANSI/J-STD-002, category 3, Test A
<b>Lead Bend</b>	MIL-STD-750, M-2036 Cond E

**Dimensions — TO-220AB (R-Package) — Non-Isolated Mounting Tab Common with Center Lead**



Dimension	Inches		Millimeters	
	Min	Max	Min	Max
A	0.380	0.420	9.65	10.67
B	0.105	0.115	2.67	2.92
C	0.230	0.250	5.84	6.35
D	0.590	0.620	14.99	15.75
E	0.142	0.147	3.61	3.73
F	0.110	0.130	2.79	3.30
G	0.540	0.575	13.72	14.61
H	0.025	0.035	0.64	0.89
J	0.195	0.205	4.95	5.21
K	0.095	0.105	2.41	2.67
L	0.060	0.075	1.52	1.91
M	0.085	0.095	2.16	2.41
N	0.018	0.024	0.46	0.61
O	0.178	0.188	4.52	4.78
P	0.045	0.060	1.14	1.52
R	0.038	0.048	0.97	1.22

**Dimensions — TO-220AB (L-Package) — Isolated Mounting Tab**

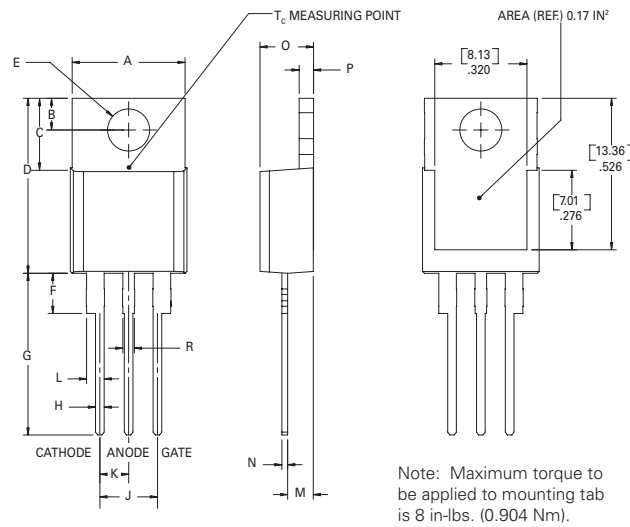

Dimension	Inches		Millimeters	
	Min	Max	Min	Max
A	0.380	0.420	9.65	10.67
B	0.105	0.115	2.67	2.92
C	0.230	0.250	5.84	6.35
D	0.590	0.620	14.99	15.75
E	0.142	0.147	3.61	3.73
F	0.110	0.130	2.79	3.30
G	0.540	0.575	13.72	14.61
H	0.025	0.035	0.64	0.89
J	0.195	0.205	4.95	5.21
K	0.095	0.105	2.41	2.67
L	0.060	0.075	1.52	1.91
M	0.085	0.095	2.16	2.41
N	0.018	0.024	0.46	0.61
O	0.178	0.188	4.52	4.78
P	0.045	0.060	1.14	1.52
R	0.038	0.048	0.97	1.22



**Dimensions — TO-251AA (V/I-Package) — V/I-PAK Through Hole**



Dimension	Inches			Millimeters		
	Min	Typ	Max	Min	Typ	Max
A	0.040	0.044	0.050	1.02	1.11	1.27
B	0.235	0.242	0.245	5.97	6.15	6.22
C	0.350	0.361	0.375	8.89	9.18	9.53
D	0.205	0.208	0.213	5.21	5.29	5.41
E	0.255	0.262	0.265	6.48	6.66	6.73
F	0.027	0.031	0.033	0.69	0.80	0.84
G	0.087	0.090	0.093	2.21	2.28	2.36
H	0.085	0.092	0.095	2.16	2.34	2.41
I	0.176	0.180	0.184	4.47	4.57	4.67
J	0.018	0.020	0.023	0.46	0.51	0.58
K	0.038	0.040	0.044	0.97	1.01	1.12
L	0.018	0.020	0.023	0.46	0.52	0.58
P	0.042	0.047	0.052	1.06	1.20	1.32
Q	0.034	0.039	0.044	0.86	1.00	1.11
R	0.034	0.039	0.044	0.86	1.00	1.11
S	0.074	0.079	0.084	1.86	2.00	2.11

**Dimensions — TO-252AA (D-Package) — D-PAK Surface Mount**



Dimension	Inches			Millimeters		
	Min	Typ	Max	Min	Typ	Max
A	0.040	0.043	0.050	1.02	1.09	1.27
B	0.235	0.243	0.245	5.97	6.16	6.22
C	0.106	0.108	0.113	2.69	2.74	2.87
D	0.205	0.208	0.213	5.21	5.29	5.41
E	0.255	0.262	0.265	6.48	6.65	6.73
F	0.027	0.031	0.033	0.69	0.80	0.84
G	0.087	0.090	0.093	2.21	2.28	2.36
H	0.085	0.092	0.095	2.16	2.33	2.41
I	0.176	0.179	0.184	4.47	4.55	4.67
J	0.018	0.020	0.023	0.46	0.51	0.58
K	0.038	0.040	0.044	0.97	1.02	1.12
L	0.018	0.020	0.023	0.46	0.51	0.58
M	0.000	0.000	0.004	0.00	0.00	0.10
N	0.021	0.026	0.027	0.53	0.67	0.69
O	0°	0°	5°	0°	0°	5°
P	0.042	0.047	0.052	1.06	1.20	1.32
Q	0.034	0.039	0.044	0.86	1.00	1.11

### Product Selector

Part Number	Voltage				Gate Sensitivity	Type	Package
	400V	600V	800V	1000V			
Sxx08RS2	X	X			0.2mA	Sensitive SCR	TO-220R
Sxx08LS2	X	X			0.2mA	Sensitive SCR	TO-220L
Sxx08VS2	X	X			0.2mA	Sensitive SCR	TO-251
Sxx08DS2	X	X			0.2mA	Sensitive SCR	TO-252
Sxx08RS3	X	X			0.5mA	Sensitive SCR	TO-220R
Sxx08LS3	X	X			0.5mA	Sensitive SCR	TO-220L
Sxx08VS3	X	X			0.5mA	Sensitive SCR	TO-251
Sxx08DS3	X	X			0.5mA	Sensitive SCR	TO-252
Sxx08R	X	X	X	X	15mA	Standard SCR	TO-220R
Sxx08L	X	X	X	X	15mA	Standard SCR	TO-220L
Sxx08V	X	X	X	X	15mA	Standard SCR	TO-251
Sxx08D	X	X	X	X	15mA	Standard SCR	TO-252

Note: xx = Voltage

### Packing Options

Part Number	Marking	Weight	Packing Mode	Base Quantity
Sxx08L/Ryy	Sxx08L/Ryy	2.2 g	Bulk	500
Sxx08L/RyyTP	Sxx08L/Ryy	2.2 g	Tube	500 (50 per tube)
Sxx08DyyTP	Sxx08Dyy	0.3 g	Tube	750 (75 per tube)
Sxx08DyyRP	Sxx08Dyy	0.3 g	Embossed Carrier	2500
Sxx08VyyTP	Sxx08Vyy	0.4 g	Tube	750 (75 per tube)
Sxx08L/R	Sxx08L/R	2.2 g	Bulk	500
Sxx08L/RTP	Sxx08L/R	2.2 g	Tube	500 (50 per tube)
Sxx08DTP	Sxx08D	0.3 g	Tube	750 (75 per tube)
Sxx08DRP	Sxx08D	0.3 g	Embossed Carrier	2500
Sxx08VTP	Sxx08V	0.4 g	Tube	750 (75 per tube)

Note: xx = Voltage; yy = Sensitivity

### TO-252 Embossed Carrier Reel Pack (RP) Specifications

Meets all EIA-481-2 Standards



### Part Numbering System



### Part Marking System

TO-220 AB – (R Package)



TO-220 AB – (L Package)



TO-251AA – (V Package)  
TO-252AA – (D Package)



Компания «Океан Электроники» предлагает заключение долгосрочных отношений при поставках импортных электронных компонентов на взаимовыгодных условиях!

Наши преимущества:

- Поставка оригинальных импортных электронных компонентов напрямую с производств Америки, Европы и Азии, а так же с крупнейших складов мира;
- Широкая линейка поставок активных и пассивных импортных электронных компонентов (более 30 млн. наименований);
- Поставка сложных, дефицитных, либо снятых с производства позиций;
- Оперативные сроки поставки под заказ (от 5 рабочих дней);
- Экспресс доставка в любую точку России;
- Помощь Конструкторского Отдела и консультации квалифицированных инженеров;
- Техническая поддержка проекта, помощь в подборе аналогов, поставка прототипов;
- Поставка электронных компонентов под контролем ВП;
- Система менеджмента качества сертифицирована по Международному стандарту ISO 9001;
- При необходимости вся продукция военного и аэрокосмического назначения проходит испытания и сертификацию в лаборатории (по согласованию с заказчиком);
- Поставка специализированных компонентов военного и аэрокосмического уровня качества (Xilinx, Altera, Analog Devices, Intersil, Interpoint, Microsemi, Actel, Aeroflex, Peregrine, VPT, Syfer, Eurofarad, Texas Instruments, MS Kennedy, Miteq, Cobham, E2V, MA-COM, Hittite, Mini-Circuits, General Dynamics и др.);

Компания «Океан Электроники» является официальным дистрибьютором и эксклюзивным представителем в России одного из крупнейших производителей разъемов военного и аэрокосмического назначения «JONHON», а так же официальным дистрибьютором и эксклюзивным представителем в России производителя высокотехнологичных и надежных решений для передачи СВЧ сигналов «FORSTAR».



## JONHON

«JONHON» (основан в 1970 г.)

Разъемы специального, военного и аэрокосмического назначения:

(Применяются в военной, авиационной, аэрокосмической, морской, железнодорожной, горно- и нефтедобывающей отраслях промышленности)

«FORSTAR» (основан в 1998 г.)

ВЧ соединители, коаксиальные кабели, кабельные сборки и микроволновые компоненты:

(Применяются в телекоммуникациях гражданского и специального назначения, в средствах связи, РЛС, а так же военной, авиационной и аэрокосмической отраслях промышленности).



Телефон: 8 (812) 309-75-97 (многоканальный)

Факс: 8 (812) 320-03-32

Электронная почта: [ocean@oceanchips.ru](mailto:ocean@oceanchips.ru)

Web: <http://oceanchips.ru/>

Адрес: 198099, г. Санкт-Петербург, ул. Калинина, д. 2, корп. 4, лит. А