

# Real Time Clock Module with I<sup>2</sup>C Bus

AB-RTCMC-32.768kHz-B5ZE-S3

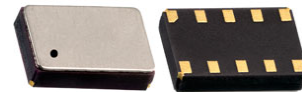

RoHS/RoHS II compliant



3.7 x 2.5 x 0.9 mm

Moisture Sensitivity Level: MSL=1

## FEATURES:

- With state-of-the-art RTC Technology by Micro Crystal AG
- RTC module with built-in crystal oscillating at 32.768 kHz
- 1 MHz Fast-mode Plus (Fm+) two-wire I2C interface
- Wide Interface operating voltage: 1.6 – 5.5 V
- Wide clock operating voltage: 1.2 – 5.5 V
- Ultra low power consumption: 130 nA typ @ 3.0V / 25°C
- Provides year, month, day, weekday, hours, minutes, seconds
- Freely programmable Alarm and Timer functions with interrupt capability
- Low voltage detector, internal power on reset
- Battery backup input pin and switch-over circuit
- INT\_1 can be programmed either as interrupt or clock output (open-drain)
- Programmable clock output for peripheral devices (32.768 kHz, 16.384 kHz, 8192 Hz, 4096 Hz, 1024 Hz, 32 Hz and 1 Hz)
- Programmable offset register for frequency adjustment
- I2C slave address: read D1h, write D0h
- Small and compact package size: 3.7 x 2.5 x 0.9 mm. RoHS-compliant and 100% leadfree

## APPLICATIONS:

- Wide range in communication & measuring equipment
- Commercial & Industrial applications
- Automotive electronics applications
- Wireless communications
- PDA and Palm Pilots
- Credit Cards with Security Technology

## STANDARD SPECIFICATIONS:

### Absolute Maximum Ratings

Parameters	Min.	Typ.	Max.	Units	Notes
Supply Voltage (V <sub>DD</sub> )	-0.5		+6.5	V	
Battery Supply voltage (V <sub>BACKUP</sub> )	-0.5		+6.5	V	
Input Voltage (V <sub>I</sub> )	-0.5		+6.5	V	
Output Voltage (V <sub>O</sub> )	-0.5		+6.5	V	
Supply Current (I <sub>DD</sub> )	-50		+50	mA	
DC Input Current (I <sub>I</sub> )	-10		+10	mA	
DC Output Current (I <sub>O</sub> )	-10		+10	mA	
Operating Temperature Range (T <sub>OPR</sub> )	-40		+85	°C	
Storage Temperature (T <sub>STO</sub> )	-55		+125	°C	Stored as bare product

### Frequency Characteristics

Parameters	Min.	Typ.	Max.	Units	Notes
Frequency Accuracy (ΔF/F)		±10	±20	ppm	T <sub>AMB</sub> =+25°C; V <sub>DD</sub> =3.0V
Frequency vs Voltage (ΔF/V)		±0.8	±1.5	ppm/V	T <sub>AMB</sub> =+25°C; V <sub>DD</sub> =1.8~5.5V
Frequency vs Temperature (ΔF/T <sub>OPR</sub> )	-0.035ppm/°C <sup>2</sup> (T <sub>OPR</sub> -T <sub>O</sub> ) <sup>2</sup> ±10%			ppm	T <sub>REF</sub> =+25°C; V <sub>DD</sub> =3.0V
Turnover Temperature (T <sub>O</sub> )	+20	+25	+30	°C	
Aging (first year)	-3		+3	ppm	T <sub>AMB</sub> =+25°C
Oscillator Start-up Time (T <sub>START</sub> )		350	500	ms	T <sub>AMB</sub> =+25°C
CLKOUT duty cycle	40	50	60	%	T <sub>AMB</sub> =+25°C



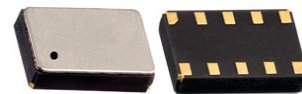

## Static Characteristics

$V_{DD} = 1.2\text{ V to }5.5\text{ V}$ ;  $V_{SS} = 0\text{ V}$ ;  $T_{AMB} = -40^{\circ}\text{C to }+85^{\circ}\text{C}$ ;  $f_{OSC} = 32.768\text{ kHz}$ ; unless otherwise specified

Parameters		Min.	Typ.	Max.	Units	Notes
Supply Voltage ( $V_{DD}$ )	For clock data integrity I <sup>2</sup> C bus inactive	1.2		5.5	V	
	I <sup>2</sup> C bus active	1.6		5.5		
	Power management function active	1.8		5.5		
Slew Rate (SR)	Of $V_{DD}$			$\pm 0.5$	V/ms	
Battery Supply Voltage ( $V_{BACKUP}$ )	Power management function active	1.8		5.5	V	
Current Consumption ( $I_{DD}$ ) I <sup>2</sup> C bus active	$f_{SCL}=1000\text{kHz}$ $V_{DD} = 3.0\text{V}$		100	200	$\mu\text{A}$	
	$f_{SCL}=100\text{kHz}$ $V_{DD} = 3.0\text{V}$		50	100	$\mu\text{A}$	
Current Consumption ( $I_{DDO}$ ) 1)	$V_{DD} = 3.0\text{V}$		130	180	nA	I <sup>2</sup> C bus inactive ( $f_{SCL}=0\text{Hz}$ ) Interrupts disabled CLKOUT disabled Power management fct. disabled (PM[2:0] = 111) $T_{amb} = +25^{\circ}\text{C}$
	$V_{DD} = 2.0\text{V}$		110	160	nA	
Current Consumption ( $I_{DDO}$ ) 1)	$V_{DD} = 2.0\text{ to }5.0\text{V}$			500	nA	I <sup>2</sup> C bus inactive ( $f_{SCL}=0\text{Hz}$ ) Interrupts disabled CLKOUT disabled Power management fct. disabled (PM[2:0] = 111) $T_{amb} = -40 \sim +85^{\circ}\text{C}$
Current Consumption ( $I_{DD32k}$ ) 2)	$V_{BACKUP}$ or $V_{DD} = 3.0\text{V}$		1200		nA	I <sup>2</sup> C bus inactive ( $f_{SCL}=0\text{Hz}$ ) Interrupts disabled CLKOUT enabled (32.768kHz) Power management fct. enabled (PM[2:0] = 000) $T_{amb} = +25^{\circ}\text{C}$
Current Consumption ( $I_{DD32k}$ ) 2)	$V_{BACKUP}$ or $V_{DD} = 2.0\text{ to }5.0\text{V}$			3600	nA	I <sup>2</sup> C bus inactive ( $f_{SCL}=0\text{Hz}$ ) Interrupts disabled CLKOUT enabled (32.768kHz) Power management fct. enabled (PM[2:0] = 000) $T_{amb} = -40 \sim +85^{\circ}\text{C}$
Battery Leakage Current ( $I_{L(bat)}$ )	$V_{DD}$ active; $V_{BACKUP}=3.0\text{V}$		50	100	nA	

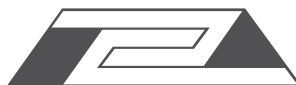

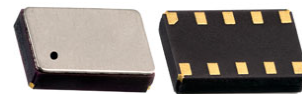

(Continued)

V<sub>DD</sub> = 1.2 V to 5.5 V; V<sub>SS</sub> = 0 V; T<sub>AMB</sub> = -40°C to +85°C; f<sub>OSC</sub> = 32.768 kHz; unless otherwise specified

Parameters	Min.	Typ.	Max.	Units	Notes
<b>Power Management</b>					
Battery Switch Threshold Voltage (V <sub>th(sw)bat</sub> )	2.28	2.5	2.7	V	
<b>Inputs</b> <sup>3)</sup>					
LOW Level Input Voltage (V <sub>IL</sub> )			30%V <sub>DD</sub>	V	
HIGH Level Input Voltage (V <sub>IH</sub> )	70%V <sub>DD</sub>			V	
Input Voltage (V <sub>I</sub> )	-0.5		V <sub>DD</sub> +0.5	V	
Input Leakage Current (I <sub>L</sub> )	V <sub>I</sub> = V <sub>DD</sub> or V <sub>SS</sub>		0	nA	
	Post ESD Event	-1		+1	μA
Input Capacitance (C <sub>I</sub> ) <sup>4)</sup>			7	pF	
<b>Outputs</b>					
Output Voltage (V <sub>O</sub> )	On pin $\overline{\text{INT}}_1$ , $\overline{\text{INT}}_2$ , CLKOUT, SDA (refers to ext. pull-up voltage)	-0.5		+5.5	V
LOW Level Output Voltage (V <sub>OL</sub> )		V <sub>SS</sub>		0.4	V
LOW Level Output Current (I <sub>OL</sub> ) <sup>5)</sup>	Output sink current; On pin $\overline{\text{INT}}_1$ , $\overline{\text{INT}}_2$ , CLKOUT V <sub>OL</sub> =0.4V; V <sub>DD</sub> =5.0V	1.5			mA
	On pin SDA V <sub>OL</sub> =0.4V; V <sub>DD</sub> =3.0V	20			mA
Output Leakage Current (I <sub>LO</sub> )	V <sub>O</sub> = V <sub>DD</sub> or V <sub>SS</sub>		0		nA
	Post ESD Event	-1		+1	μA

1) Timer source clock = 1/3600 Hz, level of pins SCL and SDA is V<sub>SS</sub> or V<sub>DD</sub>.

2) When the device is supplied via the V<sub>BACKUP</sub> pin instead of the V<sub>DD</sub> pin, the current values for I<sub>BACKUP</sub> will be as specified for I<sub>DD</sub> under the same conditions.

3) The I<sup>2</sup>C bus is 5V tolerant.

4) Implicit by design.

5) Tested on sample basis.

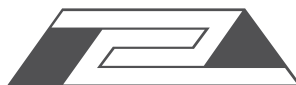

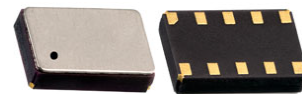

## I<sup>2</sup>C Interface Dynamic Characteristics

Parameters	Symbol	Standard Mode		Fast Mode (FM)		Fast Mode Plus (FM+) <sup>1)</sup>		Units
		Min.	Max.	Min.	Max.	Min.	Max.	
<b>Pin SCL</b>								
SCL clock frequency <sup>2)</sup>	f <sub>SCL</sub>		100		400		1000	kHz
LOW period of SCL clock	t <sub>LOW</sub>	4.7		1.3		0.5		μs
HIGH period of SCL clock	t <sub>HIGH</sub>	4.0		1.6		0.26		μs
<b>Pin SDA</b>								
Data setup time	t <sub>SU,DAT</sub>	250		100		50		ns
Data hold time	t <sub>HD,DAT</sub>	0		0		0		ns
<b>Pin SCL and SDA</b>								
Bus free time between STOP and START condition	t <sub>BUF</sub>	4.7		1.3		0.5		μs
Setup time for STOP condition	t <sub>SU,STO</sub>	4.0		0.6		0.26		μs
Hold time (repeated) START condition	t <sub>HD,STA</sub>	4.0		0.6		0.26		μs
Setup time for repeated START condition	t <sub>SU,STA</sub>	4.7		0.6		0.26		μs
Rise time of both SDA and SCL signals <sup>3)4)</sup>	t <sub>r</sub>		1000	20+0.1C <sub>b</sub>	300		120	ns
Fall time of both SDA and SCL signals <sup>3)4)</sup>	t <sub>f</sub>		300	20+0.1C <sub>b</sub>	300		120	ns
Capacitive load for each bus line	C <sub>b</sub>		400		400		550	pF
Data valid acknowledge time <sup>5)</sup>	t <sub>VD,ACK</sub>		3.45		0.9		0.45	μs
Data valid time <sup>6)</sup>	t <sub>VD,DAT</sub>		3.45		0.9		0.45	μs
Pulse width of spikes that must be suppressed by the input filter <sup>7)</sup>	t <sub>SP</sub>		50		50		50	ns

1) Fast mode plus guaranteed at 3.0 V < V<sub>DD</sub> < 5.5 V.

2) The minimum SCL clock frequency is limited by the bus time-out feature, which resets the serial bus interface if either the SDA or SCL is held LOW for a minimum of 25 ms. The bus time-out feature must be disabled for DC operation.

3) A master device must internally provide a hold time of at least 300 ns for the SDA signal (refer to the V<sub>IL</sub> of the SCL signal) in order to bridge the undefined region of the falling edge of SCL.

4) The maximum t<sub>r</sub> for the SDA and SCL bus lines is 300 ns. The maximum fall time for the SDA output stage, t<sub>f</sub> is 250 ns. This allows series protection resistors to be connected between the SDA pin, the SCL pin and the SDA/SCL bus lines without exceeding the maximum t<sub>r</sub>.

5) t<sub>VD,ACK</sub> = time for acknowledgement signal from SCL LOW to SDA output LOW.

6) t<sub>VD,DAT</sub> = minimum time for valid SDA output following SCL LOW.

7) Input filters on the SDA and SCL inputs suppress noise spikes of less than 50 ns.

## I<sup>2</sup>C Interface Timing Characteristics

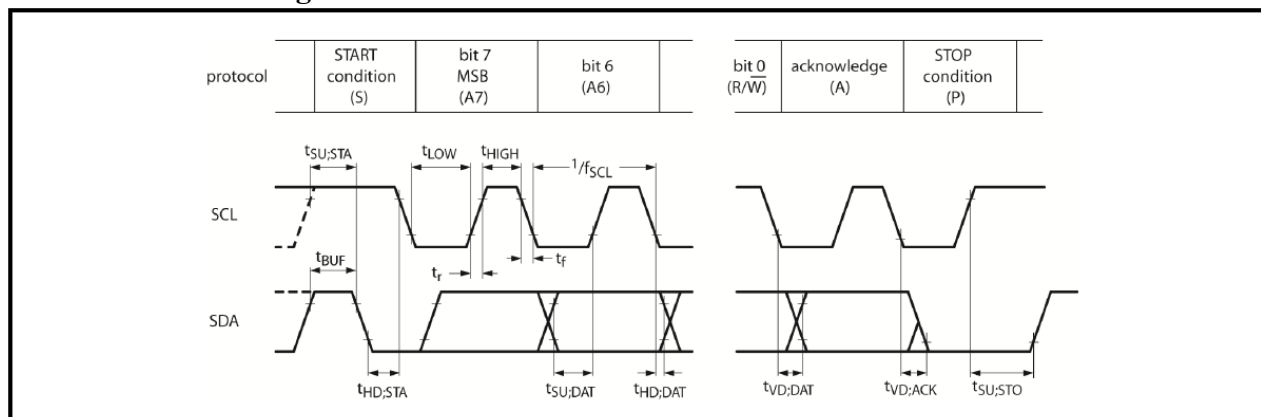

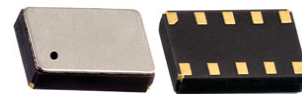

3.7 x 2.5 x 0.9 mm

AB-RTCMC-32.768kHz-B5ZE-S3



RoHS/RoHS II compliant

## PART IDENTIFICATIONS:

AB-RTCMC-32.768 kHz-B5ZE-S3-



### Packaging

Blank: Bulk

T: 1000pcs/reel

## OUTLINE DIMENSIONS:

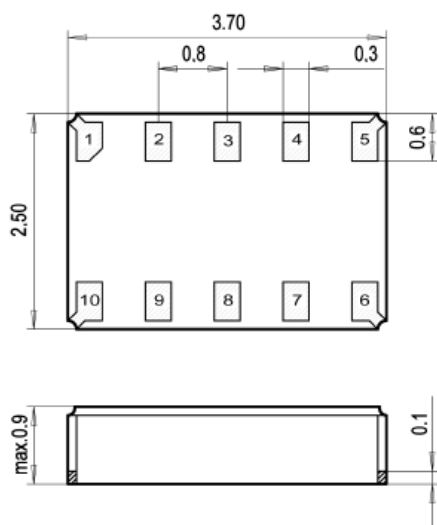

### Recommended Land Pattern

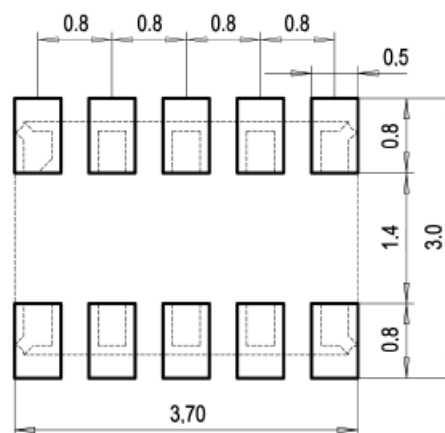

Dimensions: mm

## PIN DESCRIPTIONS:

Pin No.	Pin Name	Function
1	V <sub>DD</sub>	Power Supply Voltage
2	INT_1	Interrupt _1 Output pin
3	SCL	Serial Clock Input pin
4	SDA	Serial Data Input-Output pin
5	CLKOUT	Clock Output pin; push-pull
6	INT_2	Interrupt _2 Output pin
7	V <sub>SS</sub>	Ground
8	V <sub>BACKUP</sub>	Backup Supply Voltage
9	N.C.	Not Connected
10	N.C.	Not Connected



# Real Time Clock Module with I<sup>2</sup>C Bus

AB-RTCMC-32.768kHz-B5ZE-S3



RoHS/RoHS II compliant

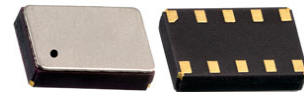

3.7 x 2.5 x 0.9 mm

## BLOCK DIAGRAM:

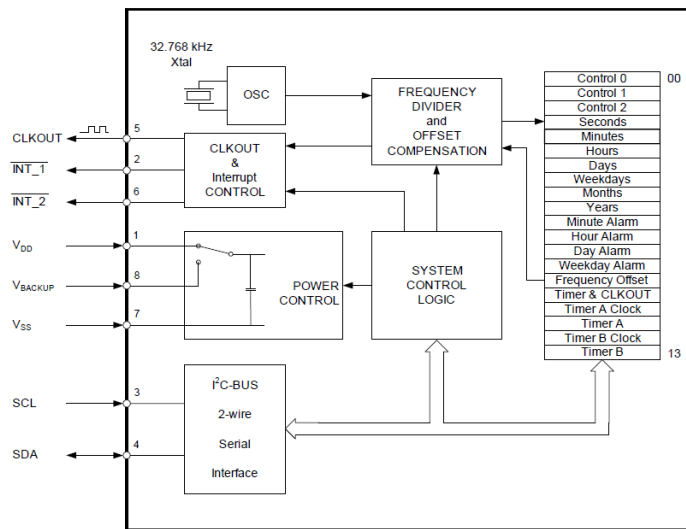

## RECOMMENDED REFLOW PROFILE:

Maximum Reflow Conditions in accordance with IPC/JEDEC J-STD-020C “Pb-free”

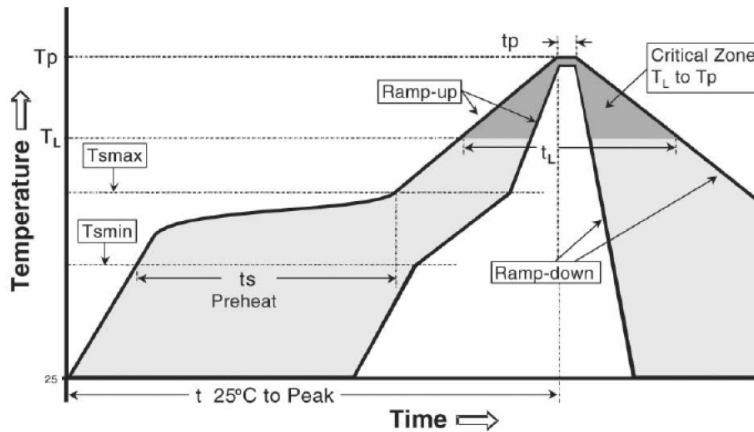

Temperature	Conditions	Units
Average Ramp-up Rate (T <sub>Smax</sub> to T <sub>P</sub> )	3°C/second max	°C/s
Ramp Down Rate (T <sub>cool</sub> )	6°C/second max	°C/s
Time 25°C to Peak Temperature (T <sub>to-peak</sub> )	8 minutes max	m
<b>Preheat</b>		
Temperature Min (T <sub>Smin</sub> )	150	°C
Temperature Max (T <sub>Smax</sub> )	200	°C
Time T <sub>Smin</sub> to T <sub>Smax</sub> (t <sub>s</sub> )	60 ~ 180	sec
<b>Time Above Liquidus</b>		
Temperature Liquidus (T <sub>L</sub> )	217	°C
Time above Liquidus (t <sub>L</sub> )	60 ~ 150	sec
<b>Peak Temperature</b>		
Peak Temperature (T <sub>P</sub> )	260	°C
Time within 5°C of Peak Temperature (t <sub>p</sub> )	20 ~ 40	sec

# Real Time Clock Module with I<sup>2</sup>C Bus

AB-RTCMC-32.768kHz-B5ZE-S3



RoHS/RoHS II compliant

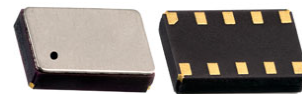

3.7 x 2.5 x 0.9 mm

## TAPE & REEL:

T = 1000pcs/reel

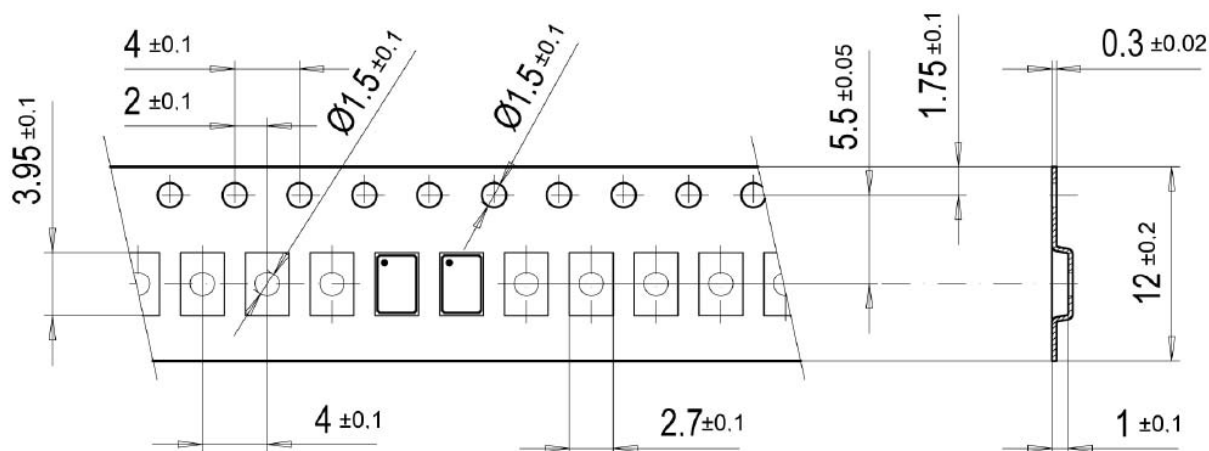

➔ User Direction of Feed

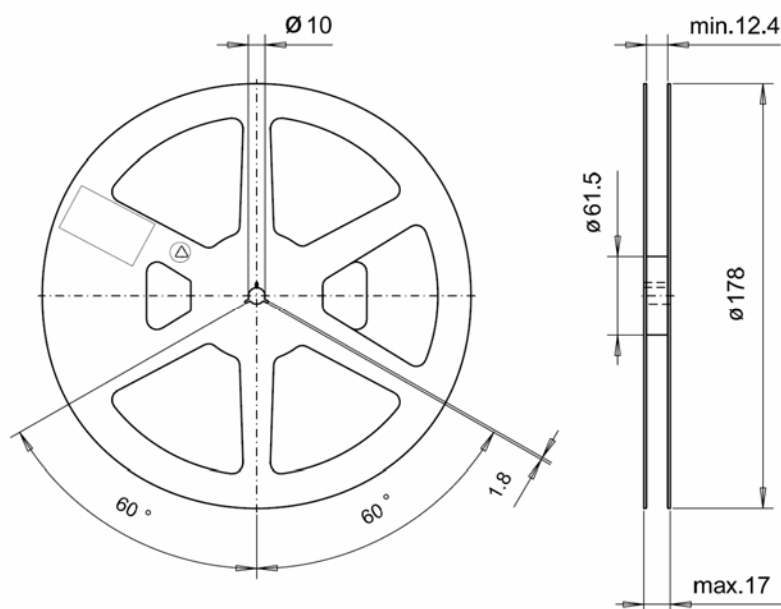

Dimension: mm

**ATTENTION:** Abracon Corporation's products are COTS – Commercial-Off-The-Shelf products; suitable for Commercial, Industrial and, where designated, Automotive Applications. Abracon's products are not specifically designed for Military, Aviation, Aerospace, Life-dependant Medical applications or any application requiring high reliability where component failure could result in loss of life and/or property. For applications requiring high reliability and/or presenting an extreme operating environment, written consent and authorization from Abracon Corporation is required. Please contact Abracon Corporation for more information.

ABRACON IS  
ISO 9001 : 2008  
CERTIFIED



Visit [www.abracon.com](http://www.abracon.com) for Terms & Conditions of Sale **Revised: 02.05.13**  
30332 Esperanza, Rancho Santa Margarita, California 92688  
tel 949-546-8000 | fax 949-546-8001 | [www.abracon.com](http://www.abracon.com)



Компания «Океан Электроники» предлагает заключение долгосрочных отношений при поставках импортных электронных компонентов на взаимовыгодных условиях!

Наши преимущества:

- Поставка оригинальных импортных электронных компонентов напрямую с производств Америки, Европы и Азии, а так же с крупнейших складов мира;
- Широкая линейка поставок активных и пассивных импортных электронных компонентов (более 30 млн. наименований);
- Поставка сложных, дефицитных, либо снятых с производства позиций;
- Оперативные сроки поставки под заказ (от 5 рабочих дней);
- Экспресс доставка в любую точку России;
- Помощь Конструкторского Отдела и консультации квалифицированных инженеров;
- Техническая поддержка проекта, помощь в подборе аналогов, поставка прототипов;
- Поставка электронных компонентов под контролем ВП;
- Система менеджмента качества сертифицирована по Международному стандарту ISO 9001;
- При необходимости вся продукция военного и аэрокосмического назначения проходит испытания и сертификацию в лаборатории (по согласованию с заказчиком);
- Поставка специализированных компонентов военного и аэрокосмического уровня качества (Xilinx, Altera, Analog Devices, Intersil, Interpoint, Microsemi, Actel, Aeroflex, Peregrine, VPT, Syfer, Eurofarad, Texas Instruments, MS Kennedy, Miteq, Cobham, E2V, MA-COM, Hittite, Mini-Circuits, General Dynamics и др.);

Компания «Океан Электроники» является официальным дистрибьютором и эксклюзивным представителем в России одного из крупнейших производителей разъемов военного и аэрокосмического назначения «JONHON», а так же официальным дистрибьютором и эксклюзивным представителем в России производителя высокотехнологичных и надежных решений для передачи СВЧ сигналов «FORSTAR».



## JONHON

«JONHON» (основан в 1970 г.)

Разъемы специального, военного и аэрокосмического назначения:

(Применяются в военной, авиационной, аэрокосмической, морской, железнодорожной, горно- и нефтедобывающей отраслях промышленности)

«FORSTAR» (основан в 1998 г.)

ВЧ соединители, коаксиальные кабели, кабельные сборки и микроволновые компоненты:

(Применяются в телекоммуникациях гражданского и специального назначения, в средствах связи, РЛС, а так же военной, авиационной и аэрокосмической отраслях промышленности).



Телефон: 8 (812) 309-75-97 (многоканальный)

Факс: 8 (812) 320-03-32

Электронная почта: [ocean@oceanchips.ru](mailto:ocean@oceanchips.ru)

Web: <http://oceanchips.ru/>

Адрес: 198099, г. Санкт-Петербург, ул. Калинина, д. 2, корп. 4, лит. А