

### STEP-UP DC/DC CONVERTER FOR OLED BACK LIGHT with SHUTDOWN FUNCTION

NO.EA-192-140530

## OUTLINE

R1200x series are CMOS-based control type step-up DC/DC converter with low supply current ICs. Each of these ICs consists of a Nch MOSFET, NPN transistor, an oscillator, PWM comparator, a voltage reference unit, an error amplifier, a current limit circuit, an under voltage lockout circuit (UVLO), an over voltage protection circuit (OVP), and a soft start circuit. As the external components, an inductor, resistances or capacitors are necessary to make a constant output voltage of step-up DC/DC converter with the R1200x. At standby mode, the NPN transistor can separate the output from the input. During the situation of that, there are two versions. R1200xxxxA: the output of  $V_{OUT}$  is generated to 0V by the low resistance (with the auto discharge function). R1200xxxxB does not generate the output of  $V_{OUT}$  (without the auto discharge function).

The soft-start time (Typ. 1.5ms) and the maximum duty cycle (Typ. 91%) are set internally. For the protection functions of R1200x series are the current limit function of the  $L_x$  peak current, the OVP function for detection the over voltage of output and the UVLO function for protective miss-operation by the low voltage. (The threshold of OVP is selectable from 17V, 19V or 21V.)

Since the packages for these ICs are DFN1616-6, DFN(PLP)1820-6, SOT-23-6 and WLCSP-6-P1, therefore high density mounting of the ICs on boards is possible.

## FEATURES

- Supply Current ..... Typ. 500 $\mu$ A
- Standby Current ..... Max. 3 $\mu$ A
- Input Voltage Range ..... 2.3V to 5.5V
- Feedback Voltage ..... 1.0V (Externally adjustable)
- Feedback Voltage Accuracy .....  $\pm 1.5\%$
- Temperature-Drift Coefficient of Feedback Voltage .....  $\pm 150$ ppm/ $^{\circ}$ C
- Oscillator Frequency ..... Typ. 1.2MHz
- Maximum Duty Cycle ..... Typ. 91%
- Switch ON Resistance ..... Typ. 1.35 $\Omega$
- UVLO Detector Threshold ..... Typ. 2.0V
- Soft-start Time ..... Typ. 1.5ms
- $L_x$  Current Limit Protection ..... Typ. 700mA
- OVP Detector Threshold ..... 17V, 19V, 21V
- Switching Control ..... PWM
- Built-in a rectifier NPN transistor, at standby mode, complete shutdown is possible.
- Built-in Auto discharge function ..... A version
- Packages ..... DFN1616-6, DFN(PLP)1820-6, SOT-23-6,  
WLCSP-6-P1
- Ceramic capacitors are recommended ..... 1 $\mu$ F

## APPLICATION

- OLED power supply for portable equipment
- White LED Backlight for portable equipment

R1200x

BLOCK DIAGRAMS

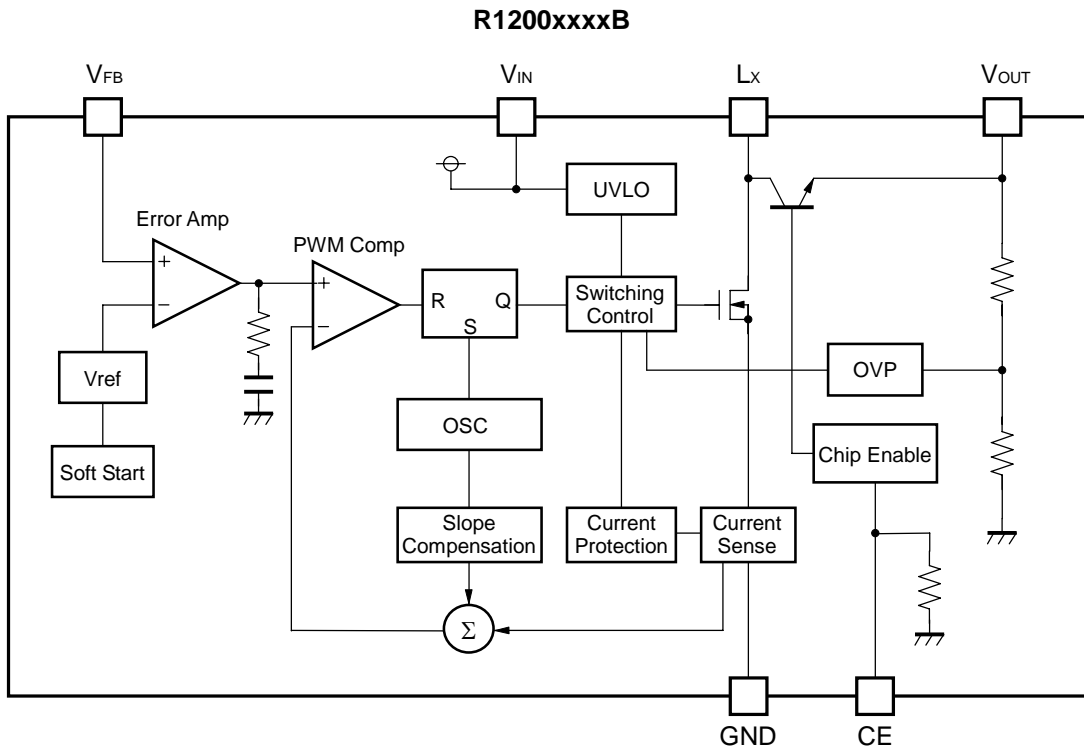
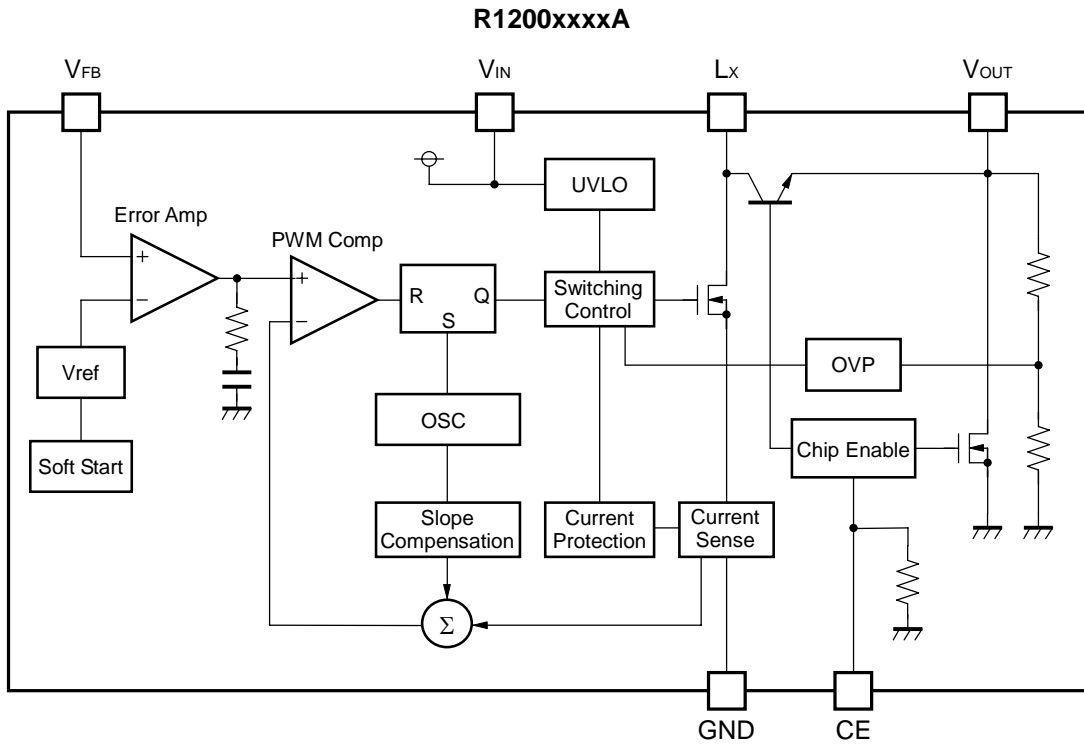

\* R1200Z (WLCSP-6-P1) is the limited product. As of March in 2014.

**R1200x**

## SELECTION GUIDE

The OVP threshold voltage, auto discharge function, and the package for the ICs can be selected at the user's request.

Product Name	Package	Quantity per Reel	Pb Free	Halogen Free
R1200Zxxx*-E2-F	WLCSP-6-P1	5,000 pcs	Yes	Yes
R1200Lxxx*-TR	DFN1616-6	5,000 pcs	Yes	Yes
R1200Kxxx*-TR	DFN(PLP)1820-6	5,000 pcs	Yes	Yes
R1200Nxxx*-TR-FE	SOT-23-6	3,000 pcs	Yes	Yes
xxx : Designation of OVP detector threshold (001) 17V threshold of OVP (002) 19V threshold of OVP (003) 21V threshold of OVP				
* : The auto discharge function at off state are options as follows. (A) with auto discharge function at off state (B) without auto discharge function at off state				

## PIN CONFIGURATIONS

### • WLCSP-6-P1

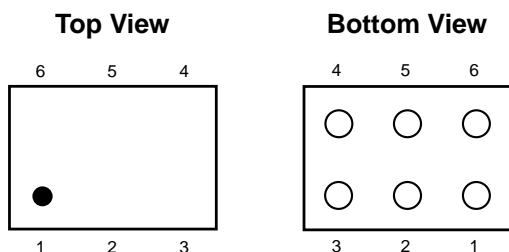

### • DFN1616-6

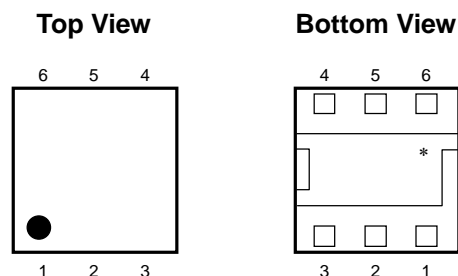

### • DFN(PLP)1820-6

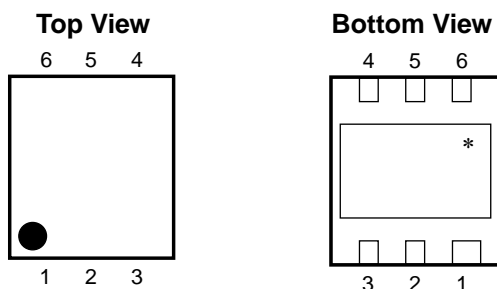

### • SOT-23-6

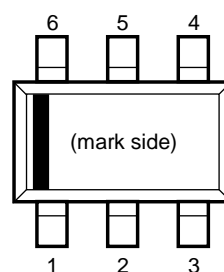

## PIN DESCRIPTIONS

### • WLCSP-6-P1

Pin No	Symbol	Pin Description
1	LX	Switching Pin (Open Drain Output)
2	V <sub>IN</sub>	Power Supply Input Pin
3	V <sub>FB</sub>	Feedback Pin
4	CE	Chip Enable Pin ("H" Active)
5	V <sub>OUT</sub>	Output Pin
6	GND	Ground Pin

### • DFN1616-6, DFN(PLP)1820-6

Pin No	Symbol	Pin Description
1	CE	Chip Enable Pin ("H" Active)
2	V <sub>FB</sub>	Feedback Pin
3	LX	Switching Pin (Open Drain Output)
4	GND	Ground Pin
5	V <sub>DD</sub>	Input Pin
6	V <sub>OUT</sub>	Output Pin

\*) Tab is GND level. (They are connected to the reverse side of this IC.)

The tab is better to be connected to the GND, but leaving it open is also acceptable.

\* R1200Z (WLCSP-6-P1) is the limited product. As of March in 2014.

R1200x

• SOT-23-6

Pin No	Symbol	Pin Description
1	CE	Chip Enable Pin ("H" Active)
2	V <sub>OUT</sub>	Output Pin
3	V <sub>DD</sub>	Input Pin
4	L <sub>X</sub>	Switching Pin (Open Drain Output)
5	GND	Ground Pin
6	V <sub>FB</sub>	Feedback Pin

## ABSOLUTE MAXIMUM RATINGS

GND=0V

Symbol	Item	Rating	Unit
V <sub>IN</sub>	V <sub>IN</sub> Pin Voltage	-0.3 to 6.5	V
V <sub>CE</sub>	CE Pin Voltage	-0.3 to V <sub>IN</sub> +0.3	V
V <sub>FB</sub>	V <sub>FB</sub> Pin Voltage	-0.3 to V <sub>IN</sub> +0.3	V
V <sub>OUT</sub>	V <sub>OUT</sub> Pin Voltage	-0.3 to 25.0	V
V <sub>LX</sub>	L <sub>X</sub> Pin Voltage	-0.3 to 25.0	V
I <sub>LX</sub>	L <sub>X</sub> Pin Current	1000	mA
P <sub>D</sub>	Power Dissipation (WLCSP-6-P1)*	633	mW
	Power Dissipation (DFN1616-6)*	640	
	Power Dissipation (DFN(PLP)1820-6)*	880	
	Power Dissipation (SOT-23-6)*	420	
T <sub>opt</sub>	Operating Temperature Range	-40 to 85	°C
T <sub>stg</sub>	Storage Temperature Range	-55 to 125	°C

\*) For Power Dissipation, please refer to PACKAGE INFORMATION.

### ABSOLUTE MAXIMUM RATINGS

Electronic and mechanical stress momentarily exceeded absolute maximum ratings may cause the permanent damages and may degrade the life time and safety for both device and system using the device in the field. The functional operation at or over these absolute maximum ratings is not assured.

## R1200x

### ELECTRICAL CHARACTERISTICS

• R1200x

T<sub>opt</sub>=25°C

Symbol	Item	Conditions	Min.	Typ.	Max.	Unit	
V <sub>IN</sub>	Operating Input Voltage		2.3		5.5	V	
I <sub>DD</sub>	Supply Current	V <sub>IN</sub> =5.5V, V <sub>FB</sub> =0V, Lx at no load		0.5	1.0	mA	
I <sub>standby</sub>	Standby Current	V <sub>IN</sub> =5.5V, V <sub>CE</sub> =0V		0	3.0	μA	
V <sub>UVLO1</sub>	UVLO Detector Threshold	V <sub>IN</sub> falling	1.9	2.0	2.1	V	
V <sub>UVLO2</sub>	UVLO Released Voltage	V <sub>IN</sub> rising		V <sub>UVLO1</sub> +0.10	2.25	V	
V <sub>CEH</sub>	CE Input Voltage "H"	V <sub>IN</sub> =5.5V	1.5			V	
V <sub>CEL</sub>	CE Input Voltage "L"	V <sub>IN</sub> =2.3V			0.5	V	
R <sub>CE</sub>	CE Pull Down Resistance	V <sub>IN</sub> =3.6V	600	1200	2200	kΩ	
V <sub>FB</sub>	V <sub>FB</sub> Voltage Accuracy	V <sub>IN</sub> =3.6V	0.985	1.0	1.015	V	
ΔV <sub>FB</sub> / ΔT <sub>opt</sub>	V <sub>FB</sub> Voltage Temperature Coefficient	V <sub>IN</sub> =3.6V, -40°C ≤ T <sub>opt</sub> ≤ 85°C		±150		ppm /°C	
I <sub>FB</sub>	V <sub>FB</sub> Input Current	V <sub>IN</sub> =5.5V, V <sub>FB</sub> =0V or 5.5V	-0.1		0.1	μA	
t <sub>start</sub>	Soft-start Time	V <sub>IN</sub> =3.6V		1.5		ms	
R <sub>ON</sub>	Switch ON Resistance	V <sub>IN</sub> =3.6V, I <sub>SW</sub> =100mA		1.35		Ω	
I <sub>LXleak</sub>	Switch Leakage Current			0	3.0	μA	
I <sub>LXlim</sub>	Switch Current Limit	V <sub>IN</sub> =3.6V	400	700	1000	mA	
V <sub>NPN</sub>	NPN V <sub>CE</sub> Voltage	I <sub>NPN</sub> =100mA		0.8		V	
I <sub>NPNOFF1</sub>	NPN Leakage Current 1	V <sub>OUT</sub> =23V			10	μA	
I <sub>NPNOFF2</sub>	NPN Leakage Current 2	V <sub>OUT</sub> =0V, V <sub>LX</sub> =5.5V			3.0	μA	
f <sub>osc</sub>	Oscillator Frequency	V <sub>IN</sub> =3.6V, V <sub>OUT</sub> =V <sub>FB</sub> =0V	1.0	1.2	1.4	MHz	
Maxduty	Maximum Duty Cycle	V <sub>IN</sub> =3.6V, V <sub>OUT</sub> =V <sub>FB</sub> =0V	86	91		%	
V <sub>OVP1</sub>	OVP Detector Threshold	V <sub>IN</sub> =3.6V, V <sub>OUT</sub> rising	R1200x001x	16	17	18	V
			R1200x002x	18	19	20	
			R1200x003x	20	21	22	
V <sub>OVP2</sub>	OVP Released Voltage	V <sub>IN</sub> =3.6V, V <sub>OUT</sub> falling		V <sub>OVP1</sub> -1.1		V	
I <sub>DISCHG</sub>	V <sub>OUT</sub> Discharge Current	V <sub>IN</sub> =3.6V, V <sub>OUT</sub> =0.1V	R1200xxxxA	0.7		mA	
I <sub>VOUT</sub>	OVP Sense Current	V <sub>IN</sub> =3.6V, V <sub>OUT</sub> =23V		6.0		μA	

#### RECOMMENDED OPERATING CONDITIONS (ELECTRICAL CHARACTERISTICS)

All of electronic equipment should be designed that the mounted semiconductor devices operate within the recommended operating conditions. The semiconductor devices cannot operate normally over the recommended operating conditions, even if when they are used over such conditions by momentary electronic noise or surge. And the semiconductor devices may receive serious damage when they continue to operate over the recommended operating conditions.

## TYPICAL APPLICATIONS

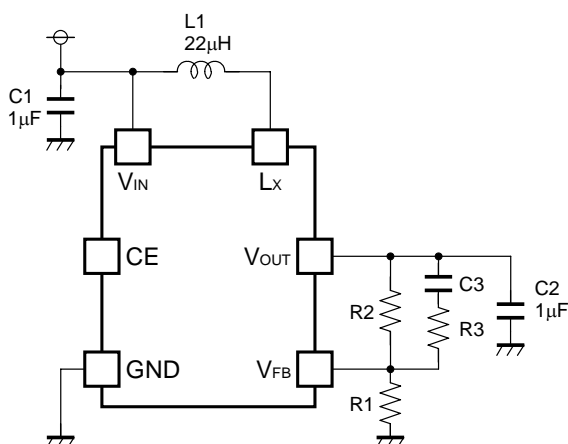

Symbol	Parts Recommendation
L1	22µH LQH32CN220K53L (Murata)
C1	1µF
C2	1µF GRM21BR11E105K (Murata)
C3	220pF
R1, R2	For V <sub>OUT</sub> setting
R3	2kΩ

### ● The Method of Output Voltage Setting

- The output voltage can be calculated with divider resistors (R1 and R2) values as the following formula:

$$\text{Output Voltage} = V_{\text{FB}} \times (R1 + R2) / R1$$

- The total value of R1 and R2 should be equal or less than 300kΩ. Make the V<sub>IN</sub> and GND line sufficient. The large current flows through the V<sub>IN</sub> and GND line due to the switching. If this impedance (V<sub>IN</sub> and GND line) is high, the internal voltage of the IC may shift by the switching current, and the operating may become unstable. Moreover, when the built-in L<sub>x</sub> switch is turn OFF, the spike noise caused by the inductor may be generated. As a result of this, recommendation voltage rating of capacitor (C2) value is equal 1.5 times larger or more than the setting output voltage.

### ● Shutdown

- At standby mode, the output is completely separated from the input and shutdown by the NPN transistor of internal IC. However, the leakage current is generated when the L<sub>x</sub> pin voltage is equal or more than V<sub>IN</sub> pin voltage at standby mode.
- R1200xxxxA (with auto discharge function): In the term of standby mode, the switch is turned ON between V<sub>OUT</sub> to GND and the V<sub>OUT</sub> capacitor is discharged.
- R1200xxxxB (without auto discharge function): The built-in switch for discharge does not turn on, but the OVP sense resistors between V<sub>OUT</sub> and GND exists as same as A version.
- However, the both version (A/B) has the OVP sense resistance (4 to 5MΩ) between V<sub>OUT</sub> and GND (refer to OVP sense current (I<sub>VOUT</sub>) on ELECTRICAL CHARACTERISTICS table) and the current flows through from V<sub>OUT</sub> to GND.

### ● Selection of external components

- The recommendation of capacitor value for C1 is in the range from 1µF to 4.7µF. Connect C1 with a capacitance value between V<sub>IN</sub> and GND pin, and as close as possible to the pins.
- Connect a capacitor in the range from 1µF to 4.7µF between V<sub>OUT</sub> and GND pins.
- The recommendation of inductance value is in the range from 4.7µH - 22µH. Choose an inductor of which the DC resistance is small enough and the permissible current is large enough and be hard for magnetic saturation. If the inductance value is too small, at the maximum load the peak current may be large and reach the current limit of L<sub>x</sub>. (Refer to the item of the operation of the DC/DC converter and output current.)

---

## R1200x

---

- If the spike noise of  $V_{OUT}$  may be large, the spike noise may be picked into  $V_{FB}$  pin and make the operation unstable. In this case, use a R3 of the resistance value in the range from  $1k\Omega$  to  $5k\Omega$  to reduce a noise level of  $V_{FB}$ .
- \* The performance of power source circuits using these ICs extremely depends upon the peripheral circuits. Pay attention in the selection of the peripheral circuits. In particular, design the peripheral circuits in a way that the values such as voltage, current, and power of each component, PCB patterns and the IC do not exceed their respected rated values.



## OPERATION OF STEP-UP DC/DC CONVERTER AND OUTPUT CURRENT

<Basic Circuit>

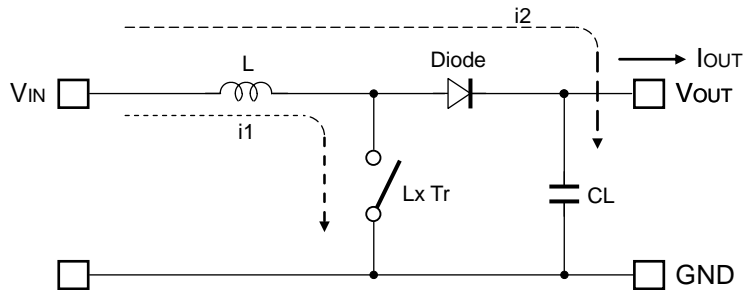

<Current through L>

Discontinuous mode

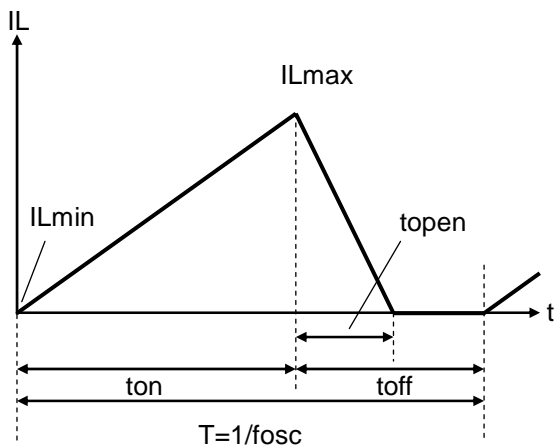

Continuous mode

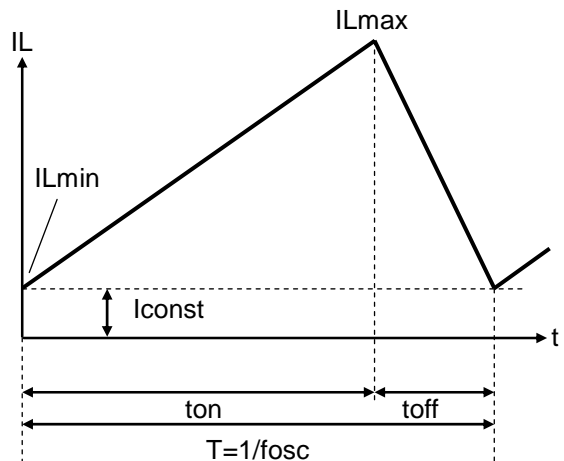

There are two operation modes of the step-up PWM control-DC/DC converter. That is the continuous mode and discontinuous mode by the continuousness inductor.

When the transistor turns ON, the voltage of inductor L becomes equal to  $V_{IN}$  voltage. The increase value of inductor current ( $i_1$ ) will be

$$\Delta i_1 = V_{IN} \times t_{on} / L \dots\dots\dots \text{Formula 1}$$

As the step-up circuit, during the OFF time (when the transistor turns OFF) the voltage is continually supply from the power supply. The decrease value of inductor current ( $i_2$ ) will be

$$\Delta i_2 = (V_{OUT} - V_{IN}) \times t_{open} / L \dots\dots\dots \text{Formula 2}$$

At the PWM control-method, the inductor current become continuously when  $t_{open} = t_{off}$ , the DC/DC converter operate as the continuous mode.

---

## R1200x

---

In the continuous mode, the variation of current of  $i_1$  and  $i_2$  is same at regular condition.

$$V_{IN} \times t_{on} / L = (V_{OUT} - V_{IN}) \times t_{off} / L \dots \dots \dots \text{Formula 3}$$

The duty at continuous mode will be

$$\text{duty (\%)} = t_{on} / (t_{on} + t_{off}) = (V_{OUT} - V_{IN}) / V_{OUT} \dots \dots \dots \text{Formula 4}$$

The average value of inductor current ( $i_1$ ) when  $t_{open}=t_{off}$  will be

$$i_1 (\text{Ave.}) = V_{IN} \times t_{on} / (2 \times L) \dots \dots \dots \text{Formula 5}$$

If the input power is equal to the output power, it becomes the continuous mode if the  $I_{OUT}$  value is larger than the value will be calculated by following formula.

$$I_{OUT} = V_{IN}^2 \times t_{on} / (2 \times L \times V_{OUT}) \dots \dots \dots \text{Formula 6}$$

The peak current ( $I_{Lmax}$ ) of inductor will be

$$I_{Lmax} = I_{OUT} \times V_{OUT} / V_{IN} + V_{IN} \times t_{on} / (2 \times L)$$
$$I_{Lmax} = I_{OUT} \times V_{OUT} / V_{IN} + V_{IN} \times T \times (V_{OUT} - V_{IN}) / (2 \times L \times V_{OUT}) \dots \dots \dots \text{Formula 7}$$

The peak current value is larger than the  $I_{OUT}$  value. In case of this, selecting the condition of the input and the output and the external components by considering of  $I_{Lmax}$  value.

The explanation above is based on the ideal calculation, and the loss caused by  $L_x$  switch and the external components are not included.

The actual maximum output current will be between 50% and 80% by the above calculations. Especially, when the  $I_L$  is large or  $V_{IN}$  is low, the loss of  $V_{IN}$  is generated with on resistance of the switch.

## TYPICAL CHARACTERISTICS

### 1) Output Voltage vs. Output Current (L=22μH)

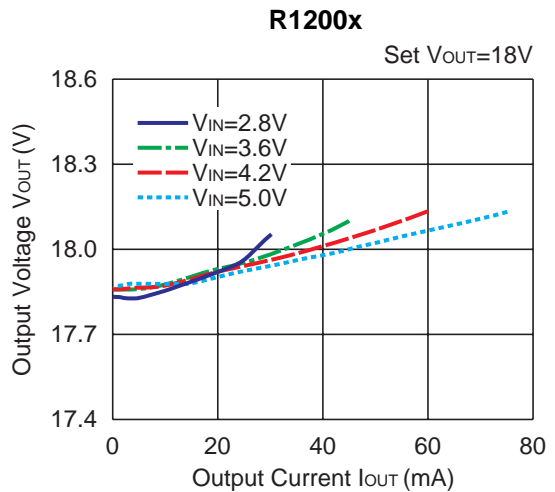
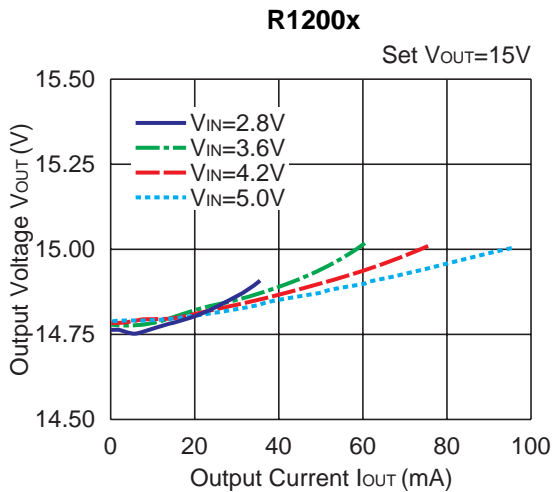
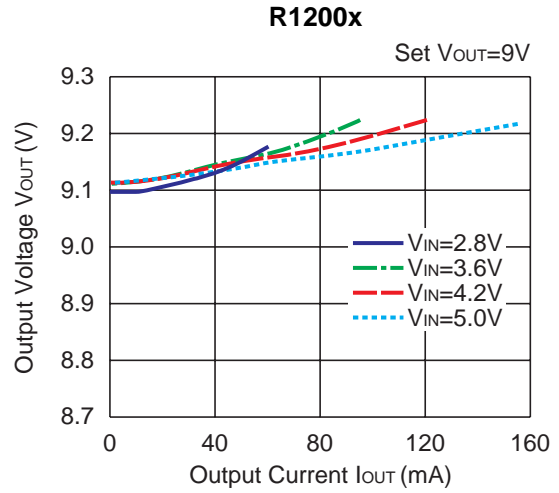
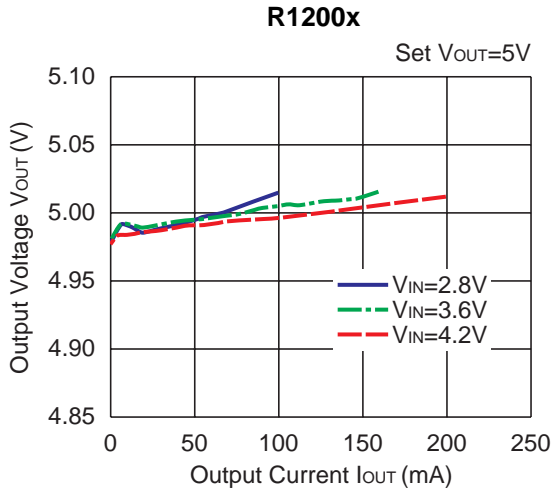

### 2) Efficiency vs. Output Current

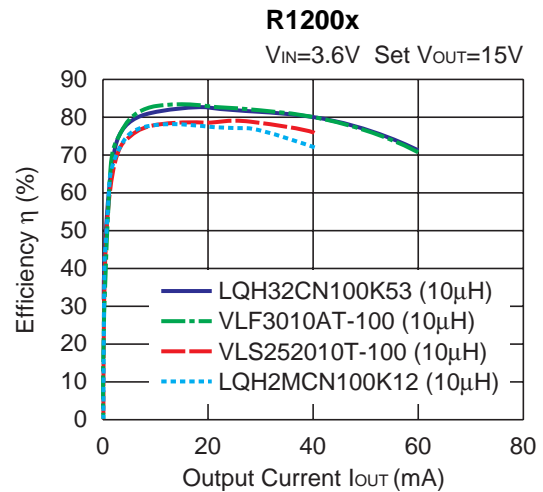
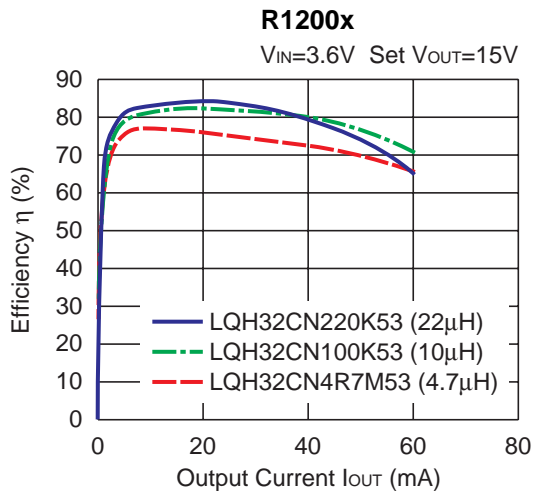

**R1200x**

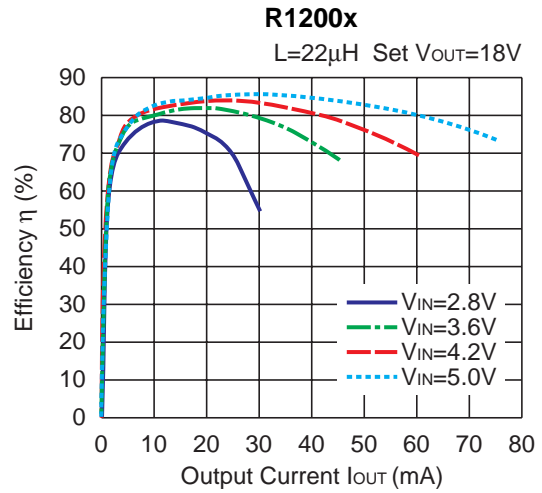
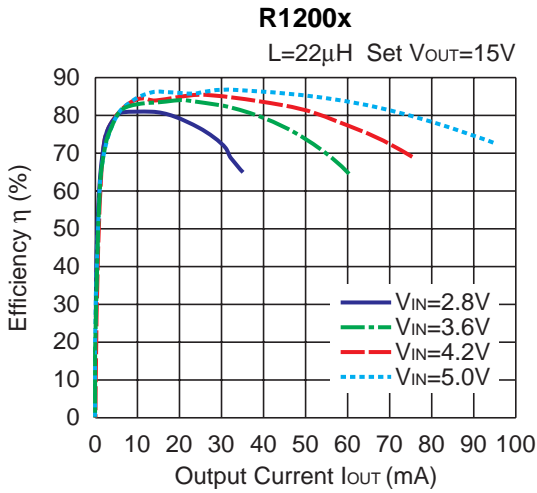
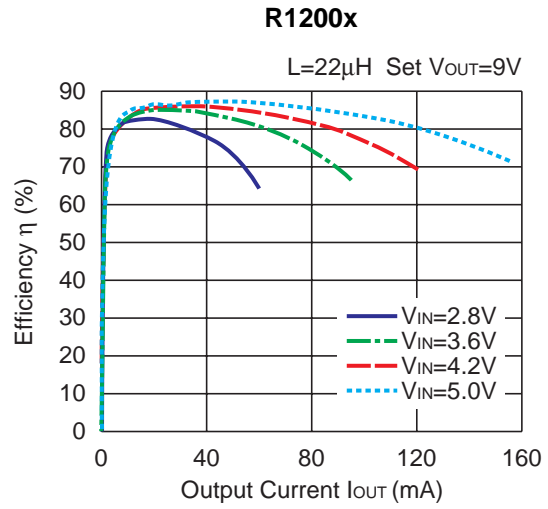
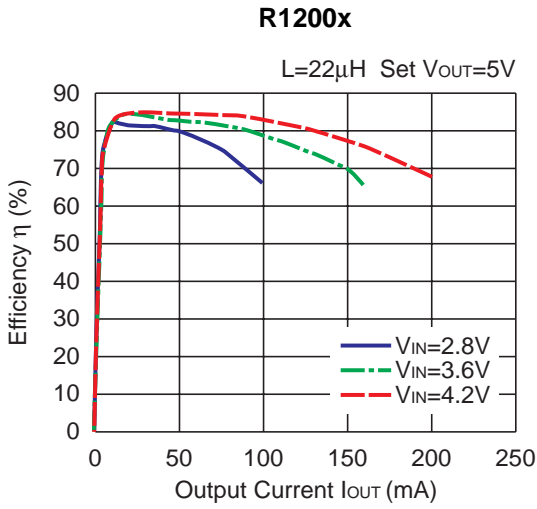

**3) OVP Sense Current vs. Temperature**

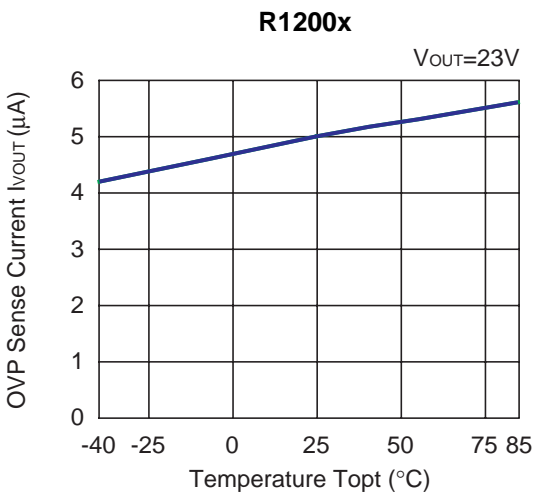

**4) Supply Current vs. Temperature**

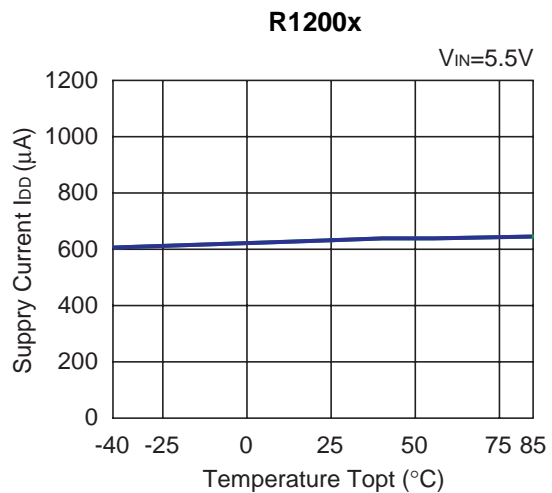

5) CE Pulldown Resistance vs. Temperature

R1200x

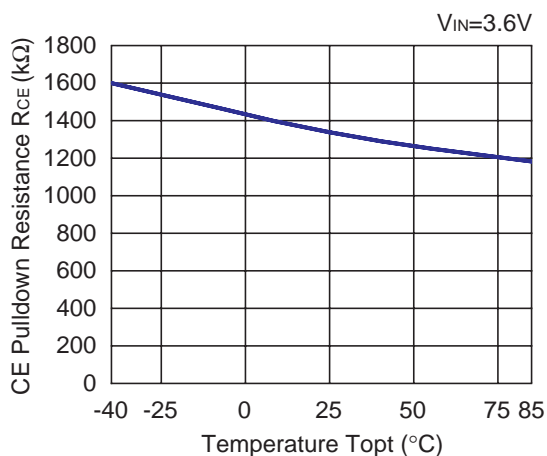

6) CE Input Voltage "L" vs. Temperature

R1200x

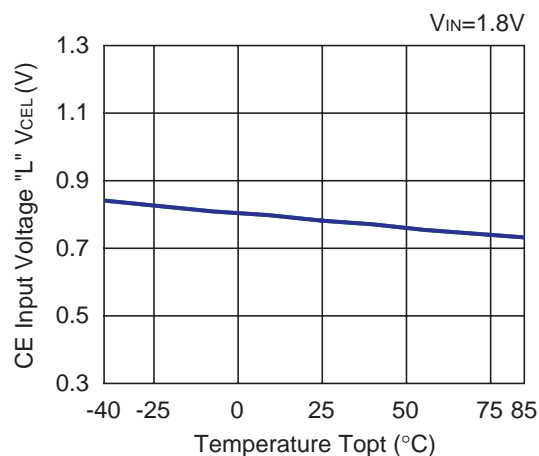

7) CE Input Voltage "H" vs. Temperature

R1200x

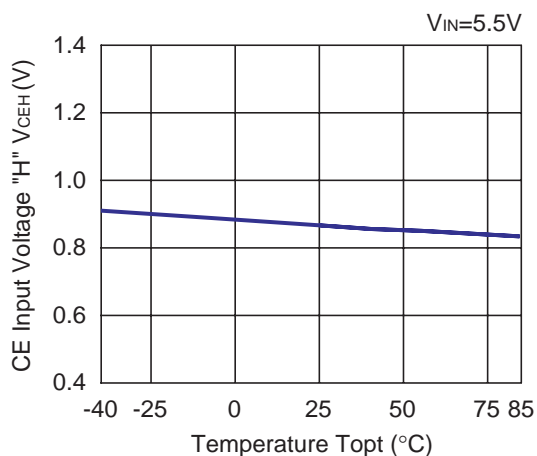

8) NPN  $V_{CE}$  Voltage vs. Temperature

R1200x

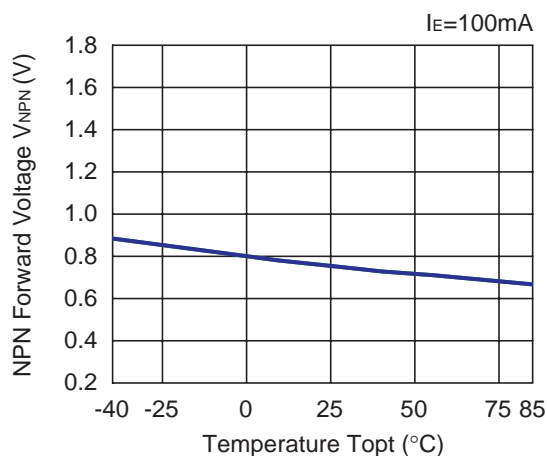

9)  $V_{FB}$  Voltage vs. Temperature

R1200x

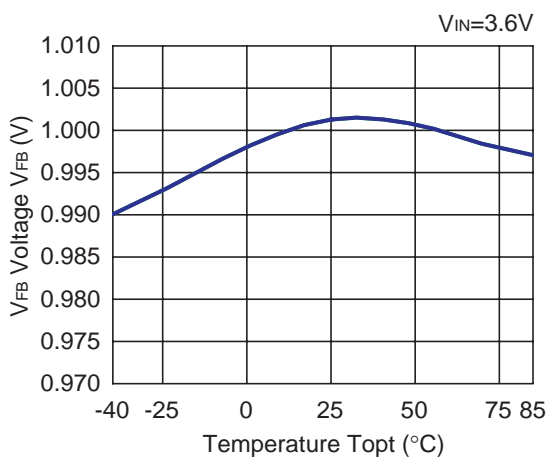

10) UVLO Detect / Released Voltage vs. Temperature

R1200x

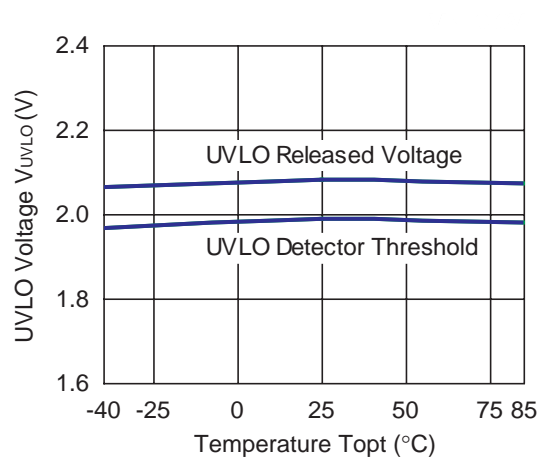

## R1200x

### 11) Oscillator Frequency vs. Temperature

R1200x

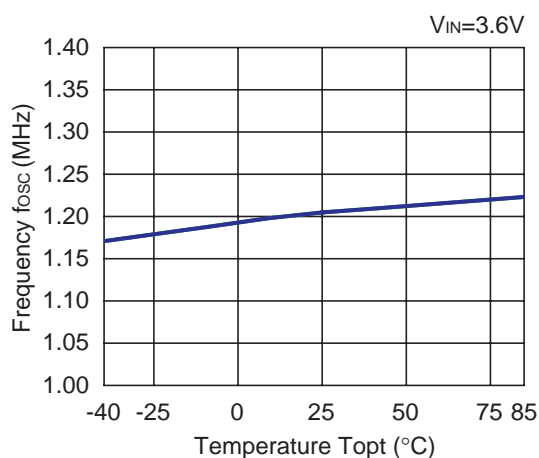

### 12) Maxduty vs. Temperature

R1200x

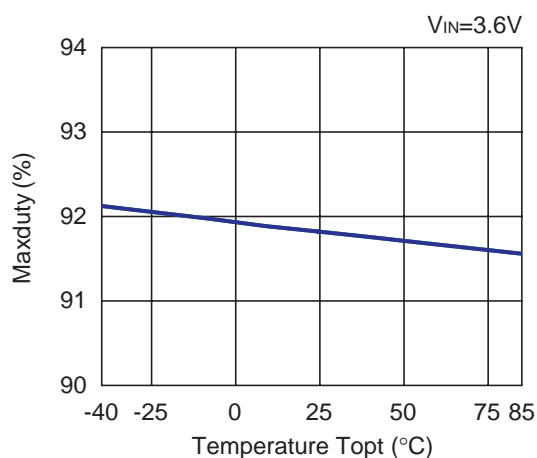

### 13) OVP Detect / Released Voltage vs. Temperature

R1200x001x

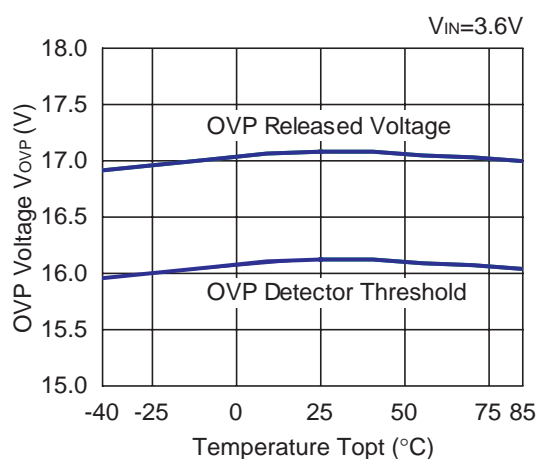

### 14) Soft-start Time vs. Temperature

R1200x

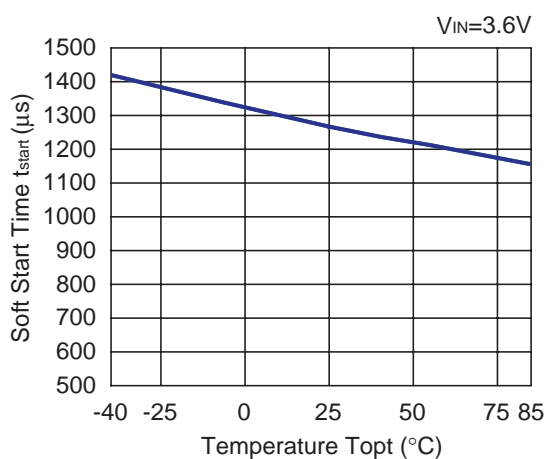

### 15) V<sub>OUT</sub> Discharge Current vs. Temperature

R1200x

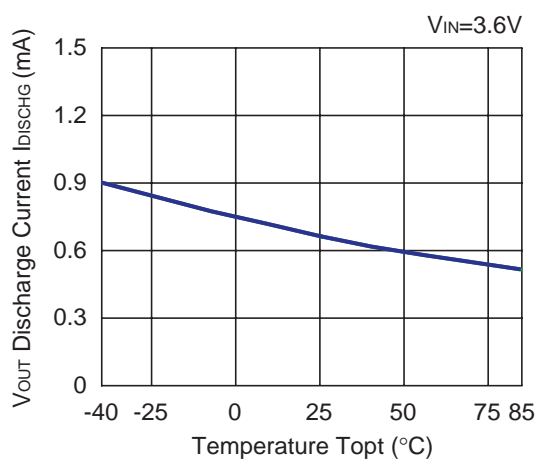

16) Lx Limit Current vs. Temperature  
R1200x

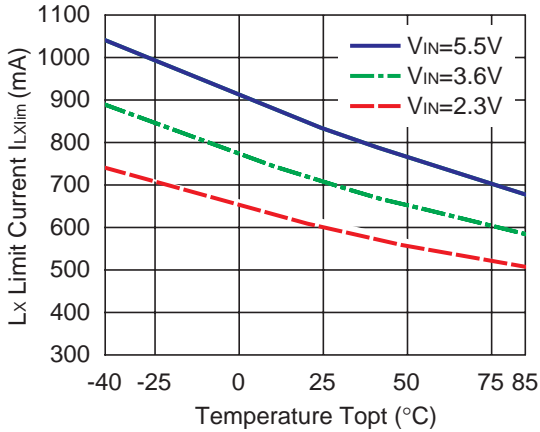

17) Switch ON Resistance vs. Temperature  
R1200x

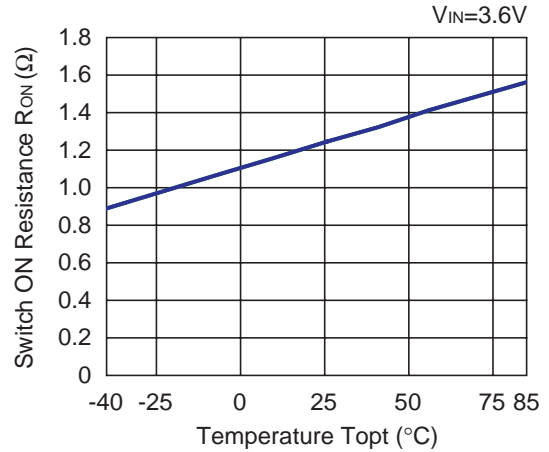

18) Load Transient Response (VIN=3.6V, IOUT=5mA↔25mA, tr=tf=0.5μs)  
R1200x

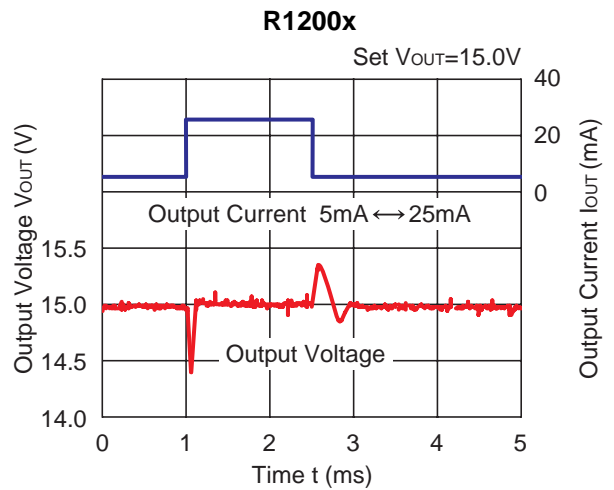
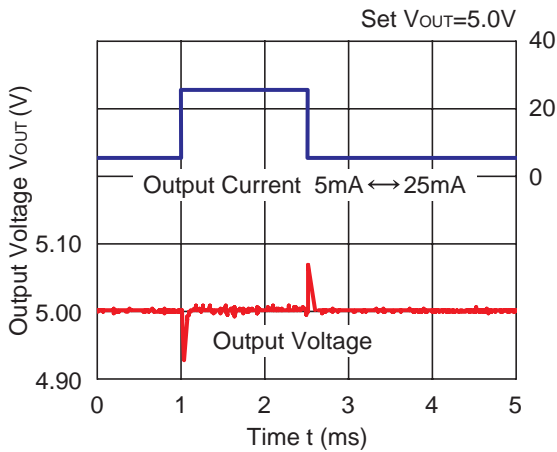

19) Start-up Waveform (VIN=3.6V, IOUT=20mA)  
R1200x001A

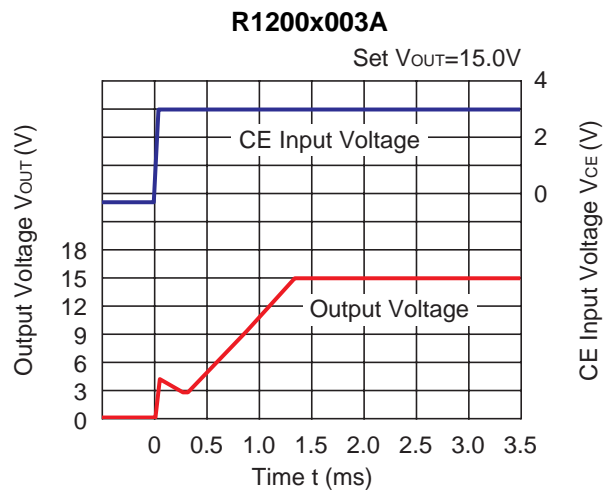
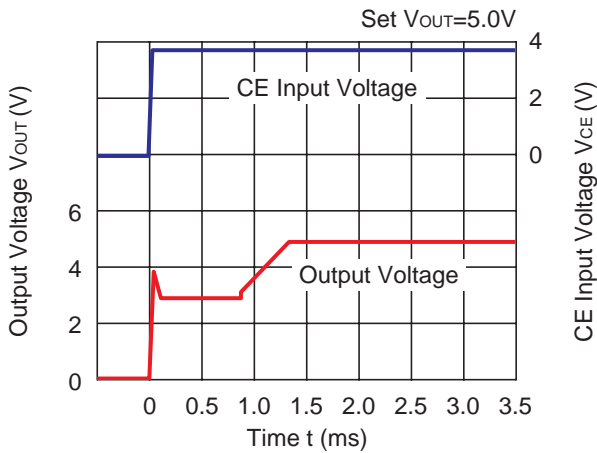

**R1200x**

**20) Shut-down Waveform ( $V_{IN}=3.6V$ ,  $I_{OUT}=20mA$ )**

**R1200x001A**

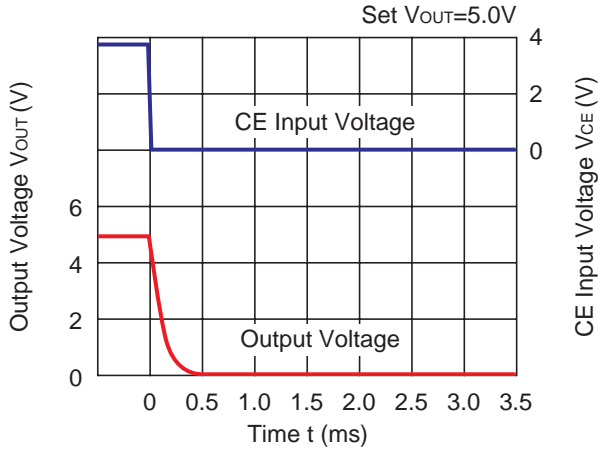

**R1200x003A**

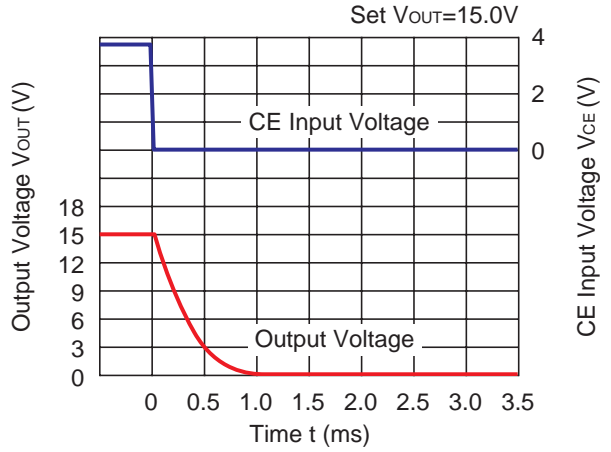

**21) OVP Waveform ( $V_{FB}=0V$ )**

**R1200x001A**

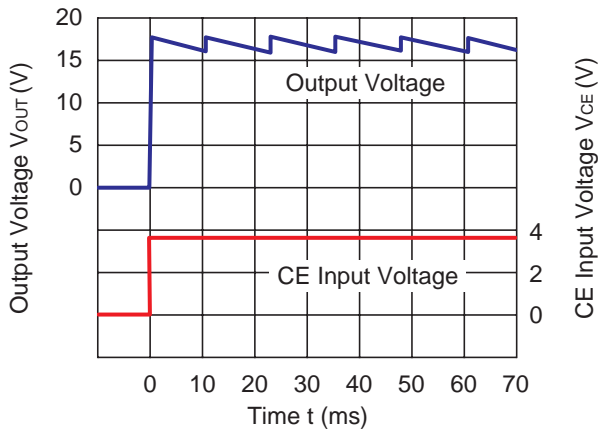





1. The products and the product specifications described in this document are subject to change or discontinuation of production without notice for reasons such as improvement. Therefore, before deciding to use the products, please refer to Ricoh sales representatives for the latest information thereon.
2. The materials in this document may not be copied or otherwise reproduced in whole or in part without prior written consent of Ricoh.
3. Please be sure to take any necessary formalities under relevant laws or regulations before exporting or otherwise taking out of your country the products or the technical information described herein.
4. The technical information described in this document shows typical characteristics of and example application circuits for the products. The release of such information is not to be construed as a warranty of or a grant of license under Ricoh's or any third party's intellectual property rights or any other rights.
5. The products listed in this document are intended and designed for use as general electronic components in standard applications (office equipment, telecommunication equipment, measuring instruments, consumer electronic products, amusement equipment etc.). Those customers intending to use a product in an application requiring extreme quality and reliability, for example, in a highly specific application where the failure or misoperation of the product could result in human injury or death (aircraft, spacevehicle, nuclear reactor control system, traffic control system, automotive and transportation equipment, combustion equipment, safety devices, life support system etc.) should first contact us.
6. We are making our continuous effort to improve the quality and reliability of our products, but semiconductor products are likely to fail with certain probability. In order to prevent any injury to persons or damages to property resulting from such failure, customers should be careful enough to incorporate safety measures in their design, such as redundancy feature, firecontainment feature and fail-safe feature. We do not assume any liability or responsibility for any loss or damage arising from misuse or inappropriate use of the products.
7. Anti-radiation design is not implemented in the products described in this document.
8. Please contact Ricoh sales representatives should you have any questions or comments concerning the products or the technical information.



**For the conservation of the global environment, Ricoh is advancing the decrease of the negative environmental impact material.**  
After Apr. 1, 2006, we will ship out the lead free products only. Thus, all products that will be shipped from now on comply with RoHS Directive.  
Basically after Apr. 1, 2012, we will ship out the Power Management ICs of the Halogen Free products only. (Ricoh Halogen Free products are also Antimony Free.)

## **RICOH** RICOH COMPANY, LTD. Electronic Devices Company

<http://www.ricoh.com/LSI/>

### **RICOH COMPANY, LTD.**

#### **Electronic Devices Company**

#### ● Higashi-Shinagawa Office (International Sales)

3-32-3, Higashi-Shinagawa, Shinagawa-ku, Tokyo 140-8655, Japan  
Phone: +81-3-5479-2857 Fax: +81-3-5479-0502

### **RICOH EUROPE (NETHERLANDS) B.V.**

#### ● Semiconductor Support Centre

"Nieuw Kronenburg" Prof. W.H. Keesomlaan 1, 1183 DJ, Amstelveen, The Netherlands  
P.O.Box 114, 1180 AC Amstelveen  
Phone: +31-20-5474-309 Fax: +31-20-5474-791

### **RICOH ELECTRONIC DEVICES KOREA Co., Ltd.**

11 floor, Haesung 1 building, 942, Daechidong, Gangnamgu, Seoul, Korea  
Phone: +82-2-2135-5700 Fax: +82-2-2135-5705

### **RICOH ELECTRONIC DEVICES SHANGHAI Co., Ltd.**

Room403, No.2 Building, 690#Bi Bo Road, Pu Dong New district, Shanghai 201203,  
People's Republic of China  
Phone: +86-21-5027-3200 Fax: +86-21-5027-3299

### **RICOH COMPANY, LTD.**

#### **Electronic Devices Company**

#### ● Taipei office

Room109, 10F-1, No.51, Hengyang Rd., Taipei City, Taiwan (R.O.C.)  
Phone: +886-2-2313-1621/1622 Fax: +886-2-2313-1623

# Mouser Electronics

Authorized Distributor

Click to View Pricing, Inventory, Delivery & Lifecycle Information:

[Ricoch Electronics:](#)

[R1200N003A-TR-FE](#) [R1200K003A-TR](#) [R1200N001A-TR-FE](#) [R1200N002A-TR-FE](#) [R1200K001A-TR](#)

Компания «Океан Электроники» предлагает заключение долгосрочных отношений при поставках импортных электронных компонентов на взаимовыгодных условиях!

Наши преимущества:

- Поставка оригинальных импортных электронных компонентов напрямую с производств Америки, Европы и Азии, а так же с крупнейших складов мира;
- Широкая линейка поставок активных и пассивных импортных электронных компонентов (более 30 млн. наименований);
- Поставка сложных, дефицитных, либо снятых с производства позиций;
- Оперативные сроки поставки под заказ (от 5 рабочих дней);
- Экспресс доставка в любую точку России;
- Помощь Конструкторского Отдела и консультации квалифицированных инженеров;
- Техническая поддержка проекта, помощь в подборе аналогов, поставка прототипов;
- Поставка электронных компонентов под контролем ВП;
- Система менеджмента качества сертифицирована по Международному стандарту ISO 9001;
- При необходимости вся продукция военного и аэрокосмического назначения проходит испытания и сертификацию в лаборатории (по согласованию с заказчиком);
- Поставка специализированных компонентов военного и аэрокосмического уровня качества (Xilinx, Altera, Analog Devices, Intersil, Interpoint, Microsemi, Actel, Aeroflex, Peregrine, VPT, Syfer, Eurofarad, Texas Instruments, MS Kennedy, Miteq, Cobham, E2V, MA-COM, Hittite, Mini-Circuits, General Dynamics и др.);

Компания «Океан Электроники» является официальным дистрибьютором и эксклюзивным представителем в России одного из крупнейших производителей разъемов военного и аэрокосмического назначения «JONHON», а так же официальным дистрибьютором и эксклюзивным представителем в России производителя высокотехнологичных и надежных решений для передачи СВЧ сигналов «FORSTAR».



## JONHON

«JONHON» (основан в 1970 г.)

Разъемы специального, военного и аэрокосмического назначения:

(Применяются в военной, авиационной, аэрокосмической, морской, железнодорожной, горно- и нефтедобывающей отраслях промышленности)

«FORSTAR» (основан в 1998 г.)

ВЧ соединители, коаксиальные кабели, кабельные сборки и микроволновые компоненты:

(Применяются в телекоммуникациях гражданского и специального назначения, в средствах связи, РЛС, а так же военной, авиационной и аэрокосмической отраслях промышленности).



Телефон: 8 (812) 309-75-97 (многоканальный)

Факс: 8 (812) 320-03-32

Электронная почта: [ocean@oceanchips.ru](mailto:ocean@oceanchips.ru)

Web: <http://oceanchips.ru/>

Адрес: 198099, г. Санкт-Петербург, ул. Калинина, д. 2, корп. 4, лит. А