

## MC Series - TO-92

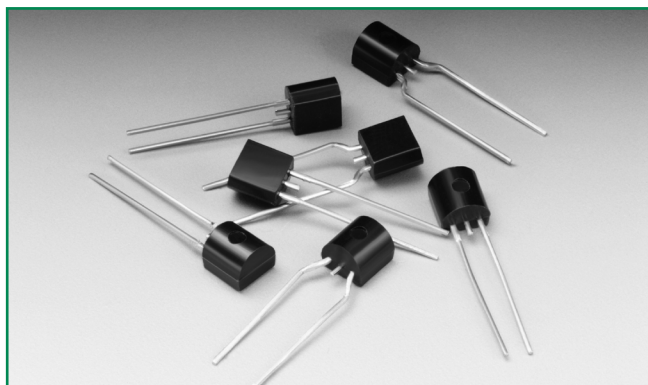

### Agency Approvals

Agency	Agency File Number
	E133083

### Pinout Designation

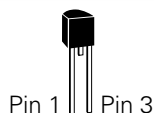

### Schematic Symbol



### Description

The MC Series TO-92 are low capacitance SIDACtor® thyristors designed to protect broadband CPE equipment such as VoIP and DSL Modems from damaging overvoltage transients.

The series provides a through-hole solution that enables CPE equipment to comply with global regulatory standards while limiting the impact to broadband signals.

### Features and Benefits

- Low voltage overshoot
- Low on-state voltage
- Does not degrade surge capability after multiple surge events within limit
- Fails short circuit when surged in excess of ratings
- RoHS Compliant
- 40% lower capacitance than our Baseband Protectors, for applications that demand greater signal integrity
- Pb-free E3 means 2nd level interconnect is Pb-free and the terminal finish material is tin (Sn) (IPC/JEDEC J-STD-609A.01)

### Applicable Global Standards

- TIA-968-A
- TIA-968-B
- ITU K.20/21/45 Enhanced Level
- ITU K.20/21/45 Basic Level
- GR 1089 Intra-building
- IEC 61000-4-5 2nd edition
- YD/T 1082
- YD/T 993
- YD/T 950
- GR 1089 Inter-building

### Electrical Characteristics

Part Number	Marking	$V_{DRM}$ @ $I_{DRM} = 5\mu A$	$V_S$ @ $100V/\mu s$	$I_H$	$I_S$	$I_T$	$V_T$ @ $I_T = 2.2$ Amps	Capacitance @ 1MHz, 2V bias	
		V min	V max	mA min	mA max	A max	V max	pF min	pF max
P0080ECMCLxxx	P0080ECMC	6	25	50	800	2.2	4	35	75
P0300ECMCLxxx	P0300ECMC	25	40	50	800	2.2	4	25	45
P0640ECMCLxxx	P0640ECMC	58	77	150	800	2.2	4	55	85
P0720ECMCLxxx	P0720ECMC	65	88	150	800	2.2	4	50	75
P0900ECMCLxxx	P0900ECMC	75	98	150	800	2.2	4	45	70
P1100ECMCLxxx	P1100ECMC	90	130	150	800	2.2	4	45	70
P1300ECMCLxxx	P1300ECMC	120	160	150	800	2.2	4	40	60
P1500ECMCLxxx	P1500ECMC	140	180	150	800	2.2	4	35	55
P1800ECMCLxxx	P1800ECMC	170	220	150	800	2.2	4	35	50
P2300ECMCLxxx	P2300ECMC	190	260	150	800	2.2	4	30	50
P2600ECMCLxxx	P2600ECMC	220	300	150	800	2.2	4	30	45
P3100ECMCLxxx	P3100ECMC	275	350	150	800	2.2	4	30	45
P3500ECMCLxxx	P3500ECMC	320	400	150	800	2.2	4	25	40

Notes:  
 - Absolute maximum ratings measured at  $T_A = 25^\circ C$  (unless otherwise noted).  
 - Components are bi-directional.  
 - **XXX** Part Number Suffix: 'AP' (Ammo Pack), or 'RP1' or 'RP2' (Reel Pack).

**Surge Ratings**

Series	$I_{PP}$									$I_{TSM}$ 50/60 Hz	di/dt
	0.2/310 <sup>1</sup>	2/10 <sup>1</sup>	8/20 <sup>1</sup>	10/160 <sup>1</sup>	10/560 <sup>1</sup>	5/320 <sup>1</sup>	10/360 <sup>1</sup>	10/1000 <sup>1</sup>	5/310 <sup>1</sup>		
	0.5/700 <sup>2</sup>	2/10 <sup>2</sup>	1.2/50 <sup>2</sup>	10/160 <sup>2</sup>	10/560 <sup>2</sup>	9/720 <sup>2</sup>	10/360 <sup>2</sup>	10/1000 <sup>2</sup>	10/700 <sup>2</sup>		
	A min	A min	A min	A min	A min	A min	A min	A min	A min	A min	A/μs Max
C	50	500	400	200	150	200	175	100	200	30	500

Notes:  
 1 Current waveform in μs  
 2 Voltage waveform in μs  
 - Peak pulse current rating ( $I_{pp}$ ) is repetitive and guaranteed for the life of the product that remains in thermal equilibrium.  
 -  $I_{pp}$  ratings applicable over temperature range of -40°C to +85°C  
 - The component must initially be in thermal equilibrium with -40°C ≤  $T_J$  ≤ +150°C

**Thermal Considerations**

Package	Symbol	Parameter	Value	Unit
 TO-92	$T_J$	Operating Junction Temperature Range	-40 to +150	°C
	$T_S$	Storage Temperature Range	-65 to +150	°C
	$R_{\theta JA}$	Thermal Resistance: Junction to Ambient	90	°C/W

**V-I Characteristics**

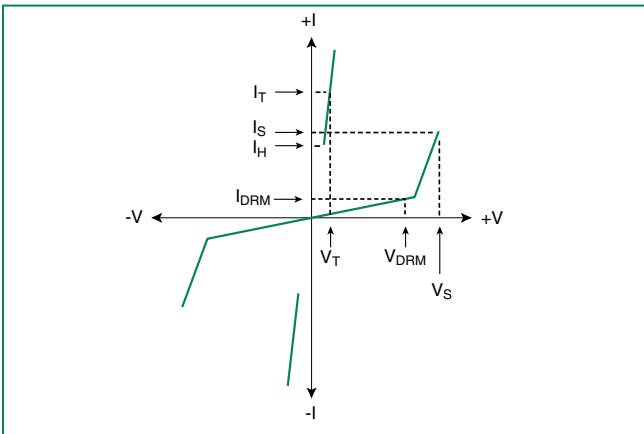

**$t_r \times t_d$  Pulse Waveform**

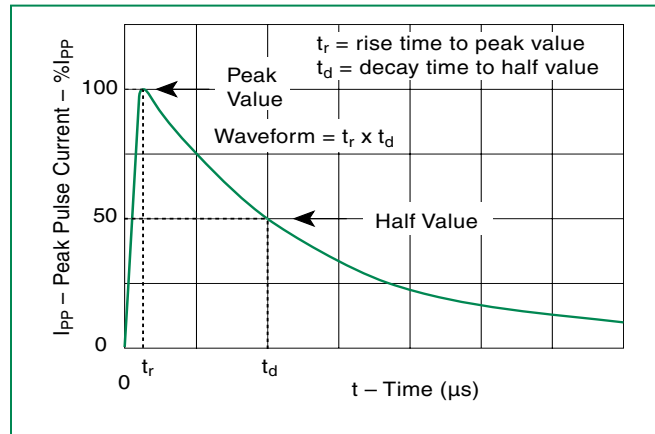

**Normalized  $V_S$  Change vs. Junction Temperature**

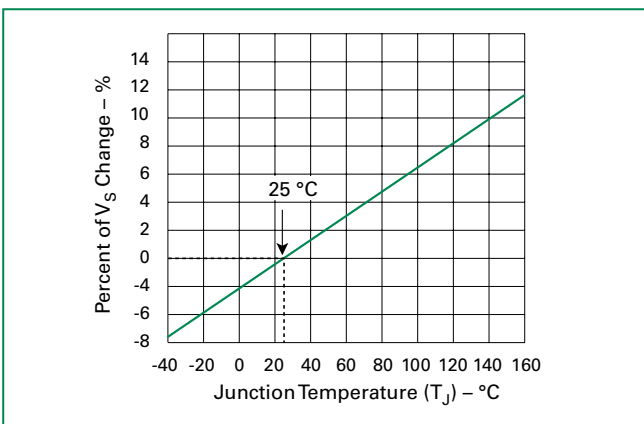

**Normalized DC Holding Current vs. Case Temperature**

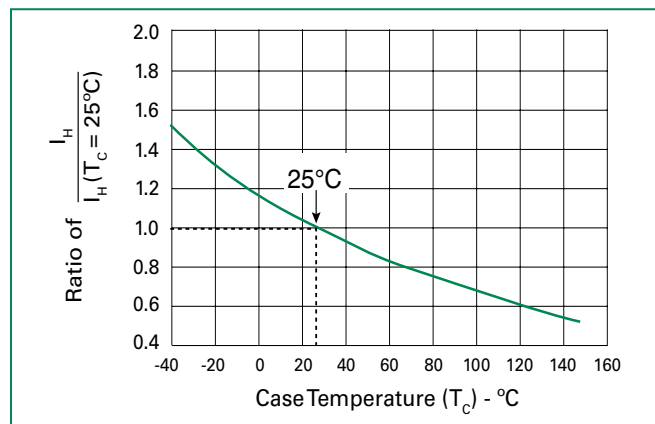

### Soldering Parameters

Reflow Condition		Pb-Free assembly (see Fig. 1)
Pre Heat	-Temperature Min ( $T_{s(min)}$ )	+150°C
	-Temperature Max ( $T_{s(max)}$ )	+200°C
	-Time (Min to Max) ( $t_s$ )	60-180 secs.
Average ramp up rate (LiquidusTemp ( $T_L$ ) to peak)		3°C/sec. Max.
$T_{s(max)}$ to $T_L$ - Ramp-up Rate		3°C/sec. Max.
Reflow	-Temperature ( $T_L$ ) (Liquidus)	+217°C
	-Temperature ( $t_L$ )	60-150 secs.
Peak Temp ( $T_p$ )		+260(+0/-5)°C
Time within 5°C of actual PeakTemp ( $t_p$ )		30 secs. Max.
Ramp-down Rate		6°C/sec. Max.
Time 25°C to Peak Temp ( $T_p$ )		8 min. Max.
Do not exceed		+260°C



### Physical Specifications

<b>Lead Material</b>	Copper Alloy
<b>Terminal Finish</b>	100% Matte-Tin Plated
<b>Body Material</b>	UL Recognized epoxy meeting flammability classification V-0

### Additional Information



Datasheet



Resources



Samples

### Environmental Specifications

<b>High Temp Voltage Blocking</b>	80% Rated $V_{DRM}$ ( $V_{AC}$ Peak) +125°C or +150°C, 504 or 1008 hrs. MIL-STD-750 (Method 1040) JEDEC, JESD22-A-101
<b>Temp Cycling</b>	-65°C to +150°C, 15 min. dwell, 10 up to 100 cycles. MIL-STD-750 (Method 1051) EIA/JEDEC, JESD22-A-104
<b>Biased Temp &amp; Humidity</b>	52 $V_{DC}$ (+85°C) 85%RH, 504 up to 1008 hrs. EIA/JEDEC, JESD22-A-101
<b>High Temp Storage</b>	+150°C 1008 hrs. MIL-STD-750 (Method 1031) JEDEC, JESD22-A-101
<b>Low Temp Storage</b>	-65°C, 1008 hrs.
<b>Thermal Shock</b>	0°C to +100°C, 5 min. dwell, 10 sec. transfer, 10 cycles. MIL-STD-750 (Method 1056) JEDEC, JESD22-A-106
<b>Autoclave (Pressure Cooker Test)</b>	+121°C, 100%RH, 2atm, 24 up to 168 hrs. EIA/JEDEC, JESD22-A-102
<b>Resistance to Solder Heat</b>	+260°C, 30 secs. MIL-STD-750 (Method 2031)
<b>Moisture Sensitivity Level</b>	85%RH, +85°C, 168 hrs., 3 reflow cycles (+260°C Peak). JEDEC-J-STD-020, Level 1

### Part Numbering

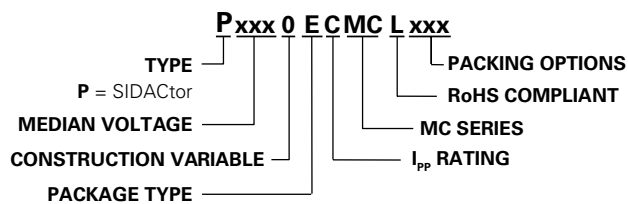

### Part Marking



**Packing Options**

Package Type	Description	Packing Options Quantity	Added Suffix	Lead Spacing	Industry Standard
E	TO-92 Tape and Reel Pack	2000	RP1	0.1 inch (2.54mm)	EIA-481-D
	TO-92 Ammo Pack		RP2	0.2 inch (5.08mm)	EIA-481-D
	TO-92 Bulk Pack		AP	(Not applicable)	EIA-468-B
			N/A	(Not applicable)	N/A

**Dimensions – TO-92**



	Inches		Millimeters	
	Min	Max	Min	Max
<b>A</b>	0.176	0.196	4.47	4.98
<b>B</b>	0.500		12.70	
<b>D</b>	0.095	0.105	2.41	2.67
<b>E</b>	0.150		3.81	
<b>G</b>	0.135	0.145	3.43	3.68
<b>H</b>	0.088	0.096	2.23	2.44
<b>J</b>	0.176	0.186	4.47	4.73
<b>K</b>	0.088	0.096	2.23	2.44
<b>L</b>	0.013	0.019	0.33	0.48
<b>M</b>	0.013	0.017	0.33	0.43
<b>N</b>		0.60		1.52

All leads are insulated from case. Case is electrically non-conductive. (Rated at 1600 V<sub>AC</sub> RMS for one minute from leads to case over the operating temperature range.)

Mold flash shall not exceed 0.13 mm per side.

The TO-92 is designed to meet mechanical standards as set forth in JEDEC publication number 95.

**Ammo Pack Specification – TO-92**



Dimensions are in inches (and millimeters).

**Tape and Reel Specification – TO-92**

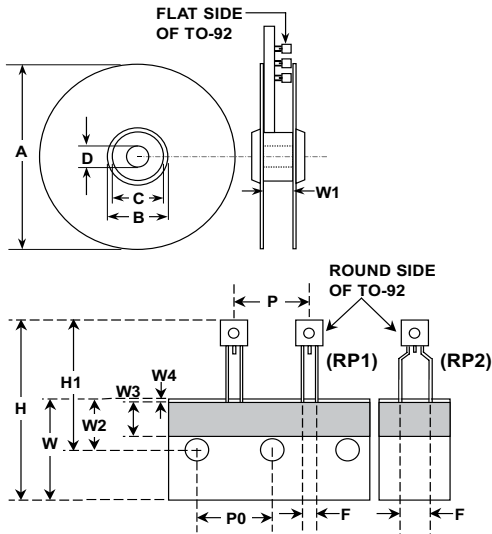

	Inches		Millimeters	
	Min	Max	Min	Max
<b>A</b>	N/A	14.173	N/A	360.0
<b>B</b>	4.016	N/A	102.0	N/A
<b>C</b>	3.386	N/A	86.0	N/A
<b>D</b>	0.795	N/A	20.2	N/A
<b>W1</b>	1.181	1.968	30.0	50.0
<b>P</b>	0.496	0.504	12.60	12.80
<b>P0</b>	0.498	0.502	12.65	12.75
<b>F(for RP1)</b>	0.090	0.110	2.29	2.80
<b>F(for RP2)</b>	0.182	0.244	4.63	6.19
<b>H</b>	N/A	1.673	N/A	42.50
<b>H1</b>	N/A	1.270	N/A	32.26
<b>W</b>	0.674	0.763	17.12	19.38
<b>W2</b>	0.354	0.370	8.25	9.75
<b>W3</b>	0.236	N/A	6.00	N/A
<b>W4</b>	0.020	N/A	0.50	N/A

**Disclaimer Notice - Information furnished is believed to be accurate and reliable. However, users should independently evaluate the suitability of and test each product selected for their own applications. Littelfuse products are not designed for, and may not be used in, all applications. Read complete Disclaimer Notice at [www.littelfuse.com/disclaimer-electronics](http://www.littelfuse.com/disclaimer-electronics).**

Компания «Океан Электроники» предлагает заключение долгосрочных отношений при поставках импортных электронных компонентов на взаимовыгодных условиях!

Наши преимущества:

- Поставка оригинальных импортных электронных компонентов напрямую с производств Америки, Европы и Азии, а так же с крупнейших складов мира;
- Широкая линейка поставок активных и пассивных импортных электронных компонентов (более 30 млн. наименований);
- Поставка сложных, дефицитных, либо снятых с производства позиций;
- Оперативные сроки поставки под заказ (от 5 рабочих дней);
- Экспресс доставка в любую точку России;
- Помощь Конструкторского Отдела и консультации квалифицированных инженеров;
- Техническая поддержка проекта, помощь в подборе аналогов, поставка прототипов;
- Поставка электронных компонентов под контролем ВП;
- Система менеджмента качества сертифицирована по Международному стандарту ISO 9001;
- При необходимости вся продукция военного и аэрокосмического назначения проходит испытания и сертификацию в лаборатории (по согласованию с заказчиком);
- Поставка специализированных компонентов военного и аэрокосмического уровня качества (Xilinx, Altera, Analog Devices, Intersil, Interpoint, Microsemi, Actel, Aeroflex, Peregrine, VPT, Syfer, Eurofarad, Texas Instruments, MS Kennedy, Miteq, Cobham, E2V, MA-COM, Hittite, Mini-Circuits, General Dynamics и др.);

Компания «Океан Электроники» является официальным дистрибьютором и эксклюзивным представителем в России одного из крупнейших производителей разъемов военного и аэрокосмического назначения «**JONHON**», а так же официальным дистрибьютором и эксклюзивным представителем в России производителя высокотехнологичных и надежных решений для передачи СВЧ сигналов «**FORSTAR**».



## JONHON

«**JONHON**» (основан в 1970 г.)

Разъемы специального, военного и аэрокосмического назначения:

(Применяются в военной, авиационной, аэрокосмической, морской, железнодорожной, горно- и нефтедобывающей отраслях промышленности)

«**FORSTAR**» (основан в 1998 г.)

ВЧ соединители, коаксиальные кабели,  
кабельные сборки и микроволновые компоненты:

(Применяются в телекоммуникациях гражданского и специального назначения, в средствах связи, РЛС, а так же военной, авиационной и аэрокосмической отраслях промышленности).



Телефон: 8 (812) 309-75-97 (многоканальный)

Факс: 8 (812) 320-03-32

Электронная почта: [ocean@oceanchips.ru](mailto:ocean@oceanchips.ru)

Web: <http://oceanchips.ru/>

Адрес: 198099, г. Санкт-Петербург, ул. Калинина, д. 2, корп. 4, лит. А