

Enclosed Switch D4MC

CSM_D4MC_DS_E_2_1

Economical, High Utility Enclosed Switch



- Enclosed Switches with Built-in Basic Switches for High Repeatability and Durability of 10 Million Operations Minimum.
- Panel mount versions have the same operating position as Z Basic Switch.
- Suitable for applications demanding higher mechanical strength, dustproof and drip-proof properties than those on basic switches.
- Resin molded terminal versions are available.
- Approved by UL, CSA, and CCC (Chinese standard). (Ask your OMRON representative for information on approved models.)



Be sure to read *Safety Precautions* on page 5 and *Safety Precautions for All Limit Switches*.

Model Number Structure

Model Number Legend

D4MC-
(1)

(1) Actuator

- 5000: Panel mount plunger
- 5020: Panel mount roller plunger
- 5040: Panel mount crossroller plunger
- 1000: Hinge lever
- 1020: Short hinge lever
- 2000: Hinge roller lever
- 2020: Short hinge roller lever
- 3030: One-way action short hinge roller lever

Ordering Information

Actuator	Model
Panel mount plunger	D4MC-5000
Panel mount roller plunger	D4MC-5020
Panel mount crossroller plunger	D4MC-5040
Hinge lever	D4MC-1000
Short hinge lever	D4MC-1020
Hinge roller lever	D4MC-2000
Short hinge roller lever	D4MC-2020
One-way action short hinge roller lever	D4MC-3030

Note: 1. Use Switches with molded terminals in locations subject to dirt, dust, oil drops, or high humidity. Models are available with lead wires on the right, on the left, and from the bottom.
2. Contact your OMRON representative for information on models certified for international standards.

Specifications

Approved Standards

Agency	Standard	File No.
UL *	UL508, CSA C22.2 No.14	E76675
CCC(CQC)	GB14048.5	2003010303077627

Note: Ask your OMRON representative for information on approved models.
* UL certified for CSA C22.2 No. 14.

Ratings

Rated voltage	Non-inductive load (A)				Inductive load (A)			
	Resistive load		Lamp load		Inductive load		Motor load	
	NC	NO	NC	NO	NC	NO	NC	NO
125 VAC	10	3	1.5	1.5	10	5	5	2.5
250 VAC	10	2.5	1.25	0.75	10	3	3	1.5
480 VAC	3	1.5	0.75	0.25	2.5	1.5	0.75	0.75
8 VDC	10	3	1.5	0.2	6	5	5	2.5
14 VDC	10	3	1.5	0.2	6	5	5	2.5
30 VDC	6	3	1.5	0.2	5	5	5	2.5
125 VDC	0.5	0.4	0.4	0.03	0.05	0.05	0.05	0.05
250 VDC	0.25	0.2	0.2	0.03	0.03	0.03	0.03	0.03

Inrush current	NC	30 A max.
	NO	15 A max.

- Note: 1. The above figures are for steady-state currents.
 2. Inductive loads have a power factor of 0.4 min. (AC) and a time constant of 7 ms max. (DC).
 3. Lamp load has an inrush current of 10 times the steady-state current.
 4. Motor load has an inrush current of 6 times the steady-state current.
 5. The above ratings were tested under the following conditions.
 (1) Ambient temperature: +20±2°C
 (2) Ambient humidity: 65±5%RH
 (3) Operating frequency: 20 operations/min

Characteristics

Degree of protection	IP67	
Durability	Mechanical	10,000,000 operations min.
	Electrical	500,000 operations min.
Operating speed	0.05 mm/s to 0.5 m/s *1	
Operating frequency	Mechanical	120 operations/min
	Electrical	20 operations/min
Rated frequency	50/60 Hz	
Insulation resistance	100 MΩ min. (at 500 VDC)	
Contact resistance	15 mΩ max. (initial value for the built-in switch when tested alone)	
Dielectric strength	Between terminals of the same polarity	1,000 VAC, 50/60 Hz for 1 min
	Between each terminal and non-current-carrying part	2,000 VAC, 50/60 Hz for 1 min
Rated insulation voltage (Ui)	1,000 VAC	
Pollution degree (operating environment)	3 (IEC947-5-1)	
Protection against electric shock	Class II	
PTI (tracking characteristics)	175	
Switch category	D (IEC335)	
Rated operating current (Ie)	10 A	
Rated operating voltage (Ue)	250 VAC	
Vibration resistance	Malfunction	10 to 55 Hz, 1.5-mm double amplitude *2
Shock resistance	Destruction	1,000 m/s ² min.
	Malfunction	100 m/s ² min. *1 *2
Ambient operating temperature	-10°C to +80°C (with no icing)	
Ambient operating humidity	35% to 95%RH	
Weight	Approx. 71 g (in case of panel mount plunger)	

*1. Only for models with plungers. (Contact your OMRON representative for information on other models.)

*2. Less than 1 ms under a free state at the operating limits.

Structure and Nomenclature

Structure

Changing the Terminal Protective Cover around allows the cable to be pulled out from either the right or the left.

M4 binding head screws (with toothed washers) are used as the terminal screws.



Contact Form



Approved Standard Ratings

UL/CSA

A300

Rated voltage	Carry current	Current (A)		Volt-amperes (VA)	
		Make	Break	Make	Break
120 VAC	10A	60	6	7,200	720
240 VAC		30	3		

EN60947-5-1

CCC (GB14048.5)

Applicable category and ratings
AC-12 10 A/250 VAC

Engineering Data

Electrical Durability

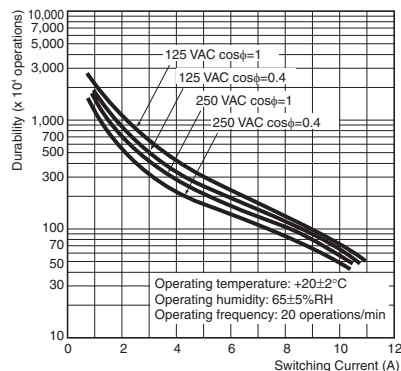

Mechanical Durability (D4MC-5000)



Dimensions and Operating Characteristics

Panel Mount Plunger D4MC-5000



- *1. Stainless steel plunger
- *2. The length of the imperfect threads is 1.5 mm maximum.
- *3. Thickness: 3 width: 17

Note: Do not use the M12 mounting screw and the case mounting hole at the same time.

Panel Mount Roller Plunger D4MC-5020

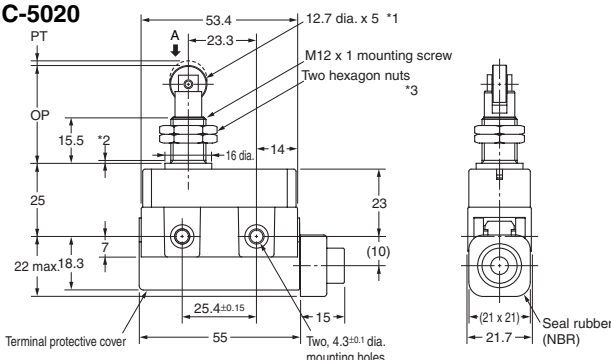

- *1. Stainless steel plunger
- *2. The length of the imperfect threads is 1.5 mm maximum.
- *3. Thickness: 3 width: 17

Note: Do not use the M12 mounting screw and the case mounting hole at the same time.

Panel Mount Crossroller Plunger D4MC-5040

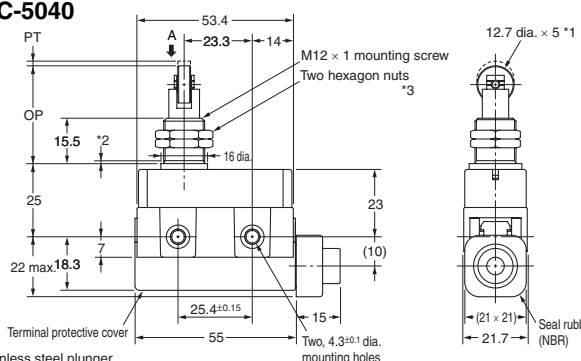

- *1. Stainless steel plunger
- *2. The length of the imperfect threads is 1.5 mm maximum.
- *3. Thickness: 3 width: 17

Note: Do not use the M12 mounting screw and the case mounting hole at the same time.

Hinge Lever D4MC-1000

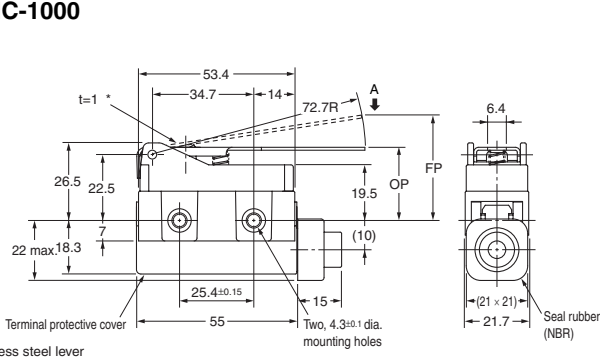

- * Stainless steel lever

Short Hinge Lever D4MC-1020

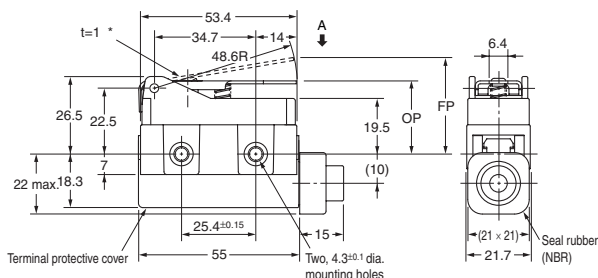

- * Stainless steel lever

Hinge Roller Lever D4MC-2000

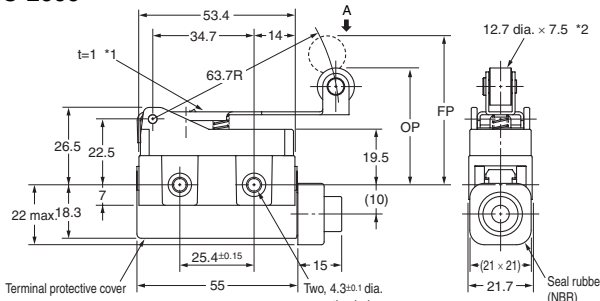

- *1. Stainless steel lever
- *2. Plastic roller

- Note: 1. Unless otherwise specified, a tolerance of ± 0.4 mm applies to all dimensions.
 2. Operating characteristics are for when the Switch is operated from direction A.
 3. Make sure that the permissible OT position is not exceeded.

Operating Characteristics	Model	D4MC-5000	D4MC-5020	D4MC-5040	D4MC-1000	D4MC-1020	D4MC-2000
Operating force	OF max.	5.88 N	5.88 N	5.88 N	1.67 N	2.55 N	1.96 N
Release force	RF min.	0.98 N	0.98 N	0.98 N	0.25 N	0.34 N	0.39 N
Pretravel	PT max.	1.6 mm	1.6 mm	1.6 mm	---	---	---
Overtravel	OT min.	5 mm	5 mm	5 mm	4 mm	2.5 mm	5 mm
Movement Differential	MD max.	0.2 mm	0.2 mm	0.2 mm	3 mm	1.7 mm	3 mm
Free Position	FP max.	---	---	---	36 mm	33 mm	51 mm
Operating Position	OP	21.8 \pm 1.2 mm	33.4 \pm 1.2 mm	33.4 \pm 1.2 mm	25 \pm 1 mm	25 \pm 1 mm	40 \pm 1 mm

Short Hinge Roller Lever D4MC-2020

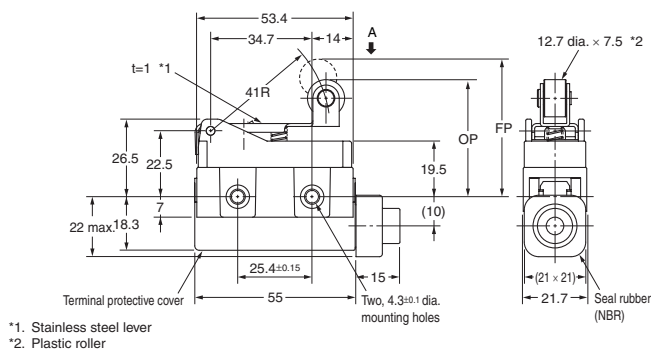

One-way Action Short Hinge Roller Lever D4MC-3030

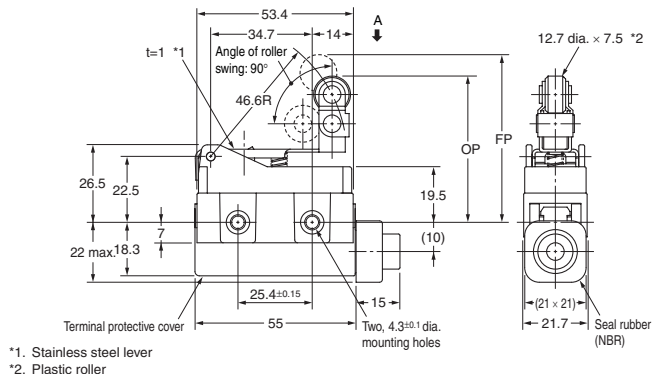

- Note: 1. Unless otherwise specified, a tolerance of ± 0.4 mm applies to all dimensions.
 2. Operating characteristics are for when the Switch is operated from direction A.
 3. Make sure that the permissible OT position is not exceeded.

Operating characteristics	Model	D4MC-2020	D4MC-3030
Operating force	OF max.	2.94 N	2.94 N
Release force	RF min.	0.39 N	0.39 N
Pretravel	PT max.	---	---
Overtravel	OT min.	2 mm	2 mm
Movement Differential	MD max.	1.5 mm	1.5 mm
Free Position	FP max.	47 mm	57.2 mm
Operating position	OP	40 ± 1 mm	50 ± 1 mm

Molded Terminal Models (Not Approved by UL, CSA, or EN)

Use Switches with molded terminals in locations subject to dirt, dust, oil drops, or high humidity. Molded terminals are available with all D4MC models. Dimensions and operating characteristics are the same as the basic models.



Suffix by Location of Lead Outlet

Location of lead outlet (Refer to left figure)	Model
	COM, NC, and NO
(1) Right-hand	D4MC-□□□1
(2) Left-hand	D4MC-□□□2
(3) Underside	D4MC-□□□3

Note: To form the model numbers for molded terminals models, add the numbers 1 to 3 in the table above to the end of the model number in Ordering Information on page 1.

Leads Supplied

Specifications	Nominal cross-sectional area mm ²	External diameter mm	Terminal connections	Cable length m
Leads				
V.C.T. (Vinyl cabtire cable)	1.25	3 conductor 10.5 dia.	Black: COM White: NO Red: NC	1, 3

Note: Add the VCT length to the end of the model number when ordering. Consult with your OMRON representative for other types of lead wires and for lead wires longer than 3 m.

How to Order

Example:
 Standard type: D4MC-5020
 Location of lead outlet: Underside
 Length of lead: 1 m (V.C.T. lead)
 When placing your order for the above Switch specify the model number as D4MC-5023 VCT 1M

Terminal Protective Cover, Seal Rubber, and Rubber Packing (The Switch is equipped with these 3 items as a standard.)

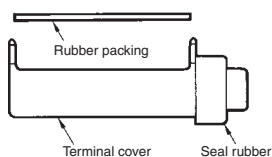

- ZC Terminal Cover (Product code: ZC55-0002H)
- ZC Seal Rubber (Product code: SC-1404C)
- ZC Rubber Packing (Product code: ZC55-0003F)

Safety Precautions

Refer to *Safety Precautions for All Limit Switches*.

Precautions for Use

Operating Environment

- Seal material may deteriorate if a Switch is used outdoor or where subject to special cutting oils, solvents, or chemicals. Always appraise performance under actual application conditions and set suitable maintenance and replacement periods.
- Install Switches where they will not be directly subject to cutting chips, dust, or dirt. The Actuator and Switch must also be protected from the accumulation of cutting chips or sludge.



- Constantly subjecting a Switch to vibration or shock can result in wear, which can lead to contact interference with contacts, operation failure, reduced durability, and other problems. Excessive vibration or shock can lead to false contact operation or damage. Install Switches in locations not subject to shock and vibration and in orientations that will not produce resonance.
- The Switches have physical contacts. Using them in environments containing silicon gas will result in the formation of silicon oxide (SiO₂) due to arc energy. If silicon oxide accumulates on the contacts, contact interference can occur. If silicon oil, silicon filling agents, silicon cables, or other silicon products are present near the Switch, suppress arcing with contact protective circuits (surge killers) or remove the source of silicon gas.

Operating

Excessive dog angle, operating speed, or overtravel (OT) may damage the actuator. Check that OT has a sufficient margin. The actual OT should be rated OT × 0.7 to 1.

Handling

- Do not expose the Switch to water exceeding +60°C or use it in steam.
- Do not use the Switch in oil or water.
- An 8.5-dia. to 10.5-dia. cable can be applied as seal rubber for the lead wire outlet. (Use two- or three-core cable of VCT1.25 mm².)
- When detaching the Terminal Protective Cover, insert a screwdriver and apply a force in the opening direction. Do not use excess force to remove the cover. Doing so may cause deformation in the fitting section and reduce the holding force.



- When mounting the Terminal Protective Cover to the case, align the cover on the case and then press the cover down to mount it firmly. If the cover is pressed down in an inclined position, rubber packing will deform and thus affect the sealing capability.



Mounting

- When mounting the Switch with screws on a side surface, fasten the Switch with M4 screws and use washers, spring washers, etc., to ensure secure mounting.

Mounting Holes

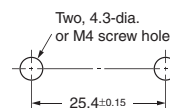

- When mounting the Panel Mount-type Switch (D4MC-5000, D4MC-5020, or D4MC-5040) with screws on a side surface, remove the hexagonal nuts from the actuator.
- When mounting the panel mount type on a panel, be careful not to tighten to an excessive torque. Tightening the screws to a torque exceeding 4.91 N-m will cause the plunger to fail.

Mounting Hole Dimensions

D4MC-5000

D4MC-5020, D4MC-5040

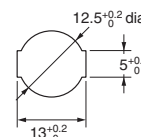

Tightening Torque

A loose screw may cause malfunctions. Be sure to tighten each screw to the proper tightening torque as shown in the table.

No.	Type	Appropriate tightening torque
(1)	Terminal screw	0.78 to 1.18 N-m
(2)	Panel mounting screw	2.94 to 4.92 N-m
(3)	Side mounting screw	1.18 to 1.47 N-m

Read and Understand This Catalog

Please read and understand this catalog before purchasing the products. Please consult your OMRON representative if you have any questions or comments.

Warranty and Limitations of Liability

WARRANTY

OMRON's exclusive warranty is that the products are free from defects in materials and workmanship for a period of one year (or other period if specified) from date of sale by OMRON.

OMRON MAKES NO WARRANTY OR REPRESENTATION, EXPRESS OR IMPLIED, REGARDING NON-INFRINGEMENT, MERCHANTABILITY, OR FITNESS FOR PARTICULAR PURPOSE OF THE PRODUCTS. ANY BUYER OR USER ACKNOWLEDGES THAT THE BUYER OR USER ALONE HAS DETERMINED THAT THE PRODUCTS WILL SUITABLY MEET THE REQUIREMENTS OF THEIR INTENDED USE. OMRON DISCLAIMS ALL OTHER WARRANTIES, EXPRESS OR IMPLIED.

LIMITATIONS OF LIABILITY

OMRON SHALL NOT BE RESPONSIBLE FOR SPECIAL, INDIRECT, OR CONSEQUENTIAL DAMAGES, LOSS OF PROFITS OR COMMERCIAL LOSS IN ANY WAY CONNECTED WITH THE PRODUCTS, WHETHER SUCH CLAIM IS BASED ON CONTRACT, WARRANTY, NEGLIGENCE, OR STRICT LIABILITY.

In no event shall the responsibility of OMRON for any act exceed the individual price of the product on which liability is asserted.

IN NO EVENT SHALL OMRON BE RESPONSIBLE FOR WARRANTY, REPAIR, OR OTHER CLAIMS REGARDING THE PRODUCTS UNLESS OMRON'S ANALYSIS CONFIRMS THAT THE PRODUCTS WERE PROPERLY HANDLED, STORED, INSTALLED, AND MAINTAINED AND NOT SUBJECT TO CONTAMINATION, ABUSE, MISUSE, OR INAPPROPRIATE MODIFICATION OR REPAIR.

Application Considerations

SUITABILITY FOR USE

OMRON shall not be responsible for conformity with any standards, codes, or regulations that apply to the combination of products in the customer's application or use of the products.

At the customer's request, OMRON will provide applicable third party certification documents identifying ratings and limitations of use that apply to the products. This information by itself is not sufficient for a complete determination of the suitability of the products in combination with the end product, machine, system, or other application or use.

The following are some examples of applications for which particular attention must be given. This is not intended to be an exhaustive list of all possible uses of the products, nor is it intended to imply that the uses listed may be suitable for the products:

- Outdoor use, uses involving potential chemical contamination or electrical interference, or conditions or uses not described in this catalog.
- Nuclear energy control systems, combustion systems, railroad systems, aviation systems, medical equipment, amusement machines, vehicles, safety equipment, and installations subject to separate industry or government regulations.
- Systems, machines, and equipment that could present a risk to life or property.

Please know and observe all prohibitions of use applicable to the products.

NEVER USE THE PRODUCTS FOR AN APPLICATION INVOLVING SERIOUS RISK TO LIFE OR PROPERTY WITHOUT ENSURING THAT THE SYSTEM AS A WHOLE HAS BEEN DESIGNED TO ADDRESS THE RISKS, AND THAT THE OMRON PRODUCTS ARE PROPERLY RATED AND INSTALLED FOR THE INTENDED USE WITHIN THE OVERALL EQUIPMENT OR SYSTEM.

PROGRAMMABLE PRODUCTS

OMRON shall not be responsible for the user's programming of a programmable product, or any consequence thereof.

Disclaimers

CHANGE IN SPECIFICATIONS

Product specifications and accessories may be changed at any time based on improvements and other reasons.

It is our practice to change model numbers when published ratings or features are changed, or when significant construction changes are made. However, some specifications of the products may be changed without any notice. When in doubt, special model numbers may be assigned to fix or establish key specifications for your application on your request. Please consult with your OMRON representative at any time to confirm actual specifications of purchased products.

DIMENSIONS AND WEIGHTS

Dimensions and weights are nominal and are not to be used for manufacturing purposes, even when tolerances are shown.

PERFORMANCE DATA

Performance data given in this catalog is provided as a guide for the user in determining suitability and does not constitute a warranty. It may represent the result of OMRON's test conditions, and the users must correlate it to actual application requirements. Actual performance is subject to the OMRON Warranty and Limitations of Liability.

ERRORS AND OMISSIONS

The information in this document has been carefully checked and is believed to be accurate; however, no responsibility is assumed for clerical, typographical, or proofreading errors, or omissions.

2008.11

In the interest of product improvement, specifications are subject to change without notice.

OMRON Corporation
Industrial Automation Company

<http://www.ia.omron.com/>

(c)Copyright OMRON Corporation 2008 All Right Reserved.

Компания «Океан Электроники» предлагает заключение долгосрочных отношений при поставках импортных электронных компонентов на взаимовыгодных условиях!

Наши преимущества:

- Поставка оригинальных импортных электронных компонентов напрямую с производств Америки, Европы и Азии, а так же с крупнейших складов мира;
- Широкая линейка поставок активных и пассивных импортных электронных компонентов (более 30 млн. наименований);
- Поставка сложных, дефицитных, либо снятых с производства позиций;
- Оперативные сроки поставки под заказ (от 5 рабочих дней);
- Экспресс доставка в любую точку России;
- Помощь Конструкторского Отдела и консультации квалифицированных инженеров;
- Техническая поддержка проекта, помощь в подборе аналогов, поставка прототипов;
- Поставка электронных компонентов под контролем ВП;
- Система менеджмента качества сертифицирована по Международному стандарту ISO 9001;
- При необходимости вся продукция военного и аэрокосмического назначения проходит испытания и сертификацию в лаборатории (по согласованию с заказчиком);
- Поставка специализированных компонентов военного и аэрокосмического уровня качества (Xilinx, Altera, Analog Devices, Intersil, Interpoint, Microsemi, Actel, Aeroflex, Peregrine, VPT, Syfer, Eurofarad, Texas Instruments, MS Kennedy, Miteq, Cobham, E2V, MA-COM, Hittite, Mini-Circuits, General Dynamics и др.);

Компания «Океан Электроники» является официальным дистрибьютором и эксклюзивным представителем в России одного из крупнейших производителей разъемов военного и аэрокосмического назначения «JONHON», а так же официальным дистрибьютором и эксклюзивным представителем в России производителя высокотехнологичных и надежных решений для передачи СВЧ сигналов «FORSTAR».



JONHON

«JONHON» (основан в 1970 г.)

Разъемы специального, военного и аэрокосмического назначения:

(Применяются в военной, авиационной, аэрокосмической, морской, железнодорожной, горно- и нефтедобывающей отраслях промышленности)

«FORSTAR» (основан в 1998 г.)

ВЧ соединители, коаксиальные кабели,
кабельные сборки и микроволновые компоненты:

(Применяются в телекоммуникациях гражданского и специального назначения, в средствах связи, РЛС, а так же военной, авиационной и аэрокосмической отраслях промышленности).



Телефон: 8 (812) 309-75-97 (многоканальный)

Факс: 8 (812) 320-03-32

Электронная почта: ocean@oceanchips.ru

Web: <http://oceanchips.ru/>

Адрес: 198099, г. Санкт-Петербург, ул. Калинина, д. 2, корп. 4, лит. А