



## GaAs MMIC DOUBLE-BALANCED MIXER, 2 - 18 GHz

### Typical Application

The HMC1048LC3B is ideal for:

- Ka-band Transponders
- Point-to-Multi-Point Radios & VSAT
- Test Equipment & Sensors
- Military End-Use

### Features

Passive: No DC Bias Required

High Input IP3: 23 dBm

LO/RF Isolation: 38 dB

LO/IF Isolation: 28 dB

RF/IF Isolation: 15 dB

IF Bandwidth: DC - 4 GHz

Downconverter Applications

12 Lead Ceramic 3x3 mm SMT Package: 9 mm<sup>2</sup>

### Functional Diagram

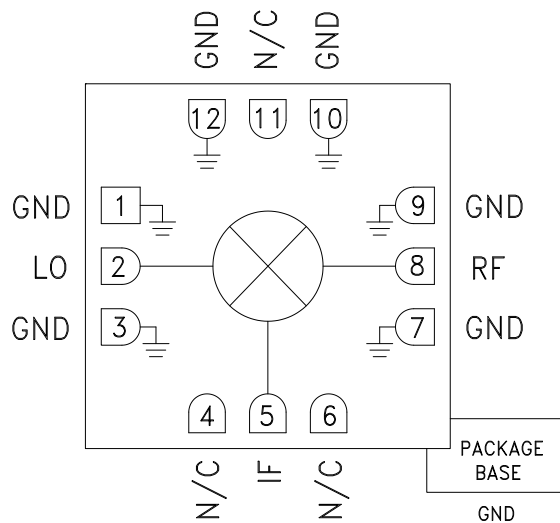

### General Description

The HMC1048LC3B is a general purpose double balanced mixer that can be used as a downconverter with DC to 4 GHz at the IF port and 2 to 18 GHz at the RF port. This mixer requires no external components or matching circuitry. The HMC1048LC3B provides excellent LO/RF, LO/IF and RF/IF isolation. The mixer operates with LO drive levels from +9 dBm to +17 dBm. The HMC1048LC3B eliminates the need for wire bonding and allows the use of surface mount manufacturing techniques.

### Electrical Specifications, $T_A = +25\text{ }^\circ\text{C}$ , Downconverter, $IF = 100\text{ MHz}$ , $LO = +13\text{ dBm}$ <sup>[1]</sup>

Parameter	Min.	Typ.	Max.	Min.	Typ.	Max.	Units
Frequency Range, RF & LO	2 - 12		12 - 18				GHz
Frequency Range, IF	DC - 4		DC - 4				GHz
Conversion Loss		9	12		11	13	dB
LO to RF Isolation <sup>[2]</sup>	28	38		28	35		dB
LO to IF Isolation <sup>[2]</sup>	15	20		18	28		dB
RF to IF Isolation	8	15		8	12		dB
IP3 (Input)		20			23		dBm
1 dB Gain Compression (Input)		10			13		dBm

[1] Unless otherwise noted all measurements performed as an Downconverter.

[2] Fixed IF = 100 MHz.

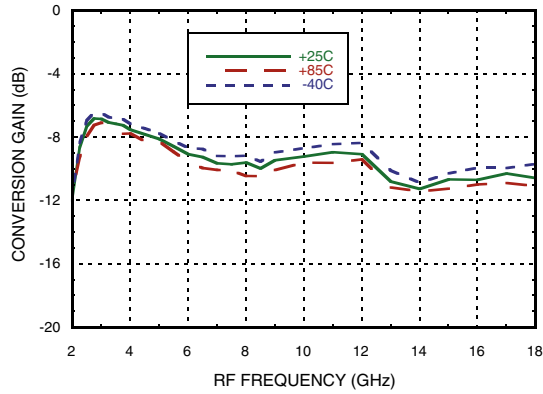
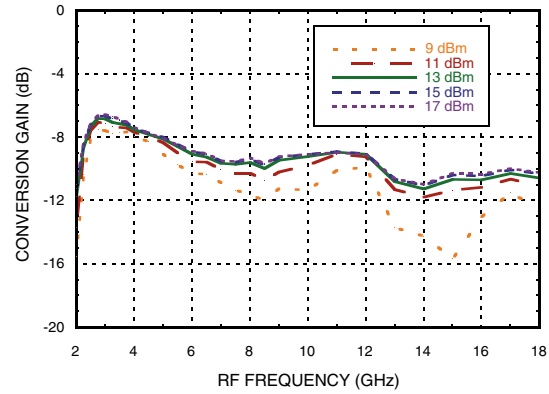
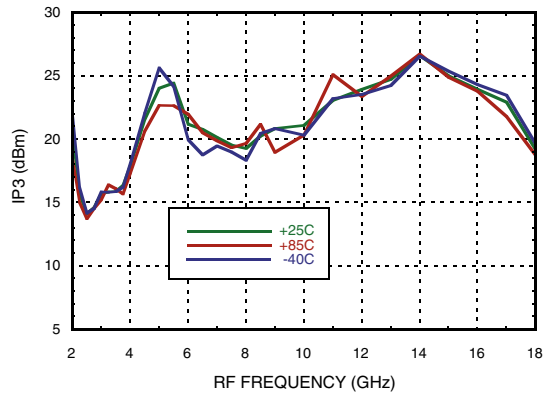
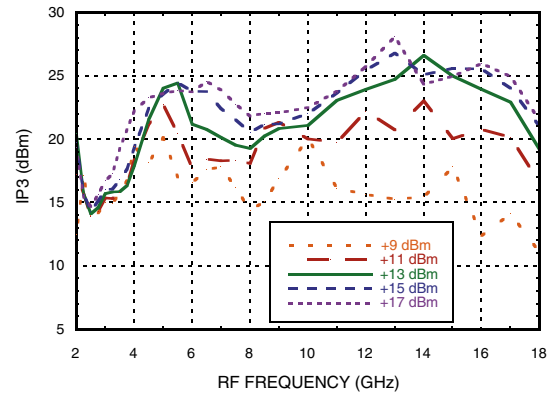
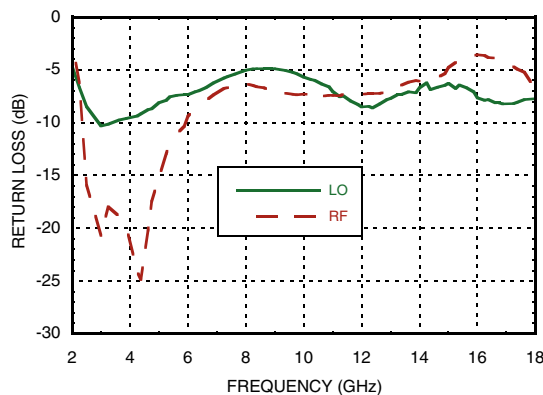
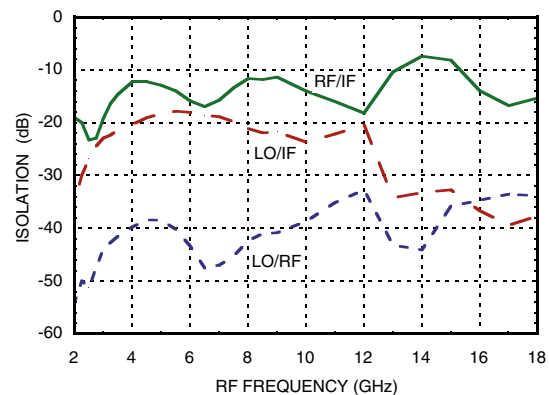

**GaAs MMIC DOUBLE-BALANCED  
MIXER, 2 - 18 GHz**
**Conversion Gain vs. Temperature,  
IF= 100 MHz, LO= 13dBm**

**Conversion Gain vs. LO Power,  
IF= 100 MHz**

**Input IP3 vs. Temperature,  
IF= 100 MHz, LO= 13dBm**

**Input IP3 vs. LO Power,  
IF= 100 MHz**

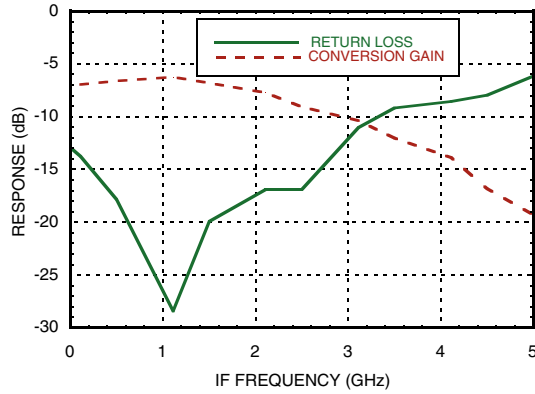
**RF and LO Return Loss**

**Isolation**



## GaAs MMIC DOUBLE-BALANCED MIXER, 2 - 18 GHz

MIXER - DOUBLE-BALANCED - SMT

**IF Bandwidth @ LO= 13 dBm,  
LO = 2.4 GHz**



**Input P1dB vs. Temperature  
IF=100 MHz, LO= 13dBm**

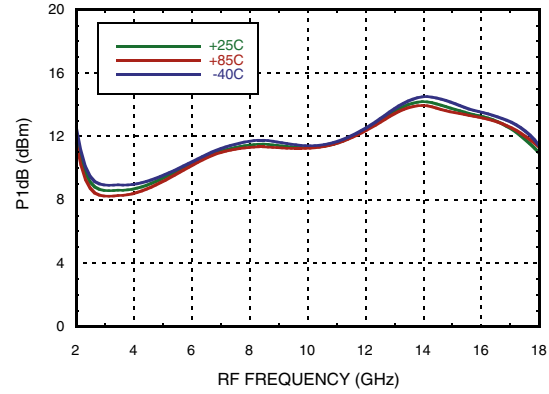

**Conversion Gain vs. Temperature,  
IF= 500 MHz, LO= 13dBm**

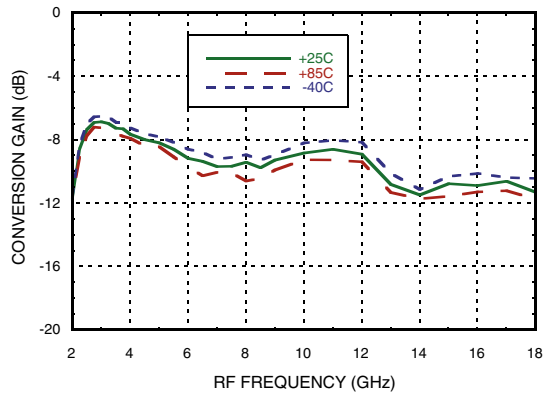

**Conversion Gain vs. LO Power,  
IF= 500 MHz**

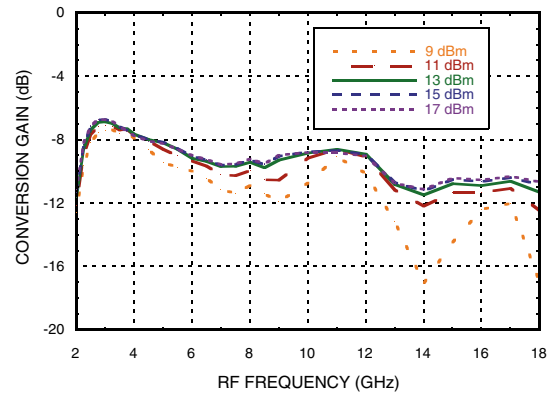

**Input IP3 vs. Temperature,  
IF= 500 MHz, LO= 13dBm**

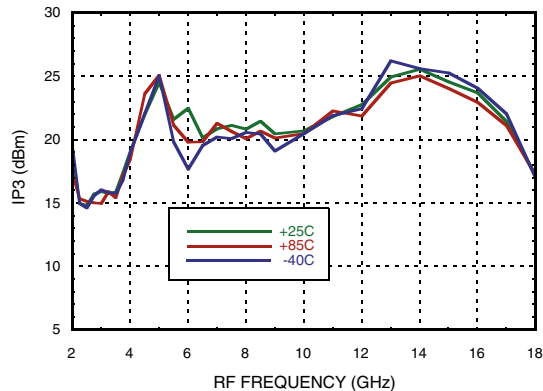

**Input IP3 vs. LO Power  
IF= 500 MHz**

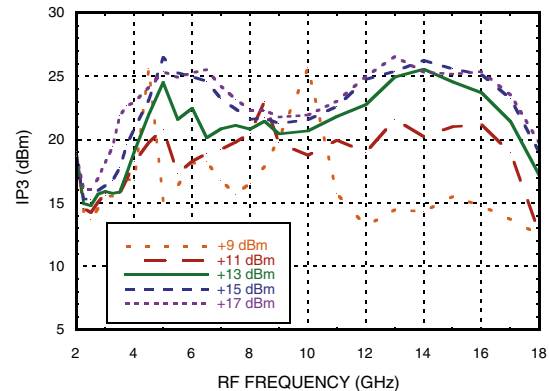

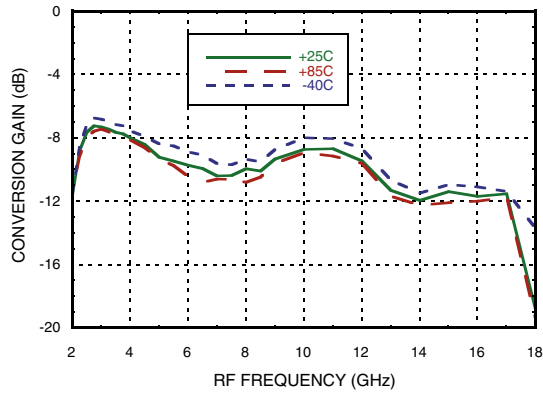
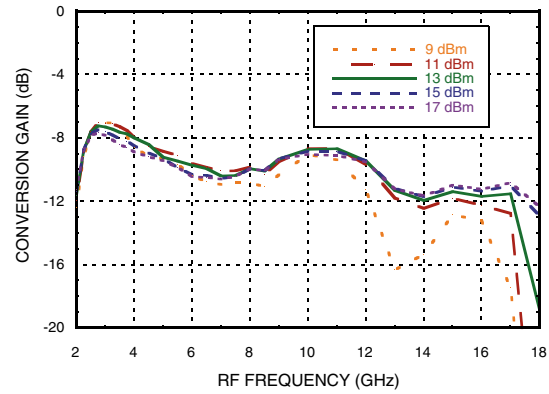
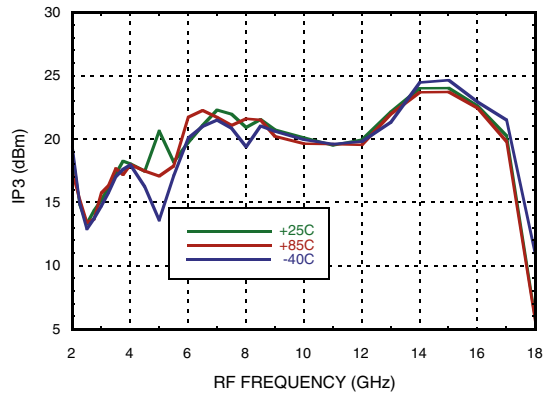
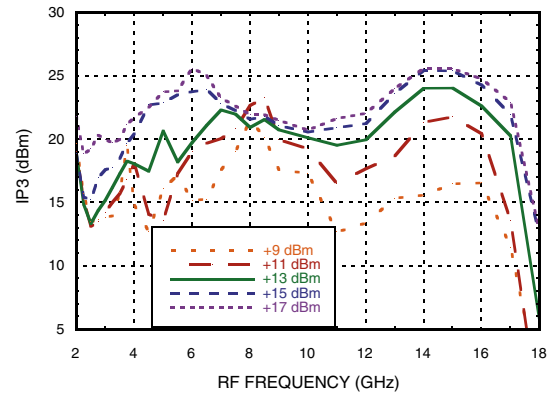
**GaAs MMIC DOUBLE-BALANCED  
MIXER, 2 - 18 GHz**
**Conversion Gain vs. Temperature,  
IF= 1500 MHz, LO= 13dBm**

**Conversion Gain vs. LO Power,  
IF= 1500 MHz**

**Input IP3 vs. Temperature,  
IF= 1500 MHz, LO= 13dBm**

**Input IP3 vs. LO Power  
IF= 1500 MHz**



**GaAs MMIC DOUBLE-BALANCED  
MIXER, 2 - 18 GHz**
**MxN Spurious Outputs,  
Downconverter**

mRF	nLO				
	0	1	2	3	4
0	x	-0.5	26.8	-2.4	29.6
1	7.5	0	16.2	18.8	28.5
2	62.2	55.2	55.5	48.1	58.3
3	65	63.7	63.6	67.7	67.3
4	63.5	67.1	65.3	68.9	69.3

RF = 2 GHz @ -10 dBm

LO = 2.1 GHz @ +13 dBm

All values in dBc below RF power level

**MxN Spurious Outputs,  
Upconverter**

mIF	nLO				
	0	1	2	3	4
0	x	-10.3	16.6	15.2	29.5
1	5.4	0	26.7	24	36.3
2	55.6	39.6	52.2	39.9	52
3	65.4	60.1	57.7	63.8	64.5
4	64.6	66.7	67.1	69.8	71.7

RF = 4 GHz @ -10 dBm

LO = 4.1 GHz @ +13 dBm

All values in dBc below IF power level

**Harmonics of LO**

LO Freq. (GHz)	nLO Spur at RF Port			
	1	2	3	4
2	60.76	45.98	58.15	56.06
4	39.86	31.63	49.77	43.87
6	43.29	31.08	51.66	58.58
10	39.12	31.05	62.34	64.12
12	32.53	42.18	32.52	70.08
14	45.01	53.44	41.58	NA

LO = + 13 dBm

Values in dBc below LO level measured at RF Port.

**Absolute Maximum Ratings**

RF / IF Input (LO = +18 dBm)	+15.5 dBm
LO Drive	+20 dBm
Max Junction Temperature @ 85°C w/ 19dBm	116°C
Continuous Pdiss (T=85°C) (derate 2.5 mW/°C above 85°C)	165 mW
Thermal Resistance (R <sub>TH</sub> ) (junction to package bottom)	392°C/W
Storage Temperature	-65 to +150 °C
Operating Temperature	-55 to +85 °C
ESD Sensitivity (HBM)	Class 1A

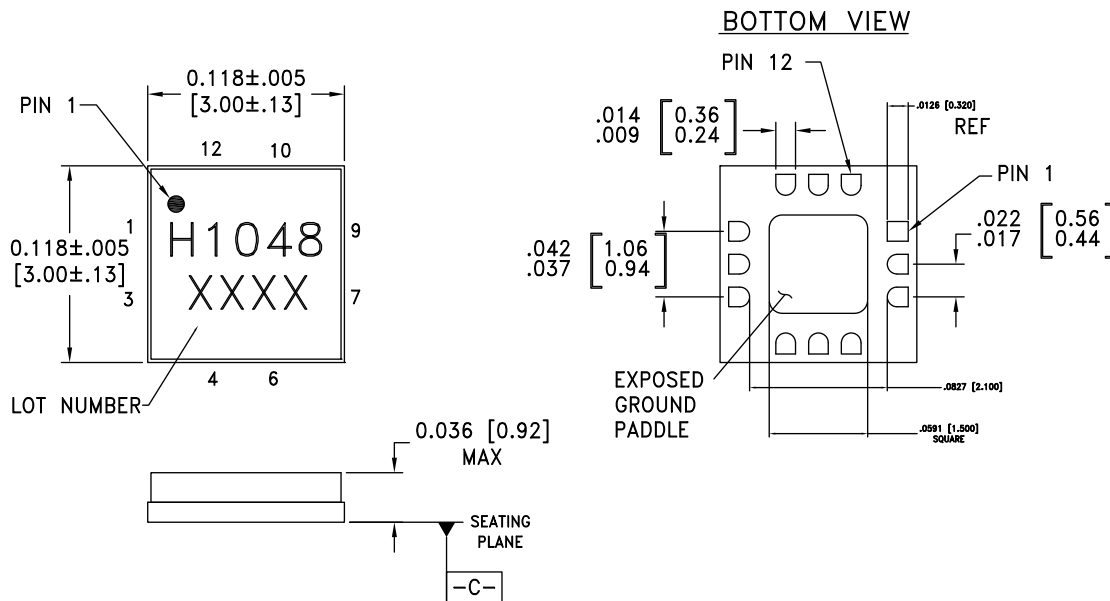
**ELECTROSTATIC SENSITIVE DEVICE  
OBSERVE HANDLING PRECAUTIONS**
**Outline Drawing**

**NOTES:**

1. PACKAGE BODY MATERIAL: ALUMINA
2. LEAD AND GROUND PADDLE PLATING: 30-80 MICROINCHES GOLD OVER 50 MICROINCHES MINIMUM NICKEL.
3. DIMENSIONS ARE IN INCHES [MILLIMETERS].
4. LEAD SPACING TOLERANCE IS NON-CUMULATIVE.
5. CHARACTERS TO BE BLACK INK MARKED WITH .018"MIN to .030"MAX HEIGHT REQUIREMENTS. UTILIZE MAXIMUM CHARACTER HEIGHT BASED ON LID DIMENSIONS AND BEST FIT. LOCATE APPROX. AS SHOWN.
6. PACKAGE WARP SHALL NOT EXCEED 0.05mm DATUM -C-
7. ALL GROUND LEADS AND GROUND PADDLE MUST BE SOLDERED TO PCB RF GROUND.

**Package Information**

Part Number	Package Body Material	Lead Finish	MSL Rating	Package Marking <sup>[2]</sup>
HMC1048LC3B	Alumina, White	Gold over Nickel	MSL1 <sup>[1]</sup>	H1048 XXXX

[1] Max peak reflow temperature of 260 °C

[2] 4-Digit lot number XXXX

**Pin Descriptions**

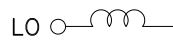
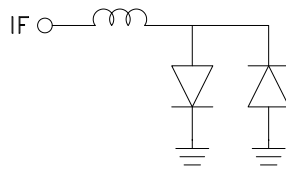
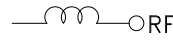
Pin Number	Function	Description	Interface Schematic
1, 3, 7, 9, 10, 12	GND	These pins and the exposed ground paddle must be connected to RF/DC ground.	
2	LO	This pin is matched to 50 Ohms.	
4, 6, 11	N/C	No connection required. These pins are not connected internally. However, all data shown herein was measured with these pins connected to ground.	
5	IF	This pin is DC coupled matched to 50 Ohms	
8	RF	This pin is matched to 50 Ohms	

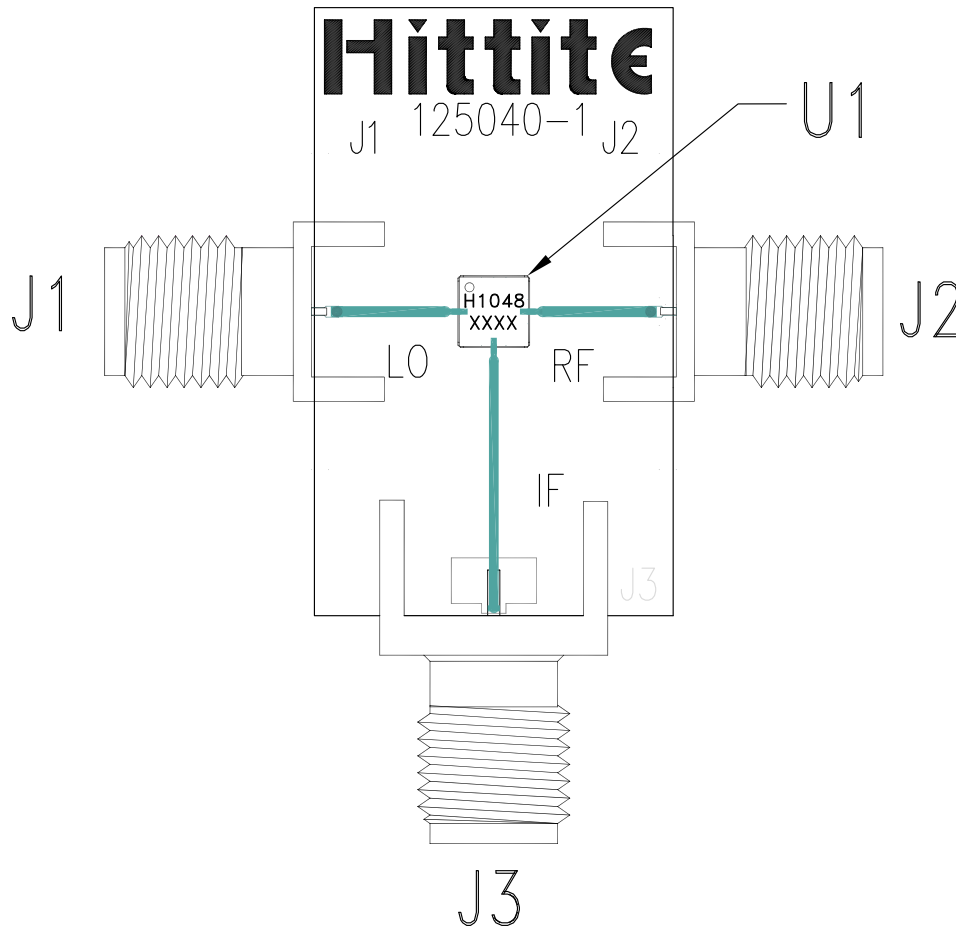
**Evaluation PCB**

**List of Materials for Evaluation PCB EVAL01-HMC1048LC3B <sup>[1]</sup>**

Item	Description
J1-J2	PCB Mount 2.9 mm K Connector, SRI
J3	PCB Mount SMA Connector
U1	HMC1048LC3B
PCB <sup>[2]</sup>	125040-1 Evaluation Board

[1] Reference this number when ordering complete evaluation PCB

[2] Circuit Board Material: Rogers 4350

The circuit board used in the application should use RF circuit design techniques. Signal lines should have 50 Ohm impedance while the package ground leads and exposed paddle should be connected directly to the ground plane similar to that shown. A sufficient number of via holes should be used to connect the top and bottom ground planes. The evaluation circuit board shown is available from Hittite upon request.



Компания «Океан Электроники» предлагает заключение долгосрочных отношений при поставках импортных электронных компонентов на взаимовыгодных условиях!

Наши преимущества:

- Поставка оригинальных импортных электронных компонентов напрямую с производств Америки, Европы и Азии, а так же с крупнейших складов мира;
- Широкая линейка поставок активных и пассивных импортных электронных компонентов (более 30 млн. наименований);
- Поставка сложных, дефицитных, либо снятых с производства позиций;
- Оперативные сроки поставки под заказ (от 5 рабочих дней);
- Экспресс доставка в любую точку России;
- Помощь Конструкторского Отдела и консультации квалифицированных инженеров;
- Техническая поддержка проекта, помощь в подборе аналогов, поставка прототипов;
- Поставка электронных компонентов под контролем ВП;
- Система менеджмента качества сертифицирована по Международному стандарту ISO 9001;
- При необходимости вся продукция военного и аэрокосмического назначения проходит испытания и сертификацию в лаборатории (по согласованию с заказчиком);
- Поставка специализированных компонентов военного и аэрокосмического уровня качества (Xilinx, Altera, Analog Devices, Intersil, Interpoint, Microsemi, Actel, Aeroflex, Peregrine, VPT, Syfer, Eurofarad, Texas Instruments, MS Kennedy, Miteq, Cobham, E2V, MA-COM, Hittite, Mini-Circuits, General Dynamics и др.);

Компания «Океан Электроники» является официальным дистрибьютором и эксклюзивным представителем в России одного из крупнейших производителей разъемов военного и аэрокосмического назначения «JONHON», а так же официальным дистрибьютором и эксклюзивным представителем в России производителя высокотехнологичных и надежных решений для передачи СВЧ сигналов «FORSTAR».



## JONHON

«JONHON» (основан в 1970 г.)

Разъемы специального, военного и аэрокосмического назначения:

(Применяются в военной, авиационной, аэрокосмической, морской, железнодорожной, горно- и нефтедобывающей отраслях промышленности)

«FORSTAR» (основан в 1998 г.)

ВЧ соединители, коаксиальные кабели, кабельные сборки и микроволновые компоненты:

(Применяются в телекоммуникациях гражданского и специального назначения, в средствах связи, РЛС, а так же военной, авиационной и аэрокосмической отраслях промышленности).



Телефон: 8 (812) 309-75-97 (многоканальный)

Факс: 8 (812) 320-03-32

Электронная почта: [ocean@oceanchips.ru](mailto:ocean@oceanchips.ru)

Web: <http://oceanchips.ru/>

Адрес: 198099, г. Санкт-Петербург, ул. Калинина, д. 2, корп. 4, лит. А