



PD57006-E

RF POWER transistor, LdmoST plastic family N-channel enhancement-mode, lateral MOSFETs

Features

- Excellent thermal stability
- Common source configuration
- $P_{OUT} = 6\text{ W}$ with 15dB gain @ 945 MHz / 28 V
- New RF plastic package

Description

The device is a common source N-channel, enhancement-mode lateral field-effect RF power transistor. It is designed for high gain, broad band commercial and industrial applications. It operates at 28 V in common source mode at frequencies of up to 1 GHz. The device boasts the excellent gain, linearity and reliability of ST's latest LDMOS technology mounted in the first true SMD plastic RF power package, PowerSO-10RF. Device's superior linearity performance makes it an ideal solution for car mobile radio. The PowerSO-10 plastic package, designed to offer high reliability, is the first ST JEDEC approved, high power SMD package. It has been specially optimized for RF needs and offers excellent RF performance and ease of assembly. Mounting recommendations are available in www.st.com/rf/ (look for application note AN1294).

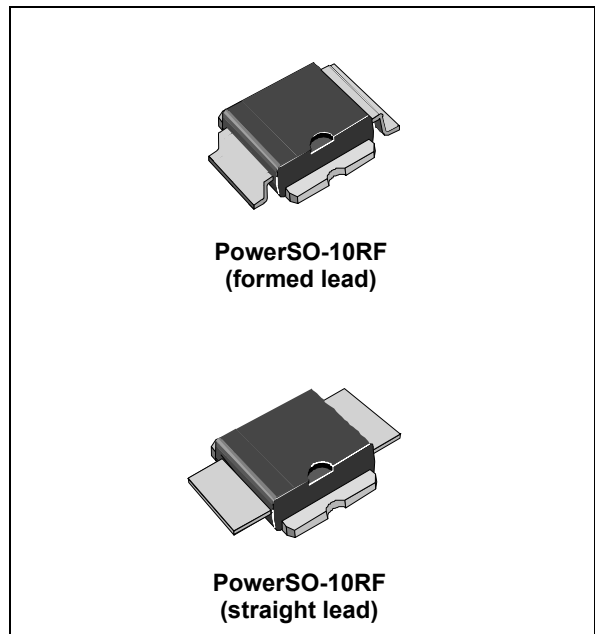

Figure 1. Pin connection

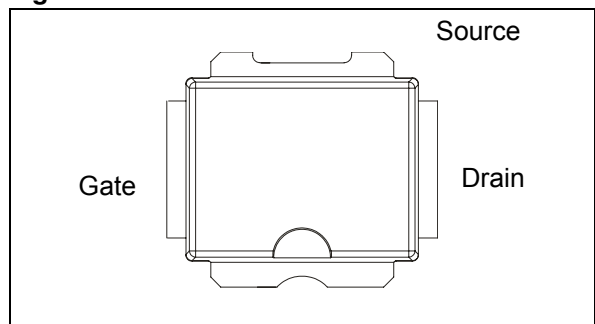

Table 1. Device summary

Order code	Package	Packing
PD57006-E	PowerSO-10RF (formed lead)	Tube
PD57006S-E	PowerSO-10RF (straight lead)	Tube
PD57006TR-E	PowerSO-10RF (formed lead)	Tape and reel
PD57006STR-E	PowerSO-10RF (straight lead)	Tape and reel

Contents

1	Electrical data	3
1.1	Maximum ratings	3
1.2	Thermal data	3
2	Electrical characteristics	4
2.1	Static	4
2.2	Dynamic	4
2.3	Moisture sensitivity level	4
3	Impedance	5
4	Typical performance	6
4.1	PD57006-E	7
4.2	PD5706S-E	9
5	Test circuit	12
6	Common source s-parameter	14
7	Package mechanical data	16
8	Revision history	21

1 Electrical data

1.1 Maximum ratings

Table 2. Absolute maximum ratings ($T_{CASE} = 25^{\circ}C$)

Symbol	Parameter	Value	Unit
$V_{(BR)DSS}$	Drain-source voltage	65	V
V_{GS}	Gate-source voltage	± 20	V
I_D	Drain current	1	A
P_{DISS}	Power dissipation (@ $T_C = 70^{\circ}C$)	20	W
T_J	Max. operating junction temperature	165	$^{\circ}C$
T_{STG}	Storage temperature	-65 to +150	$^{\circ}C$

1.2 Thermal data

Table 3. Thermal data

Symbol	Parameter	Value	Unit
R_{thJC}	Junction - case thermal resistance	5	$^{\circ}C/W$

2 Electrical characteristics

$T_{CASE} = +25\text{ }^{\circ}\text{C}$

2.1 Static

Table 4. Static

Symbol	Test conditions			Min	Typ	Max	Unit
$V_{(BR)DSS}$	$V_{GS} = 0\text{ V}$	$I_D = 10\text{ mA}$		65			
I_{DSS}	$V_{GS} = 0\text{ V}$	$V_{DS} = 28\text{ V}$				1	μA
I_{GSS}	$V_{GS} = 20\text{ V}$	$V_{DS} = 0\text{ V}$				1	μA
$V_{GS(Q)}$	$V_{DS} = 28\text{ V}$	$I_D = 70\text{ mA}$		2.0		5.0	V
$V_{DS(ON)}$	$V_{GS} = 10\text{ V}$	$I_D = 0.5\text{ A}$				0.9	V
g_{FS}	$V_{DS} = 10\text{ V}$	$I_D = 800\text{ mA}$			0.58		mho
C_{ISS}	$V_{GS} = 0\text{ V}$	$V_{DS} = 28\text{ V}$	$f = 1\text{ MHz}$		27		pF
C_{OSS}	$V_{GS} = 0\text{ V}$	$V_{DS} = 28\text{ V}$	$f = 1\text{ MHz}$		14		pF
C_{RSS}	$V_{GS} = 0\text{ V}$	$V_{DS} = 28\text{ V}$	$f = 1\text{ MHz}$		0.9		pF

2.2 Dynamic

Table 5. Dynamic

Symbol	Test conditions			Min	Typ	Max	Unit
P_{OUT}	$V_{DD} = 28\text{ V}$	$I_{DQ} = 70\text{ mA}$	$f = 945\text{ MHz}$	6			W
G_P	$V_{DD} = 28\text{ V}$	$I_{DQ} = 70\text{ mA}$	$P_{OUT} = 6\text{ W}$ $f = 945\text{ MHz}$	14	15		dB
η_D	$V_{DD} = 28\text{ V}$	$I_{DQ} = 70\text{ mA}$	$P_{OUT} = 6\text{ W}$ $f = 945\text{ MHz}$	45	50		%
Load mismatch	$V_{DD} = 28\text{ V}$	$I_{DQ} = 70\text{ mA}$	$P_{OUT} = 6\text{ W}$ $f = 945\text{ MHz}$ All phase angles	10:1			VSWR

2.3 Moisture sensitivity level

Table 6. Moisture sensitivity level

Test methodology	Rating
J-STD-020B	MSL 3

3 Impedance

Figure 2. Current conventions



Table 7. Impedance data

PD57006-E			PD57006S-E		
Freq. (MHz)	Z _{IN} (Ω)	Z _{DL} (Ω)	Freq. (MHz)	Z _{IN} (Ω)	Z _{DL} (Ω)
925	6.040 - j 0.936	6.273 + j 8.729	925	3.794 - j 1.632	3.513 + j 10.81
945	5.886 - j 2.326	6.578 + j 5.999	945	4.039 - j 2.300	3.862 + j 10.58
960	6.056 - j 3.522	7.215 + j 7.539	960	4.250 - j 3.791	4.005 + j 11.34

4 Typical performance

Figure 3. Capacitance vs supply voltage

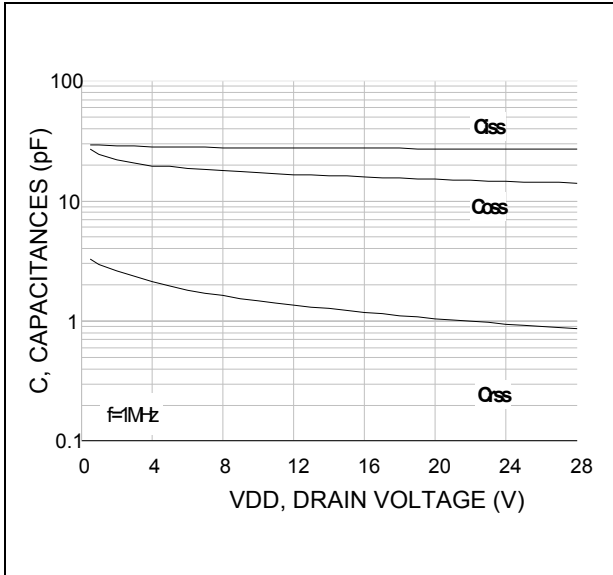

Figure 4. Drain current vs gate source voltage

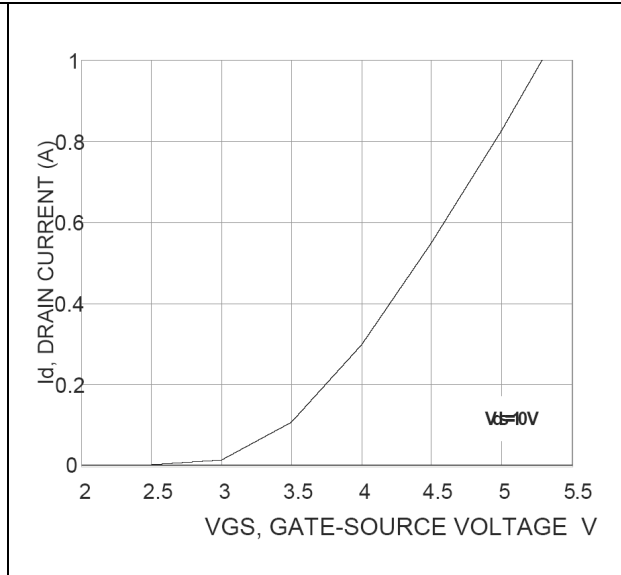
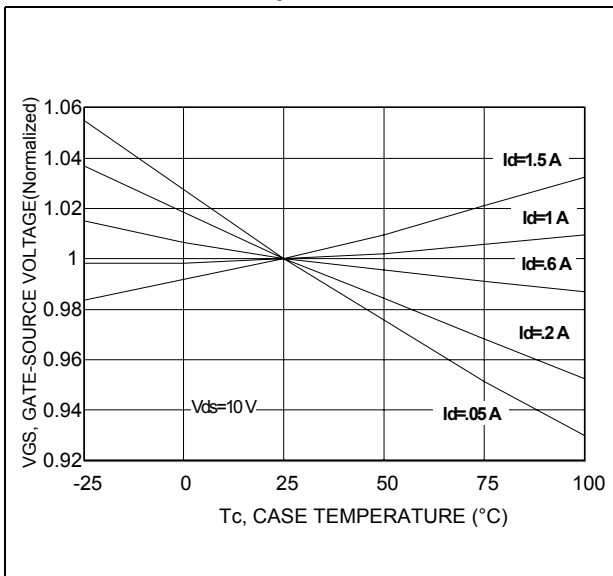

Figure 5. Gate-source voltage vs case temperature



4.1 PD57006-E

Figure 6. Output power vs input power

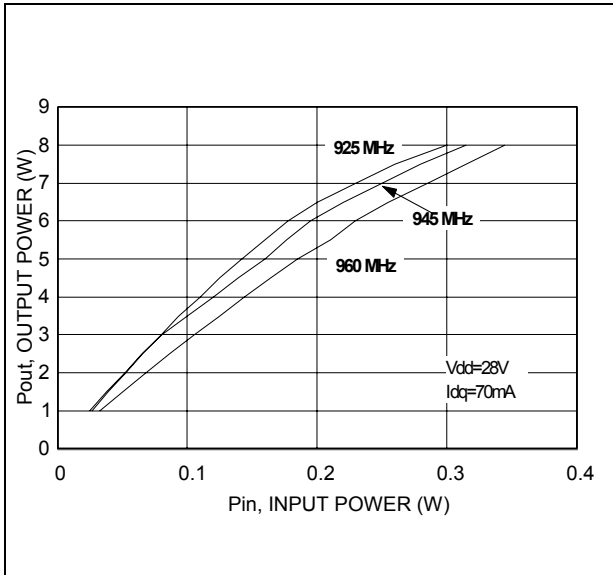

Figure 7. Input return loss vs output power

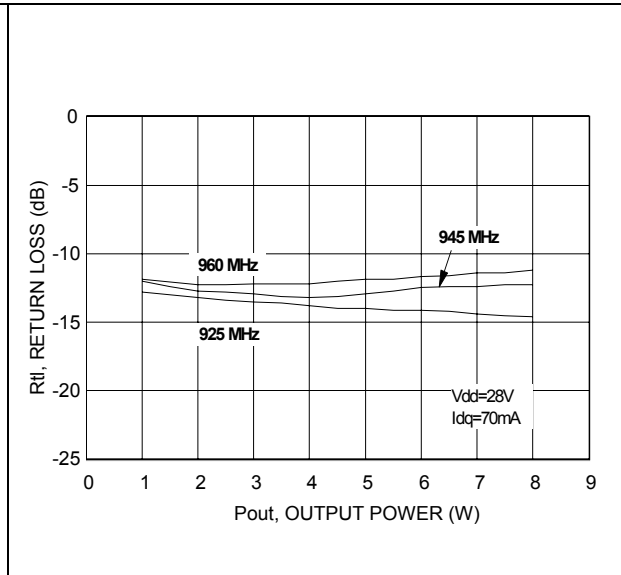

Figure 8. Power gain vs output power

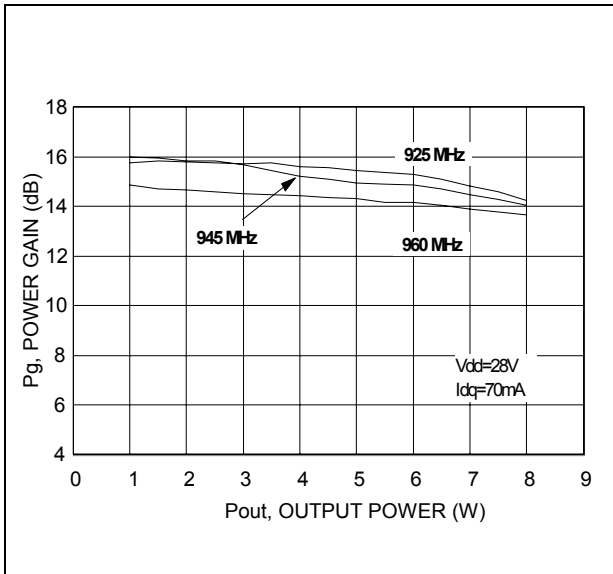

Figure 9. Drain efficiency vs output power

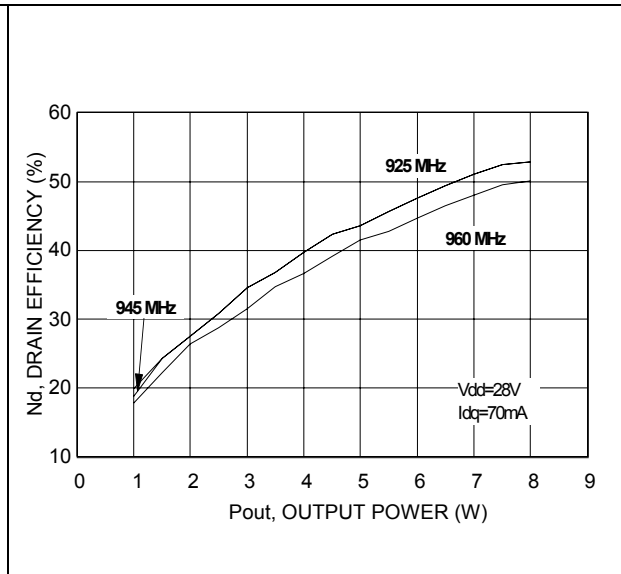

Figure 10. Output power vs drain voltage

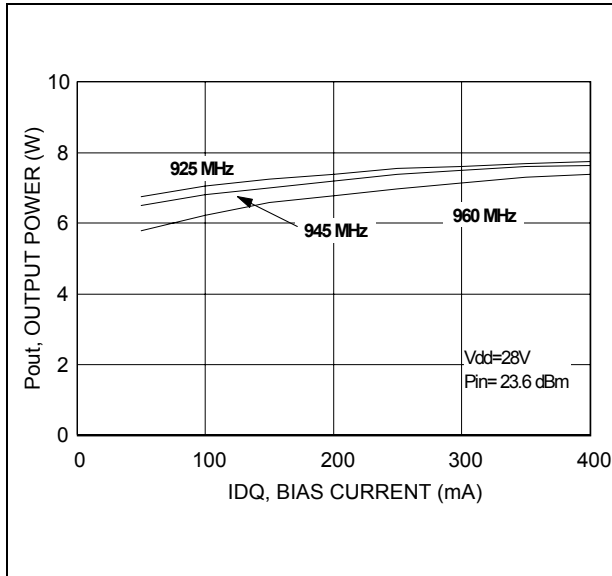

Figure 11. Drain efficiency vs bias current

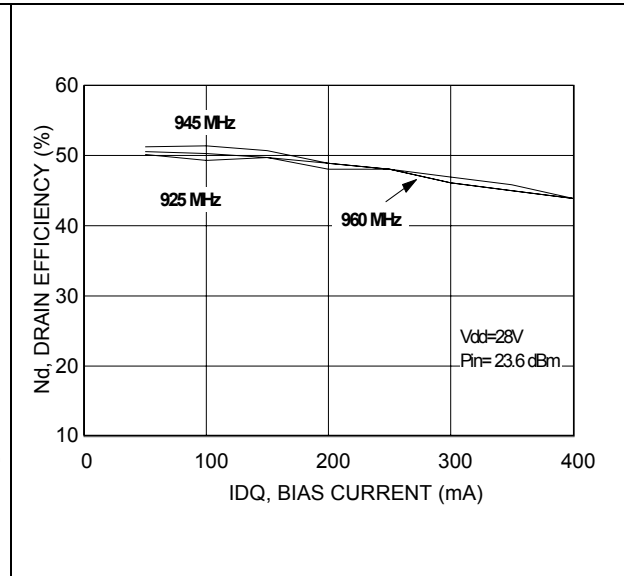

Figure 12. Output power vs supply voltage

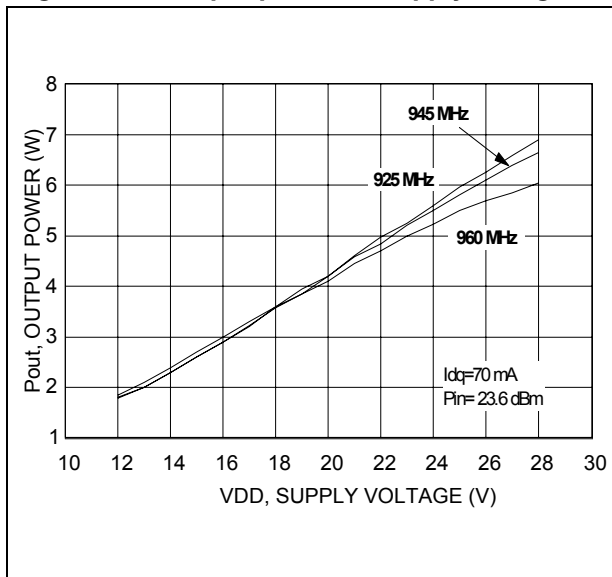

Figure 13. Drain efficiency vs supply voltage

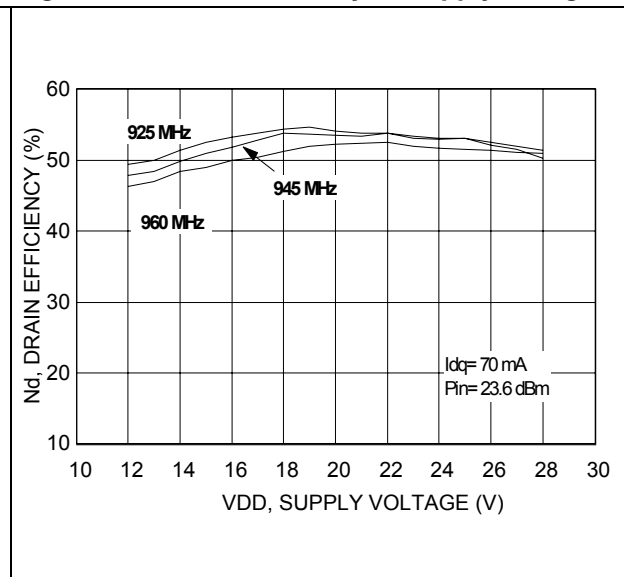
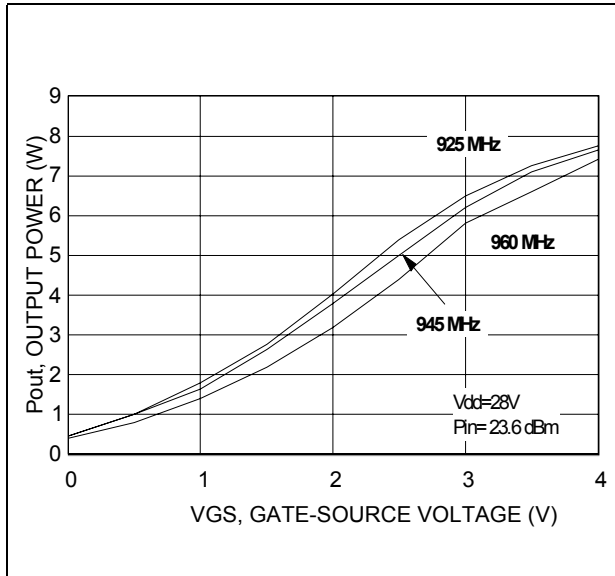

Figure 14. Output power vs gate-source voltage



4.2 PD5706S-E

Figure 15. Output power vs input power

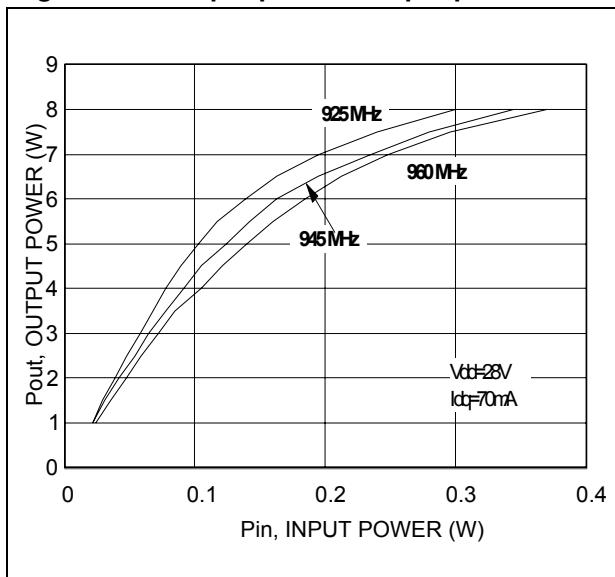

Figure 16. Input return loss vs output power

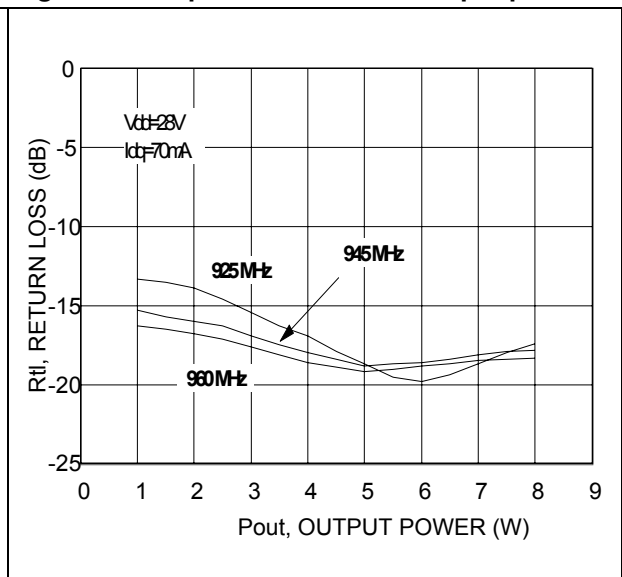

Figure 17. Power gain vs output power

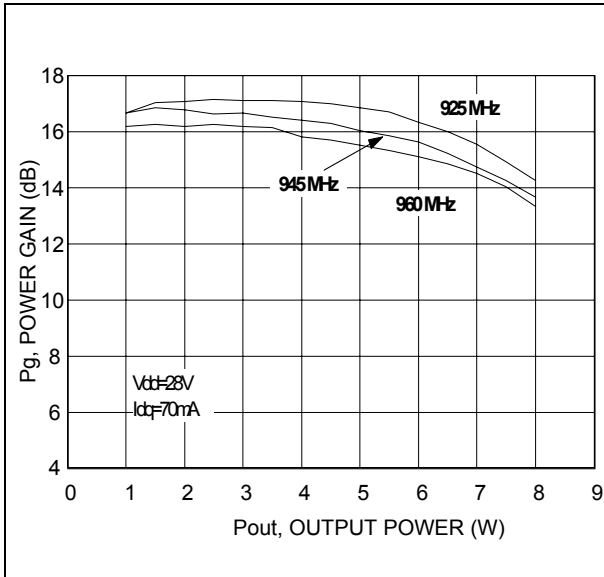

Figure 18. Drain efficiency vs output power

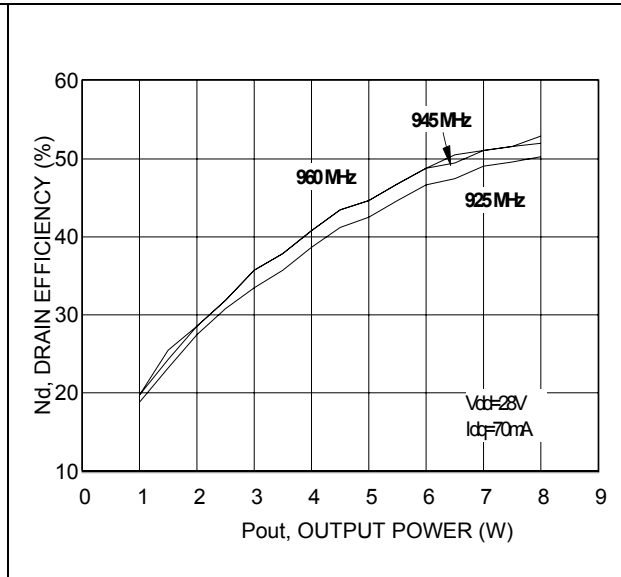

Figure 19. Output power vs bias current

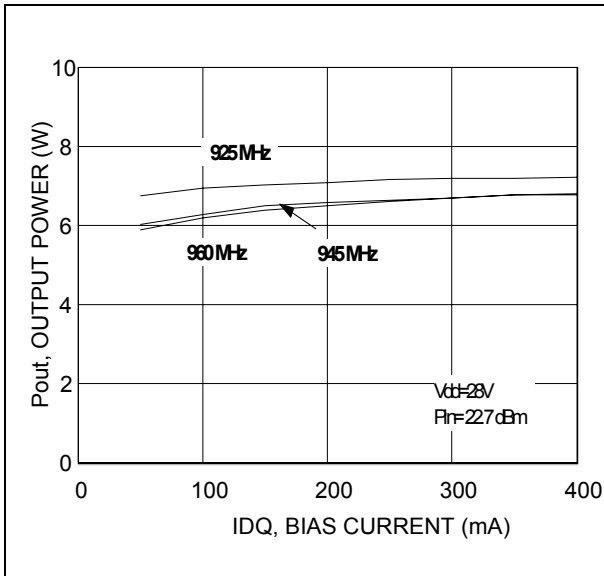

Figure 20. Drain efficiency vs bias current

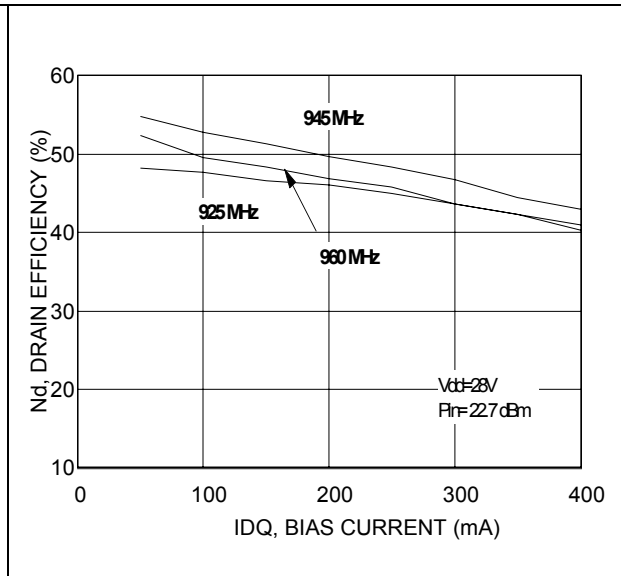

Figure 21. Output power vs supply voltage

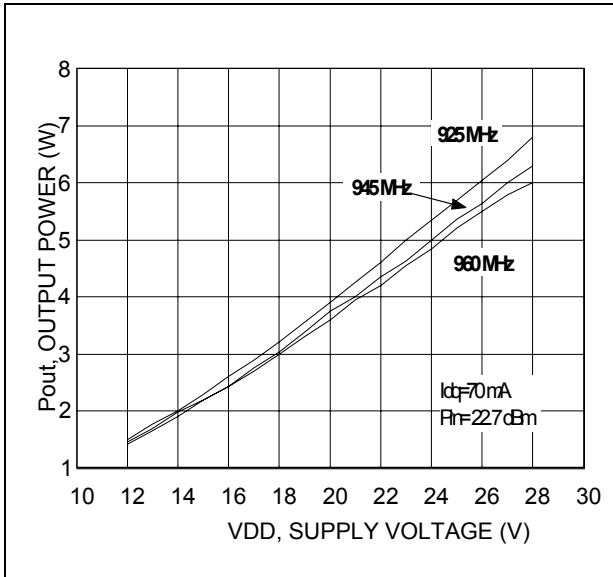

Figure 22. Drain efficiency vs supply voltage

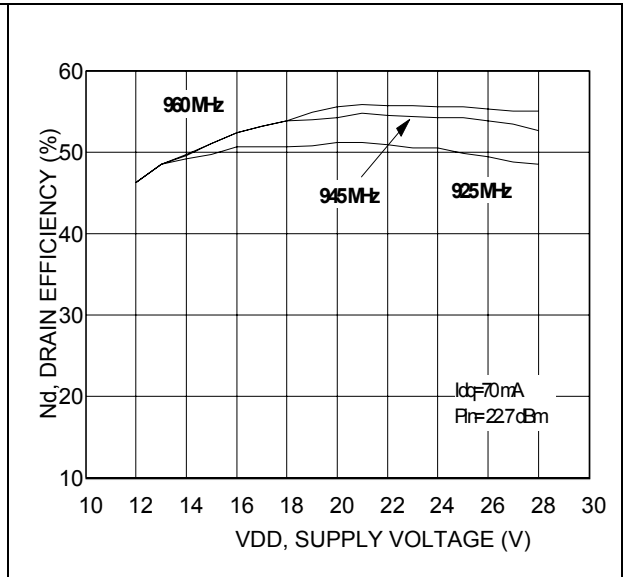
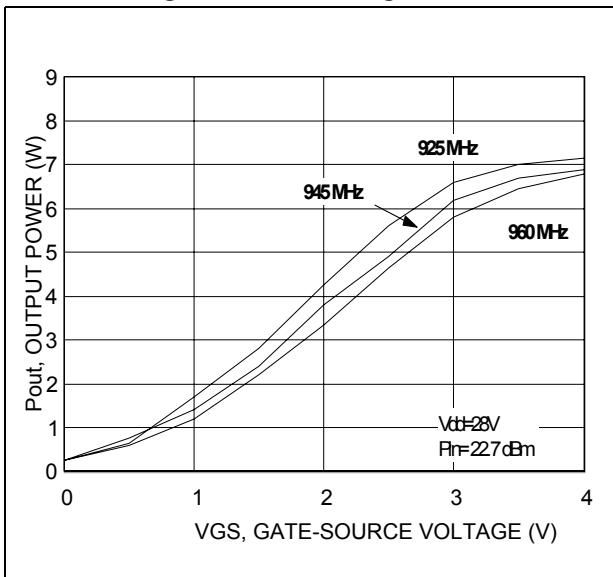

Figure 23. Output power vs gate-source voltage



5 Test circuit

Figure 24. Test circuit schematic

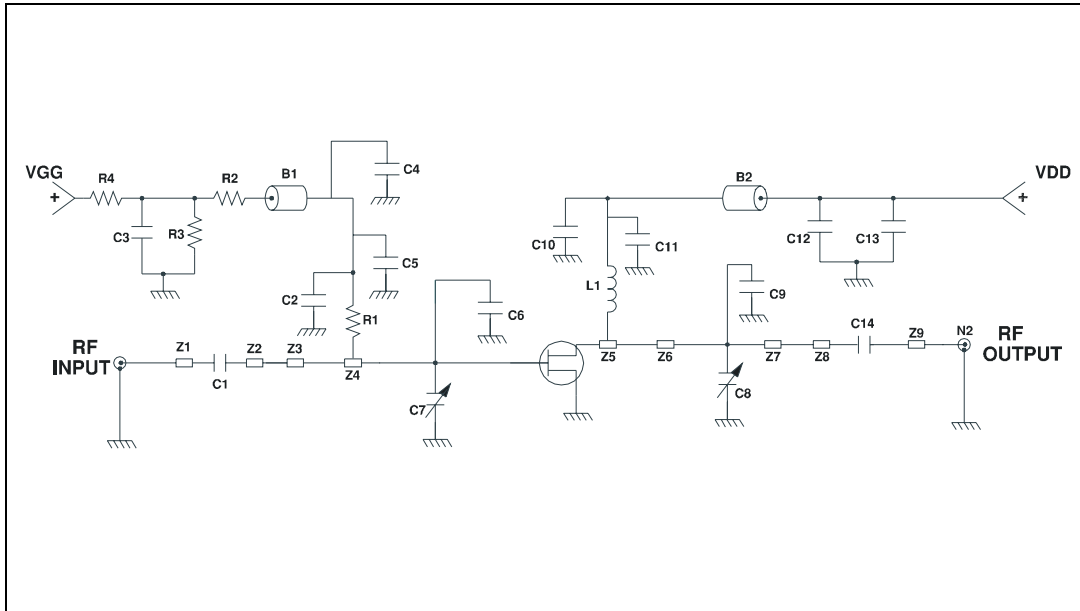

Table 8. Test circuit component part list

B1, B2	SHORT FERRITE BEAD, FAIR RITE PRODUCTS (2743021446)	R2	18 kΩ CHIP RESISTOR 1 W
C1, C2, C11, C14	47 pF, 100B ATC CHIP CAPACITOR	R3	4.7 mΩ CHIP RESISTOR 1 W
C5	1000 pF, 100B ATC CHIP CAPACITOR	R4	12 kΩ CHIP RESISTOR 1 W
C4, C12	.01 μF, VENKEL CHIP CAPACITOR	Z1	0.430" X 0.084" MICROSTRIP
C3, C13	220 μF, 63 V ELECTROLYTIC CAPACITOR	Z2	0.1.186" X 1.120" MICROSTRIP
C10	100 pF, 100B ATC CHIP CAPACITOR	Z3	1.273" X 0.565" MICROSTRIP
C9	6.2 pF, 100B ATC CHIP CAPACITOR	Z4	0.770" X 0.171" MICROSTRIP
C7, C8	08-8 pF VARIABLE CAPACITOR JOHANSON	Z5	0.880" X 0.105" MICROSTRIP
L1	15 nH, 3 TURN, .140" DIA. 22 AWG BELDEN 8021 BLIS PER WIRE	Z6	1.200" X 0.084" MICROSTRIP
N1, N2	TYPE N FLANGE MOUNT	BOARD	ROGER ULTRA LAM 2000 THK 0.030" ε _r = 2.55 2oz ED Cu BOTH SIDES
R1	100 Ω CHIP RESISTOR 1 W		

Figure 25. Test circuit photomaster

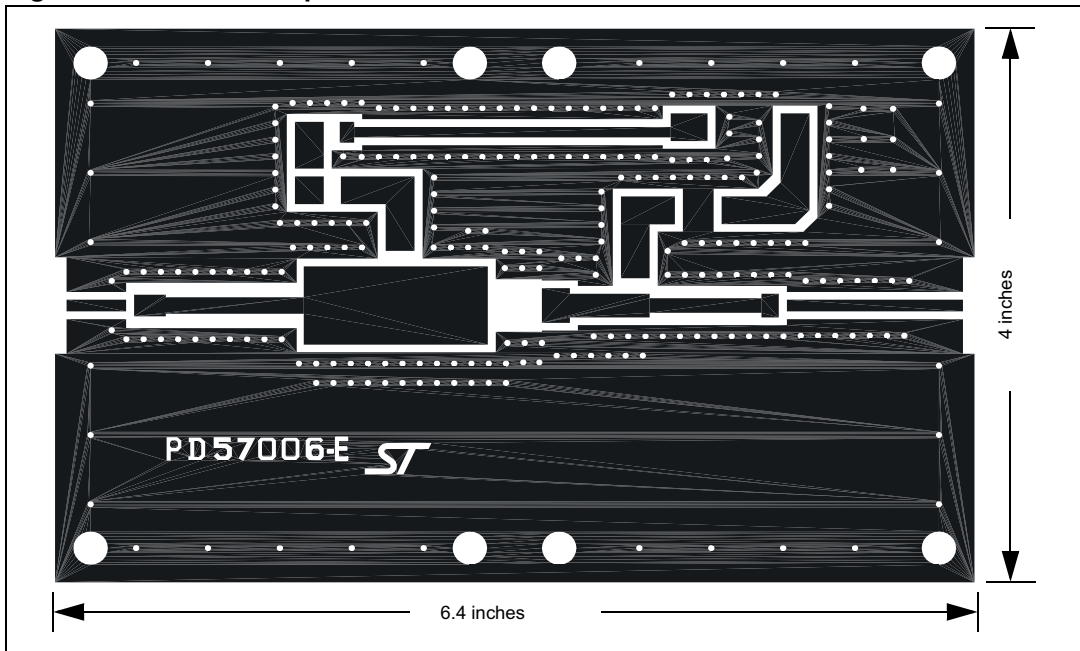

Figure 26. Test circuit

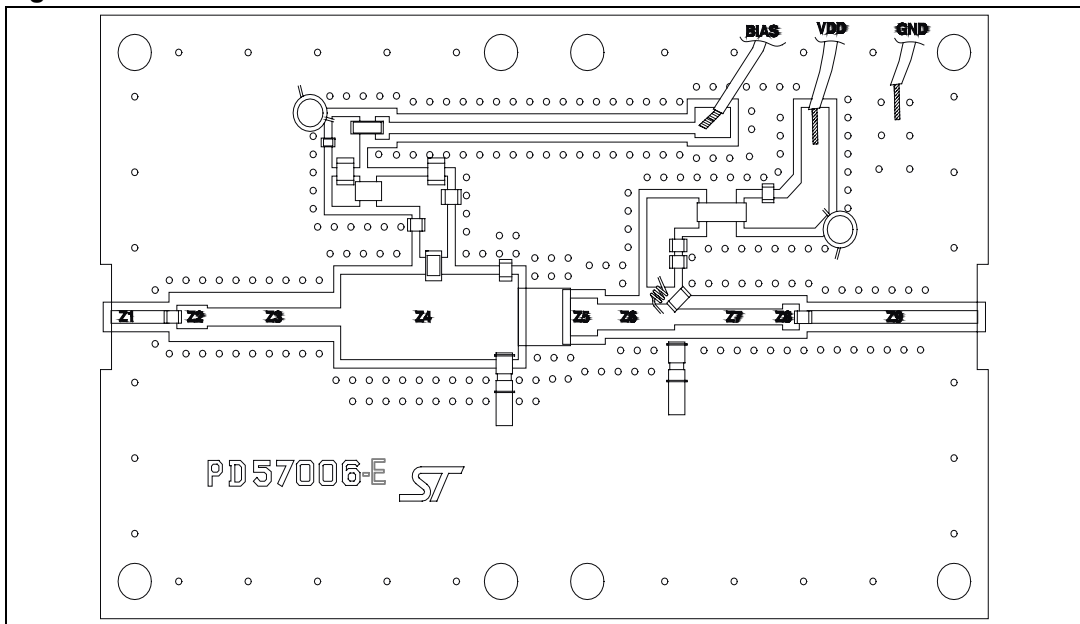

Table 9. Transmission line dimensions

Z1	0.430" X 0.084" MICROSTRIP	Z4	1.273" X 0.565" MICROSTRIP	Z7	0.778" X 0.150" MICROSTRIP
Z2	0.220" X 0.155" MICROSTRIP	Z5	0.195" X 0.250" MICROSTRIP	Z8	0.120" X 0.171" MICROSTRIP
Z3	0.960" X 0.120" MICROSTRIP	Z6	0.555" X 0.171" MICROSTRIP	Z8	1.200" X 0.084" MICROSTRIP

6 Common source s-parameter

Table 10. S-parameter for PD57006-E ($V_{DS} = 13.5\text{ V}$ $I_{DS} = 0.2\text{ A}$)

Freq (MHz)	$ S_{11} $	$S_{11} < \Phi$	$ S_{21} $	$S_{21} < \Phi$	$ S_{12} $	$S_{12} < \Phi$	$ S_{22} $	$S_{22} < \Phi$
50	0.895	-79	29.76	130	0.033	39	0.814	-70
100	0.786	-118	18.68	102	0.041	13	0.699	-106
150	0.765	-134	12.61	90	0.042	2	0.621	-121
200	0.767	-143	9.22	80	0.041	-8	0.629	-132
250	0.778	-151	7.50	73	0.041	-15	0.629	-136
300	0.790	-156	6.09	66	0.038	-22	0.650	-141
350	0.794	-159	5.23	59	0.038	-28	0.685	-143
400	0.806	-162	4.39	54	0.036	-32	0.700	-147
450	0.814	-165	3.82	48	0.035	-37	0.724	-149
500	0.826	-167	3.30	43	0.033	-41	0.749	-152
550	0.836	-170	2.90	38	0.031	-45	0.771	-154
600	0.843	-172	2.59	34	0.029	-49	0.785	-1564
650	0.850	-174	2.32	31	0.028	-53	0.803	-158
700	0.857	-176	2.09	27	0.027	-56	0.814	-1598
750	0.863	-178	1.91	23	0.025	-59	0.829	-162
800	0.869	-180	1.76	20	0.024	-62	0.839	-163
850	0.869	178	1.61	16	0.023	-64	0.847	-165
900	0.872	177	1.50	13	0.022	-68	0.859	-166
950	0.875	175	1.40	10	0.020	-72	0.868	-168
1000	0.873	173	1.32	7	0.020	-75	0.873	-169
1050	0.875	172	1.24	3	0.019	-78	0.885	-171
1100	0.872	170	1.18	0	0.019	-81	0.886	-172
1150	0.871	168	1.12	-4	0.018	-86	0.889	-174
1200	0.864	166	1.08	-7	0.017	-92	0.890	-175
1250	0.861	164	1.03	-11	0.016	-97	0.895	-177
1300	0.855	163	1.00	-15	0.016	-102	0.896	-178
1350	0.847	160	0.96	-19	0.015	-108	0.895	-180
1400	0.835	158	0.93	-23	0.015	-111	0.897	179
1450	0.818	156	0.89	-27	0.015	-120	0.896	178
1500	0.797	153	0.88	-31	0.016	-128	0.899	177

Table 11. S-parameter PD57006-E ($V_{DS} = 28\text{ V}$ $I_{DS} = 0.2\text{ A}$)

Freq (MHz)	$ S_{11} $	$\angle S_{11}$	$ S_{21} $	$\angle S_{21}$	$ S_{12} $	$\angle S_{12}$	$ S_{22} $	$\angle S_{22}$
50	0.953	-65	31.01	138	0.022	48	0.780	-52
100	0.855	-104	21.59	112	0.030	20	0.677	-85
150	0.823	-124	15.49	96	0.031	7	0.601	-101
200	0.818	-136	11.84	85	0.031	-5	0.605	-113
250	0.824	-144	9.54	75	0.031	-12	0.614	-118
300	0.832	-150	7.85	67	0.029	-19	0.635	-126
350	0.835	-155	6.48	59	0.029	-25	0.676	-129
400	0.845	-159	5.51	53	0.027	-31	0.696	-134
450	0.850	-162	4.69	4	0.025	-36	0.722	-137
500	0.860	-165	4.11	43	0.024	-41	0.748	-141
550	0.866	-168	3.58	38	0.023	-44	0.773	-144
600	0.870	-170	3.21	33	0.021	-48	0.790	-147
650	0.878	-172	2.88	29	0.019	-53	0.808	-150
700	0.883	-174	2.60	25	0.019	-53	0.821	-152
750	0.887	-177	2.37	21	0.016	-59	0.838	-154
800	0.890	-179	2.16	17	0.017	-60	0.846	-156
850	0.890	179	1.98	13	0.015	-62	0.856	-158
900	0.888	178	1.82	9	0.014	-67	0.869	-160
950	0.892	176	1.69	6	0.013	-70	0.879	-162
1000	0.894	174	1.57	3	0.013	-72	0.886	-163
1050	0.892	172	1.47	0	0.011	-76	0.892	-165
1100	0.888	170	1.36	-3	0.011	-80	0.894	-166
1150	0.885	169	1.28	-6	0.010	-86	0.899	-168
1200	0.880	167	1.21	-9	0.009	-89	0.897	-170
1250	0.872	165	1.16	-11	0.009	-95	0.901	-171
1300	0.864	163	1.11	-14	0.008	-103	0.906	-173
1350	0.856	161	1.09	-17	0.007	-110	0.905	-174
1400	0.844	159	1.06	-20	0.007	-118	0.905	-176
1450	0.824	156	1.06	-23	0.007	-129	0.906	-177
1500	0.806	154	1.04	-29	0.008	-143	0.910	-178

7 Package mechanical data

In order to meet environmental requirements, ST offers these devices in different grades of ECOPACK[®] packages, depending on their level of environmental compliance. ECOPACK[®] specifications, grade definitions and product status are available at: www.st.com. ECOPACK[®] is an ST trademark.

Table 12. PowerSO-10RF formed lead (Gull Wing) mechanical data

Dim.	mm.			Inch		
	Min.	Typ.	Max.	Min.	Typ.	Max.
A1	0	0.05	0.1	0.	0.0019	0.0038
A2	3.4	3.5	3.6	0.134	0.137	0.142
A3	1.2	1.3	1.4	0.046	0.05	0.054
A4	0.15	0.2	0.25	0.005	0.007	0.009
a		0.2			0.007	
b	5.4	5.53	5.65	0.212	0.217	0.221
c	0.23	0.27	0.32	0.008	0.01	0.012
D	9.4	9.5	9.6	0.370	0.374	0.377
D1	7.4	7.5	7.6	0.290	0.295	0.298
E	13.85	14.1	14.35	0.544	0.555	0.565
E1	9.3	9.4	9.5	0.365	0.37	0.375
E2	7.3	7.4	7.5	0.286	0.292	0.294
E3	5.9	6.1	6.3	0.231	0.24	0.247
F		0.5			0.019	
G		1.2			0.047	
L	0.8	1	1.1	0.030	0.039	0.042
R1			0.25			0.01
R2		0.8			0.031	
T	2 deg	5 deg	8 deg	2 deg	5 deg	8 deg
T1		6 deg			6 deg	
T2		10 deg			10 deg	

Note: Resin protrusions not included (max value: 0.15 mm per side)

Figure 27. Package dimensions

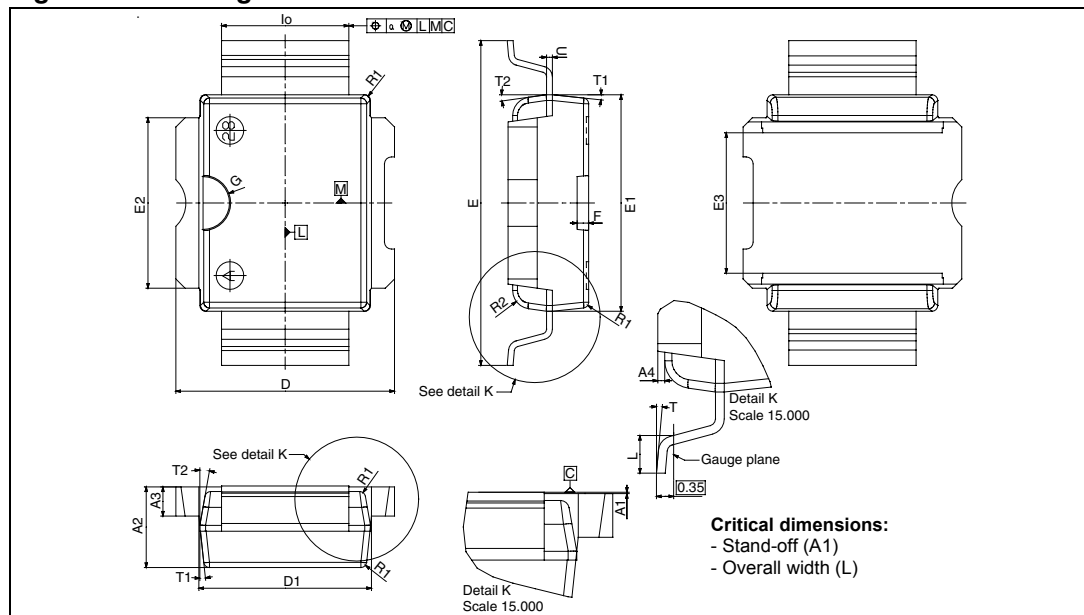

Table 13. PowerSO-10RF straight lead mechanical data

Dim.	mm.			Inch		
	Min.	Typ.	Max.	Min.	Typ.	Max.
A1	1.62	1.67	1.72	0.064	0.065	0.068
A2	3.4	3.5	3.6	0.134	0.137	0.142
A3	1.2	1.3	1.4	0.046	0.05	0.054
A4	0.15	0.2	0.25	0.005	0.007	0.009
a		0.2			0.007	
b	5.4	5.53	5.65	0.212	0.217	0.221
c	0.23	0.27	0.32	0.008	0.01	0.012
D	9.4	9.5	9.6	0.370	0.374	0.377
D1	7.4	7.5	7.6	0.290	0.295	0.298
E	15.15	15.4	15.65	0.595	0.606	0.615
E1	9.3	9.4	9.5	0.365	0.37	0.375
E2	7.3	7.4	7.5	0.286	0.292	0.294
E3	5.9	6.1	6.3	0.231	0.24	0.247
F		0.5			0.019	
G		1.2			0.047	
R1			0.25			0.01
R2		0.8			0.031	
T1		6 deg			6 deg	
T2		10 deg			10 deg	

Note: Resin protrusions not included (max value: 0.15 mm per side)

Figure 28. Package dimensions

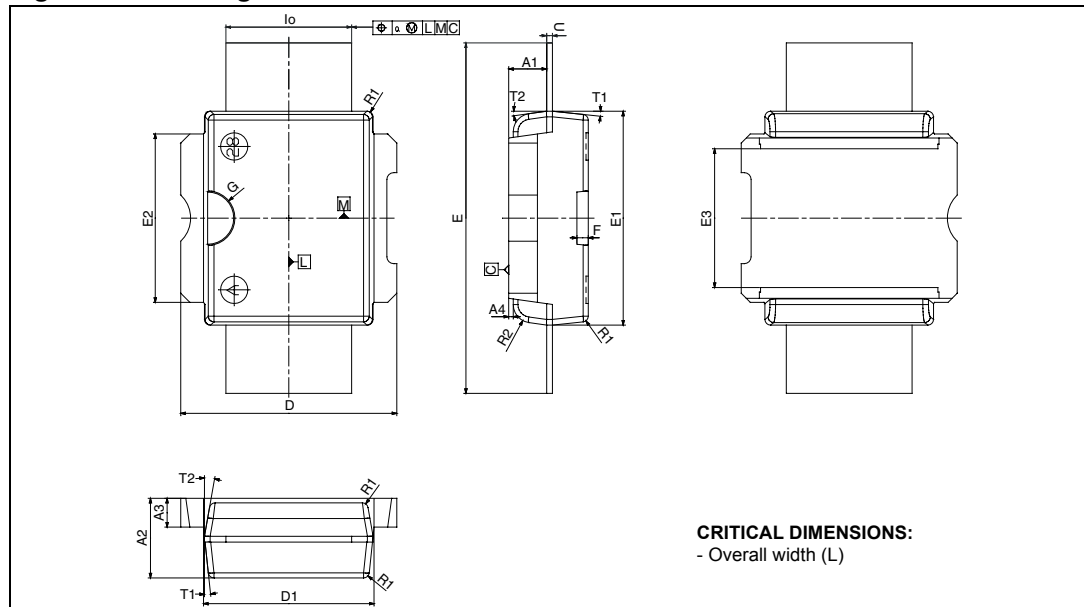
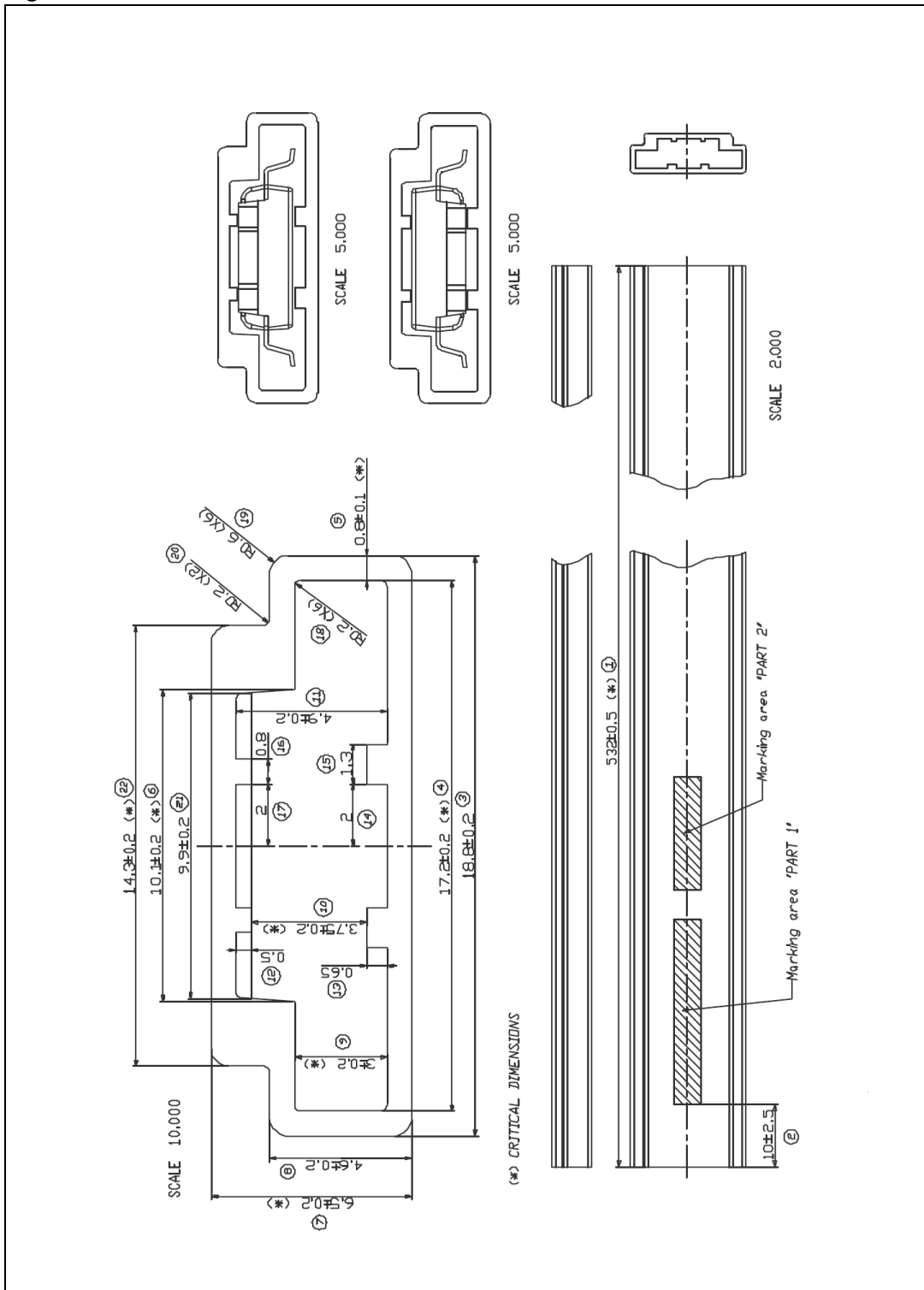

Figure 29. Tube information



8 Revision history

Table 14. Document revision history

Date	Revision	Changes
06-May-2006	1	Initial release.
25-May-2010	2	Added: Table 6: Moisture sensitivity level .
03-Jan-2011	3	Content reworked to improve readability

Please Read Carefully:

Information in this document is provided solely in connection with ST products. STMicroelectronics NV and its subsidiaries ("ST") reserve the right to make changes, corrections, modifications or improvements, to this document, and the products and services described herein at any time, without notice.

All ST products are sold pursuant to ST's terms and conditions of sale.

Purchasers are solely responsible for the choice, selection and use of the ST products and services described herein, and ST assumes no liability whatsoever relating to the choice, selection or use of the ST products and services described herein.

No license, express or implied, by estoppel or otherwise, to any intellectual property rights is granted under this document. If any part of this document refers to any third party products or services it shall not be deemed a license grant by ST for the use of such third party products or services, or any intellectual property contained therein or considered as a warranty covering the use in any manner whatsoever of such third party products or services or any intellectual property contained therein.

UNLESS OTHERWISE SET FORTH IN ST'S TERMS AND CONDITIONS OF SALE ST DISCLAIMS ANY EXPRESS OR IMPLIED WARRANTY WITH RESPECT TO THE USE AND/OR SALE OF ST PRODUCTS INCLUDING WITHOUT LIMITATION IMPLIED WARRANTIES OF MERCHANTABILITY, FITNESS FOR A PARTICULAR PURPOSE (AND THEIR EQUIVALENTS UNDER THE LAWS OF ANY JURISDICTION), OR INFRINGEMENT OF ANY PATENT, COPYRIGHT OR OTHER INTELLECTUAL PROPERTY RIGHT.

UNLESS EXPRESSLY APPROVED IN WRITING BY AN AUTHORIZED ST REPRESENTATIVE, ST PRODUCTS ARE NOT RECOMMENDED, AUTHORIZED OR WARRANTED FOR USE IN MILITARY, AIR CRAFT, SPACE, LIFE SAVING, OR LIFE SUSTAINING APPLICATIONS, NOR IN PRODUCTS OR SYSTEMS WHERE FAILURE OR MALFUNCTION MAY RESULT IN PERSONAL INJURY, DEATH, OR SEVERE PROPERTY OR ENVIRONMENTAL DAMAGE. ST PRODUCTS WHICH ARE NOT SPECIFIED AS "AUTOMOTIVE GRADE" MAY ONLY BE USED IN AUTOMOTIVE APPLICATIONS AT USER'S OWN RISK.

Resale of ST products with provisions different from the statements and/or technical features set forth in this document shall immediately void any warranty granted by ST for the ST product or service described herein and shall not create or extend in any manner whatsoever, any liability of ST.

ST and the ST logo are trademarks or registered trademarks of ST in various countries.

Information in this document supersedes and replaces all information previously supplied.

The ST logo is a registered trademark of STMicroelectronics. All other names are the property of their respective owners.

© 2011 STMicroelectronics - All rights reserved

STMicroelectronics group of companies

Australia - Belgium - Brazil - Canada - China - Czech Republic - Finland - France - Germany - Hong Kong - India - Israel - Italy - Japan - Malaysia - Malta - Morocco - Philippines - Singapore - Spain - Sweden - Switzerland - United Kingdom - United States of America

www.st.com

Компания «Океан Электроники» предлагает заключение долгосрочных отношений при поставках импортных электронных компонентов на взаимовыгодных условиях!

Наши преимущества:

- Поставка оригинальных импортных электронных компонентов напрямую с производств Америки, Европы и Азии, а так же с крупнейших складов мира;
- Широкая линейка поставок активных и пассивных импортных электронных компонентов (более 30 млн. наименований);
- Поставка сложных, дефицитных, либо снятых с производства позиций;
- Оперативные сроки поставки под заказ (от 5 рабочих дней);
- Экспресс доставка в любую точку России;
- Помощь Конструкторского Отдела и консультации квалифицированных инженеров;
- Техническая поддержка проекта, помощь в подборе аналогов, поставка прототипов;
- Поставка электронных компонентов под контролем ВП;
- Система менеджмента качества сертифицирована по Международному стандарту ISO 9001;
- При необходимости вся продукция военного и аэрокосмического назначения проходит испытания и сертификацию в лаборатории (по согласованию с заказчиком);
- Поставка специализированных компонентов военного и аэрокосмического уровня качества (Xilinx, Altera, Analog Devices, Intersil, Interpoint, Microsemi, Actel, Aeroflex, Peregrine, VPT, Syfer, Eurofarad, Texas Instruments, MS Kennedy, Miteq, Cobham, E2V, MA-COM, Hittite, Mini-Circuits, General Dynamics и др.);

Компания «Океан Электроники» является официальным дистрибьютором и эксклюзивным представителем в России одного из крупнейших производителей разъемов военного и аэрокосмического назначения «JONHON», а так же официальным дистрибьютором и эксклюзивным представителем в России производителя высокотехнологичных и надежных решений для передачи СВЧ сигналов «FORSTAR».



JONHON

«JONHON» (основан в 1970 г.)

Разъемы специального, военного и аэрокосмического назначения:

(Применяются в военной, авиационной, аэрокосмической, морской, железнодорожной, горно- и нефтедобывающей отраслях промышленности)

«FORSTAR» (основан в 1998 г.)

ВЧ соединители, коаксиальные кабели, кабельные сборки и микроволновые компоненты:

(Применяются в телекоммуникациях гражданского и специального назначения, в средствах связи, РЛС, а так же военной, авиационной и аэрокосмической отраслях промышленности).



Телефон: 8 (812) 309-75-97 (многоканальный)

Факс: 8 (812) 320-03-32

Электронная почта: ocean@oceanchips.ru

Web: <http://oceanchips.ru/>

Адрес: 198099, г. Санкт-Петербург, ул. Калинина, д. 2, корп. 4, лит. А