

For board-to-FPC	A4US Series
Narrow pitch connectors (0.4mm pitch)	

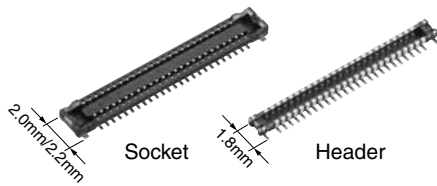

RoHS compliant

FEATURES

1. Slim body width of 2.0 mm/2.2 mm contributes to space-saving.
2. A wide lineup contributes to the design freedom.

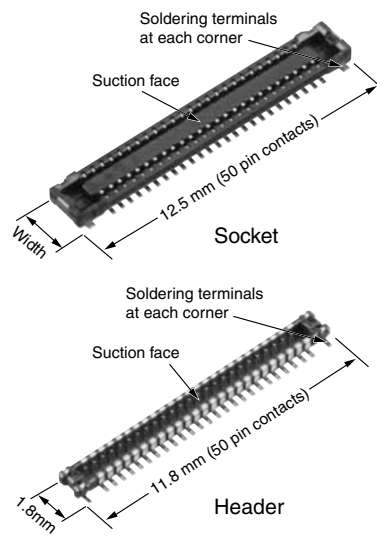

Unit: mm

Width for socket	Mated height		
	0.8	1.0	1.5
2.2	—	☆	☆
2.0 New	☆	—	—
Suction face	Socket	0.6	0.64
	Header	0.7	0.76

3. **“TOUGH CONTACT”** ensures high resistance to various environments in lieu of its space-saving footprint.

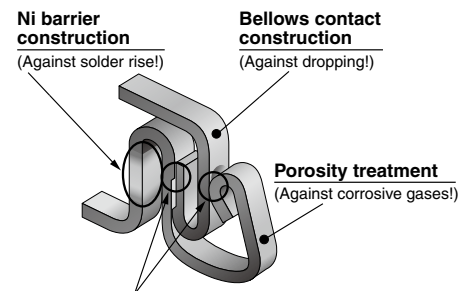

V notch and Double contact constructions
(Against foreign particles and flux!)

4. Simple lock structure provides tactile feedback to ensure excellent mating/unmating operation feel.
5. Soldering terminals at each corner enhance mounting strength.
6. Gull-wing-shaped terminals to facilitate visual inspections.

APPLICATIONS

Suitable for board-to-FPC connections in mobile equipment that requires size and thickness reduction and functionality enhancement.

ORDERING INFORMATION

■ 0.8 mm

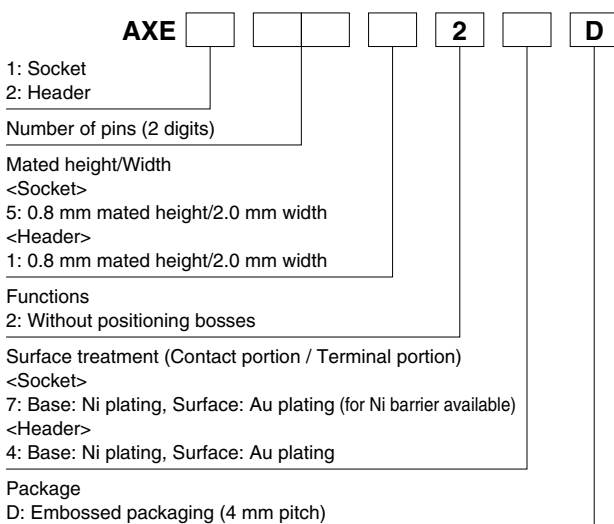

■ 1.0 mm, 1.5 mm

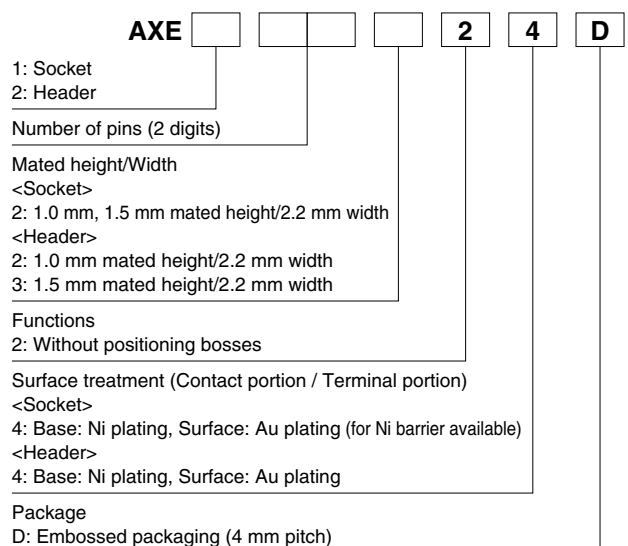

PRODUCT TYPES

Mated height	Number of pins	Part number		Packing	
		Socket	Header	Inner carton (1-reel)	Outer carton
0.8mm	10	AXE110527D	AXE210124D	10,000 pieces	20,000 pieces
	14	AXE114527D	AXE214124D		
	18	AXE118527D	AXE218124D		
	20	AXE120527D	AXE220124D		
	24	AXE124527D	AXE224124D		
	30	AXE130527D	AXE230124D		
	34	AXE134527D	AXE234124D		
	36	AXE136527D	AXE236124D		
	40	AXE140527D	AXE240124D		
	50	AXE150527D	AXE250124D		
	60	AXE160527D	AXE260124D		
1.0mm	70	AXE170527D	AXE270124D		
	80	AXE180527D	AXE280124D		
	10	AXE110224D	AXE210224D		
	20	AXE120224D	AXE220224D		
	34	AXE134224D	AXE234224D		
1.5mm	40	AXE140224D	AXE240224D		
	60	AXE160224D	AXE260224D		
	80	AXE180224D	AXE280224D		
	20	AXE120224D	AXE220324D		
	60	AXE160224D	AXE260324D		
	80	AXE180224D	AXE280324D		

Notes: 1. Order unit:

For volume production: 1-inner carton (1-reel) units

Samples for mounting check: 50-connector units. Please contact our sales office.

Samples: Small lot orders are possible. Please contact our sales office.

2. Please contact us for connectors having a number of pins other than those listed above.

SPECIFICATIONS

1. Characteristics

	Item	Specifications	Conditions		
Electrical characteristics	Rated current	0.30A/pin contact (Max. 5 A at total pin contacts)			
	Rated voltage	60V AC/DC			
	Breakdown voltage	150V AC for 1 min.	No short-circuiting or damage at a detection current of 1 mA when the specified voltage is applied for one minute.		
	Insulation resistance	Min. 1,000M Ω (initial)	Using 250V DC megger (applied for 1 min.)		
	Contact resistance	Max. 90m Ω	Based on the contact resistance measurement method specified by JIS C 5402.		
Mechanical characteristics	Composite insertion force	Max. 0.981N/pin contacts \times pin contacts (initial)			
	Composite removal force	Min. 0.165N/pin contacts \times pin contacts			
	Contact holding force (Socket contact)	Min. 0.20N/pin contacts	Measuring the maximum force. As the contact is axially pull out.		
Environmental characteristics	Ambient temperature	-55°C to +85°C	No freezing at low temperatures. No dew condensation.		
	Soldering heat resistance	Peak temperature: 260°C or less (on the surface of the PC board around the connector terminals)	Infrared reflow soldering		
		300°C within 5 sec. 350°C within 3 sec.	Soldering iron		
	Storage temperature	-55°C to +85°C (product only) -40°C to +50°C (emboss packing)	No freezing at low temperatures. No dew condensation.		
	Thermal shock resistance (header and socket mated)	5 cycles, insulation resistance min. 100M Ω , contact resistance max. 90m Ω	Conformed to MIL-STD-202F, method 107G		
			Order	Temperature (°C)	Time (minutes)
			1	-55 $\frac{3}{3}$	30
2	∩	Max. 5			
3	85 $\frac{3}{3}$	30			
4	∩	Max. 5			
4	-55 $\frac{3}{3}$				
Humidity resistance (header and socket mated)	120 hours, insulation resistance min. 100M Ω , contact resistance max. 90m Ω	Bath temperature 40 \pm 2°C, humidity 90 to 95% R.H.			
Saltwater spray resistance (header and socket mated)	24 hours, insulation resistance min. 100M Ω , contact resistance max. 90m Ω	Bath temperature 35 \pm 2°C, saltwater concentration 5 \pm 1%			
H ₂ S resistance (header and socket mated)	48 hours, contact resistance max. 90m Ω	Bath temperature 40 \pm 2°C, gas concentration 3 \pm 1 ppm, humidity 75 to 80% R.H.			
Lifetime characteristics	Insertion and removal life	30 times	Repeated insertion and removal speed of max. 200 times/hours		
Unit weight	60 pin contacts	Socket (h = 0.8mm: 0.03g, h = 1.0/1.5mm: 0.04g) Header (h = 0.8mm: 0.02g, h = 1.0mm: 0.02g, h = 1.5mm: 0.03g)			

2. Material and surface treatment

Part name	Material	Surface treatment
Molded portion	LCP resin (UL94V-0)	—
Contact and Post	Copper alloy	Contact portion: Base: Ni plating, Surface: Au plating Terminal portion: Base: Ni plating, Surface: Au plating (except the terminal tips) The socket terminals close to the portion to be soldered have nickel barriers (exposed nickel portions). Soldering terminals: Sockets: Base: Ni plating, Surface: Pd+Au flash plating (except the terminal tips) Headers: Base: Ni plating, Surface: Au plating (except the terminal tips)

DIMENSIONS (Unit: mm)

The CAD data of the products with a **CAD Data** mark can be downloaded from: <http://industrial.panasonic.com/ac/e/>

Socket (Mated height: 0.8 mm)

CAD Data

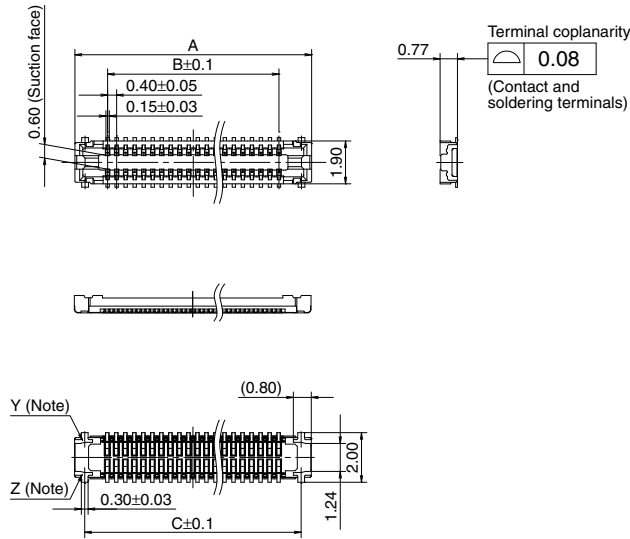
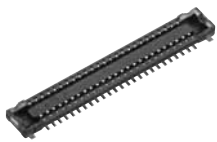

Dimension table (mm)

Number of pins/ dimension	A	B	C
10	4.50	1.60	3.60
14	5.30	2.40	4.40
18	6.10	3.20	5.20
20	6.50	3.60	5.60
24	7.30	4.40	6.40
30	8.50	5.60	7.60
34	9.30	6.40	8.40
36	9.70	6.80	8.80
40	10.50	7.60	9.60
50	12.50	9.60	11.60
60	14.50	11.60	13.60
70	16.50	13.60	15.60
80	18.50	15.60	17.60

General tolerance: ±0.2

Note: Since soldering terminals are built into the body, the Y and Z parts are connected electrically.

Header (Mated height: 0.8 mm)

CAD Data

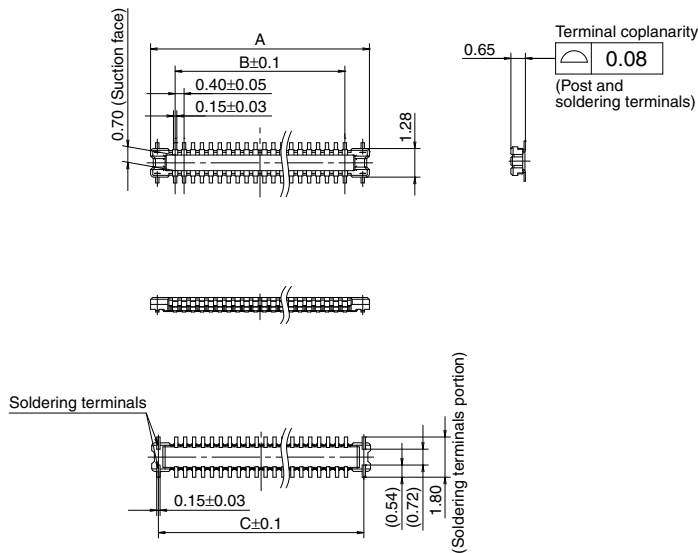

Dimension table (mm)

Number of pins/ dimension	A	B	C
10	3.80	1.60	3.20
14	4.60	2.40	4.00
18	5.40	3.20	4.80
20	5.80	3.60	5.20
24	6.60	4.40	6.00
30	7.80	5.60	7.20
34	8.60	6.40	8.00
36	9.00	6.80	8.40
40	9.80	7.60	9.20
50	11.80	9.60	11.20
60	13.80	11.60	13.20
70	15.80	13.60	15.20
80	17.80	15.60	17.20

General tolerance: ±0.2

Narrow pitch connectors A4US (0.4mm pitch)

Socket (Mated height: 1.0 mm and 1.5 mm)

CAD Data

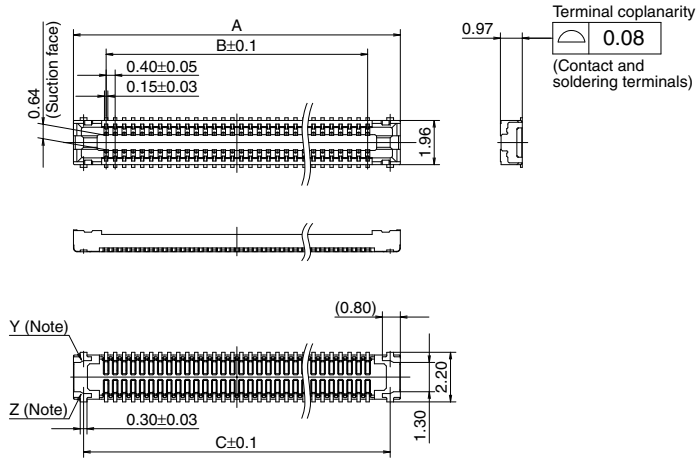

General tolerance: ±0.2

Dimension table (mm)

Number of pins/ dimension	A	B	C
10	4.50	1.60	3.60
20	6.50	3.60	5.60
34	9.30	6.40	8.40
40	10.50	7.60	9.60
60	14.50	11.60	13.60
80	18.50	15.60	17.60

Note: Since soldering terminals are built into the body, the Y and Z parts are connected electrically.

Header (Mated height: 1.0 mm)

CAD Data

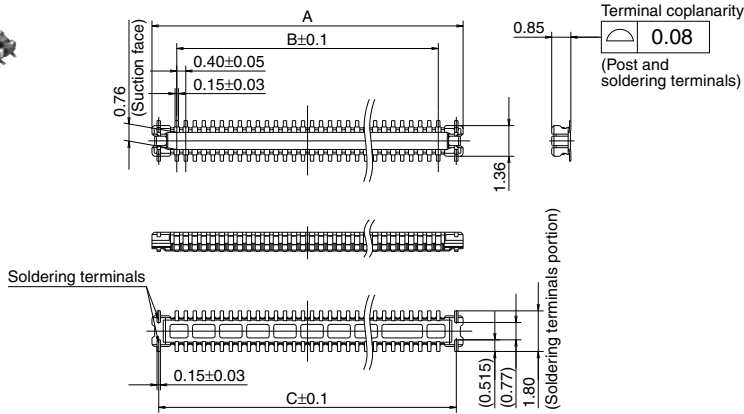

General tolerance: ±0.2

Dimension table (mm)

Number of pins/ dimension	A	B	C
10	3.80	1.60	3.20
20	5.80	3.60	5.20
34	8.60	6.40	8.00
40	9.80	7.60	9.20
60	13.80	11.60	13.20
80	17.80	15.60	17.20

Header (Mated height: 1.5 mm)

CAD Data

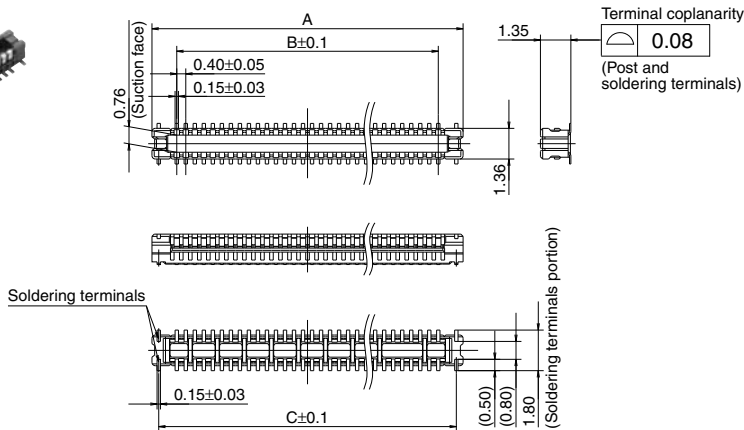

General tolerance: ±0.2

Dimension table (mm)

Number of pins/ dimension	A	B	C
20	5.80	3.60	5.20
60	13.80	11.60	13.20
80	17.80	15.60	17.20

Socket and Header are mated

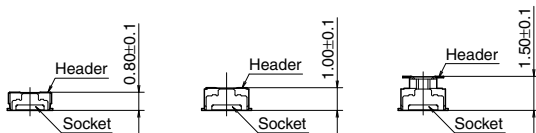

EMBOSSED TAPE DIMENSIONS (Unit: mm)

• Specifications for taping

(In accordance with JIS C 0806-3:1999. However, not applied to the mounting-hole pitch of some connectors.)

• Specifications for the plastic reel

(In accordance with EIAJ ET-7200B.)

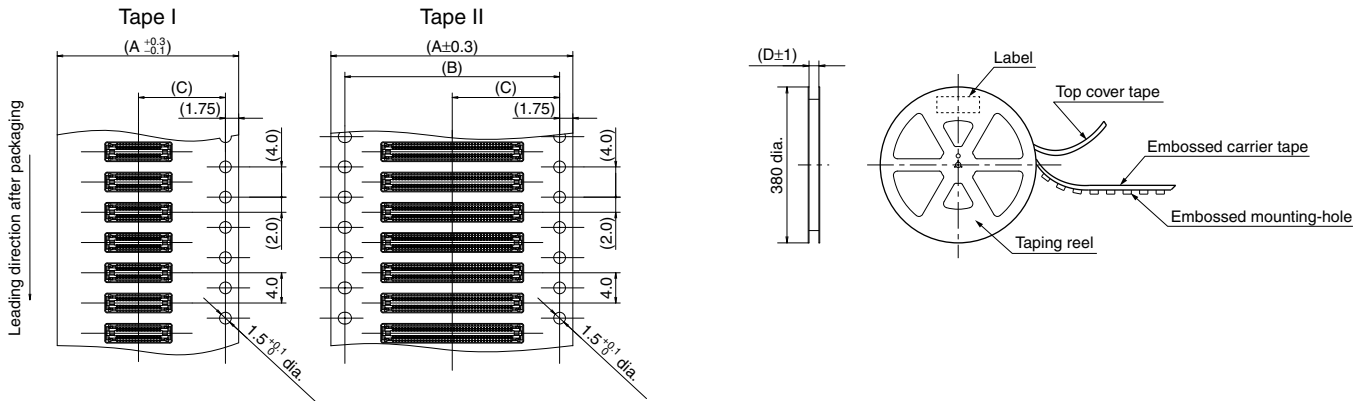

• Dimension table (Unit: mm)

Type/Mated height	Number of pins	Type of taping	A	B	C	D	Quantity per reel
Common for sockets and headers: 0.8mm, 1.0mm and 1.5mm	Max. 24	Tape I	16.0	—	7.5	17.4	10,000
	30 to 60	Tape I	24.0	—	11.5	25.4	10,000
	70, 80	Tape II	32.0	28.4	14.2	33.4	10,000

• Connector orientation with respect to embossed tape feeding direction

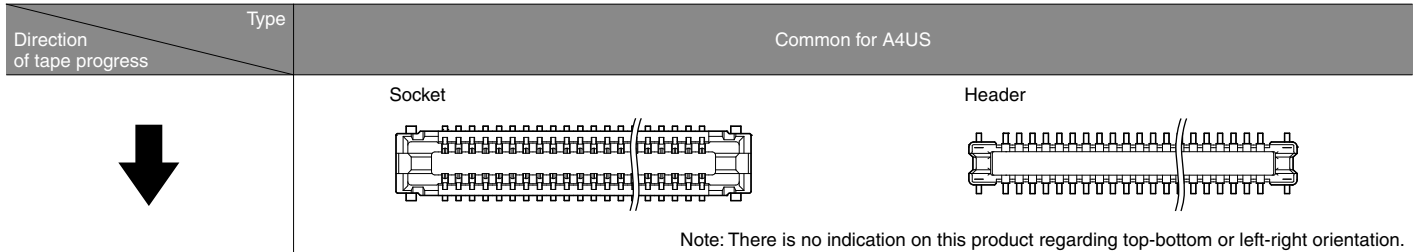

Note: There is no indication on this product regarding top-bottom or left-right orientation.

NOTES

1. Design of PC board patterns

Conduct the recommended foot pattern design, in order to preserve the mechanical strength of terminal solder areas.

2. Recommended PC board and metal mask patterns

Connectors are mounted with high pitch density, intervals of 0.35 mm, 0.4 mm or 0.5 mm.

In order to reduce solder and flux rise, solder bridges and other issues make sure the proper levels of solder is used. The figures to the right are recommended metal mask patterns. Please use them as a reference.

3. See the common "NOTES FOR USE" on the next page for other points to be noted.

• 0.8 mm Socket

Recommended PC board pattern

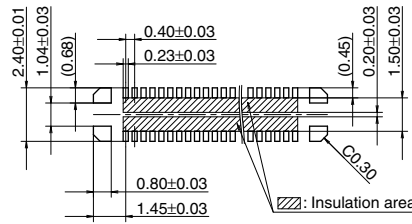

Recommended metal mask pattern

Metal mask thickness: When 100μm
(Terminal opening ratio: 70%)
(Metal-part opening ratio: 100%)

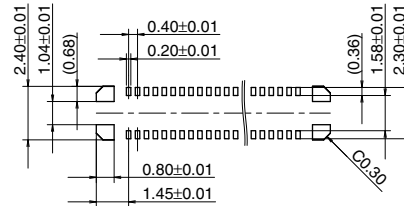

• Header (Mated height: 0.8 mm, 1.0 mm and 1.5 mm)

Recommended PC board pattern (TOP VIEW)

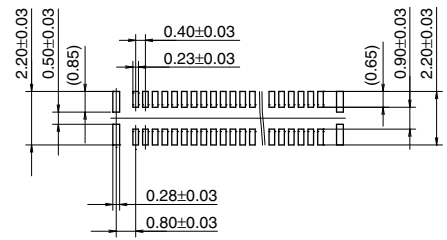

Recommended metal mask pattern

Metal mask thickness: When 120μm
(Terminal opening ratio: 70%)
(Metal-part opening ratio: 73%)

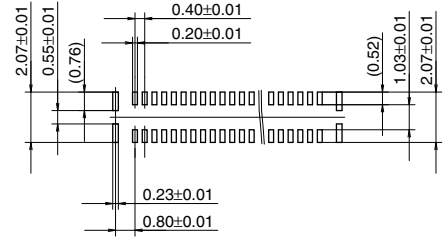

• Socket (Mated height: 1.0 mm and 1.5 mm)

Recommended PC board pattern (TOP VIEW)

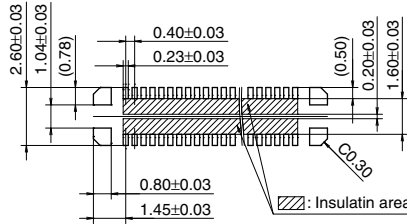

Recommended metal mask pattern

Metal mask thickness: When 120μm
(Terminal opening ratio: 70%)
(Metal-part opening ratio: 100%)

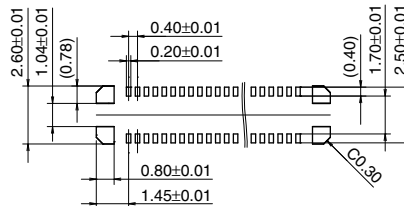

For other details, please verify with the product specification sheets.

Notes on Using Narrow pitch Connectors

Regarding the design of devices and PC board patterns

1) When connecting several connectors together by stacking, make sure to maintain proper accuracy in the design of structure and mounting equipment so that the connectors are not subjected to twisting and torsional forces.

2) With mounting equipment, there may be up to a ± 0.2 to 0.3 -mm error in positioning. Be sure to design PC boards and patterns while taking into consideration the performance and abilities of the required equipment.

3) Some connectors have tabs embossed on the body to aid in positioning. When using these connectors, make sure that the PC board is designed with positioning holes to match these tabs.

4) To ensure the required mechanical strength when soldering the connector terminals, make sure the PC board meets recommended PC board pattern design dimensions given.

5) For all connectors of the narrow pitch series, to prevent the PC board from coming off during vibrations or impacts, and to prevent loads from falling directly on the soldered portions, be sure to design some means to fix the PC board in place.

Example) Secure in place with screws

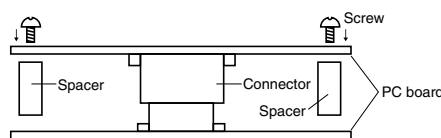

When connecting PC boards, take appropriate measures to prevent the connector from coming off.

6) Notes when using a FPC.

(1) When the connector is soldered to an FPC board, during its insertion and removal procedures, forces may be applied to the terminals and cause the soldering to come off. It is recommended to use a reinforcement board on the

backside of the FPC board to which the connector is being connected. Please make the reinforcement board dimensions bigger than the outer limits of the recommended PC board pattern (should be approximately 1 mm greater than the outer limit).

Material should be glass epoxy or polyimide, and the thickness should be between 0.2 and 0.3 mm.

(2) Collisions, impacts, or turning of FPC boards, may apply forces on the connector and cause it to come loose. Therefore, make to design retaining plates or screws that will fix the connector in place.

7) The narrow pitch connector series is designed to be compact and thin.

Although ease of handling has been taken into account, take care when mating the connectors, as displacement or angled mating could damage or deform the connector.

Regarding the selection of the connector placement machine and the mounting procedures

1) Select the placement machine taking into consideration the connector height, required positioning accuracy, and packaging conditions.

2) Be aware that if the catching force of the placement machine is too great, it may deform the shape of the connector body or connector terminals.

3) Be aware that during mounting, external forces may be applied to the connector contact surfaces and terminals and cause deformations.

4) Depending on the size of the connector being used, self alignment may not be possible. In such cases, be sure to carefully position the terminal with the PC board pattern.

5) The positioning bosses give an approximate alignment for positioning on the PC board. For accurate positioning of the connector when mounting it to the PC board, we recommend using an automatic positioning machine.

6) Excessive moulder chucking force may deform the molded or metal part of the connector. Consult us in advance if chucking is to be applied.

Regarding soldering

1. Reflow soldering

- 1) Measure the recommended profile temperature for reflow soldering by placing a sensor on the PC board near the connector surface or terminals. (The setting for the sensor will differ depending on the sensor used, so be sure to carefully read the instructions that comes with it.)
- 2) As for cream solder printing, screen printing is recommended.
- 3) To determine the relationship between the screen opening area and the PC-board foot pattern area, refer to the diagrams in the recommended patterns for PC boards and metal masks. Make sure to use the terminal tip as a reference position when setting. Avoid an excessive amount of solder from being applied, otherwise, interference by the solder will cause an imperfect contact.

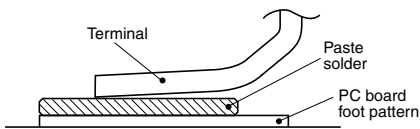

- 4) Consult us when using a screen-printing thickness other than that recommended.
- 5) When mounting on both sides of the PC board and the connector is mounting on the underside, use adhesives or other means to ensure the connector is properly fixed to the PC board. (Double reflow soldering on the same side is possible.)
- 6) N₂ reflow, conducting reflow soldering in a nitrogen atmosphere, increases the solder flow too greatly, enabling wicking to occur. Make sure that the solder feed rate and temperature profile are appropriate.

Soldering conditions

Please use the reflow temperature profile conditions recommended below for reflow soldering. Please contact us before using a temperature profile other than that described below (e.g. lead-free solder).

- Narrow pitch connectors (except P8 type)

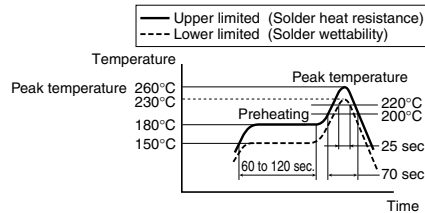

- Narrow pitch connector (P8)

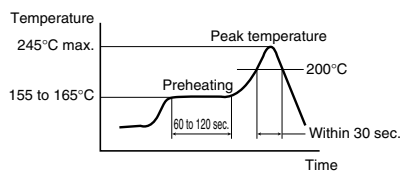

For products other than the ones above, please refer to the latest product specifications.

- 7) The temperatures are measured at the surface of the PC board near the connector terminals. (The setting for the sensor will differ depending on the sensor used, so be sure to carefully read the instructions that comes with it.)
- 8) The temperature profiles given in this catalog are values measured when using the connector on a resin-based PC board. When performed reflow soldering on a metal board (iron, aluminum, etc.) or a metal table to mount on a FPC, make sure there is no deformation or discoloration of the connector beforehand and then begin mounting.
- 9) Consult us when using a screen-printing thickness other than that recommended.
- 10) Some solder and flux types may cause serious solder or flux creeping. Solder and flux characteristics should be taken into consideration when setting the reflow soldering conditions.

2. Hand soldering

- 1) Set the soldering iron so that the tip temperature is less than that given in the table below.

Table A

Product name	Soldering iron temperature
SMD type connectors	300°C within 5 sec. 350°C within 3 sec.

- 2) Do not allow flux to spread onto the connector leads or PC board. This may lead to flux rising up to the connector inside.
- 3) Touch the soldering iron to the foot pattern. After the foot pattern and connector terminal are heated, apply the solder wire so it melts at the end of the connector terminals.

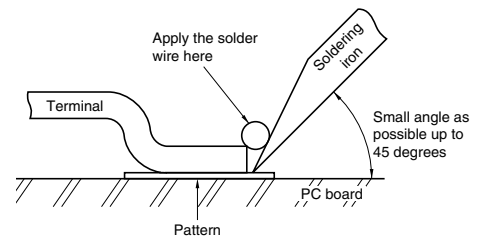

- 4) Be aware that soldering while applying a load on the connector terminals may cause improper operation of the connector.
 - 5) Thoroughly clean the soldering iron.
 - 6) Flux from the solder wire may get on the contact surfaces during soldering operations. After soldering, carefully check the contact surfaces and clean off any solder before use.
 - 7) For soldering of prototype devices during product development, you can perform soldering at the necessary locations by heating with a hot-air gun by applying cream solder to the foot pattern beforehand. However, at this time, make sure that the air pressure does not move connectors by carefully holding them down with tweezers or other similar tool. Also, be careful not to go too close to the connectors and melt any of the molded components.
 - 8) If an excessive amount of solder is applied during manual soldering, the solder may creep up near the contact points, or solder interference may cause imperfect contact.
- ### 3. Solder reworking
- 1) Finish reworking in one operation.
 - 2) For reworking of the solder bridge, use a soldering iron with a flat tip. To prevent flux from climbing up to the contact surfaces, do not add more flux.
 - 3) Keep the soldering iron tip temperature below the temperature given in Table A.

Handling Single Components

- 1) Make sure not to drop or allow parts to fall from work bench
- 2) Excessive force applied to the terminals could cause warping, come out, or weaken the adhesive strength of the solder. Handle with care.
- 3) Repeated bending of the terminals may cause terminals to break.

- 4) Do not insert or remove the connector when it is not soldered. Forcibly applied external pressure on the terminals can weaken the adherence of the terminals to the molded part or cause the terminals to lose their evenness.
- 5) Excessive prying-force applied to one end may cause product breakage and separation of the solder joints at the terminal.

Excessive force applied for insertion in a pivot action as shown may also cause product breakage. Align the header and socket positions before connecting them.

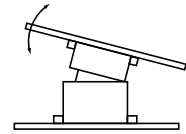

Cleaning flux from PC board

- 1) To increase the cleanliness of the cleaning fluid and cleaning operations, prepare equipment for cleaning process beginning with boil cleaning, ultrasonic cleaning, and then vapor cleaning.
- 2) Carefully oversee the cleanliness of the cleaning fluids to make sure that the contact surfaces do not become dirty from the cleaning fluid itself.

- 3) Since some powerful cleaning solutions may dissolve molded components of the connector and wipe off or discolor printed letters, we recommend aqua pura electronic parts cleaners. Please consult us if you wish to use other types of cleaning fluids.
- 4) Please note that the surfaces of molded parts may whiten when cleaned with alcohol.

Handling the PC board

- **Handling the PC board after mounting the connector**
- When cutting or bending the PC board after mounting the connector, be careful that the soldered sections are subjected to excessive force.

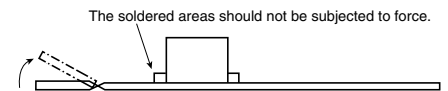

Storage of connectors

- 1) To prevent problems from voids or air pockets due to heat of reflow soldering, avoid storing the connectors in areas of high humidity. When storing the connectors for more than six months, be sure to consider storage area where the humidity is properly controlled.
- 2) Depending on the connector type, the color of the connector may vary from connector to connector depending on when it is produced.

- Some connectors may change color slightly if subjected to ultraviolet rays during storage. This is normal and will not affect the operation of the connector.
- 3) When storing the connectors with the PC boards assembled and components already set, be careful not to stack them up so the connectors are subjected to excessive forces.

- 4) Avoid storing the connectors in locations with excessive dust. The dust may accumulate and cause improper connections at the contact surfaces.

Other Notes

- 1) These products are made for the design of compact and lightweight devices and therefore the thickness of the molded components has been made very thin. Therefore, be careful during insertion and removal operations for excessive forces applied may damage the products.
- 2) Dropping of the products or rough mishandling may bend or damage the terminals and possibly hinder proper reflow soldering.

- 3) Before soldering, try not to insert or remove the connector more than absolutely necessary.
- 4) When coating the PC board after soldering the connector to prevent the deterioration of insulation, perform the coating in such a way so that the coating does not get on the connector.
- 5) There may be variations in the colors of products from different production lots. This is normal.

- 6) The connectors are not meant to be used for switching.
- 7) Be sure not to allow external pressure to act on connectors when assembling PCBs or moving in block assemblies.

Regarding sample orders to confirm proper mounting

When ordering samples to confirm proper mounting with the placement machine, connectors are delivered in 50-piece units in the condition given right. Consult a sale representative for ordering sample units.

Condition when delivered from manufacturing



Embossed tape amount required for the mounting

Required number of products for sample production (Unit 50 pcs.)

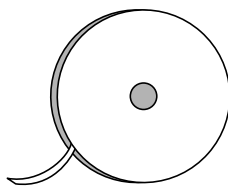

Reel

(Delivery can also be made on a reel by customer request.)

Please refer to the latest product specifications when designing your product.

Mouser Electronics

Authorized Distributor

Click to View Pricing, Inventory, Delivery & Lifecycle Information:

Panasonic:

[AXE150527D](#) [AXE136527D](#) [AXE134527D](#) [AXE180527D](#) [AXE240124D](#) [AXE170527D](#) [AXE120527D](#) [AXE270124D](#)
[AXE280124D](#) [AXE110527D](#) [AXE140527D](#) [AXE214124D](#) [AXE260124D](#) [AXE230124D](#) [AXE160527D](#) [AXE210124D](#)
[AXE218124D](#) [AXE224124D](#) [AXE250124D](#) [AXE234124D](#) [AXE236124D](#) [AXE130527D](#) [AXE220124D](#) [AXE118527D](#)
[AXE114527D](#) [AXE124527D](#) [AXE130124](#) [AXE230124](#) [AXE220124](#) [AXE110044D](#) [AXE214124](#) [AXE270124](#)
[AXE124124](#) [AXE150124](#) [AXE136124](#) [AXE120124](#) [AXE210124](#) [AXE110124](#) [AXE280124](#) [AXE240124](#)
[AXE150044D](#) [AXE170124](#) [AXE160124](#) [AXE250124](#) [AXE260124](#) [AXE236124](#) [AXE224124](#) [AXE140124](#)
[AXE114124](#) [AXE120527](#)

Компания «Океан Электроники» предлагает заключение долгосрочных отношений при поставках импортных электронных компонентов на взаимовыгодных условиях!

Наши преимущества:

- Поставка оригинальных импортных электронных компонентов напрямую с производств Америки, Европы и Азии, а так же с крупнейших складов мира;
- Широкая линейка поставок активных и пассивных импортных электронных компонентов (более 30 млн. наименований);
- Поставка сложных, дефицитных, либо снятых с производства позиций;
- Оперативные сроки поставки под заказ (от 5 рабочих дней);
- Экспресс доставка в любую точку России;
- Помощь Конструкторского Отдела и консультации квалифицированных инженеров;
- Техническая поддержка проекта, помощь в подборе аналогов, поставка прототипов;
- Поставка электронных компонентов под контролем ВП;
- Система менеджмента качества сертифицирована по Международному стандарту ISO 9001;
- При необходимости вся продукция военного и аэрокосмического назначения проходит испытания и сертификацию в лаборатории (по согласованию с заказчиком);
- Поставка специализированных компонентов военного и аэрокосмического уровня качества (Xilinx, Altera, Analog Devices, Intersil, Interpoint, Microsemi, Actel, Aeroflex, Peregrine, VPT, Syfer, Eurofarad, Texas Instruments, MS Kennedy, Miteq, Cobham, E2V, MA-COM, Hittite, Mini-Circuits, General Dynamics и др.);

Компания «Океан Электроники» является официальным дистрибьютором и эксклюзивным представителем в России одного из крупнейших производителей разъемов военного и аэрокосмического назначения «**JONHON**», а так же официальным дистрибьютором и эксклюзивным представителем в России производителя высокотехнологичных и надежных решений для передачи СВЧ сигналов «**FORSTAR**».



JONHON

«**JONHON**» (основан в 1970 г.)

Разъемы специального, военного и аэрокосмического назначения:

(Применяются в военной, авиационной, аэрокосмической, морской, железнодорожной, горно- и нефтедобывающей отраслях промышленности)

«**FORSTAR**» (основан в 1998 г.)

ВЧ соединители, коаксиальные кабели,
кабельные сборки и микроволновые компоненты:

(Применяются в телекоммуникациях гражданского и специального назначения, в средствах связи, РЛС, а так же военной, авиационной и аэрокосмической отраслях промышленности).



Телефон: 8 (812) 309-75-97 (многоканальный)

Факс: 8 (812) 320-03-32

Электронная почта: ocean@oceanchips.ru

Web: <http://oceanchips.ru/>

Адрес: 198099, г. Санкт-Петербург, ул. Калинина, д. 2, корп. 4, лит. А