

Precision SMD TCXO/VCTCXO

AST3TQ53



ESD Sensitive



RoHS/RoHS II Compliant



5.0 x 3.2 x 2.0mm

Moisture Sensitivity Level (MSL) – 3

FEATURES:

- Standard available frequencies: 10.00, 12.80, 16.384, 19.20, 19.44, 20.00, 24.576, 25.00, 26.00, 30.72, 40.00 MHz
- LVC MOS Output or Clipped Sine Wave output
- Frequency stabilities to include ± 50 ppb, ± 100 ppb and ± 280 ppb over -40°C to $+85^{\circ}\text{C}$ operating temperature range
- Excellent Phase Noise, Harmonics and Spurious content
- Typical rms jitter of 400fs @ 40MHz carrier & 1.0ps @ 10MHz carrier over 12kHz to 20MHz BW

APPLICATIONS:

- COTS Military Radios & other Communication Hardware
- WiMax,
- LTE, BTS
- CATV, LAN, LMDS
- GPS Tracking with Hold-Over accuracy
- Test & Measurement Equipment
- Point-to-Point communication networks

STANDARD SPECIFICATIONS:

Maximum Rating

Parameters	Rating
Storage Temperature Range	-55 to +125°C
Supply Voltage	-0.5 to 6V
Control Voltage	0 to 3V
ESD, HBM/CDM/MM	4kV/2kV/200V

Key Electrical Specifications

Parameters	Minimum	Typical	Maximum	Units	Notes
Frequency Range	10		40	MHz	
Standard Frequencies	10.00, 12.80, 16.384, 19.20, 19.44, 20.00, 24.576, 25.00, 26.00, 30.72, 40.00			MHz	
Initial Frequency Tolerance (@+25°C) at shipping			± 0.5	ppm	Relative to carrier
Frequency Stability Options (Ref. to Frequency @+25°C)					
-40°C to +85°C			± 50	ppb	Option "5"
-40°C to +85°C			± 100	ppb	Option "1"
-40°C to +85°C			± 280	ppb	Option "2"
Frequency Stability vs. Supply Voltage Change (Vdd $\pm 5\%$)			± 100	ppb	
Frequency Stability vs. Load Change (Load $\pm 5\%$)			± 200	ppb	
Aging (first year @+25°C)			± 1.0	ppm	
Aging (20 years @+25°C)		± 3.0	± 4.6	ppm	
Supply Voltage (Vdd)	+3.135	+3.3	+3.465	V	
Supply Current (Icc)			6.0	mA	No load
Control Port (Applicable for VCTCXO only)					
Control Voltage Range (Vc)	+0.5	+1.5	+2.5	V	
Center Control Voltage (Vc)		+1.5		V	To be with-in ± 500 ppb of Fc @ 25°C (at shipping)
Frequency Tuning Range	± 5	± 7	$< \pm 13$	ppm	
Tuning Slope	Positive				
Linearity			± 1	%	
Port Impedance	100			k Ω	

Precision SMD TCXO/VCTCXO

AST3TQ53



ESD Sensitive



RoHS/RoHS II Compliant



5.0 x 3.2 x 2.0mm

STANDARD SPECIFICATIONS:

(Continued)

Parameters	Minimum	Typical	Maximum	Unites	Notes
Phase Noise (10MHz carrier frequency @25°C):			-95	dBc/Hz	Offset @10Hz
			-120		Offset @100Hz
			-140		Offset @1kHz
			-145		Offset @10kHz
			-150		Offset @100kHz
RMS Jitter (@12kHz~5MHz BW)	0.4		1.3	ps	Carrier Dependent
Clipped Sine Wave					
Output Level	0.8			Vp-p	
Output Load	10kΩ//10pF				
LVC MOS Output (Square Wave)					
V _{OH}	2.4			V	Output Load=15pF
V _{OL}			0.4	V	Output Load=15pF
Output Load			15	pF	
Duty Cycle	45		55	%	@(V _{OH} - V _{OL})/2
Rise/Fall Time			6	ns	Output Load=15pF

PART IDENTIFICATION:





AST3TQ53



ESD Sensitive



RoHS/RoHS II Compliant

5.0 x 3.2 x 2.0mm

TYPICAL FREQUENCY STABILITY VS. TEMPERATURE



TYPICAL SHORT TERM STABILITY





TYPICAL FREQUENCY PULL VS. CONTROL VOLTAGE



TYPICAL PHASE NOISE

10.00 MHz Carrier



Precision SMD TCXO/VCTCXO

AST3TQ53



ESD Sensitive



RoHS/RoHS II Compliant

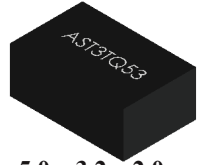

5.0 x 3.2 x 2.0mm

TYPICAL AGING:

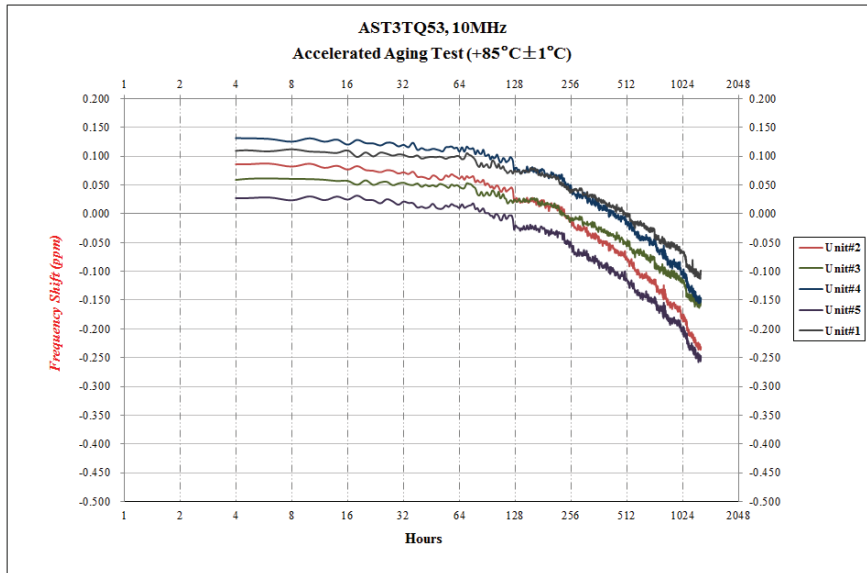

Aging Test Conditions	
Series	AST3TQ53
Frequency	10MHz
Acquisition Mode	Cycle
Acquisition Time	1129 hours
Test Temperature	+85°C ± 1°C
Number of Samples	5pcs

Aging Data			
No.	Aging Time (hrs)	Aging/Day (ppm)	Projected Aging/year (ppm)
#1	1129	-0.0039	-0.3896
#2	1129	-0.0059	-0.5925
#3	1129	-0.0042	-0.4202
#4	1129	-0.0056	-0.5555
#5	1129	-0.0055	-0.5492

OUTLINE DIMENSION:

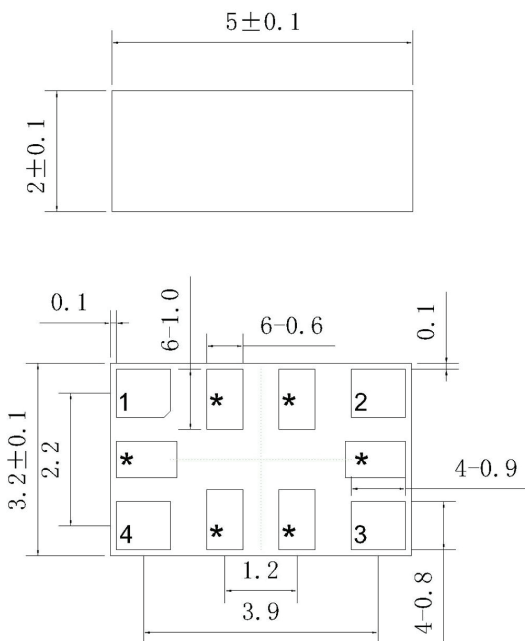

Dimensions: mm

Recommended Land Pattern



Pin	Function
1	NC (for TCXO) Vc (for VCTCXO)
2	GND
3	Output
4	Vdd
*	For factory test only

ABRACON IS
ISO9001:2008
CERTIFIED



2 Faraday, Suite# B | Irvine | CA 92618 Revised: 04.02.15

Ph. 949.546.8000 | Fax. 949.546.8001

Visit www.abracon.com for Terms and Conditions of Sale

Precision SMD TCXO/VCTCXO



5.0 x 3.2 x 2.0mm

AST3TQ53



ESD Sensitive



RoHS/RoHS II Compliant

REFLOW PROFILE:

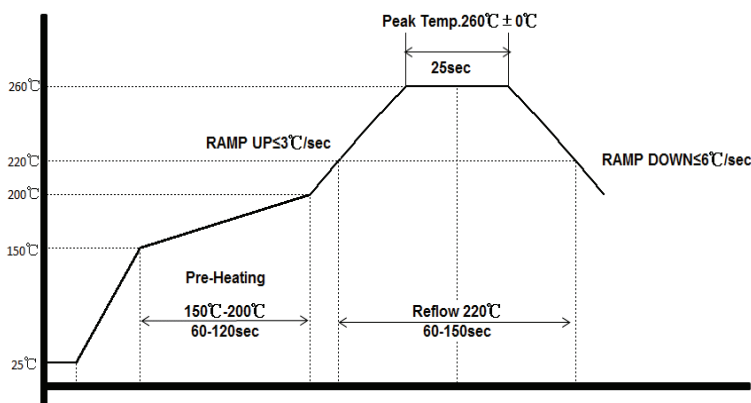

TAPE & REEL:

T5: 500pcs/reel; T2: 2000pcs/reel

MSL-3 packaging applies to MOQ=25 units (cut tape), T5 & T2.

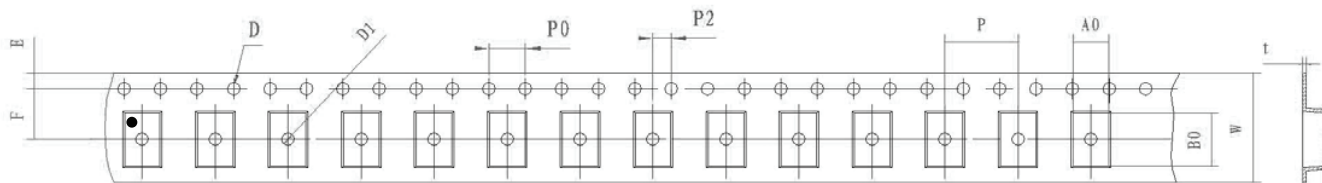

W	A0	B0	K0	P	F
16.0±0.3	3.7±0.15	5.6±0.15	2.0±0.15	8.0±0.1	7.5±0.1
E	D	D1	P0	P2	t
1.75±0.1	1.5+0.1/-0.0	1.5+0.1/-0.0	4.0±0.1	2.0±0.1	0.3±0.05



B-B

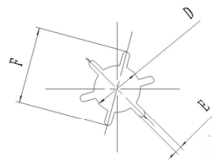
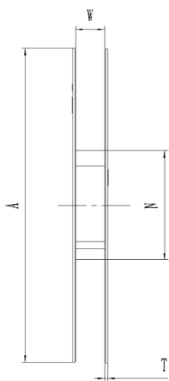
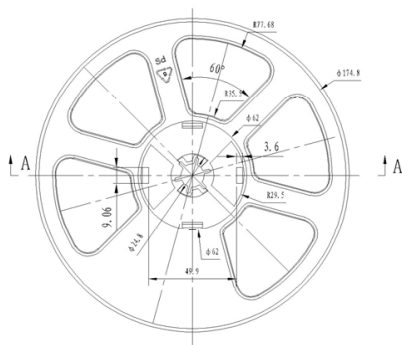

W	A	N	T	E	F	D
16.4±0.3	178±0.5	62±0.4	1.8±0.2	2.0±0.5	21.8±0.8	13.5±0.3

Dimensions: mm

ATTENTION: Abracon Corporation's products are COTS – Commercial-Off-The-Shelf products; suitable for Commercial, Industrial and, where designated, Automotive Applications. Abracon's products are not specifically designed for Military, Aviation, Aerospace, Life-dependant Medical applications or any application requiring high reliability where component failure could result in loss of life and/or property. For applications requiring high reliability and/or presenting an extreme operating environment, written consent and authorization from Abracon Corporation is required. Please contact Abracon Corporation for more information.

ABRACON IS
ISO9001:2008
CERTIFIED



2 Faraday, Suite# B | Irvine | CA 92618 **Revised: 04.02.15**

Ph. 949.546.8000 | Fax. 949.546.8001

Visit www.abracon.com for Terms and Conditions of Sale

Компания «Океан Электроники» предлагает заключение долгосрочных отношений при поставках импортных электронных компонентов на взаимовыгодных условиях!

Наши преимущества:

- Поставка оригинальных импортных электронных компонентов напрямую с производств Америки, Европы и Азии, а так же с крупнейших складов мира;
- Широкая линейка поставок активных и пассивных импортных электронных компонентов (более 30 млн. наименований);
- Поставка сложных, дефицитных, либо снятых с производства позиций;
- Оперативные сроки поставки под заказ (от 5 рабочих дней);
- Экспресс доставка в любую точку России;
- Помощь Конструкторского Отдела и консультации квалифицированных инженеров;
- Техническая поддержка проекта, помощь в подборе аналогов, поставка прототипов;
- Поставка электронных компонентов под контролем ВП;
- Система менеджмента качества сертифицирована по Международному стандарту ISO 9001;
- При необходимости вся продукция военного и аэрокосмического назначения проходит испытания и сертификацию в лаборатории (по согласованию с заказчиком);
- Поставка специализированных компонентов военного и аэрокосмического уровня качества (Xilinx, Altera, Analog Devices, Intersil, Interpoint, Microsemi, Actel, Aeroflex, Peregrine, VPT, Syfer, Eurofarad, Texas Instruments, MS Kennedy, Miteq, Cobham, E2V, MA-COM, Hittite, Mini-Circuits, General Dynamics и др.);

Компания «Океан Электроники» является официальным дистрибьютором и эксклюзивным представителем в России одного из крупнейших производителей разъемов военного и аэрокосмического назначения «JONHON», а так же официальным дистрибьютором и эксклюзивным представителем в России производителя высокотехнологичных и надежных решений для передачи СВЧ сигналов «FORSTAR».



JONHON

«JONHON» (основан в 1970 г.)

Разъемы специального, военного и аэрокосмического назначения:

(Применяются в военной, авиационной, аэрокосмической, морской, железнодорожной, горно- и нефтедобывающей отраслях промышленности)

«FORSTAR» (основан в 1998 г.)

ВЧ соединители, коаксиальные кабели, кабельные сборки и микроволновые компоненты:

(Применяются в телекоммуникациях гражданского и специального назначения, в средствах связи, РЛС, а так же военной, авиационной и аэрокосмической отраслях промышленности).



Телефон: 8 (812) 309-75-97 (многоканальный)

Факс: 8 (812) 320-03-32

Электронная почта: ocean@oceanchips.ru

Web: <http://oceanchips.ru/>

Адрес: 198099, г. Санкт-Петербург, ул. Калинина, д. 2, корп. 4, лит. А