

LTC2955

Pushbutton On/Off Controller with Automatic Turn-On

DESCRIPTION

Demonstration circuit 1836A-A and 1836A-B feature the LTC[®]2955-1 and LTC2995-2, respectively. The LTC2955 is a micropower, pushbutton on/off controller that manages system power by generating a clean enable output from the supply monitor input and the debounced pushbutton input. It features an interrupt output that notifies the system of a pushbutton event or low level at the ON pin.

When the system receives an $\overline{\text{INT}}$ signal, it may use the power kill input to shut off power. If the pushbutton remains pressed for more than the configurable turn-off duration (3s or 32ms), the system power is forced off.

Design files for this circuit board are available at <http://www.linear.com/demo>

LT, LT, LTC, LTM, Linear Technology and the Linear logo are registered trademarks of Linear Technology Corporation. All other trademarks are the property of their respective owners.

BOARD PHOTO

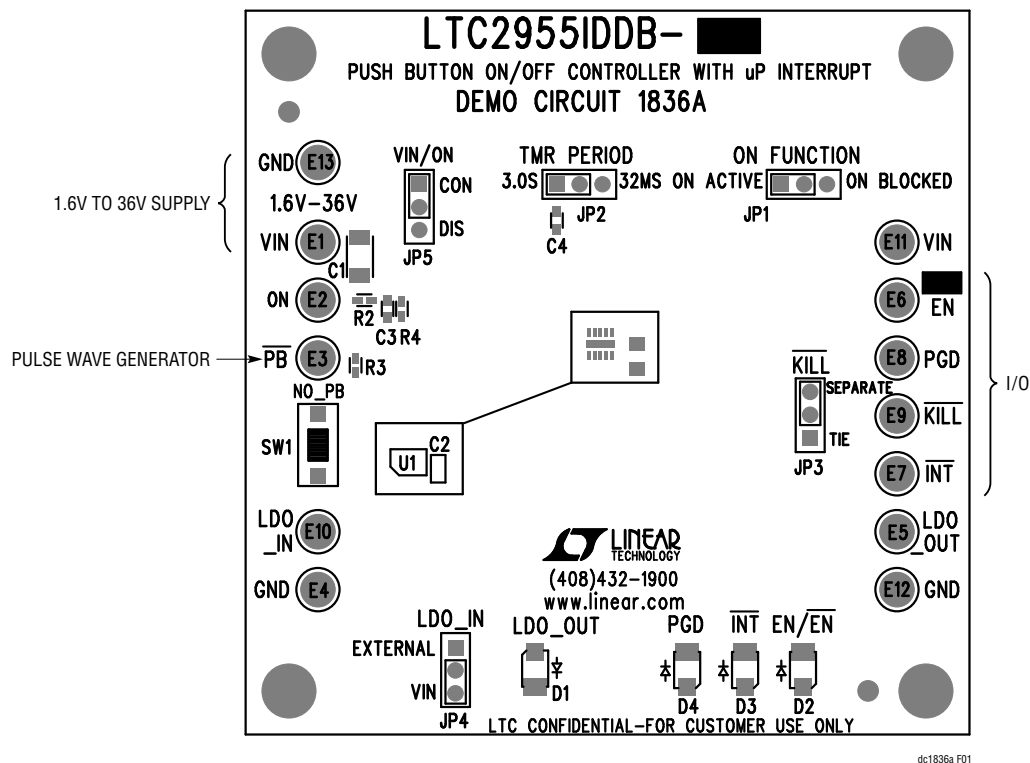

Figure 1. Proper Test Equipment Setup

HARDWARE SETUP

JUMPER SETTINGS

TMR PERIOD: Sets the amount of time the user has to hold down the pushbutton in order to cause a shutdown event. It can either be set to 32ms or 3 seconds.

ON FUNCTION: Connect to ON BLOCKED to block the ON pin falling edge from activating system turn-off. Connect to ON ACTIVE to allow both the ON pin rising and falling edges to activate system turn-on and turn-off, respectively.

VIN/ON: Connects or disconnects VIN from ON. Unless external circuitry has been connected to ON, for ON to function correctly, this should be set to ON.

KILL: Ties or separates $\overline{\text{INT}}$ from $\overline{\text{KILL}}$. Set to TIE for automatic shutdown when a long press on the pushbutton is detected.

LDO_IN: Chooses the input to the onboard LT3060 regulator. The user can either set it to VIN to have it connected to the VIN pin or EXTERNAL in order to have it driven by the LDO_IN turret. See the Operating Principles section. Only for LED/monitor circuitry.

EXTERNAL CONNECTIONS

Signal connections are made via the row of turret posts along the edges of the board.

GND: (3 turrets) These turrets are connected directly to the ground planes.

VIN: Connect a 1.6V to 36V power supply to this turret.

ON: Can be linked to VIN through the VIN/ON jumper, however, can also be externally connected to a power source. Is connected directly to the ON pin of the LTC2955. If the ON function jumper is set to active, this pin can be used to turn on the EN pin, or turn off the $\overline{\text{EN}}$ pin, depending on if the demo board is populated with an LTC2955-1 or LTC2955-2.

PB: This pin is already driven by the pushbutton, however, if needed it can be driven by an external signal to simulate a pushbutton press.

LDO_IN: Can be used to provide the LT3060 with power when the LDO_IN jumper is set to external.

LDO_OUT: Output from the LT3060. The state of this can also be monitored at D1.

DIGITAL CONNECTIONS

EN/ $\overline{\text{EN}}$: Active high (LTC2955-1), or active low (LTC2955-2) signal. Should go active either on a valid ON signal or with a debounced PB press.

$\overline{\text{INT}}$: Goes low on a pushbutton press when EN/ $\overline{\text{EN}}$ is active. Can be tied to KILL to turn off the part.

$\overline{\text{KILL}}$: A low signal at this input will disable EN/ $\overline{\text{EN}}$. The TMR period jumper sets how long the input signal must be held low.

PGD: Power good output from the LTC2955. This pin indicates the status of the ON pin in order to let the system differentiate between pushbutton turn-on and supply button turn-on events.

OPERATING PRINCIPLES

Connect a 1.6V to 36V power supply to VIN. If VIN is less than 5.5V, set the LDO_IN jumper to EXTERNAL and connect a 5.5V to 36V supply to the LDO_IN turret. The LTC2955 will still operate with no power applied to LDO_IN, but monitor LEDs will not function.

On the DC1836A, a pushbutton switch shorts the \overline{PB} pin to ground which in turn sets the \overline{EN} pin low (DC1836A-B) or the EN pin high (DC1836A-A). Shorting \overline{PB} to ground a second time and holding (duration depending on the TMR_PERIOD jumper) subsequently de-asserts the EN/ \overline{EN} pin. The EN/ \overline{EN} pin is unobtrusively monitored by the LT6700 comparator.

An internal 512ms timer blanks (ignores) the \overline{KILL} signal during system power-up. This allows sufficient time for the DC/DC converter and a controller to perform power-up tasks.

A high to low transition on \overline{PB} starts the turn-off sequence. In order to assert \overline{INT} low, \overline{PB} must stay low continuously for 32ms. Users can also force the system to power down by holding the pushbutton down for a long period; this period is set using the TMR_PERIOD jumper on the board. After the EN/ \overline{EN} pin has been released, the LTC2955 starts a one second lockout time. During this lockout time, the \overline{PB} and ON inputs are ignored—this is meant to allow the voltage regulator to turn off and for its output to decay to 0V.

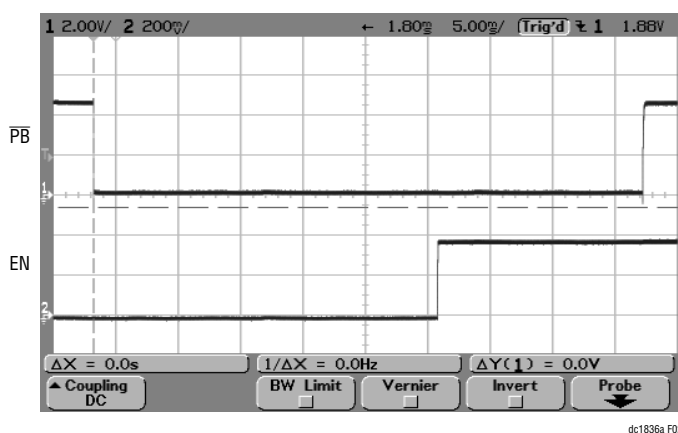

Figure 2. \overline{PB} Going Low For 46.1ms, and EN Pulling High, Showing a Proper Turn-On Sequence

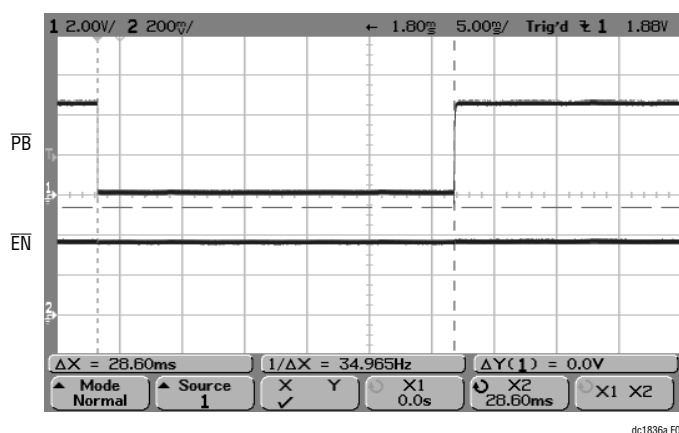

Figure 3. \overline{PB} Going Low for 28.6ms, and \overline{EN} Remaining High, Showing Too Short of a \overline{PB} Pulse to Properly Activate the Enable Pin

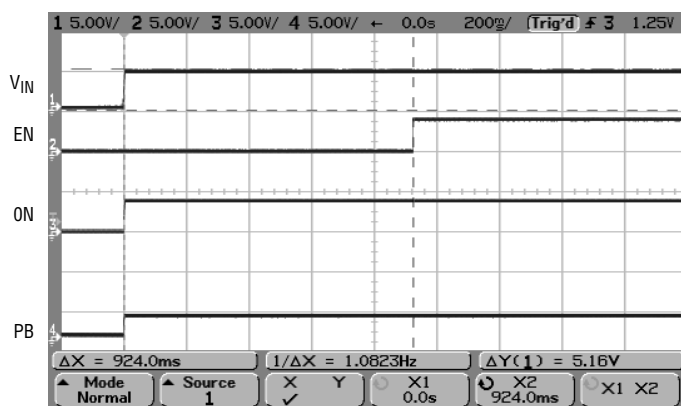

Figure 4. A Turn-On Sequence Where V_{IN} and ON Activate EN, as Opposed to PB. Notice the 924ms Delay Between V_{IN} Going High and EN Activating

DEMO MANUAL DC1836A

PARTS LIST

ITEM	QTY	REFERENCE	PART DESCRIPTION	MANUFACTURER/PART NUMBER
Required Circuit Components				
1	0	C1	CAP, OPT, 1206	
2	1	C2	CAP, X7R, 0.1µF, 50V, 10%, 0805	AVX, 08055C104KAT2A
3	0	C3, C7	CAP, OPT, 0603	
4	1	C4	CAP, X5R, 0.47µF, 10V, 10%, 0603	TAIYO YUDEN, LMK107BJ474KA
5	1	C5	CAP, X5R, 1µF, 10V, 10%, 0603	AVX, 0603ZD105KAT2A
6	1	C6	CAP, X7R 10nF 10V, 10%, 0603	AVX, 0603ZC103KAT2A
7	1	C8	CAP, X5R, 2.2µF, 10V, 10%, 0603	MURATA, GRM188R61A225K
8	1	C9	CAP, X5R, 0.1µF, 10V, 10%, 0603	AVX, 0603ZD104KAT2A
9	13	E1-E13	TP, TURRET, 0.064", PAD120-064	MILL-MAX, 2308-2-00-80-00-00-07-0
10	5	JP1-JP5	HD1×3-079	SAMTEC, TMM103-02-L-S
11	5	XJP1-XJP5	SHUNT	SAMTEC, 2SN-BK-G
12	2	D1, D2	LED, GREEN	PANASONIC, LN1351-C-TR
13	1	D3	LED, RED	PANASONIC, LN1251-C-TR
14	1	D4	LED, AMBER	PANASONIC, LN1451-C-TR
15	1	R1	RES., CHIP, 1k, 1/10W, 1%, 0603	VISHAY, CRCW06031K00FKEA
16	2	R2, R4	RES., CHIP, 200k, 1/16W, 1%, 0402	VISHAY, CRCW0402200KFKED
17	1	R3	RES., CHIP, 5.1k, 1/16W, 1%, 0402	VISHAY, CRCW04025K10FKED
18	0	R5, R7	RES., OPT., 0402	
19	1	R8	RES., CHIP, 100k, 1/16W, 1%, 0402	VISHAY, CRCW0402100KFKED
20	1	R9	RES., CHIP, 845k, 1/16W, 1%, 0402	VISHAY, CRCW0402845KFKED
21	1	R10	RES., CHIP, 115k, 1/16W, 1%, 0402	VISHAY, CRCW0402115KFKED
22	4	R11, R12, R13, R14	RES., CHIP, 475, 1/16W, 1%, 0402	VISHAY, CRCW0402475RFKED
23	2	R6, R19	RES., CHIP, 10k, 1/16W, 1%, 0402	VISHAY, CRCW040210KFKED
24	1	SW1	SWITCH, PUSHBUTTON	PANASONIC, EVQPS05K
25	1	U3	I.C., LT3060ETS8, TS8	LINEAR TECHNOLOGY, LT3060ETS8
26	2	U6, U7	I.C., LT6700CS6-1, SOT23-6	LINEAR TECHNOLOGY, LT6700CS6-1
27	2		STENCIL TOP AND BOTTOM	STENCIL, DC1836A
DC1836A-A Required Circuit Components				
1	1	U1	I.C., LTC2955IDDB-1, DFN10DDB	LINEAR TECHNOLOGY, LTC2955IDDB-1
2	2	R15, R16	Res., Chip, 100k, 1/16W, 1%, 0402	VISHAY, CRCW0402100KFKED
3	0	R17, R18	Res., OPT., 0402	
4	1		FAB, PRINTED CIRCUIT BOARD	DEMO CIRCUIT 1836A
DC1836A-B Required Circuit Components				
1	1	U1	I.C., LTC2955IDDB-2, DFN10DDB	LINEAR TECHNOLOGY, LTC2955IDDB-2
2	2	R17, R18	Res., Chip, 100k, 1/16W, 1%, 0402	VISHAY, CRCW0402100KFKED
3	0	R15, R16	Res., OPT., 0402	
4	1		FAB, PRINTED CIRCUIT BOARD	DEMO CIRCUIT 1836A

SCHEMATIC DIAGRAM

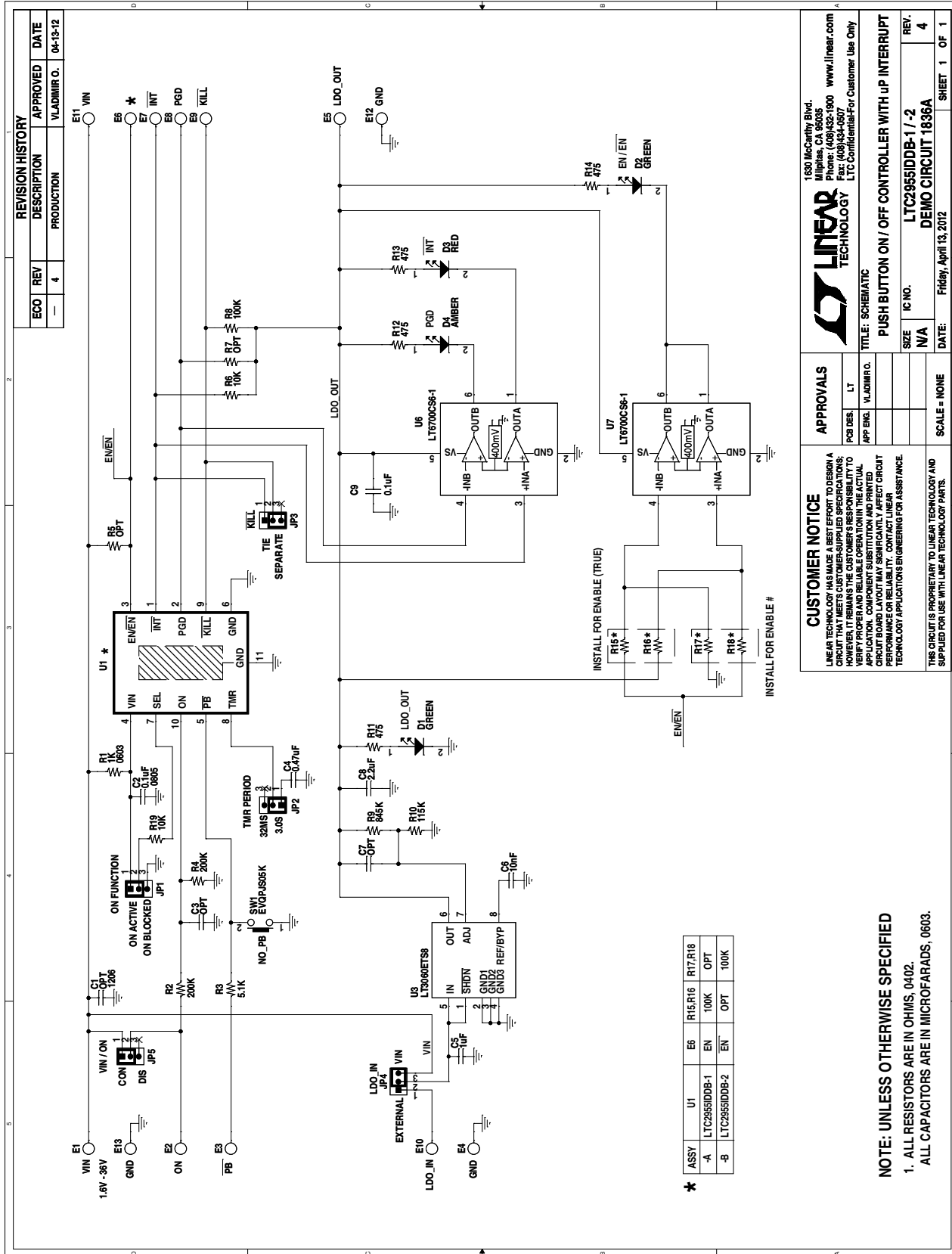

Figure 5. Pushbutton On/Off Controller with µP Interrupt

DEMO MANUAL DC1836A

DEMONSTRATION BOARD IMPORTANT NOTICE

Linear Technology Corporation (LTC) provides the enclosed product(s) under the following **AS IS** conditions:

This demonstration board (DEMO BOARD) kit being sold or provided by Linear Technology is intended for use for **ENGINEERING DEVELOPMENT OR EVALUATION PURPOSES ONLY** and is not provided by LTC for commercial use. As such, the DEMO BOARD herein may not be complete in terms of required design-, marketing-, and/or manufacturing-related protective considerations, including but not limited to product safety measures typically found in finished commercial goods. As a prototype, this product does not fall within the scope of the European Union directive on electromagnetic compatibility and therefore may or may not meet the technical requirements of the directive, or other regulations.

If this evaluation kit does not meet the specifications recited in the DEMO BOARD manual the kit may be returned within 30 days from the date of delivery for a full refund. **THE FOREGOING WARRANTY IS THE EXCLUSIVE WARRANTY MADE BY THE SELLER TO BUYER AND IS IN LIEU OF ALL OTHER WARRANTIES, EXPRESSED, IMPLIED, OR STATUTORY, INCLUDING ANY WARRANTY OF MERCHANTABILITY OR FITNESS FOR ANY PARTICULAR PURPOSE. EXCEPT TO THE EXTENT OF THIS INDEMNITY, NEITHER PARTY SHALL BE LIABLE TO THE OTHER FOR ANY INDIRECT, SPECIAL, INCIDENTAL, OR CONSEQUENTIAL DAMAGES.**

The user assumes all responsibility and liability for proper and safe handling of the goods. Further, the user releases LTC from all claims arising from the handling or use of the goods. Due to the open construction of the product, it is the user's responsibility to take any and all appropriate precautions with regard to electrostatic discharge. Also be aware that the products herein may not be regulatory compliant or agency certified (FCC, UL, CE, etc.).

No License is granted under any patent right or other intellectual property whatsoever. **LTC assumes no liability for applications assistance, customer product design, software performance, or infringement of patents or any other intellectual property rights of any kind.**

LTC currently services a variety of customers for products around the world, and therefore this transaction **is not exclusive**.

Please read the DEMO BOARD manual prior to handling the product. Persons handling this product must have electronics training and observe good laboratory practice standards. **Common sense is encouraged.**

This notice contains important safety information about temperatures and voltages. For further safety concerns, please contact a LTC application engineer.

Mailing Address:

Linear Technology
1630 McCarthy Blvd.
Milpitas, CA 95035

Copyright © 2004, Linear Technology Corporation

Компания «Океан Электроники» предлагает заключение долгосрочных отношений при поставках импортных электронных компонентов на взаимовыгодных условиях!

Наши преимущества:

- Поставка оригинальных импортных электронных компонентов напрямую с производств Америки, Европы и Азии, а так же с крупнейших складов мира;
- Широкая линейка поставок активных и пассивных импортных электронных компонентов (более 30 млн. наименований);
- Поставка сложных, дефицитных, либо снятых с производства позиций;
- Оперативные сроки поставки под заказ (от 5 рабочих дней);
- Экспресс доставка в любую точку России;
- Помощь Конструкторского Отдела и консультации квалифицированных инженеров;
- Техническая поддержка проекта, помощь в подборе аналогов, поставка прототипов;
- Поставка электронных компонентов под контролем ВП;
- Система менеджмента качества сертифицирована по Международному стандарту ISO 9001;
- При необходимости вся продукция военного и аэрокосмического назначения проходит испытания и сертификацию в лаборатории (по согласованию с заказчиком);
- Поставка специализированных компонентов военного и аэрокосмического уровня качества (Xilinx, Altera, Analog Devices, Intersil, Interpoint, Microsemi, Actel, Aeroflex, Peregrine, VPT, Syfer, Eurofarad, Texas Instruments, MS Kennedy, Miteq, Cobham, E2V, MA-COM, Hittite, Mini-Circuits, General Dynamics и др.);

Компания «Океан Электроники» является официальным дистрибьютором и эксклюзивным представителем в России одного из крупнейших производителей разъемов военного и аэрокосмического назначения «JONHON», а так же официальным дистрибьютором и эксклюзивным представителем в России производителя высокотехнологичных и надежных решений для передачи СВЧ сигналов «FORSTAR».



JONHON

«JONHON» (основан в 1970 г.)

Разъемы специального, военного и аэрокосмического назначения:

(Применяются в военной, авиационной, аэрокосмической, морской, железнодорожной, горно- и нефтедобывающей отраслях промышленности)

«FORSTAR» (основан в 1998 г.)

ВЧ соединители, коаксиальные кабели, кабельные сборки и микроволновые компоненты:

(Применяются в телекоммуникациях гражданского и специального назначения, в средствах связи, РЛС, а так же военной, авиационной и аэрокосмической отраслях промышленности).



Телефон: 8 (812) 309-75-97 (многоканальный)

Факс: 8 (812) 320-03-32

Электронная почта: ocean@oceanchips.ru

Web: <http://oceanchips.ru/>

Адрес: 198099, г. Санкт-Петербург, ул. Калинина, д. 2, корп. 4, лит. А