



**128K x 32, 128K x 36, 256K x 18**  
**4 Mb SYNCHRONOUS FLOW-THROUGH STATIC RAM**

SEPTEMBER 2011

**FEATURES**

- Internal self-timed write cycle
- Individual Byte Write Control and Global Write
- Clock controlled, registered address, data and control
- Burst sequence control using MODE input
- Three chip enable option for simple depth expansion and address pipelining
- Common data inputs and data outputs
- Auto Power-down during deselect
- Single cycle deselect
- Snooze MODE for reduced-power standby
- Power Supply  
 LF:  $V_{DD} 3.3V \pm 5\%$ ,  $V_{DDQ} 3.3V/2.5V \pm 5\%$   
 VF:  $V_{DD} 2.5V -5\% +10\%$ ,  $V_{DDQ} 2.5V -5\% +10\%$
- JEDEC 100-Pin TQFP, 119-pin PBGA, and 165-pin PBGA packages
- Automotive temperature available
- Lead-free available

**DESCRIPTION**

The *ISSI* IS61(64)LF12832A, IS64VF12832A, IS61(64)LF/VF12836A and IS61(64)LF/VF25618A are high-speed, low-power synchronous static RAMs designed to provide burstable, high-performance memory for communication and networking applications. The IS61(64)LF12832A is organized as 131,072 words by 32 bits. The IS61(64)LF/VF12836A is organized as 131,072 words by 36 bits. The IS61(64)LF/VF25618A is organized as 262,144 words by 18 bits. Fabricated with *ISSI*'s advanced CMOS technology, the device integrates a 2-bit burst counter, high-speed SRAM core, and high-drive capability outputs into a single monolithic circuit. All synchronous inputs pass through registers controlled by a positive-edge-triggered single clock input.

Write cycles are internally self-timed and are initiated by the rising edge of the clock input. Write cycles can be one to four bytes wide as controlled by the write control inputs.

Separate byte enables allow individual bytes to be written. Byte write operation is performed by using byte write enable ( $\overline{BWE}$ ) input combined with one or more individual byte write signals ( $\overline{BWx}$ ). In addition, Global Write ( $\overline{GW}$ ) is available for writing all bytes at one time, regardless of the byte write controls.

Bursts can be initiated with either  $\overline{ADSP}$  (Address Status Processor) or  $\overline{ADSC}$  (Address Status Cache Controller) input pins. Subsequent burst addresses can be generated internally and controlled by the  $\overline{ADV}$  (burst address advance) input pin.

The mode pin is used to select the burst sequence order, Linear burst is achieved when this pin is tied LOW. Interleave burst is achieved when this pin is tied HIGH or left floating.

**FAST ACCESS TIME**

Symbol	Parameter	-6.5	-7.5	Units
tkQ	Clock Access Time	6.5	7.5	ns
tkc	Cycle Time	7.5	8.5	ns
	Frequency	133	117	MHz

Copyright © 2011 Integrated Silicon Solution, Inc. All rights reserved. ISSI reserves the right to make changes to this specification and its products at any time without notice. ISSI assumes no liability arising out of the application or use of any information, products or services described herein. Customers are advised to obtain the latest version of this device specification before relying on any published information and before placing orders for products.

Integrated Silicon Solution, Inc. does not recommend the use of any of its products in life support applications where the failure or malfunction of the product can reasonably be expected to cause failure of the life support system or to significantly affect its safety or effectiveness. Products are not authorized for use in such applications unless Integrated Silicon Solution, Inc. receives written assurance to its satisfaction, that:

- a.) the risk of injury or damage has been minimized;
- b.) the user assume all such risks; and
- c.) potential liability of Integrated Silicon Solution, Inc is adequately protected under the circumstances

**BLOCK DIAGRAM**



**165-PIN BGA**

165-Ball, 13x15 mm BGA

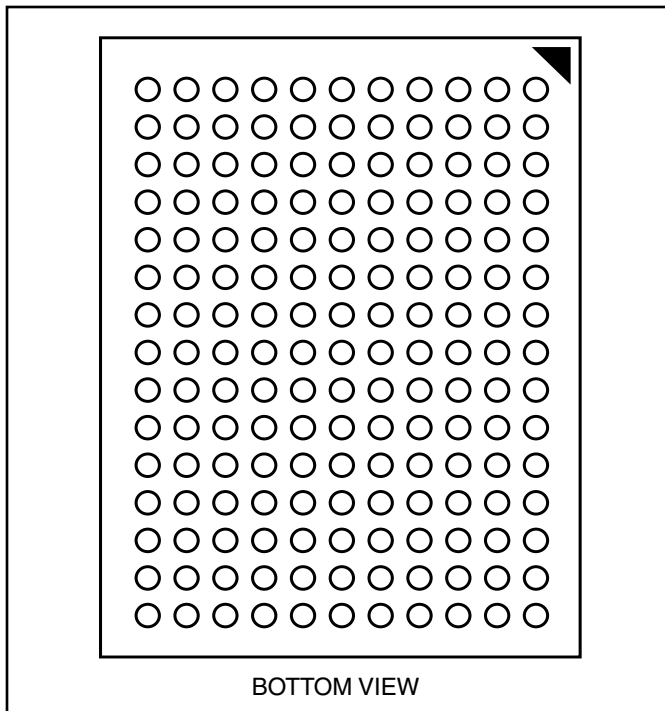

**119-PIN BGA**

119-Ball, 14x22 mm BGA

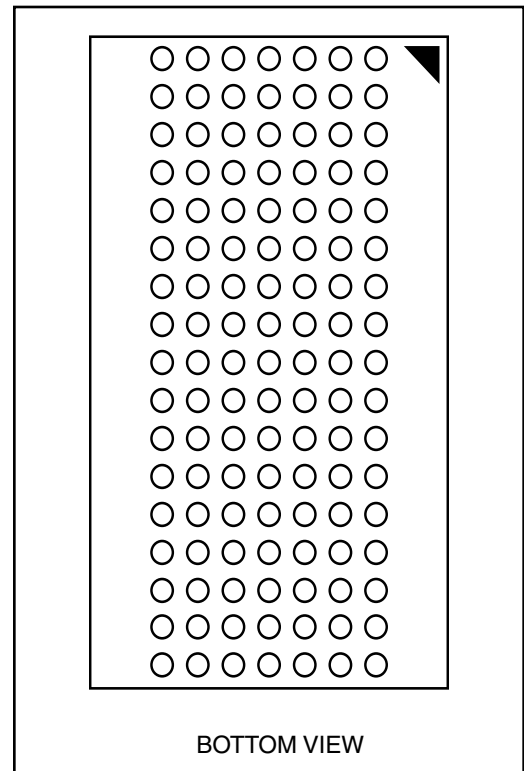

## 119 BGA PACKAGE PIN CONFIGURATION

128K x 36 (TOP VIEW)

	1	2	3	4	5	6	7
<b>A</b>	V <sub>DDQ</sub>	A	A	$\overline{\text{ADSP}}$	A	A	V <sub>DDQ</sub>
<b>B</b>	NC	CE2	A	$\overline{\text{ADSC}}$	A	$\overline{\text{CE2}}$	NC
<b>C</b>	NC	A	A	V <sub>DD</sub>	A	A	NC
<b>D</b>	DQc	DQPc	V <sub>SS</sub>	NC	V <sub>SS</sub>	DQPb	DQb
<b>E</b>	DQc	DQc	V <sub>SS</sub>	$\overline{\text{CE}}$	V <sub>SS</sub>	DQb	DQb
<b>F</b>	V <sub>DDQ</sub>	DQc	V <sub>SS</sub>	$\overline{\text{OE}}$	V <sub>SS</sub>	DQb	V <sub>DDQ</sub>
<b>G</b>	DQc	DQc	$\overline{\text{BWc}}$	$\overline{\text{ADV}}$	$\overline{\text{BWb}}$	DQb	DQb
<b>H</b>	DQc	DQc	V <sub>SS</sub>	$\overline{\text{GW}}$	V <sub>SS</sub>	DQb	DQb
<b>J</b>	V <sub>DDQ</sub>	V <sub>DD</sub>	NC	V <sub>DD</sub>	NC	V <sub>DD</sub>	V <sub>DDQ</sub>
<b>K</b>	DQd	DQd	V <sub>SS</sub>	CLK	V <sub>SS</sub>	DQa	DQa
<b>L</b>	DQd	DQd	$\overline{\text{BWd}}$	NC	$\overline{\text{BWA}}$	DQa	DQa
<b>M</b>	V <sub>DDQ</sub>	DQd	V <sub>SS</sub>	$\overline{\text{BWE}}$	V <sub>SS</sub>	DQa	V <sub>DDQ</sub>
<b>N</b>	DQd	DQd	V <sub>SS</sub>	A <sub>1</sub> *	V <sub>SS</sub>	DQa	DQa
<b>P</b>	DQd	DQPd	V <sub>SS</sub>	A <sub>0</sub> *	V <sub>SS</sub>	DQPa	DQa
<b>R</b>	NC	A	MODE	V <sub>DD</sub>	NC	A	NC
<b>T</b>	NC	NC	A	A	A	NC	ZZ
<b>U</b>	V <sub>DDQ</sub>	NC	NC	NC	NC	NC	V <sub>DDQ</sub>

**Note:** \* A<sub>0</sub> and A<sub>1</sub> are the two least significant bits (LSB) of the address field and set the internal burst counter if burst is desired.

## PIN DESCRIPTIONS

Symbol	Pin Name
A	Address Inputs
A <sub>0</sub> , A <sub>1</sub>	Synchronous Burst Address Inputs
$\overline{\text{ADV}}$	Synchronous Burst Address Advance
$\overline{\text{ADSP}}$	Address Status Processor
$\overline{\text{ADSC}}$	Address Status Controller
$\overline{\text{GW}}$	Global Write Enable
CLK	Synchronous Clock
$\overline{\text{CE}}$ , CE2, $\overline{\text{CE2}}$	Synchronous Chip Select
$\overline{\text{BWx}}$ (x=a-d)	Synchronous Byte Write Controls
$\overline{\text{BWE}}$	Byte Write Enable

Symbol	Pin Name
$\overline{\text{OE}}$	Output Enable
ZZ	Power Sleep Mode
MODE	Burst Sequence Selection
NC	No Connect
DQa-DQd	Data Inputs/Outputs
DQPa-Pd	Output Power Supply
V <sub>DD</sub>	Power Supply
V <sub>DDQ</sub>	Output Power Supply
V <sub>SS</sub>	Ground

## 119 BGA PACKAGE PIN CONFIGURATION

256Kx18 (TOP VIEW)

	1	2	3	4	5	6	7
<b>A</b>	V <sub>DDQ</sub>	A	A	$\overline{\text{ADSP}}$	A	A	V <sub>DDQ</sub>
<b>B</b>	NC	CE2	A	$\overline{\text{ADSC}}$	A	$\overline{\text{CE2}}$	NC
<b>C</b>	NC	A	A	V <sub>DD</sub>	A	A	NC
<b>D</b>	DQb	NC	V <sub>SS</sub>	NC	V <sub>SS</sub>	DQP <sub>a</sub>	NC
<b>E</b>	NC	DQb	V <sub>SS</sub>	$\overline{\text{CE}}$	V <sub>SS</sub>	NC	DQ <sub>a</sub>
<b>F</b>	V <sub>DDQ</sub>	NC	V <sub>SS</sub>	$\overline{\text{OE}}$	V <sub>SS</sub>	DQ <sub>a</sub>	V <sub>DDQ</sub>
<b>G</b>	NC	DQb	$\overline{\text{BWb}}$	$\overline{\text{ADV}}$	V <sub>SS</sub>	NC	DQ <sub>a</sub>
<b>H</b>	DQb	NC	V <sub>SS</sub>	$\overline{\text{GW}}$	V <sub>SS</sub>	DQ <sub>a</sub>	NC
<b>J</b>	V <sub>DDQ</sub>	V <sub>DD</sub>	NC	V <sub>DD</sub>	NC	V <sub>DD</sub>	V <sub>DDQ</sub>
<b>K</b>	NC	DQb	V <sub>SS</sub>	CLK	V <sub>SS</sub>	NC	DQ <sub>a</sub>
<b>L</b>	DQb	NC	V <sub>SS</sub>	NC	$\overline{\text{BWa}}$	DQ <sub>a</sub>	NC
<b>M</b>	V <sub>DDQ</sub>	DQb	V <sub>SS</sub>	$\overline{\text{BWE}}$	V <sub>SS</sub>	NC	V <sub>DDQ</sub>
<b>N</b>	DQb	NC	V <sub>SS</sub>	A <sub>1</sub> *	V <sub>SS</sub>	DQ <sub>a</sub>	NC
<b>P</b>	NC	DQP <sub>b</sub>	V <sub>SS</sub>	A <sub>0</sub> *	V <sub>SS</sub>	NC	DQ <sub>a</sub>
<b>R</b>	NC	A	MODE	V <sub>DD</sub>	NC	A	NC
<b>T</b>	NC	A	A	NC	A	A	ZZ
<b>U</b>	V <sub>DDQ</sub>	NC	NC	NC	NC	NC	V <sub>DDQ</sub>

**Note:** \* A<sub>0</sub> and A<sub>1</sub> are the two least significant bits (LSB) of the address field and set the internal burst counter if burst is desired.

## PIN DESCRIPTIONS

Symbol	Pin Name
A	Address Inputs
A <sub>0</sub> , A <sub>1</sub>	Synchronous Burst Address Inputs
$\overline{\text{ADV}}$	Synchronous Burst Address Advance
$\overline{\text{ADSP}}$	Address Status Processor
$\overline{\text{ADSC}}$	Address Status Controller
$\overline{\text{GW}}$	Global Write Enable
CLK	Synchronous Clock
$\overline{\text{CE}}$ , CE2, $\overline{\text{CE2}}$	Synchronous Chip Select
$\overline{\text{BWx}}$ (x=a,b)	Synchronous Byte Write Controls
$\overline{\text{BWE}}$	Byte Write Enable

Symbol	Pin Name
$\overline{\text{OE}}$	Output Enable
ZZ	Power Sleep Mode
MODE	Burst Sequence Selection
NC	No Connect
DQ <sub>a</sub> -DQ <sub>b</sub>	Data Inputs/Outputs
DQP <sub>a</sub> -P <sub>b</sub>	Output Power Supply
V <sub>DD</sub>	Power Supply
V <sub>DDQ</sub>	Output Power Supply
V <sub>SS</sub>	Ground



## 165 PBGA PACKAGE PIN CONFIGURATION

128K x 36 (TOP VIEW)

	1	2	3	4	5	6	7	8	9	10	11
<b>A</b>	NC	A	$\overline{CE}$	BWc	BWb	CE2	$\overline{BWE}$	ADSC	$\overline{ADV}$	A	NC
<b>B</b>	NC	A	CE2	$\overline{BWd}$	$\overline{BWa}$	CLK	$\overline{GW}$	$\overline{OE}$	$\overline{ADSP}$	A	NC
<b>C</b>	DQPc	NC	VDDQ	VSS	VSS	VSS	VSS	VSS	VDDQ	NC	DQPb
<b>D</b>	DQc	DQc	VDDQ	VDD	VSS	VSS	VSS	VDD	VDDQ	DQb	DQb
<b>E</b>	DQc	DQc	VDDQ	VDD	VSS	VSS	VSS	VDD	VDDQ	DQb	DQb
<b>F</b>	DQc	DQc	VDDQ	VDD	VSS	VSS	VSS	VDD	VDDQ	DQb	DQb
<b>G</b>	DQc	DQc	VDDQ	VDD	VSS	VSS	VSS	VDD	VDDQ	DQb	DQb
<b>H</b>	NC	NC	NC	VDD	VSS	VSS	VSS	VDD	NC	NC	ZZ
<b>J</b>	DQd	DQd	VDDQ	VDD	VSS	VSS	VSS	VDD	VDDQ	DQa	DQa
<b>K</b>	DQd	DQd	VDDQ	VDD	VSS	VSS	VSS	VDD	VDDQ	DQa	DQa
<b>L</b>	DQd	DQd	VDDQ	VDD	VSS	VSS	VSS	VDD	VDDQ	DQa	DQa
<b>M</b>	DQd	DQd	VDDQ	VDD	VSS	VSS	VSS	VDD	VDDQ	DQa	DQa
<b>N</b>	DQPd	NC	VDDQ	VSS	NC	NC	NC	VSS	VDDQ	NC	DQPa
<b>P</b>	NC	NC	A	A	NC	A1*	NC	A	A	A	NC
<b>R</b>	MODE	NC	A	A	NC	A0*	NC	A	A	A	A

**Note:** \* A0 and A1 are the two least significant bits (LSB) of the address field and set the internal burst counter if burst is desired.

## PIN DESCRIPTIONS

Symbol	Pin Name
A	Address Inputs
A0, A1	Synchronous Burst Address Inputs
$\overline{ADV}$	Synchronous Burst Address Advance
$\overline{ADSP}$	Address Status Processor
$\overline{ADSC}$	Address Status Controller
$\overline{GW}$	Global Write Enable
CLK	Synchronous Clock
$\overline{CE}$ , CE2, CE2	Synchronous Chip Select
$\overline{BWx}$ (x=a,b,c,d)	Synchronous Byte Write Controls

Symbol	Pin Name
$\overline{BWE}$	Byte Write Enable
$\overline{OE}$	Output Enable
ZZ	Power Sleep Mode
MODE	Burst Sequence Selection
NC	No Connect
DQx	Data Inputs/Outputs
DQPx	Data Inputs/Outputs
VDD	3.3V/2.5V Power Supply
VDDQ	Isolated Output Power Supply 3.3V/2.5V
VSS	Ground



## 165 PBGA PACKAGE PIN CONFIGURATION

256K x 18 (TOP VIEW)

	1	2	3	4	5	6	7	8	9	10	11
<b>A</b>	NC	A	$\overline{CE}$	$\overline{BWb}$	NC	$\overline{CE2}$	$\overline{BWE}$	$\overline{ADSC}$	ADV	A	A
<b>B</b>	NC	A	CE2	NC	$\overline{BWa}$	CLK	$\overline{GW}$	$\overline{OE}$	$\overline{ADSP}$	A	NC
<b>C</b>	NC	NC	V <sub>DDQ</sub>	V <sub>SS</sub>	V <sub>SS</sub>	V <sub>SS</sub>	V <sub>SS</sub>	V <sub>SS</sub>	V <sub>DDQ</sub>	NC	DQP <sub>a</sub>
<b>D</b>	NC	DQ <sub>b</sub>	V <sub>DDQ</sub>	V <sub>DD</sub>	V <sub>SS</sub>	V <sub>SS</sub>	V <sub>SS</sub>	V <sub>DD</sub>	V <sub>DDQ</sub>	NC	DQ <sub>a</sub>
<b>E</b>	NC	DQ <sub>b</sub>	V <sub>DDQ</sub>	V <sub>DD</sub>	V <sub>SS</sub>	V <sub>SS</sub>	V <sub>SS</sub>	V <sub>DD</sub>	V <sub>DDQ</sub>	NC	DQ <sub>a</sub>
<b>F</b>	NC	DQ <sub>b</sub>	V <sub>DDQ</sub>	V <sub>DD</sub>	V <sub>SS</sub>	V <sub>SS</sub>	V <sub>SS</sub>	V <sub>DD</sub>	V <sub>DDQ</sub>	NC	DQ <sub>a</sub>
<b>G</b>	NC	DQ <sub>b</sub>	V <sub>DDQ</sub>	V <sub>DD</sub>	V <sub>SS</sub>	V <sub>SS</sub>	V <sub>SS</sub>	V <sub>DD</sub>	V <sub>DDQ</sub>	NC	DQ <sub>a</sub>
<b>H</b>	NC	NC	NC	V <sub>DD</sub>	V <sub>SS</sub>	V <sub>SS</sub>	V <sub>SS</sub>	V <sub>DD</sub>	NC	NC	ZZ
<b>J</b>	DQ <sub>b</sub>	NC	V <sub>DDQ</sub>	V <sub>DD</sub>	V <sub>SS</sub>	V <sub>SS</sub>	V <sub>SS</sub>	V <sub>DD</sub>	V <sub>DDQ</sub>	DQ <sub>a</sub>	NC
<b>K</b>	DQ <sub>b</sub>	NC	V <sub>DDQ</sub>	V <sub>DD</sub>	V <sub>SS</sub>	V <sub>SS</sub>	V <sub>SS</sub>	V <sub>DD</sub>	V <sub>DDQ</sub>	DQ <sub>a</sub>	NC
<b>L</b>	DQ <sub>b</sub>	NC	V <sub>DDQ</sub>	V <sub>DD</sub>	V <sub>SS</sub>	V <sub>SS</sub>	V <sub>SS</sub>	V <sub>DD</sub>	V <sub>DDQ</sub>	DQ <sub>a</sub>	NC
<b>M</b>	DQ <sub>b</sub>	NC	V <sub>DDQ</sub>	V <sub>DD</sub>	V <sub>SS</sub>	V <sub>SS</sub>	V <sub>SS</sub>	V <sub>DD</sub>	V <sub>DDQ</sub>	DQ <sub>a</sub>	NC
<b>N</b>	DQP <sub>b</sub>	NC	V <sub>DDQ</sub>	V <sub>SS</sub>	NC	NC	NC	V <sub>SS</sub>	V <sub>DDQ</sub>	NC	NC
<b>P</b>	NC	NC	A	A	NC	A <sub>1</sub> *	NC	A	A	A	NC
<b>R</b>	MODE	NC	A	A	NC	A <sub>0</sub> *	NC	A	A	A	A

Note: \* A<sub>0</sub> and A<sub>1</sub> are the two least significant bits (LSB) of the address field and set the internal burst counter if burst is desired.

## PIN DESCRIPTIONS

Symbol	Pin Name
A	Address Inputs
A <sub>0</sub> , A <sub>1</sub>	Synchronous Burst Address Inputs
ADV	Synchronous Burst Address Advance
$\overline{ADSP}$	Address Status Processor
$\overline{ADSC}$	Address Status Controller
$\overline{GW}$	Global Write Enable
CLK	Synchronous Clock
$\overline{CE}$ , $\overline{CE2}$ , CE2	Synchronous Chip Select
$\overline{BWx}$ (x=a,b)	Synchronous Byte Write Controls

Symbol	Pin Name
$\overline{BWE}$	Byte Write Enable
$\overline{OE}$	Output Enable
ZZ	Power Sleep Mode
MODE	Burst Sequence Selection
NC	No Connect
DQ <sub>x</sub>	Data Inputs/Outputs
DQP <sub>x</sub>	Data Inputs/Outputs
V <sub>DD</sub>	3.3V/2.5V Power Supply
V <sub>DDQ</sub>	Isolated Output Power Supply 3.3V/2.5V
V <sub>SS</sub>	Ground

## PIN CONFIGURATION

100-PIN TQFP (128K x 36)

100-PIN TQFP (128K x 32)

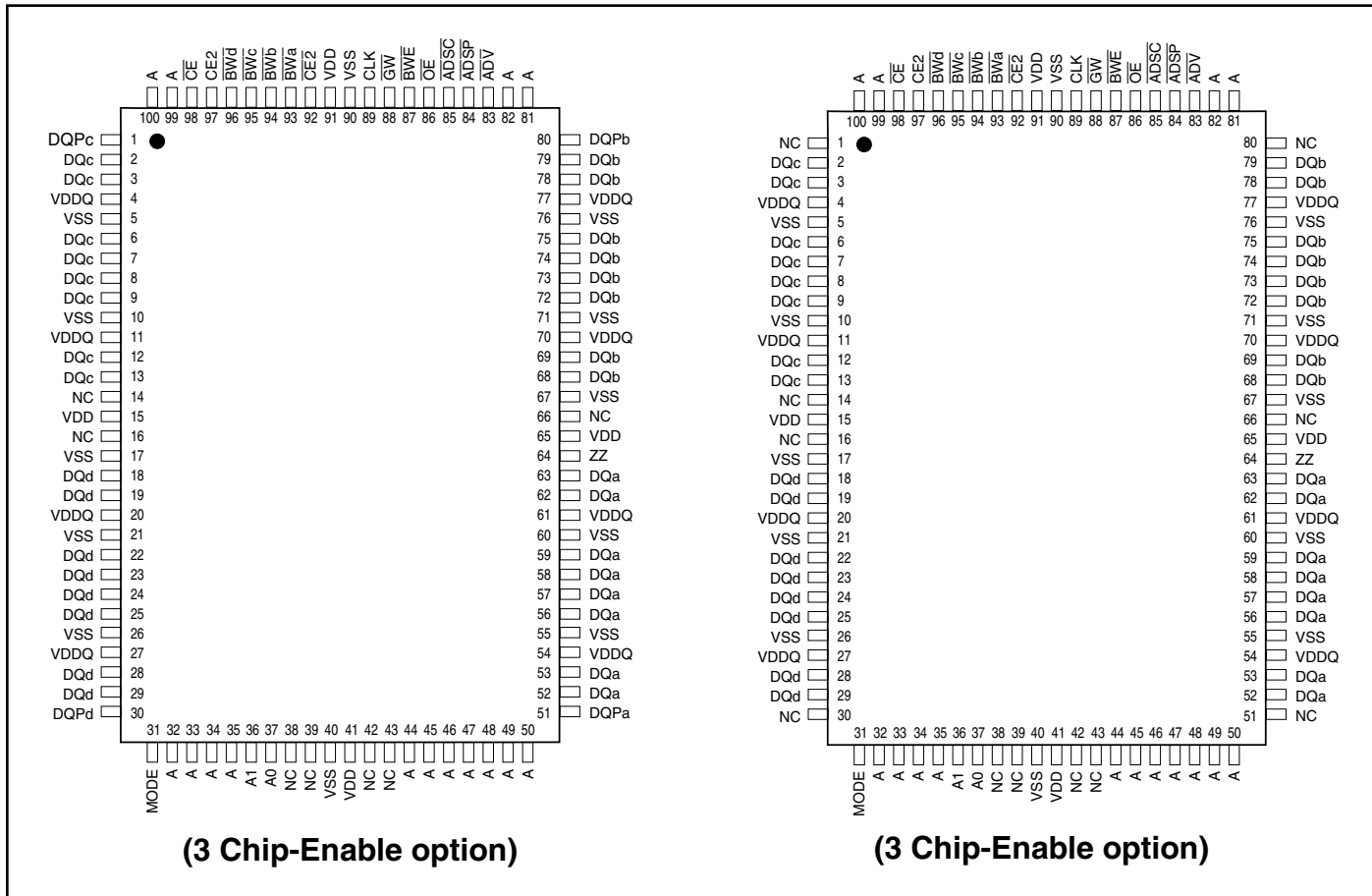

## PIN DESCRIPTIONS

A0, A1	Synchronous Address Inputs. These pins must tied to the two LSBs of the address bus.	DQa-DQd	Synchronous Data Input/Output
A	Synchronous Address Inputs	DQPa-DQPd	Parity Data Input/Output
$\overline{\text{ADSC}}$	Synchronous Controller Address Status	$\overline{\text{GW}}$	Synchronous Global Write Enable
$\overline{\text{ADSP}}$	Synchronous Processor Address Status	MODE	Burst Sequence Mode Selection
$\overline{\text{ADV}}$	Synchronous Burst Address Advance	$\overline{\text{OE}}$	Output Enable
$\overline{\text{BWA-BWd}}$	Synchronous Byte Write Enable	VDD	3.3V/2.5V Power Supply
$\overline{\text{BWE}}$	Synchronous Byte Write Enable	VDDQ	Isolated Output Buffer Supply: 3.3V/2.5V
$\overline{\text{CE}}, \overline{\text{CE2}}, \overline{\text{CE2}}$	Synchronous Chip Enable	VSS	Ground
CLK	Synchronous Clock	ZZ	Snooze Enable



## PIN CONFIGURATION

### 100-PIN TQFP (256K x 18)



## PIN DESCRIPTIONS

A0, A1	Synchronous Address Inputs. These pins must tied to the two LSBs of the address bus.
A	Synchronous Address Inputs
$\overline{\text{ADSC}}$	Synchronous Controller Address Status
$\overline{\text{ADSP}}$	Synchronous Processor Address Status
$\overline{\text{ADV}}$	Synchronous Burst Address Advance
$\overline{\text{BWA}}\text{-}\overline{\text{BWB}}$	Synchronous Byte Write Enable
$\overline{\text{BWE}}$	Synchronous Byte Write Enable
$\overline{\text{CE}}$ , $\overline{\text{CE2}}$ , $\overline{\text{CE2}}$	Synchronous Chip Enable
CLK	Synchronous Clock
DQa-DQb	Synchronous Data Input/Output

DQPa-DQPb	Parity Data I/O; DQPa is parity for DQa1-8; DQPb is parity for DQb1-8
$\overline{\text{GW}}$	Synchronous Global Write Enable
MODE	Burst Sequence Mode Selection
$\overline{\text{OE}}$	Output Enable
VDD	3.3V/2.5V Power Supply
VDDQ	Isolated Output Buffer Supply: 3.3V/2.5V
Vss	Ground
ZZ	Snooze Enable



**TRUTH TABLE<sup>(1-8)</sup>**

OPERATION	ADDRESS	$\overline{CE}$	$\overline{CE2}$	CE2	ZZ	$\overline{ADSP}$	$\overline{ADSC}$	$\overline{ADV}$	$\overline{WRITE}$	$\overline{OE}$	CLK	DQ
Deselect Cycle, Power-Down	None	H	X	X	L	X	L	X	X	X	L-H	High-Z
Deselect Cycle, Power-Down	None	L	X	L	L	L	X	X	X	X	L-H	High-Z
Deselect Cycle, Power-Down	None	L	H	X	L	L	X	X	X	X	L-H	High-Z
Deselect Cycle, Power-Down	None	L	X	L	L	H	L	X	X	X	L-H	High-Z
Deselect Cycle, Power-Down	None	L	H	X	L	H	L	X	X	X	L-H	High-Z
Snooze Mode, Power-Down	None	X	X	X	H	X	X	X	X	X	X	High-Z
Read Cycle, Begin Burst	External	L	L	H	L	L	X	X	X	L	L-H	Q
Read Cycle, Begin Burst	External	L	L	H	L	L	X	X	X	H	L-H	High-Z
Write Cycle, Begin Burst	External	L	L	H	L	H	L	X	L	X	L-H	D
Read Cycle, Begin Burst	External	L	L	H	L	H	L	X	H	L	L-H	Q
Read Cycle, Begin Burst	External	L	L	H	L	H	L	X	H	H	L-H	High-Z
Read Cycle, Continue Burst	Next	X	X	X	L	H	H	L	H	L	L-H	Q
Read Cycle, Continue Burst	Next	X	X	X	L	H	H	L	H	H	L-H	High-Z
Read Cycle, Continue Burst	Next	H	X	X	L	X	H	L	H	L	L-H	Q
Read Cycle, Continue Burst	Next	H	X	X	L	X	H	L	H	H	L-H	High-Z
Write Cycle, Continue Burst	Next	X	X	X	L	H	H	L	L	X	L-H	D
Write Cycle, Continue Burst	Next	H	X	X	L	X	H	L	L	X	L-H	D
Read Cycle, Suspend Burst	Current	X	X	X	L	H	H	H	H	L	L-H	Q
Read Cycle, Suspend Burst	Current	X	X	X	L	H	H	H	H	H	L-H	High-Z
Read Cycle, Suspend Burst	Current	H	X	X	L	X	H	H	H	L	L-H	Q
Read Cycle, Suspend Burst	Current	H	X	X	L	X	H	H	H	H	L-H	High-Z
Write Cycle, Suspend Burst	Current	X	X	X	L	H	H	H	L	X	L-H	D
Write Cycle, Suspend Burst	Current	H	X	X	L	X	H	H	L	X	L-H	D

**NOTE:**

1. X means "Don't Care." H means logic HIGH. L means logic LOW.
2. For  $\overline{WRITE}$ , L means one or more byte write enable signals ( $\overline{BWA-d}$ ) and  $\overline{BWE}$  are LOW or  $\overline{GW}$  is LOW.  $\overline{WRITE} = H$  for all  $\overline{BWx}$ ,  $\overline{BWE}$ ,  $\overline{GW}$  HIGH.
3.  $\overline{BWA}$  enables WRITES to DQa's and DQP<sub>a</sub>.  $\overline{BWb}$  enables WRITES to DQb's and DQP<sub>b</sub>.  $\overline{BWc}$  enables WRITES to DQc's and DQP<sub>c</sub>.  $\overline{BWD}$  enables WRITES to DQd's and DQP<sub>d</sub>. DQP<sub>a</sub> and DQP<sub>b</sub> are available on the x18 version. DQP<sub>a</sub>-DQP<sub>d</sub> are available on the x36 version.
4. All inputs except  $\overline{OE}$  and ZZ must meet setup and hold times around the rising edge (LOW to HIGH) of CLK.
5. Wait states are inserted by suspending burst.
6. For a WRITE operation following a READ operation,  $\overline{OE}$  must be HIGH before the input data setup time and held HIGH during the input data hold time.
7. This device contains circuitry that will ensure the outputs will be in High-Z during power-up.
8.  $\overline{ADSP}$  LOW always initiates an internal READ at the L-H edge of CLK. A WRITE is performed by setting one or more byte write enable signals and  $\overline{BWE}$  LOW or  $\overline{GW}$  LOW for the subsequent L-H edge of CLK. See WRITE timing diagram for clarification.

**PARTIAL TRUTH TABLE**

Function	$\overline{GW}$	$\overline{BWE}$	$\overline{BWA}$	$\overline{BWb}$	$\overline{BWc}$	$\overline{BWD}$
Read	H	H	X	X	X	X
Read	H	L	H	H	H	H
Write Byte 1	H	L	L	H	H	H
Write All Bytes	H	L	L	L	L	L
Write All Bytes	L	X	X	X	X	X

**INTERLEAVED BURST ADDRESS TABLE (MODE = V<sub>DD</sub> or No Connect)**

External Address A1 A0	1st Burst Address A1 A0	2nd Burst Address A1 A0	3rd Burst Address A1 A0
00	01	10	11
01	00	11	10
10	11	00	01
11	10	01	00

**LINEAR BURST ADDRESS TABLE (MODE = V<sub>SS</sub>)**



**ABSOLUTE MAXIMUM RATINGS<sup>(1)</sup>**

Symbol	Parameter	Value	Unit
T <sub>STG</sub>	Storage Temperature	-55 to +150	°C
P <sub>D</sub>	Power Dissipation	1.6	W
I <sub>OUT</sub>	Output Current (per I/O)	100	mA
V <sub>IN</sub> , V <sub>OUT</sub>	Voltage Relative to V <sub>SS</sub> for I/O Pins	-0.5 to V <sub>DDQ</sub> + 0.5	V
V <sub>IN</sub>	Voltage Relative to V <sub>SS</sub> for for Address and Control Inputs	-0.5 to V <sub>DD</sub> + 0.5	V
V <sub>DD</sub>	Voltage on V <sub>DD</sub> Supply Relative to V <sub>SS</sub>	-0.5 to 4.6	V

**Notes:**

1. Stress greater than those listed under ABSOLUTE MAXIMUM RATINGS may cause permanent damage to the device. This is a stress rating only and functional operation of the device at these or any other conditions above those indicated in the operational sections of this specification is not implied. Exposure to absolute maximum rating conditions for extended periods may affect reliability.
2. This device contains circuitry to protect the inputs against damage due to high static voltages or electric fields; however, precautions may be taken to avoid application of any voltage higher than maximum rated voltages to this high-impedance circuit.
3. This device contains circuitry that will ensure the output devices are in High-Z at power up.

### OPERATING RANGE (IS61/64LFxxxxx)

Range	Ambient Temperature	V <sub>DD</sub>	V <sub>DDQ</sub>
Commercial	0°C to +70°C	3.3V ± 5%	3.3V/2.5V ± 5%
Industrial	-40°C to +85°C	3.3V ± 5%	3.3V/2.5V ± 5%
Automotive	-40°C to +125°C	3.3V ± 5%	3.3V/2.5V ± 5%

### OPERATING RANGE (IS61/64VFxxxxx)

Range	Ambient Temperature	V <sub>DD</sub>	V <sub>DDQ</sub>
Commercial	0°C to +70°C	2.5V -5% +10%	2.5V -5% +10%
Industrial	-40°C to +85°C	2.5V -5% +10%	2.5V -5% +10%
Automotive	-40°C to +125°C	2.5V -5% +10%	2.5V -5% +10%

### DC ELECTRICAL CHARACTERISTICS (Over Operating Range)

Symbol	Parameter	Test Conditions	3.3V		2.5V		Unit
			Min.	Max.	Min.	Max.	
V <sub>OH</sub>	Output HIGH Voltage	I <sub>OH</sub> = -4.0 mA (3.3V) I <sub>OH</sub> = -1.0 mA (2.5V)	2.4	—	2.0	—	V
V <sub>OL</sub>	Output LOW Voltage	I <sub>OL</sub> = 8.0 mA (3.3V) I <sub>OL</sub> = 1.0 mA (2.5V)	—	0.4	—	0.4	V
V <sub>IH</sub>	Input HIGH Voltage <sup>(1)</sup>		2.0	V <sub>DD</sub> + 0.3	1.7	V <sub>DD</sub> + 0.3	V
V <sub>IL</sub>	Input LOW Voltage <sup>(1)</sup>		-0.3	0.8	-0.3	0.7	V
I <sub>LI</sub>	Input Leakage Current	V <sub>SS</sub> ≤ V <sub>IN</sub> ≤ V <sub>DD</sub> <sup>(1)</sup>	-5	5	-5	5	μA
I <sub>LO</sub>	Output Leakage Current	V <sub>SS</sub> ≤ V <sub>OUT</sub> ≤ V <sub>DDQ</sub> , $\overline{OE} = V_{IH}$	-5	5	-5	5	μA

**Note:**

- V<sub>ILL</sub>(min) = -2.0V AC (pulse width < t<sub>KC</sub>/ 2). Guaranteed by design.  
 V<sub>IHH</sub>(max) = V<sub>DD</sub> + 1.5V AC (pulse width < t<sub>KC</sub>/ 2). Guaranteed by design.



**POWER SUPPLY CHARACTERISTICS<sup>(1)</sup>** (Over Operating Range)

Symbol	Parameter	Test Conditions	Temp. range	6.5 MAX		7.5 MAX		Unit
				x18	x32/x36	x18	x32/x36	
I <sub>CC</sub>	AC Operating Supply Current	Device Selected,	Com.	175	175	155	155	mA
		$\overline{OE} = V_{IH}$ , $ZZ \leq V_{IL}$ ,	Ind.	180	180	160	160	
		All Inputs $\leq 0.2V$ or $\geq V_{DD} - 0.2V$ ,	Auto.	190	190	175	175	
		Cycle Time $\geq t_{kc}$ min.	typ. <sup>(2)</sup>	120		110		
I <sub>SB</sub>	Standby Current TTL Input	Device Deselected,	Com.	90	90	90	90	mA
		$V_{DD} = \text{Max.}$ ,	Ind.	100	100	100	100	
		All Inputs $\leq V_{IL}$ or $\geq V_{IH}$ ,	Auto.	120	120	120	120	
I <sub>SBI</sub>	Standby Current CMOS Input	Device Deselected,	Com.	70	70	70	70	mA
		$V_{DD} = \text{Max.}$ ,	Ind.	75	75	75	75	
		$V_{IN} \leq V_{SS} + 0.2V$ or $\geq V_{DD} - 0.2V$	Auto.	90	90	90	90	
		$f = 0$	typ.	40		40		
I <sub>SB2</sub>	Sleep Mode	$ZZ > V_{IH}$	Com.	30	30	30	30	mA
			Ind.	35	35	35	35	
			Auto.	45	45	45	45	
			typ.	25		25		

**Note:**

- MODE pin has an internal pullup and should be tied to  $V_{DD}$  or  $V_{SS}$ . It exhibits  $\pm 100 \mu A$  maximum leakage current when tied to  $\leq V_{SS} + 0.2V$  or  $\geq V_{DD} - 0.2V$ .
- Typical values are measured at  $V_{DD} = 3.3V$ ,  $T_A = 25^\circ C$  and not 100% tested.

**CAPACITANCE<sup>(1,2)</sup>**

Symbol	Parameter	Conditions	Max.	Unit
C <sub>IN</sub>	Input Capacitance	$V_{IN} = 0V$	6	pF
C <sub>OUT</sub>	Input/Output Capacitance	$V_{OUT} = 0V$	8	pF

**Notes:**

- Tested initially and after any design or process changes that may affect these parameters.
- Test conditions:  $T_A = 25^\circ C$ ,  $f = 1 \text{ MHz}$ ,  $V_{DD} = 3.3V$ .

### 3.3V I/O AC TEST CONDITIONS

Parameter	Unit
Input Pulse Level	0V to 3.0V
Input Rise and Fall Times	1.5 ns
Input and Output Timing and Reference Level	1.5V
Output Load	See Figures 1 and 2

### AC TEST LOADS



Figure 1

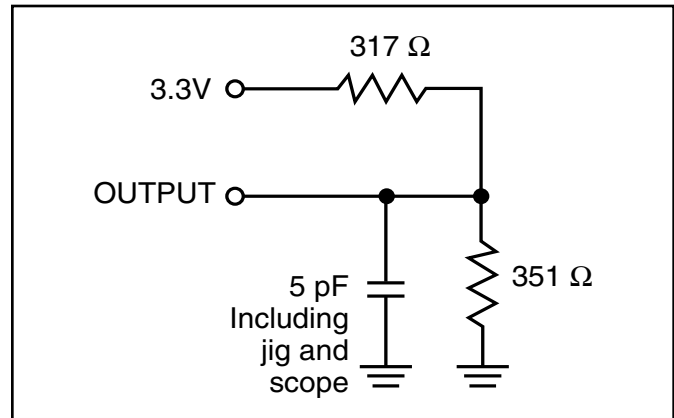

Figure 2

## 2.5V I/O AC TEST CONDITIONS

Parameter	Unit
Input Pulse Level	0V to 2.5V
Input Rise and Fall Times	1.5 ns
Input and Output Timing and Reference Level	1.25V
Output Load	See Figures 3 and 4

## 2.5V I/O OUTPUT LOAD EQUIVALENT



Figure 3



Figure 4



**READ/WRITE CYCLE SWITCHING CHARACTERISTICS<sup>(1)</sup>** (Over Operating Range)

Symbol	Parameter	6.5		7.5		Unit
		Min.	Max.	Min.	Max.	
fmax	Clock Frequency	—	133	—	117	MHz
t <sub>KC</sub>	Cycle Time	7.5	—	8.5	—	ns
t <sub>KH</sub>	Clock High Time	2.2	—	2.5	—	ns
t <sub>KL</sub>	Clock Low Time	2.2	—	2.5	—	ns
t <sub>KQ</sub>	Clock Access Time	—	6.5	—	7.5	ns
t <sub>KQX</sub> <sup>(2)</sup>	Clock High to Output Invalid	2.5	—	2.5	—	ns
t <sub>KQLZ</sub> <sup>(2,3)</sup>	Clock High to Output Low-Z	2.5	—	2.5	—	ns
t <sub>KQHZ</sub> <sup>(2,3)</sup>	Clock High to Output High-Z	—	3.8	—	4.0	ns
t <sub>OEQ</sub>	Output Enable to Output Valid	—	3.2	—	3.4	ns
t <sub>OEQX</sub> <sup>(2)</sup>	Output Enable to Output Invalid	2.5	—	2.5	—	ns
t <sub>OELZ</sub> <sup>(2,3)</sup>	Output Enable to Output Low-Z	0	—	0	—	ns
t <sub>OEHZ</sub> <sup>(2,3)</sup>	Output Disable to Output High-Z	—	3.5	—	3.5	ns
t <sub>AS</sub>	Address Setup Time	1.5	—	1.5	—	ns
t <sub>SS</sub>	Address Status Setup Time	1.5	—	1.5	—	ns
t <sub>WS</sub>	Read/Write Setup Time	1.5	—	1.5	—	ns
t <sub>CES</sub>	Chip Enable Setup Time	1.5	—	1.5	—	ns
t <sub>AVS</sub>	Address Advance Setup Time	1.5	—	1.5	—	ns
t <sub>DS</sub>	Data Setup Time	1.5	—	1.5	—	ns
t <sub>AH</sub>	Address Hold Time	0.5	—	0.5	—	ns
t <sub>WH</sub>	Write Hold Time	0.5	—	0.5	—	ns
t <sub>SH</sub>	Address Status Hold Time	0.5	—	0.5	—	ns
t <sub>CEH</sub>	Chip Enable Hold Time	0.5	—	0.5	—	ns
t <sub>AVH</sub>	Address Advance Hold Time	0.5	—	0.5	—	ns
t <sub>DH</sub>	Data Hold Time	0.5	—	0.5	—	ns
t <sub>PDS</sub>	ZZ High to Power Down	—	2	—	2	cyc
t <sub>PUS</sub>	ZZ Low to Power Down	—	2	—	2	cyc

**Notes:**

1. Configuration signal MODE is static and must not change during normal operation.
2. Guaranteed but not 100% tested. This parameter is periodically sampled.
3. Tested with load in Figure 2.



### READ/WRITE CYCLE TIMING

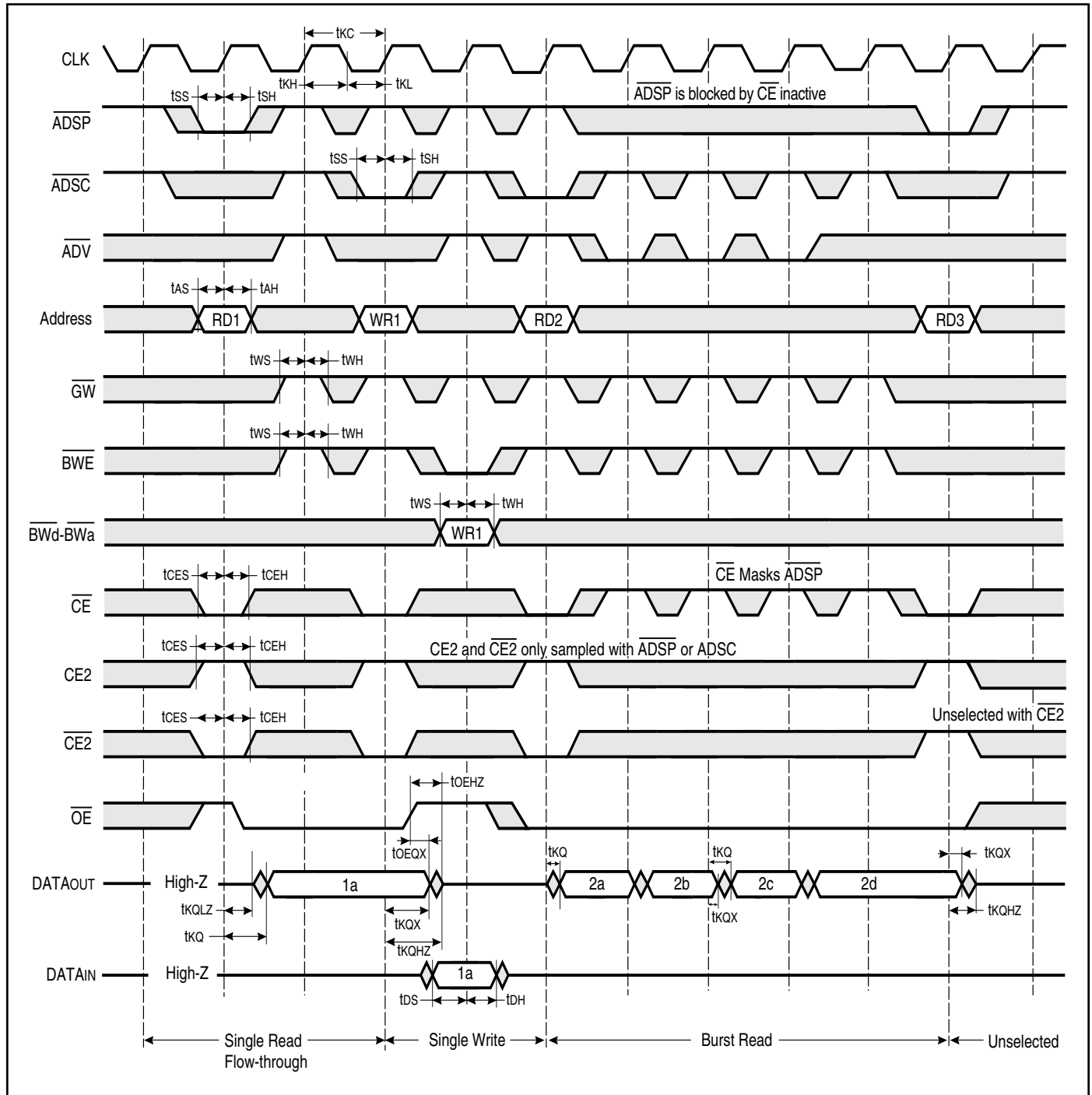

**WRITE CYCLE TIMING**

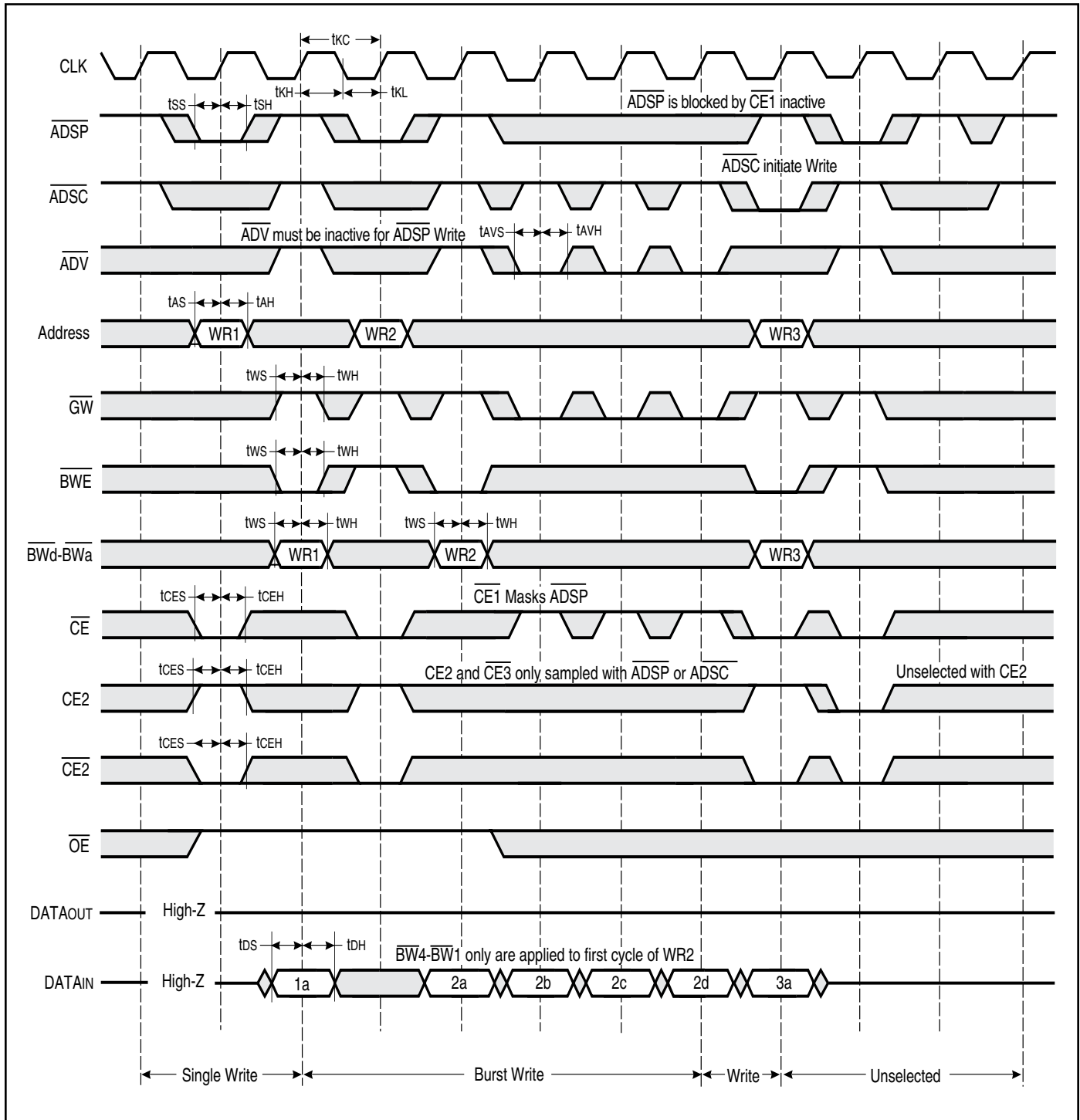

### SNOOZE MODE ELECTRICAL CHARACTERISTICS

Symbol	Parameter	Conditions	Min.	Max.	Unit
ISB2	Current during SNOOZE MODE	ZZ ≥ Vih	—	60	mA
tPDS	ZZ active to input ignored		—	2	cycle
tPUS	ZZ inactive to input sampled		2	—	cycle
tZZI	ZZ active to SNOOZE current		—	2	cycle
tRZZI	ZZ inactive to exit SNOOZE current		0	—	ns

### SNOOZE MODE TIMING





**ORDERING INFORMATION (V<sub>DD</sub> = 3.3V/V<sub>DDQ</sub> = 2.5V/3.3V)**

**Commercial Range: 0°C to +70°C**

Configuration	Access Time	Order Part Number	Package
128Kx32	6.5	IS61LF12832A-6.5TQ	100 TQFP
		IS61LF12832A-6.5B2	119 PBGA
		IS61LF12832A-6.5B3	165 PBGA
128Kx32	7.5	IS61LF12832A-7.5TQ	100 TQFP
		IS61LF12832A-7.5B2	119 PBGA
		IS61LF12832A-7.5B3	165 PBGA
128Kx36	6.5	IS61LF12836A-6.5TQ	100 TQFP
		IS61LF12836A-6.5B2	119 PBGA
		IS61LF12836A-6.5B3	165 PBGA
128Kx36	7.5	IS61LF12836A-7.5TQ	100 TQFP
		IS61LF12836A-7.5B2	119 PBGA
		IS61LF12836A-7.5B3	165 PBGA
256Kx18	6.5	IS61LF25618A-6.5TQ	100 TQFP
		IS61LF25618A-6.5TQL	100 TQFP, Lead-free
		IS61LF25618A-6.5B2	119 PBGA
		IS61LF25618A-6.5B3	165 PBGA
256Kx18	7.5	IS61LF25618A-7.5TQ	100 TQFP
		IS61LF25618A-7.5B2	119 PBGA
		IS61LF25618A-7.5B3	165 PBGA



**ORDERING INFORMATION (V<sub>DD</sub> = 3.3V/V<sub>DDQ</sub> = 2.5V/3.3V)**

**Industrial Range: -40°C to +85°C**

Configuration	Access Time	Order Part Number	Package
128Kx32	6.5	IS61LF12832A-6.5TQI	100 TQFP
		IS61LF12832A-6.5B2I	119 PBGA
		IS61LF12832A-6.5B3I	165 PBGA
128Kx32	7.5	IS61LF12832A-7.5TQI	100 TQFP
		IS61LF12832A-7.5TQLI	100 TQFP, Lead-free
		IS61LF12832A-7.5B2I	119 PBGA
		IS61LF12832A-7.5B3I	165 PBGA
128Kx36	6.5	IS61LF12836A-6.5TQI	100 TQFP
		IS61LF12836A-6.5TQLI	100 TQFP, Lead-free
		IS61LF12836A-6.5B2I	119 PBGA
		IS61LF12836A-6.5B3I	165 PBGA
128Kx36	7.5	IS61LF12836A-7.5TQI	100 TQFP
		IS61LF12836A-7.5TQLI	100 TQFP, Lead-free
		IS61LF12836A-7.5B2I	119 PBGA
		IS61LF12836A-7.5B3I	165 PBGA
256Kx18	6.5	IS61LF25618A-6.5TQI	100 TQFP
		IS61LF25618A-6.5B2I	119 PBGA
		IS61LF25618A-6.5B3I	165 PBGA
256Kx18	7.5	IS61LF25618A-7.5TQI	100 TQFP
		IS61LF25618A-7.5TQLI	100 TQFP, Lead-free
		IS61LF25618A-7.5B2I	119 PBGA
		IS61LF25618A-7.5B3I	165 PBGA

**Automotive Range: -40°C to +125°C**

Configuration	Access Time	Order Part Number	Package
128Kx32	7.5	IS64LF12832A-7.5TQA3	100 TQFP
		IS64LF12832A-7.5TQLA3	100 TQFP, Lead-free
128Kx36	7.5	IS64LF12836A-7.5TQA3	100 TQFP
		IS64LF12836A-7.5B3LA3	165 PBGA, Lead-free
256Kx18	7.5	IS64LF25618A-7.5TQA3	100 TQFP



**ORDERING INFORMATION (V<sub>DD</sub> = 2.5V /V<sub>DDQ</sub> = 2.5V)**

**Commercial Range: 0°C to +70°C**

Configuration	Access Time	Order Part Number	Package
128Kx36	6.5	IS61VF12836A-6.5TQ	100 TQFP
		IS61VF12836A-6.5B2	119 PBGA
		IS61VF12836A-6.5B3	165 PBGA
128Kx36	7.5	IS61VF12836A-7.5TQ	100 TQFP
		IS61VF12836A-7.5B2	119 PBGA
		IS61VF12836A-7.5B3	165 PBGA
256Kx18	6.5	IS61VF25618A-6.5TQ	100 TQFP
		IS61VF25618A-6.5B2	119 PBGA
		IS61VF25618A-6.5B3	165 PBGA
256Kx18	7.5	IS61VF25618A-7.5TQ	100 TQFP
		IS61VF25618A-7.5B2	119 PBGA
		IS61VF25618A-7.5B3	165 PBGA

**Industrial Range: -40°C to +85°C**

Configuration	Access Time	Order Part Number	Package
128Kx36	6.5	IS61VF12836A-6.5TQI	100 TQFP
		IS61VF12836A-6.5B2I	119 PBGA
		IS61VF12836A-6.5B3I	165 PBGA
128Kx36	7.5	IS61VF12836A-7.5TQI	100 TQFP
		IS61VF12836A-7.5B2I	119 PBGA
		IS61VF12836A-7.5B3I	165 PBGA
256Kx18	6.5	IS61VF25618A-6.5TQI	100 TQFP
		IS61VF25618A-6.5B2I	119 PBGA
		IS61VF25618A-6.5B3I	165 PBGA
256Kx18	7.5	IS61VF25618A-7.5TQI	100 TQFP
		IS61VF25618A-7.5B2I	119 PBGA
		IS61VF25618A-7.5B3I	165 PBGA

**Automotive Range: -40°C to +125°C**

Configuration	Access Time	Order Part Number	Package
128Kx32	7.5	IS64VF12832A-7.5TQLA3	100 TQFP, Lead-free
128Kx36	7.5	IS64VF12836A-7.5TQA3	100 TQFP
256Kx18	7.5	IS64VF25618A-7.5TQA3	100 TQFP

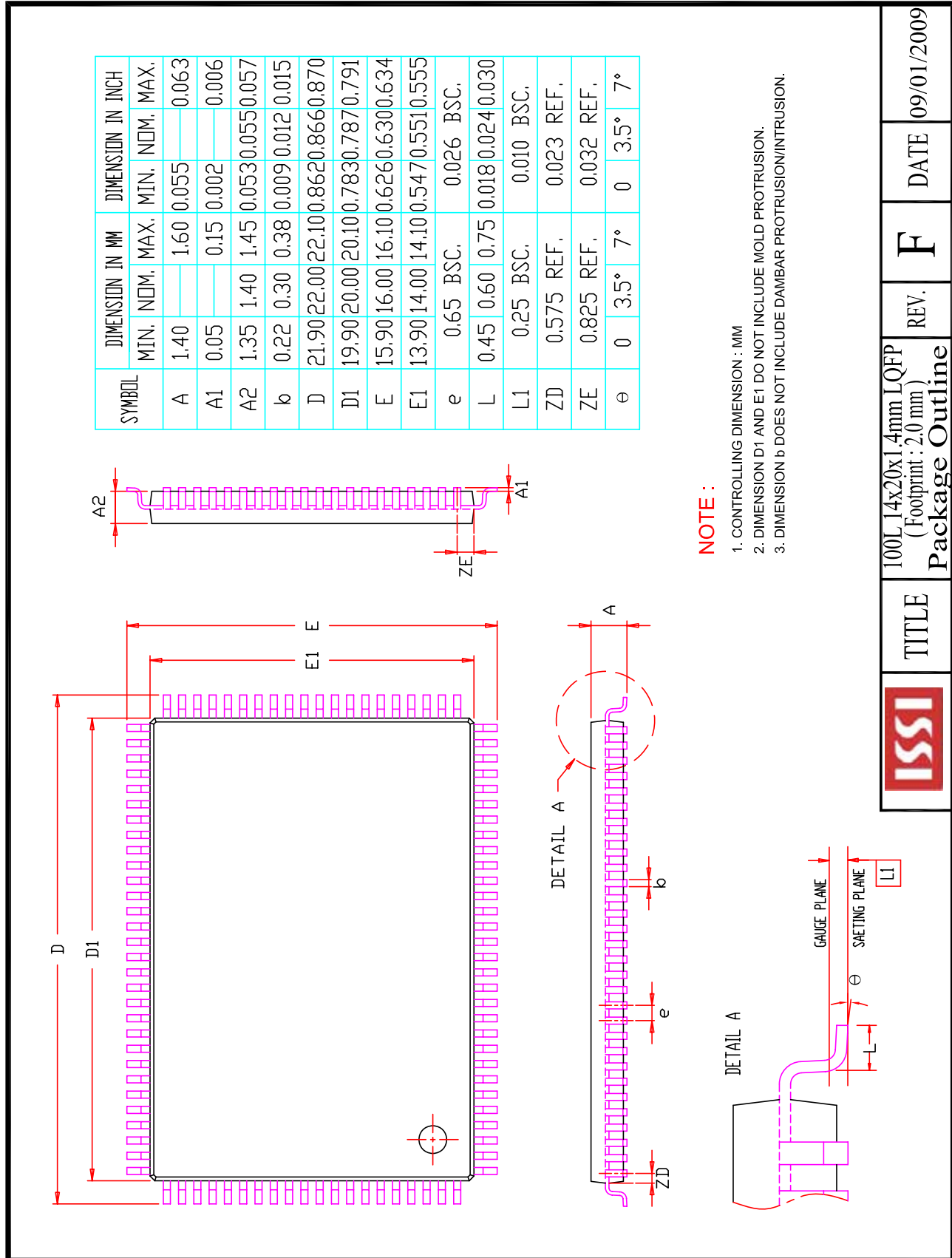

	TITLE	REV.	DATE
	100L14x20x1.4mm LQFP (Footprint : 2.0 mm) Package Outline	F	09/01/2009

280-600-011 REV. A



	TITLE	119L 14x22mm PBGA Package Outline	REV.	D	DATE	10/02/2008
--	-------	--------------------------------------	------	---	------	------------





	TITLE	165L 13x15mm TF-BGA Package Outline	REV.	B	DATE	08/28/2008
--	-------	--	------	---	------	------------

Компания «Океан Электроники» предлагает заключение долгосрочных отношений при поставках импортных электронных компонентов на взаимовыгодных условиях!

Наши преимущества:

- Поставка оригинальных импортных электронных компонентов напрямую с производств Америки, Европы и Азии, а так же с крупнейших складов мира;
- Широкая линейка поставок активных и пассивных импортных электронных компонентов (более 30 млн. наименований);
- Поставка сложных, дефицитных, либо снятых с производства позиций;
- Оперативные сроки поставки под заказ (от 5 рабочих дней);
- Экспресс доставка в любую точку России;
- Помощь Конструкторского Отдела и консультации квалифицированных инженеров;
- Техническая поддержка проекта, помощь в подборе аналогов, поставка прототипов;
- Поставка электронных компонентов под контролем ВП;
- Система менеджмента качества сертифицирована по Международному стандарту ISO 9001;
- При необходимости вся продукция военного и аэрокосмического назначения проходит испытания и сертификацию в лаборатории (по согласованию с заказчиком);
- Поставка специализированных компонентов военного и аэрокосмического уровня качества (Xilinx, Altera, Analog Devices, Intersil, Interpoint, Microsemi, Actel, Aeroflex, Peregrine, VPT, Syfer, Eurofarad, Texas Instruments, MS Kennedy, Miteq, Cobham, E2V, MA-COM, Hittite, Mini-Circuits, General Dynamics и др.);

Компания «Океан Электроники» является официальным дистрибьютором и эксклюзивным представителем в России одного из крупнейших производителей разъемов военного и аэрокосмического назначения «JONHON», а так же официальным дистрибьютором и эксклюзивным представителем в России производителя высокотехнологичных и надежных решений для передачи СВЧ сигналов «FORSTAR».



## JONHON

«JONHON» (основан в 1970 г.)

Разъемы специального, военного и аэрокосмического назначения:

(Применяются в военной, авиационной, аэрокосмической, морской, железнодорожной, горно- и нефтедобывающей отраслях промышленности)

«FORSTAR» (основан в 1998 г.)

ВЧ соединители, коаксиальные кабели, кабельные сборки и микроволновые компоненты:

(Применяются в телекоммуникациях гражданского и специального назначения, в средствах связи, РЛС, а так же военной, авиационной и аэрокосмической отраслях промышленности).



Телефон: 8 (812) 309-75-97 (многоканальный)

Факс: 8 (812) 320-03-32

Электронная почта: [ocean@oceanchips.ru](mailto:ocean@oceanchips.ru)

Web: <http://oceanchips.ru/>

Адрес: 198099, г. Санкт-Петербург, ул. Калинина, д. 2, корп. 4, лит. А