

Sensor Evaluation Kit, SEK001

For Use with TruStability™ RSC Series and Digital Output Versions of the HSC Series and SSC Series Board Mount Pressure Sensors

32330034

Issue A

Datasheet

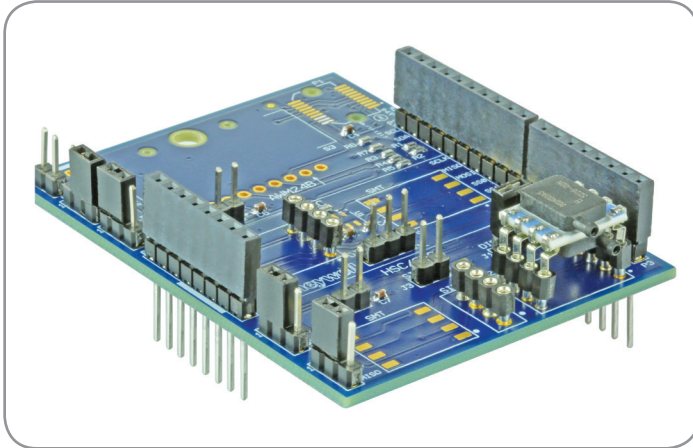

DESCRIPTION

The Sensor Evaluation Kit, SEK001, provides an easier way to demonstrate and evaluate Honeywell's TruStability RSC Series, and the digital output versions (I²C or SPI) of the HSC Series and SSC Series Board Mount Pressure Sensors. The kit interfaces a selected sensor to an Arduino™ Uno Rev3 Microcontroller Board. Honeywell software, which is provided free and is downloadable at <http://sensing.honeywell.com/sensors/evaluation-kit>, controls the Arduino Uno Rev3 to take readings from the sensor. Sensor measurements are displayed on the user's PC and can be recorded to a .csv file for further analysis. In addition to being mounted directly on the SEK001, the sensor may also be remotely connected to the SEK001 via wire leads, allowing the sensor to be tested in adverse environments, or in a prototype product for proof of concept testing.

VALUE TO CUSTOMERS

- Quicker, easier TruStability pressure sensor evaluation: The SEK001 and associated Honeywell software simplify sensor evaluation and demonstration by eliminating the need for the customer to develop any code before seeing sensor measurements.
- Remote mounting: In addition to being mounted on the SEK001, the sensor may also be mounted remotely if, for example, it is to be mounted in an oven for testing or in a prototype product for proof-of-concept testing of the customer's end product.
- Cost-effective: Provides a cost-effective way learn about the capabilities of our sensors so customers can make better informed component decisions faster. Customers are then able to perform a thorough evaluation of the sensor without needing to develop additional code.
- Expedites development: As the SEK001 allows customers to test their product, this helps customers to expedite their development process.

FEATURES

- The SEK001 has sockets to receive TruStability HSC, SSC Series pressure sensors with I²C or SPI digital output, as well as the new TruStability RSC Series high resolution pressure sensors. The board is then plugged in as a shield board to the user-provided Arduino Uno Rev3 board. (All sensors are sold separately. Only one sensor may be evaluated at a time.)
- Five jumpers for an HSC Series or SSC Series, I²C output, 5 Vdc pressure sensor are preconfigured on the board.
- Uses an industry standard Arduino platform
- Sensor Evaluation Boards for other Honeywell sensors are under development

POTENTIAL APPLICATIONS

- Sensor demonstration
- Sensor testing and evaluation
- Proof-of-concept testing

Sensor Evaluation Kit, SEK001

Table 1. Sensor Evaluation Kit Contents and User-Provided Items





Honeywell Sensor Evaluation Kit, SEK001	User-Provided Components
<p>Includes:</p> <ul style="list-style-type: none"> • Sensor Evaluation Board • Five jumpers for HSCDRRN001ND2A5 preconfigured on board 	<p>Arduino Uno Rev3 Microcontroller Board (A000066)</p>  <p>USB Interface Cable (Type A Male to Type B Male)</p>  <p>PC with Internet access (Note: If using a docking station computer, ensure that the computer is not in its docking station when installing and running the software.)</p> 

Table 2. SEK001 Associated Pressure Sensors

RSC Series—High Resolution, High Accuracy, Compensated/Amplified	HSC Series—High Accuracy, Compensated/Amplified	SSC Series—Standard Accuracy, Compensated/Amplified
<p>24-bit Digital SPI-compatible output</p> <p>DIP, SMT packages</p> 	<p>Digital output versions only</p> <p>SPI, I²C: DIP, SMT packages I²C: SIP packages</p> 	<p>Digital output versions only</p> <p>SPI, I²C: DIP, SMT packages I²C: SIP packages</p> 

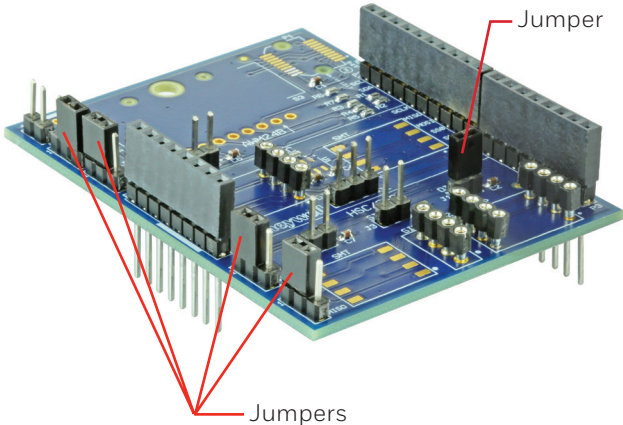
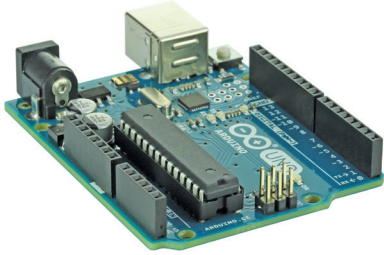
Sensor Evaluation Kit, SEK001

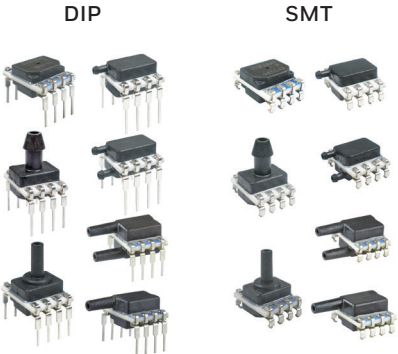
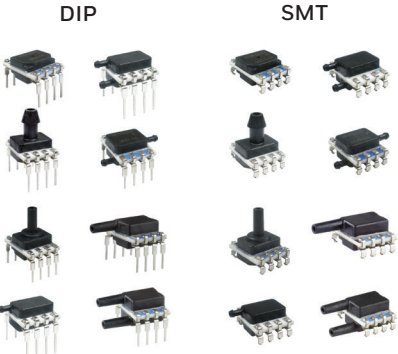
Figure 1. SEK001/Arduino Assembly

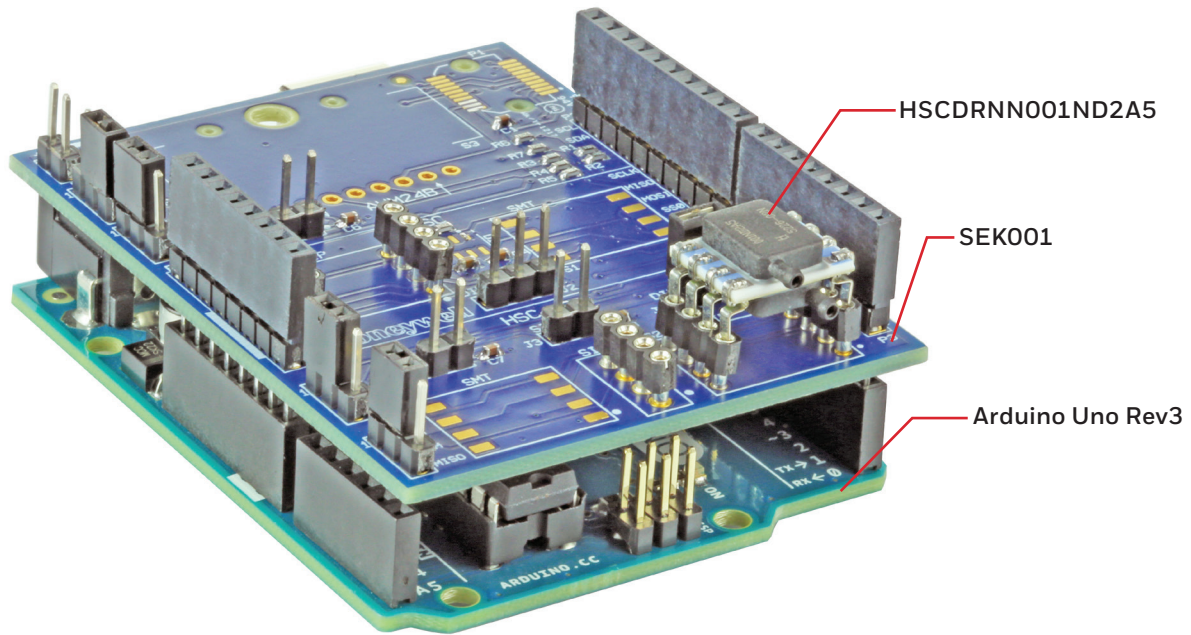

Table 3. SEK001 Specifications

Characteristic	Parameter
Temperature range	20°C to 30°C [68°F to 86°F]
Humidity range	30 %RH to 70 %RH
Power supply: internal (Arduino) external	3.3V or 5V 3.3V or 5V
Compatible sensors	RSC Series HSC Series (digital versions only) SSC Series (digital versions only)
Associated software	Sensor Evaluation Kit SEK001 Version 1.0.exe Arduino Firmware SEK001 Version 1.0.zip XLoader.zip

Sensor Evaluation Kit, SEK001

Figure 2. Measurement Screen for HSC, SSC Series Only

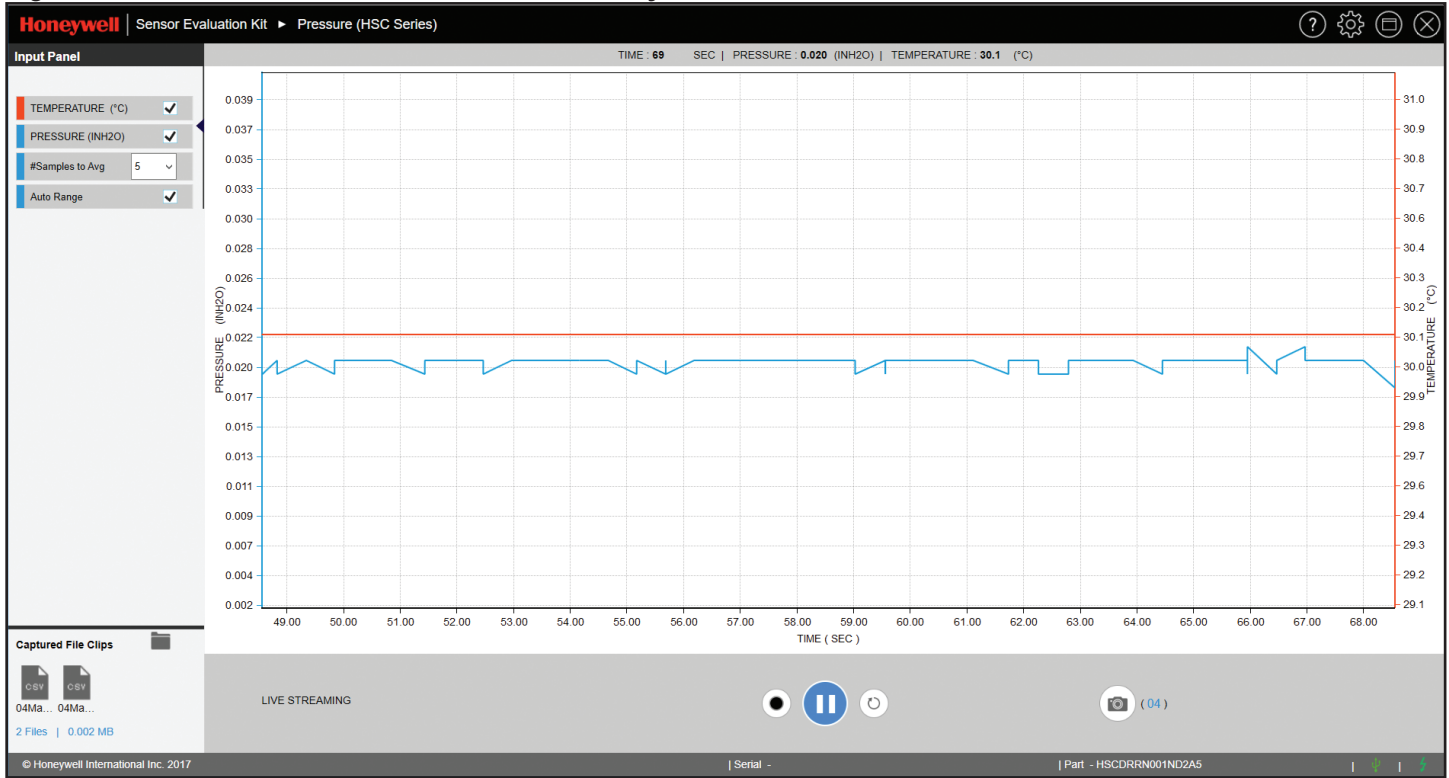
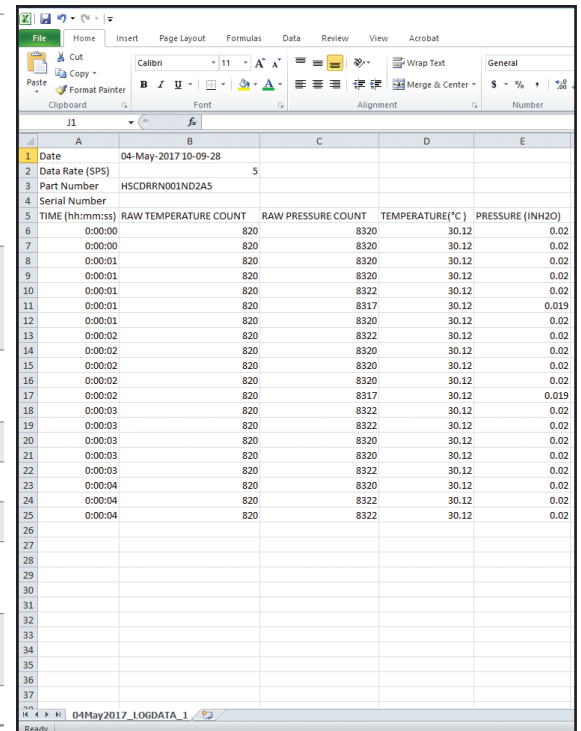

Table 4. Measurement Screen Functions for HSC, SSC Series Only

Function	Description
Input Panel:	Selects the desired graph parameters. Click on the “Play” button after making a selection to restart the evaluation.
Temperature	Displays °C or °F of the sensor’s ASIC.
Pressure	Displays the sensor’s pressure.
#Samples to Avg.	Select from the given number.
Auto Range	Select to automatically adjust to keep trace on screen.
Play/Pause	Starts/pauses the LIVE STREAMING function. Also used to restart an evaluation after changing any Input Panel characteristics.
Record	Records the measurements in a .csv file in Excel for offline analysis.
Restart	Resets the time line to 0 sec.
Snap Shot	Saves a screenshot to a selected folder.
Saved Snaps Path	Opens the folder of recent file clips and snap shots.
Captured File Clips	Displays/provides access to recent .csv files in Excel.
Part	Displays the part number of the sensor currently being evaluated.
Serial	Not displayed.

Figure 3. Captured File Clip Sample for HSC, SSC Series Only



Sensor Evaluation Kit, SEK001

Figure 4. Measurement Screen for RSC Series Only

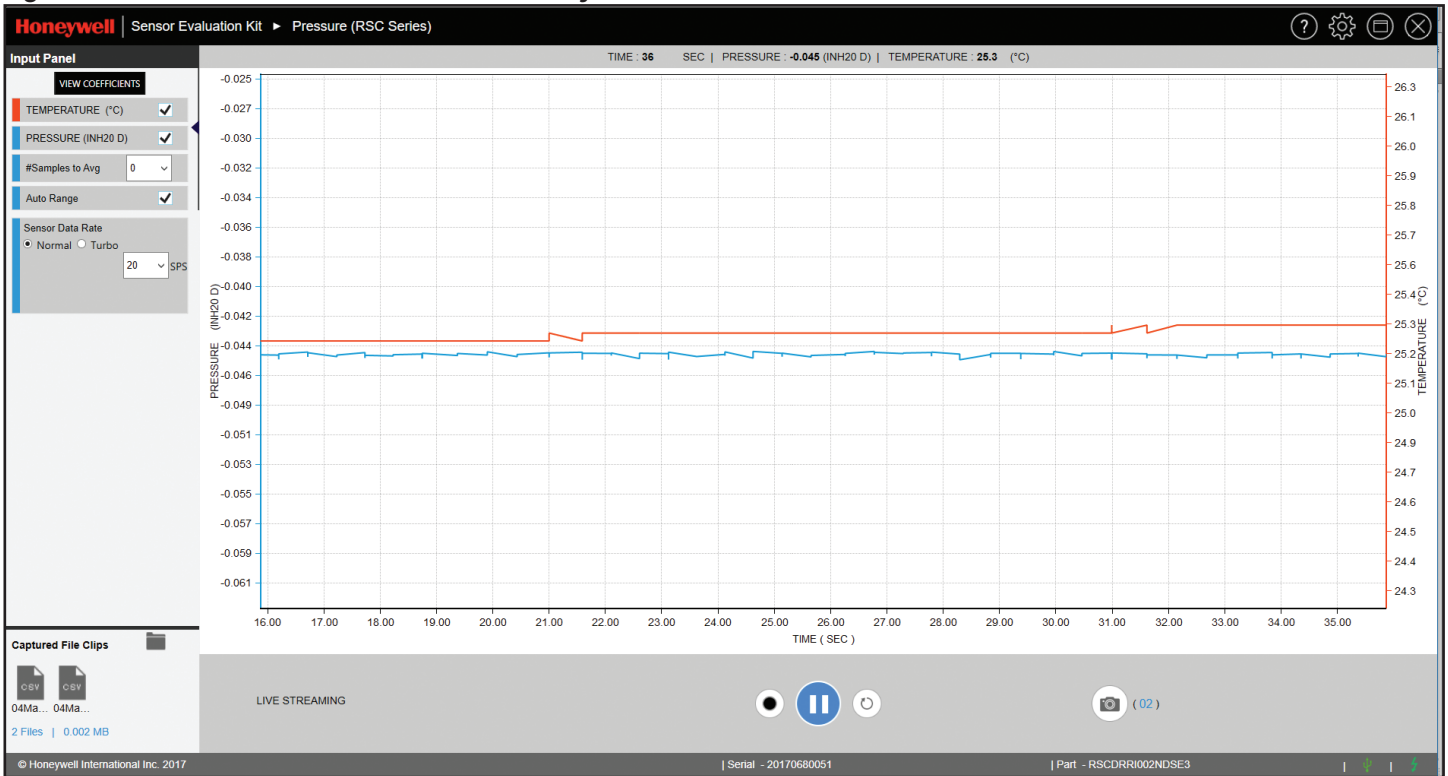

Table 5. Measurement Screen Functions for RSC Series Only

Function	Description
Input Panel:	Selects the desired graph parameters. Click on the “Play” button after making a selection to restart the evaluation.
VIEW COEFFICIENTS	Displays 12 coefficients, as well as other data (see Figure 10).
Temperature	Displays temperature in °C or °F of the sensor’s ASIC.
Pressure	Displays the sensor’s pressure.
#Samples to Avg	Select from a given number.
Auto Range	Select to automatically adjust scale to keep trace on screen.
Sensor Data Rate	Select from a given number the rate at which the sensor is programmed to make successive readings.
Play/Pause	Starts/pauses the LIVE STREAMING function. Also used to restart an evaluation after changing any Input Panel characteristics.
Record	Records the measurements in a .csv file in Excel for offline analysis.
Restart	Resets the time line to 0 sec.
Snap Shot	Saves a screen shot to a selected folder.
Saved Snaps Path	Opens the folder of recent file clips and snap shots.
Captured File Clips	Displays/provides access to recent .csv files in Excel format.
Part	Displays the part number of the sensor currently being evaluated.
Serial	Displays the serial number of the sensor currently being evaluated.

Sensor Evaluation Kit, SEK001

Figure 5. Captured File Clip Sample for RSC Series Only

	A	B	C	D	E	F	G
1	Date	04-May-2017 10-48-46		TE03: -525555.7	TE02: 15.06208	TE01: 0.002973723	TE00: -3.581009E-07
2	Data Rate (SPS)	5		TES3: 2234052	TES2: -185.6375	TES1: 0.009351089	TES0: -1.918478E-08
3	Part Number	RSCDRRI002NDSE3		PS3: 0.4999541	PS2: 0.997693	PS1: -0.002024277	PS0: 0.008609019
4	Serial Number	20170680051					
5	TIME (hh:mm:ss)	RAW TEMPERATURE COUNT	RAW PRESSURE COUNT	TEMPERATURE(°C)	PRESSURE (INH20 D)		
6	0:00:00	818	-534849	25.5625	-0.044914484		
7	0:00:00	818	-535027	25.5625	-0.045254588		
8	0:00:01	818	-534916	25.5625	-0.045042515		
9	0:00:01	818	-534898	25.5625	-0.045008063		
10	0:00:01	818	-535093	25.5625	-0.045380712		
11	0:00:01	818	-534920	25.5625	-0.045050144		
12	0:00:01	818	-535030	25.5625	-0.04526031		
13	0:00:02	818	-534997	25.5625	-0.045197248		
14	0:00:02	818	-534921	25.5625	-0.045052052		
15	0:00:02	818	-535041	25.5625	-0.045281291		
16	0:00:02	818	-534841	25.5625	-0.044899106		
17	0:00:02	818	-534918	25.5625	-0.045046329		
18	0:00:03	818	-534887	25.5625	-0.044987082		
19	0:00:03	818	-534806	25.5625	-0.04483223		
20	0:00:03	818	-534982	25.5625	-0.045168638		
21	0:00:03	818	-534851	25.5625	-0.044918299		
22	0:00:03	818	-534866	25.5625	-0.044946909		
23	0:00:04	818	-535008	25.5625	-0.045218229		
24	0:00:04	818	-534921	25.5625	-0.045052052		
25	0:00:04	818	-535062	25.5625	-0.045321465		
26	0:00:04	818	-534939	25.5625	-0.045086384		
27	0:00:04	818	-534936	25.5625	-0.045080662		

Figure 6. View Coefficients Screen for RSC Series Only

EEPROM COEFFICIENTS			
OFFSET COEFFICIENTS			
OffsetCoefficient0	OffsetCoefficient1	OffsetCoefficient2	OffsetCoefficient3
-525555.7	15.06208	0.002973723	-3.581009E-07
SPAN COEFFICIENTS			
SpanCoefficient0	SpanCoefficient1	SpanCoefficient2	SpanCoefficient3
2234052	-185.6375	0.009351089	-1.918478E-08
PRESSURE COEFFICIENTS			
ShapeCoefficient0	ShapeCoefficient1	ShapeCoefficient2	ShapeCoefficient3
0.4999541	0.997693	-0.002024277	0.008609019

Sensor Evaluation Kit, SEK001

Figure 7. SEK001 Dimensions (For reference only: mm/[in].)

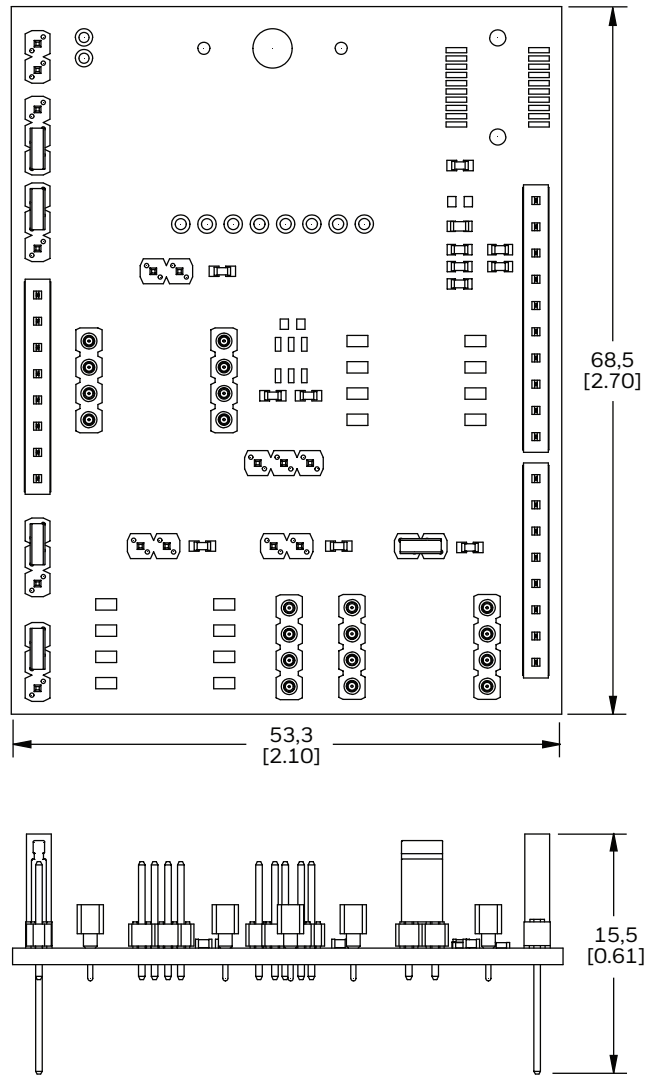

Sensor Evaluation Kit, SEK001

Figure 8. SEK001 Board Layout (Note: The AWM24B set of receiving sockets is not currently used.)

Front (no jumpers shown)

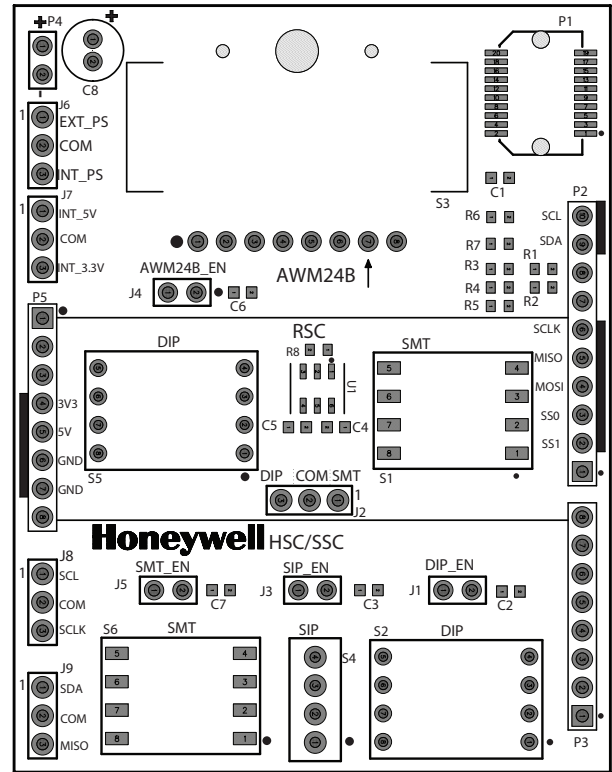
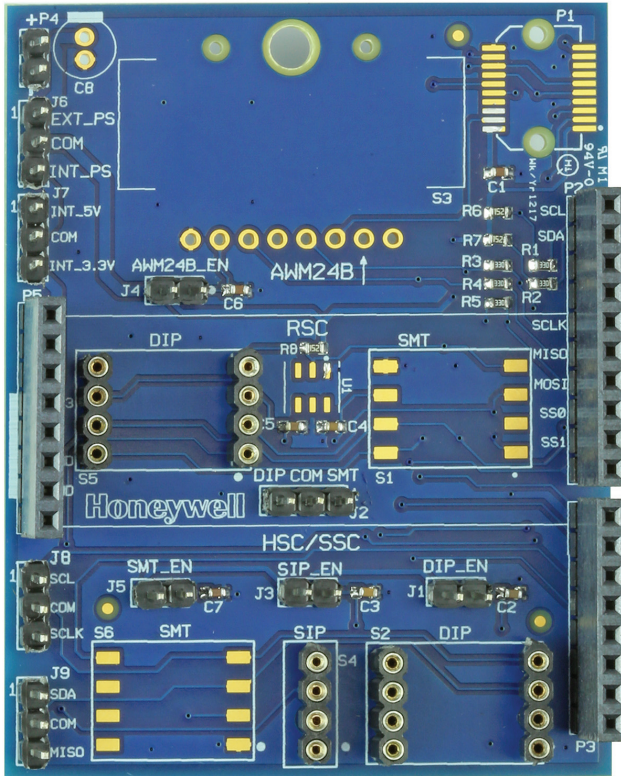

Back

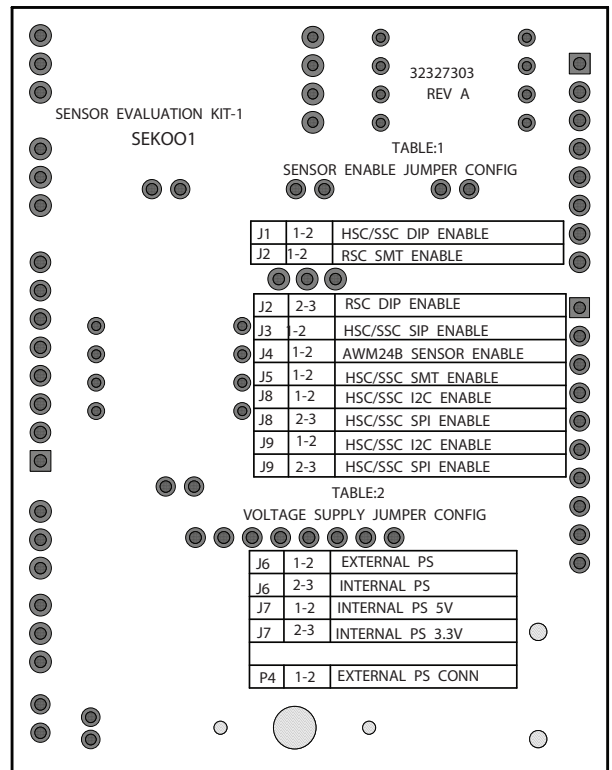
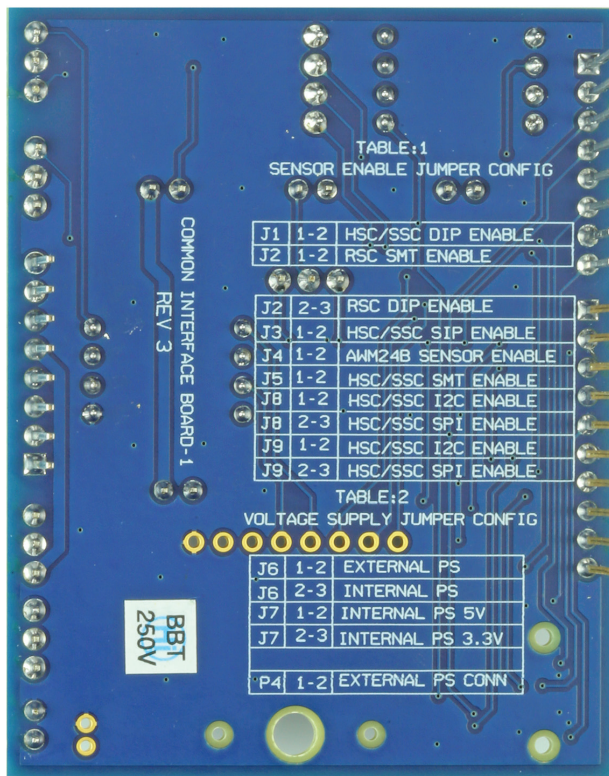

ADDITIONAL INFORMATION

The following associated literature is available on the Honeywell web site at sensing.honeywell.com:

- Product User Instructions

Find out more

Honeywell serves its customers through a worldwide network of sales offices and distributors. For application assistance, current specifications, pricing or name of the nearest Authorized Distributor, contact your local sales office.

To learn more about Honeywell's sensing and switching products, call +1.815.235.6847 or 1.800.537.6945, visit sensing.honeywell.com, or e-mail inquiries to info.sc@honeywell.com

⚠ WARNING **PERSONAL INJURY**

DO NOT USE these products as safety or emergency stop devices or in any other application where failure of the product could result in personal injury.

Failure to comply with these instructions could result in death or serious injury.

⚠ WARNING **MISUSE OF DOCUMENTATION**

- The information presented in this datasheet is for reference only. Do not use this document as a product installation guide.
- Complete installation, operation, and maintenance information is provided in the instructions supplied with each product.

Failure to comply with these instructions could result in death or serious injury.

Warranty/Remedy

Honeywell warrants goods of its manufacture as being free of defective materials and faulty workmanship during the applicable warranty period. Honeywell's standard product warranty applies unless agreed to otherwise by Honeywell in writing; please refer to your order acknowledgement or consult your local sales office for specific warranty details. If warranted goods are returned to Honeywell during the period of coverage, Honeywell will repair or replace, at its option, without charge those items that Honeywell, in its sole discretion, finds defective. **The foregoing is buyer's sole remedy and is in lieu of all other warranties, expressed or implied, including those of merchantability and fitness for a particular purpose. In no event shall Honeywell be liable for consequential, special, or indirect damages.**

While Honeywell may provide application assistance personally, through our literature and the Honeywell web site, it is buyer's sole responsibility to determine the suitability of the product in the application.

Specifications may change without notice. The information we supply is believed to be accurate and reliable as of this writing. However, Honeywell assumes no responsibility for its use.

Honeywell Sensing and Internet of Things

9680 Old Baires Road
Fort Mill, SC 29707
www.honeywell.com

32330034-A-EN | A | 06/17
© 2017 Honeywell International Inc.

Honeywell

Компания «Океан Электроники» предлагает заключение долгосрочных отношений при поставках импортных электронных компонентов на взаимовыгодных условиях!

Наши преимущества:

- Поставка оригинальных импортных электронных компонентов напрямую с производств Америки, Европы и Азии, а так же с крупнейших складов мира;
- Широкая линейка поставок активных и пассивных импортных электронных компонентов (более 30 млн. наименований);
- Поставка сложных, дефицитных, либо снятых с производства позиций;
- Оперативные сроки поставки под заказ (от 5 рабочих дней);
- Экспресс доставка в любую точку России;
- Помощь Конструкторского Отдела и консультации квалифицированных инженеров;
- Техническая поддержка проекта, помощь в подборе аналогов, поставка прототипов;
- Поставка электронных компонентов под контролем ВП;
- Система менеджмента качества сертифицирована по Международному стандарту ISO 9001;
- При необходимости вся продукция военного и аэрокосмического назначения проходит испытания и сертификацию в лаборатории (по согласованию с заказчиком);
- Поставка специализированных компонентов военного и аэрокосмического уровня качества (Xilinx, Altera, Analog Devices, Intersil, Interpoint, Microsemi, Actel, Aeroflex, Peregrine, VPT, Syfer, Eurofarad, Texas Instruments, MS Kennedy, Miteq, Cobham, E2V, MA-COM, Hittite, Mini-Circuits, General Dynamics и др.);

Компания «Океан Электроники» является официальным дистрибьютором и эксклюзивным представителем в России одного из крупнейших производителей разъемов военного и аэрокосмического назначения «JONHON», а так же официальным дистрибьютором и эксклюзивным представителем в России производителя высокотехнологичных и надежных решений для передачи СВЧ сигналов «FORSTAR».



JONHON

«JONHON» (основан в 1970 г.)

Разъемы специального, военного и аэрокосмического назначения:

(Применяются в военной, авиационной, аэрокосмической, морской, железнодорожной, горно- и нефтедобывающей отраслях промышленности)

«FORSTAR» (основан в 1998 г.)

ВЧ соединители, коаксиальные кабели,
кабельные сборки и микроволновые компоненты:

(Применяются в телекоммуникациях гражданского и специального назначения, в средствах связи, РЛС, а так же военной, авиационной и аэрокосмической отраслях промышленности).



Телефон: 8 (812) 309-75-97 (многоканальный)

Факс: 8 (812) 320-03-32

Электронная почта: ocean@oceanchips.ru

Web: <http://oceanchips.ru/>

Адрес: 198099, г. Санкт-Петербург, ул. Калинина, д. 2, корп. 4, лит. А