







## Cylindrical 16-dia. Indicator

- Same basic design as the A16 Pushbutton Switch.

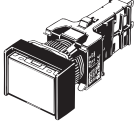

 Refer to *Safety Precautions for All Pushbutton Switches and Safety Precautions* on page 11.

## List of Models

	Appearance	Model
Solder terminals	Rectangular 	M16-J
	Square 	M16-A
	Round 	M16-T
Voltage-reduction lighting		M16-□
Screw-less Clamp		M16-□

## Model Number Structure

**Model Number Legend** ..... The model numbers used to order sets of Units are illustrated below. One set comprises the Display, Case, Lamp, and Socket.

For information on combinations, refer to *Ordering Information* on the following pages.

(1)
(2)
(3)
(4)
(5)  
**M 1 6 5 - T R - 24D - S**

**(1) Degree of Protection**

Symbol	Protection
No symbol	IP40
5	IP65 oil-resistant

**(2) Shape of Display**

Symbol	Shape
J	Rectangular
A	Square
T	Round

**(3) Color of Display**

Symbol	Color
R	Red
G	Green
Y	Yellow
PY	Pure yellow
W	White
PW	Pure white
A	Blue

**(4) Light Source**

Symbol	Type	Operating voltage	Rated voltage
5 12 24	Incandescent lamp	5 VAC/VDC	6 VAC/VDC
		12 VAC/VDC	14 VAC/VDC
		24 VAC/VDC	28 VAC/VDC
5D 12D 24D	LED	5 ±5% VDC	5 VDC
		12 ±5% VAC/VDC	12 VAC/VDC
		24 ±5% VAC/VDC	24 VAC/VDC

**(5) Terminal Type**

Symbol	Terminal type
No symbol	Solder terminals
S	Screw-less Clamp

**Voltage Reduction Unit (24-V Built-in LED)**

Symbol	Type	Operating voltage	Rated voltage
T1	LED	100/110 VAC/VDC	110 VAC/VDC
T2		200/220 VAC/VDC	220 VAC/VDC

- Color illuminated models are also available (see page 4).
- Order the parts separately.
- Solder terminals are available only with 100-V models.
- Screw-less clamp connectors are used for 200-V models.

**Sets** ..... Select an Operation Unit Set (Operation Unit and Case) and a Socket Unit Set (Lamp and Socket Unit).



## Ordering Information

**Ordering as a Set** ..... The model numbers used to order sets of Units are given in the following tables. One set comprises the Display, Case, Lamp, and Socket.

### M16□-J (Rectangular) Models

#### Solder Terminal Models

Appearance	Lighting	Degree of protection	IP40	IP65 oil-resistant	Display color symbol *
Rectangular (M16-J) 	LED without Voltage Reduction Unit	5 VDC	<b>M16-J□-5D</b>	<b>M165-J□-5D</b>	R: red Y: yellow G: green A: blue W: white PY: pure yellow PW: pure white
		12 VAC/VDC	<b>M16-J□-12D</b>	<b>M165-J□-12D</b>	
		24 VAC/VDC	<b>M16-J□-24D</b>	<b>M165-J□-24D</b>	
	Incandescent lamp	5 VAC/VDC	<b>M16-J□-5</b>	<b>M165-J□-5</b>	R: red Y: yellow G: green A: blue W: white PY: pure yellow
		12 VAC/VDC	<b>M16-J□-12</b>	<b>M165-J□-12</b>	
		24 VAC/VDC	<b>M16-J□-24</b>	<b>M165-J□-24</b>	

\* Enter the desired color symbol into the box in the model number.

### M16□-A (Square) Models

#### Solder Terminal Models

Appearance	Lighting	Degree of protection	IP40	IP65 oil-resistant	Display color symbol *
Square (M16-A) 	LED without Voltage Reduction Unit	5 VDC	<b>M16-A□-5D</b>	<b>M165-A□-5D</b>	R: red Y: yellow G: green A: blue W: white PY: pure yellow PW: pure white
		12 VAC/VDC	<b>M16-A□-12D</b>	<b>M165-A□-12D</b>	
		24 VAC/VDC	<b>M16-A□-24D</b>	<b>M165-A□-24D</b>	
	Incandescent lamp	5 VAC/VDC	<b>M16-A□-5</b>	<b>M165-A□-5</b>	R: red Y: yellow G: green A: blue W: white PY: pure yellow
		12 VAC/VDC	<b>M16-A□-12</b>	<b>M165-A□-12</b>	
		24 VAC/VDC	<b>M16-A□-24</b>	<b>M165-A□-24</b>	

\* Enter the desired color symbol into the box in the model number.

### M16□-T (Round) Models

#### Solder Terminal Models

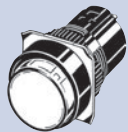
Appearance	Lighting	Degree of protection	IP40	IP65 oil-resistant	Display color symbol *
Round (M16-T) 	LED without Voltage Reduction Unit	5 VDC	<b>M16-T□-5D</b>	<b>M165-T□-5D</b>	R: red Y: yellow G: green A: blue W: white PY: pure yellow PW: pure white
		12 VAC/VDC	<b>M16-T□-12D</b>	<b>M165-T□-12D</b>	
		24 VAC/VDC	<b>M16-T□-24D</b>	<b>M165-T□-24D</b>	
	Incandescent lamp	5 VAC/VDC	<b>M16-T□-5</b>	<b>M165-T□-5</b>	R: red Y: yellow G: green A: blue W: white PY: pure yellow
		12 VAC/VDC	<b>M16-T□-12</b>	<b>M165-T□-12</b>	
		24 VAC/VDC	<b>M16-T□-24</b>	<b>M165-T□-24</b>	

Note: Neon lamps are not available with models that are ordered as a set. They must be ordered individually if required.



\* Enter the desired color symbol into the box in the model number.

Individual models: Refer to pages 4 to 7.  
(The Display, Lamp, Case, and Switch can be ordered separately.)

- Accessories, replacements, and tools: Refer to the A16.
- Ratings and characteristics: Refer to the A16.
- Dimensions: Refer to pages 9 to 10.

## Ordering Information

**Ordering Individually** .....Displays, Cases, Lamps, and Sockets can be ordered separately. Combinations that are not available as sets can be created using individual parts. Also, store the parts as spares for maintenance and repairs.

Display (Refer to page 6.)		
Rectangular 	Square 	Round 

Note: Use IP40 Displays in combination with IP40 Sockets and use IP65 Displays in combination with IP65 Sockets. The Display has a legend plate built in.



Case (Refer to page 7.)

Note: Display Units, which are combinations of Displays and Cases, are also available.



### Lighted Models



Lamp (Refer to page 7.)	
LED 	Incandescent Lamp 



Socket (Refer to page 7.)
Solder Terminals (Without Voltage Reduction Unit)

Note: Socket Units, which are combinations of Lamps and Sockets, are also available.

- For colored illumination, order the Display, Case, Lamp, and Socket Unit separately.

## Ordering Information

**Sets**..... Sets that combined a Display and Cases are also available.

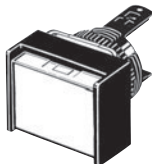
### Display Set

Appearance	Classification		Model
	IP40	Rectangular (2-way guard)	<b>A16-J□M</b>
		Square (2-way guard)	<b>A16-A□M</b>
		Round (projecting model)	<b>A16-T□M</b>
	Oil-resistant IP65	Rectangular (2-way guard)	<b>A165-J□M</b>
		Square (2-way guard)	<b>A165-A□M</b>
		Round (projecting model)	<b>A165-T□M</b>

Insert one of the following symbols into the box in the model number.

Symbol	Color	Remarks
R	Red	LED and incandescent lamps
Y	Yellow	
PY	Pure yellow	
A	Blue	
W	White*	
GY	Green	LED only
G	Green	Incandescent only

\* Use this pushbutton color if the illumination color of the LED is white or pure white.

### Socket Unit Sets with Incandescent Lamps

Appearance	Classification		Model
	5 V	Solder terminals	<b>M16-5</b>
	12 V		<b>M16-12</b>
	24 V		<b>M16-24</b>

### Socket Unit Sets with LEDs

Appearance	Classification	Model
	Solder terminals	<b>M16-1-2</b>

### Socket Unit Sets with Voltage-reduction Lighting (Solder Terminals)

Appearance	Classification	Model
	100/110 VAC/VDC	<b>M16-1-T1</b>

Note: The LED has 24-VAC/VDC circuit built in.

### Socket Unit Sets with Screw-less Clamp Connectors

Appearance	Classification		Model	
	Display	No voltage-reduction lighting	<b>M16-1-2-S</b>	
		Voltage-reduction lighting (See note.)	100/110 VAC/VDC	<b>M16-1-T1-S</b>
			200/220 VAC/VDC	<b>M16-1-T2-S</b>

Note: 1. The LED built into the 100-V model is 24 VAC/VDC.

2. The LED built into the 200-V model is high-intensity 24 VAC/VDC.

Insert symbols into the boxes with circled numbers.

1

Symbol	Color
R	Red
Y	Yellow
A	Blue
W	White
G	Green

2







Symbol	Type	Operating voltage
5D	LED	5 VDC
12D		12 VAC/VDC
24D		24 VAC/VDC

## Ordering Information







**Ordering Individually** .....Displays, Cases, Lamps, and Sockets can be ordered separately. Combinations that are not available as sets can be created using individual parts. Also, store the parts as spares for maintenance and repairs.

### Display

#### For LED-lighted Models

Sealing	IP40			IP65 oil-resistant		
	Rectangular	Square	Round	Rectangular	Square	Round
Appearance						
Color of Display						
Red	A16L-JR	A16L-AR	A16L-TR	A165L-JR	A165L-AR	A165L-TR
Yellow	A16L-JY	A16L-AY	A16L-TY	A165L-JY	A165L-AY	A165L-TY
Pure yellow	A16L-JPY	A16L-APY	A16L-TPY	A165L-JPY	A165L-APY	A165L-TPY
Green	A16L-JGY	A16L-AGY	A16L-TGY	A165L-JGY	A165L-AGY	A165L-TGY
White	A16L-JW	A16L-AW	A16L-TW	A165L-JW	A165L-AW	A165L-TW
Blue	A16L-JA	A16L-AA	A16L-TA	A165L-JA	A165L-AA	A165L-TA

**Incandescent Lamps (With the exception of green, the Units are the same as for LEDs.)**

Sealing	IP40			IP65 oil-resistant		
	Rectangular	Square	Round	Rectangular	Square	Round
Appearance						
Color of Display						
Red	A16L-JR	A16L-AR	A16L-TR	A165L-JR	A165L-AR	A165L-TR
Yellow	A16L-JY	A16L-AY	A16L-TY	A165L-JY	A165L-AY	A165L-TY
Pure yellow	A16L-JPY	A16L-APY	A16L-TPY	A165L-JPY	A165L-APY	A165L-TPY
Green	A16L-JG	A16L-AG	A16L-TG	A165L-JG	A165L-AG	A165L-TG
White	A16L-JW	A16L-AW	A16L-TW	A165L-JW	A165L-AW	A165L-TW
Blue	A16L-JA	A16L-AA	A16L-TA	A165L-JA	A165L-AA	A165L-TA

Ordering set combinations: Refer to page 3.

- Accessories, replacements, and tools: Refer to the A16.
- Ratings and characteristics: Refer to the A16.
- Dimensions: Refer to pages 9 to 10.

## Ordering Information

**Ordering Individually** ..... Displays, Cases, Lamps, and Sockets can be ordered separately. Combinations that are not available as sets can be created using individual parts. Also, store the parts as spares for maintenance and repairs.

### Lamp LED

Color	Operating voltage	High intensity 		
		5 VDC	12 VAC/VDC	24 VAC/VDC
Red		<b>A16-5DSR</b>	<b>A16-12DSR</b>	<b>A16-24DSR</b>
Yellow		<b>A16-5DSY</b>	<b>A16-12DSY</b>	<b>A16-24DSY</b>
Green		<b>A16-5DSG</b>	<b>A16-12DSG</b>	<b>A16-24DSG</b>
White *		<b>A16-5DSW</b>	<b>A16-12DSW</b>	<b>A16-24DSW</b>
Blue		<b>A16-5DA</b>	<b>A16-12DA</b>	<b>A16-24DA</b>
Pure white		<b>A16-5DPW</b>	<b>A16-12DPW</b>	<b>A16-24DPW</b>

\* Use the white LED when the required illumination color is white or pure yellow.

### Incandescent Lamp

Appearance	Operating voltage	Model
	5 VAC/VDC	<b>A16-5</b>
	12 VAC/VDC	<b>A16-12</b>
	24 VAC/VDC	<b>A16-24</b>

### Case

Appearance	Classification		Model number
	IP40	Rectangular	<b>A16-CJM</b>
		Square	<b>A16-CAM</b>
		Round	<b>A16-CTM</b>
	IP65 oil-resistant	Rectangular	<b>A165-CJM</b>
		Square	<b>A165-CAM</b>
		Round	<b>A165-CTM</b>

### Socket

Appearance	Classification			Model number
 Solder terminals	Solder terminals			<b>M16-0</b>
	PCB terminals			<b>M16-0P</b>
	Screw-Less Clamp			<b>M16-S</b>
	Solder terminals	Voltage-reduction lighting	100 V	<b>M16-T1</b>
	Screw-less Clamp		100 V	<b>M16-T1-S</b>
			200 V	<b>M16-T2-S</b>

Ordering set combinations: Refer to page 3.

- Accessories, replacements, and tools: Refer to the A16.
- Ratings and characteristics: Refer to the A16.
- Dimensions: Refer to pages 9 to 10.

## Specifications

### Approved Standard Ratings

#### UL, cUL (File No. E76675)

LED: 24 VDC max.

Incandescent lamp: 24 VDC/VAC max.

Note: Certification has been obtained for the Socket Unit.

For detailed information on individual products that have received certification, consult your supplier.

### Ratings

<b>Ambient operating temperature</b>	-10°C to 55°C (with no icing or condensation)
<b>Ambient operating humidity</b>	35% to 85%RH
<b>Ambient storage temperature</b>	-25°C to 65°C (with no icing or condensation)

### Super-bright LED

Rated voltage	Rated current	Operating voltage	Built-in limiting resistance
5 VDC	8 mA	5 VDC $\pm$ 5%	Red, yellow, white: 300 $\Omega$ Green, blue, pure white: 160 $\Omega$
12 VAC/VDC		12 VAC/VDC $\pm$ 5%	Red, yellow, white: 1 k $\Omega$ Green, blue, pure white: 910 $\Omega$
24 VAC/VDC		24 VAC/VDC $\pm$ 5%	2.4 k $\Omega$

### Incandescent Lamp

Rated voltage	Rated current	Operating voltage
6 VAC/VDC	60 mA	5 VAC/VDC
14 VAC/VDC	40 mA	12 VAC/VDC
28 VAC/VDC	24 mA	24 VAC/VDC

### Characteristics

#### Screw-less Clamp

Item	Type	Screw-less Clamp			
<b>Recommended wire size</b>		0.5 mm <sup>2</sup> twisted wire or 0.8 mm-dia. solid wire			
<b>Usable wires and tensile strength</b>	<b>Twisted wire</b>	0.3 mm <sup>2</sup>	0.5 mm <sup>2</sup>	0.75 mm <sup>2</sup>	1.25 mm <sup>2</sup>
	<b>Solid wire</b>	0.5 mm dia.	0.8 mm dia.	1.0 mm dia.	---
	<b>Tensile strength</b>	10 N	20 N	30 N	40 N
<b>Length of exposed wire</b>		10 $\pm$ 1 mm			
<b>Compliant standards</b>		JIS C 2811 Terminal Blocks for Industrial Use			



## Dimensions (Refer to the A16 for details of panel cutout dimensions.)

(Unit: mm)

### Rectangular

#### M16□-J

#### Solder terminals

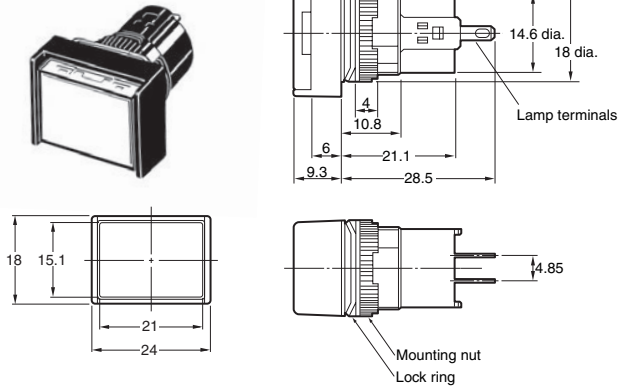

### Square

#### M16□-A

#### Solder terminals



### Round

#### M16□-T

#### Solder terminals

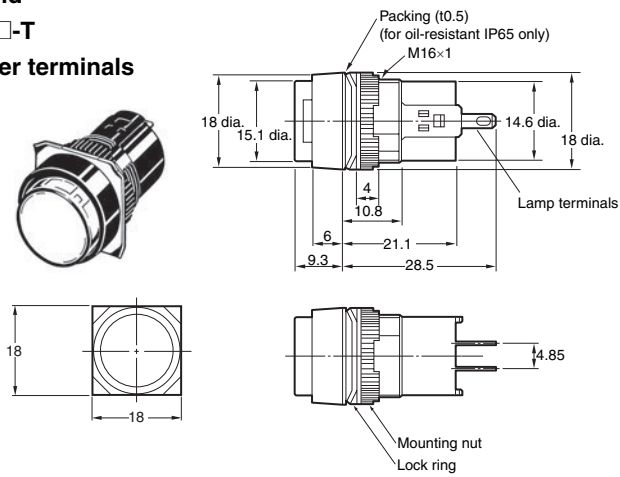

#### Terminal Hole Dimensions



## Dimensions

### Rectangular

#### M16□-J□-T1

Voltage-reduction lighting,  
solder terminals



### Rectangular

#### M16□-J□-S

Screw-less Clamp



## Dimensions

(All units are in millimeters unless otherwise indicated.)

## Terminal Arrangement

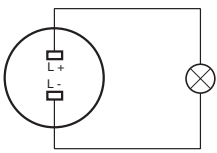
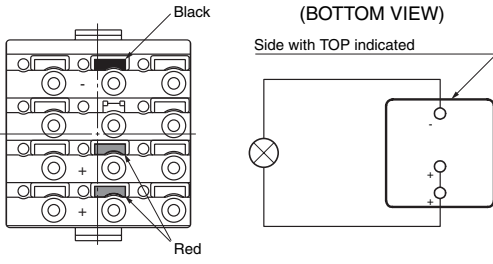
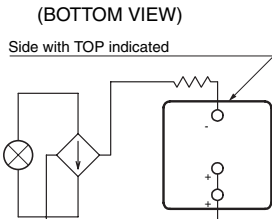
Solder Terminals	Screw-less Clamp	Voltage-reduction Lighting
<p>(BOTTOM VIEW)</p>  <p>The L+ is not shown on the Socket Unit.</p>	<p>(BOTTOM VIEW)</p> 	<p>(BOTTOM VIEW)</p>  <p>Models with voltage-reduction lighting have a circuit to reduce voltage built in.</p>

## Accessories, Replacements, and Tools

The accessories, replacements, and tools are also used with the A16 Pushbutton Switch. Refer to the A16 datasheet.

## Safety Precautions

Refer to *Safety Precautions for All Pushbutton Switches* and *Safety Precautions for the A16*.

### Precautions for Correct Use

#### Mounting

- When mounting the Case onto the Socket Unit, ensure that the orientation is correct. Perform mounting with the dimple on the Case and the TOP mark on the Socket Unit facing in the same direction.

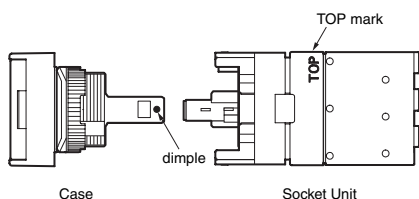

#### Wiring

- When using stranded wire, gather the ends of the strands together before wiring.
- When wiring, insert the wire until it comes into contact with something. After wiring is completed, pull on the wires to confirm that they are connected securely.
- After wiring, ensure that continuous pressure is not applied to the terminals.
- Refer to internal connections diagrams and confirm the terminal numbers before performing wiring.

#### Screw-less Clamps

##### Mounting Procedure

- Strip a length of 10 mm off the end of the wire (allowable range:  $10 \pm 1$  mm).
- Bunch wire strands together and straighten them.
- Insert the wire into the insertion hole while pressing the release button at the side of the hole. (Using a precision screwdriver is recommended.)
- Let go of the release button to lock the wire into place.
- After locking, pull on the wire gently to confirm that it is securely locked.

##### Removing Procedure

- Remove wires by pulling them while pressing the release button.

Note: When reusing wires that have already been locked, cut off the end of the wire and strip the wire again before using.

## Read and Understand This Catalog

Please read and understand this catalog before purchasing the products. Please consult your OMRON representative if you have any questions or comments.

## Warranty and Limitations of Liability

### WARRANTY

OMRON's exclusive warranty is that the products are free from defects in materials and workmanship for a period of one year (or other period if specified) from date of sale by OMRON.

OMRON MAKES NO WARRANTY OR REPRESENTATION, EXPRESS OR IMPLIED, REGARDING NON-INFRINGEMENT, MERCHANTABILITY, OR FITNESS FOR PARTICULAR PURPOSE OF THE PRODUCTS. ANY BUYER OR USER ACKNOWLEDGES THAT THE BUYER OR USER ALONE HAS DETERMINED THAT THE PRODUCTS WILL SUITABLY MEET THE REQUIREMENTS OF THEIR INTENDED USE. OMRON DISCLAIMS ALL OTHER WARRANTIES, EXPRESS OR IMPLIED.

### LIMITATIONS OF LIABILITY

OMRON SHALL NOT BE RESPONSIBLE FOR SPECIAL, INDIRECT, OR CONSEQUENTIAL DAMAGES, LOSS OF PROFITS OR COMMERCIAL LOSS IN ANY WAY CONNECTED WITH THE PRODUCTS, WHETHER SUCH CLAIM IS BASED ON CONTRACT, WARRANTY, NEGLIGENCE, OR STRICT LIABILITY.

In no event shall the responsibility of OMRON for any act exceed the individual price of the product on which liability is asserted.

IN NO EVENT SHALL OMRON BE RESPONSIBLE FOR WARRANTY, REPAIR, OR OTHER CLAIMS REGARDING THE PRODUCTS UNLESS OMRON'S ANALYSIS CONFIRMS THAT THE PRODUCTS WERE PROPERLY HANDLED, STORED, INSTALLED, AND MAINTAINED AND NOT SUBJECT TO CONTAMINATION, ABUSE, MISUSE, OR INAPPROPRIATE MODIFICATION OR REPAIR.

## Application Considerations

### SUITABILITY FOR USE

OMRON shall not be responsible for conformity with any standards, codes, or regulations that apply to the combination of products in the customer's application or use of the products.

At the customer's request, OMRON will provide applicable third party certification documents identifying ratings and limitations of use that apply to the products. This information by itself is not sufficient for a complete determination of the suitability of the products in combination with the end product, machine, system, or other application or use.

The following are some examples of applications for which particular attention must be given. This is not intended to be an exhaustive list of all possible uses of the products, nor is it intended to imply that the uses listed may be suitable for the products:

- Outdoor use, uses involving potential chemical contamination or electrical interference, or conditions or uses not described in this catalog.
- Nuclear energy control systems, combustion systems, railroad systems, aviation systems, medical equipment, amusement machines, vehicles, safety equipment, and installations subject to separate industry or government regulations.
- Systems, machines, and equipment that could present a risk to life or property.

Please know and observe all prohibitions of use applicable to the products.

NEVER USE THE PRODUCTS FOR AN APPLICATION INVOLVING SERIOUS RISK TO LIFE OR PROPERTY WITHOUT ENSURING THAT THE SYSTEM AS A WHOLE HAS BEEN DESIGNED TO ADDRESS THE RISKS, AND THAT THE OMRON PRODUCTS ARE PROPERLY RATED AND INSTALLED FOR THE INTENDED USE WITHIN THE OVERALL EQUIPMENT OR SYSTEM.

### PROGRAMMABLE PRODUCTS

OMRON shall not be responsible for the user's programming of a programmable product, or any consequence thereof.

## Disclaimers

### CHANGE IN SPECIFICATIONS

Product specifications and accessories may be changed at any time based on improvements and other reasons.

It is our practice to change model numbers when published ratings or features are changed, or when significant construction changes are made. However, some specifications of the products may be changed without any notice. When in doubt, special model numbers may be assigned to fix or establish key specifications for your application on your request. Please consult with your OMRON representative at any time to confirm actual specifications of purchased products.

### DIMENSIONS AND WEIGHTS

Dimensions and weights are nominal and are not to be used for manufacturing purposes, even when tolerances are shown.

### PERFORMANCE DATA

Performance data given in this catalog is provided as a guide for the user in determining suitability and does not constitute a warranty. It may represent the result of OMRON's test conditions, and the users must correlate it to actual application requirements. Actual performance is subject to the OMRON Warranty and Limitations of Liability.

### ERRORS AND OMISSIONS

The information in this document has been carefully checked and is believed to be accurate; however, no responsibility is assumed for clerical, typographical, or proofreading errors, or omissions.

2011.1

In the interest of product improvement, specifications are subject to change without notice.

**OMRON Corporation**  
Industrial Automation Company

<http://www.ia.omron.com/>

(c)Copyright OMRON Corporation 2011 All Right Reserved.

Компания «Океан Электроники» предлагает заключение долгосрочных отношений при поставках импортных электронных компонентов на взаимовыгодных условиях!

Наши преимущества:

- Поставка оригинальных импортных электронных компонентов напрямую с производств Америки, Европы и Азии, а так же с крупнейших складов мира;
- Широкая линейка поставок активных и пассивных импортных электронных компонентов (более 30 млн. наименований);
- Поставка сложных, дефицитных, либо снятых с производства позиций;
- Оперативные сроки поставки под заказ (от 5 рабочих дней);
- Экспресс доставка в любую точку России;
- Помощь Конструкторского Отдела и консультации квалифицированных инженеров;
- Техническая поддержка проекта, помощь в подборе аналогов, поставка прототипов;
- Поставка электронных компонентов под контролем ВП;
- Система менеджмента качества сертифицирована по Международному стандарту ISO 9001;
- При необходимости вся продукция военного и аэрокосмического назначения проходит испытания и сертификацию в лаборатории (по согласованию с заказчиком);
- Поставка специализированных компонентов военного и аэрокосмического уровня качества (Xilinx, Altera, Analog Devices, Intersil, Interpoint, Microsemi, Actel, Aeroflex, Peregrine, VPT, Syfer, Eurofarad, Texas Instruments, MS Kennedy, Miteq, Cobham, E2V, MA-COM, Hittite, Mini-Circuits, General Dynamics и др.);

Компания «Океан Электроники» является официальным дистрибьютором и эксклюзивным представителем в России одного из крупнейших производителей разъемов военного и аэрокосмического назначения «JONHON», а так же официальным дистрибьютором и эксклюзивным представителем в России производителя высокотехнологичных и надежных решений для передачи СВЧ сигналов «FORSTAR».



## JONHON

«JONHON» (основан в 1970 г.)

Разъемы специального, военного и аэрокосмического назначения:

(Применяются в военной, авиационной, аэрокосмической, морской, железнодорожной, горно- и нефтедобывающей отраслях промышленности)

«FORSTAR» (основан в 1998 г.)

ВЧ соединители, коаксиальные кабели, кабельные сборки и микроволновые компоненты:

(Применяются в телекоммуникациях гражданского и специального назначения, в средствах связи, РЛС, а так же военной, авиационной и аэрокосмической отраслях промышленности).



Телефон: 8 (812) 309-75-97 (многоканальный)

Факс: 8 (812) 320-03-32

Электронная почта: [ocean@oceanchips.ru](mailto:ocean@oceanchips.ru)

Web: <http://oceanchips.ru/>

Адрес: 198099, г. Санкт-Петербург, ул. Калинина, д. 2, корп. 4, лит. А