



Product Description

The SPF5189Z is a high performance pHEMT MMIC LNA designed for operation from 50 MHz to 4000 MHz. The on-chip active bias network provides stable current over temperature and process threshold voltage variations. The SPF5189Z offers ultra-low noise figure and high linearity performance in a gain block configuration. Its single-supply operation and integrated matching networks make implementation remarkably simple. A high maximum input power specification make it ideal for high dynamic range receivers.

Optimum Technology Matching® Applied

- GaAs HBT
- GaAs MESFET
- InGaP HBT
- SiGe BiCMOS
- Si BiCMOS
- SiGe HBT
- GaAs pHEMT
- Si CMOS
- Si BJT
- GaN HEMT
- InP HBT
- RF MEMS
- LDMOS

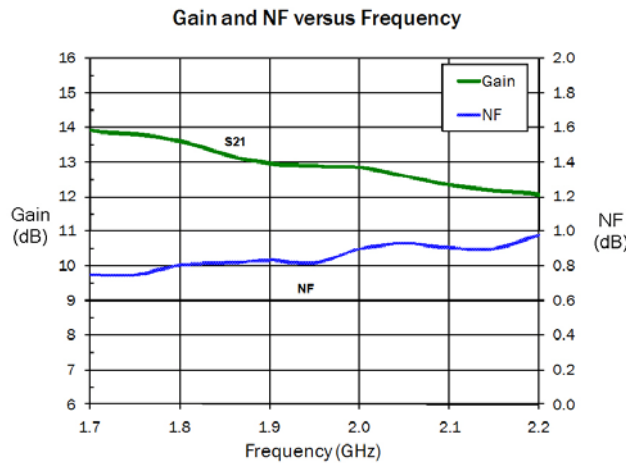

Features

- Ultra-Low Noise Figure=0.60dB at 900MHz
- Gain=18.7dB at 900MHz
- High Linearity: OIP₃=39.5dBm at 1960MHz
- P_{1dB}=22.7 dBm at 1960MHz
- Single-Supply Operation: 5V at I_{DQ}=90mA
- Flexible Biasing Options: 3V to 5V, Adjustable Current
- Broadband Internal Matching

Applications

- Cellular, PCS, W-CDMA, ISM, WiMAX Receivers
- PA Driver Amplifier
- Low Noise, High Linearity Gain Block Applications

Parameter	Specification			Unit	Condition
	Min.	Typ.	Max.		
Small Signal Gain		18.7		dB	0.9GHz
	11.3	12.8	14.3	dB	1.96GHz
Output Power at 1dB Compression		22.4		dBm	0.9GHz
	20.7	22.7		dBm	1.96GHz
Output Third Order Intercept Point		38.5		dBm	0.9GHz
	36.0	39.5		dBm	1.96GHz
Noise Figure		0.55		dB	0.9GHz
		0.8	1.1	dB	1.96GHz
Input Return Loss		17.5		dB	0.9 GHz
	14.5	18.5		dB	1.96GHz
Output Return Loss		16.0		dB	0.9GHz
	11.0	15.0		dB	1.96GHz
Reverse Isolation		24.0		dB	0.9GHz
		18.0		dB	1.96GHz
Device Operating Voltage		5	5.25	V	
Device Operating Current	75	90	105	mA	Quiescent
Thermal Resistance		65		°C/W	Junction to lead

Test Conditions: V_D=5V, I_{DQ}=90mA, TL=25 °C, OIP₃ Tone Spacing=1MHz, P_{OUT} per tone=0dBm
 Z_S=Z_L=50Ω, 25 °C, Application Circuit Data

Absolute Maximum Ratings

Parameter	Rating	Unit
Max Device Current (I_D)	120	mA
Max Device Voltage (V_D)	5.5	V
Max RF Input Power	27	dBm
Max Dissipated Power	660	mW
Max Junction Temperature (T_J)	150	°C
Operating Temperature Range (T_L)	-40 to + 85	°C
Max Storage Temperature	-65 to +150	°C
ESD Rating - Human Body Model (HBM)	Class 1B	
Moisture Sensitivity Level (MSL)	MSL 2	

Operation of this device beyond any one of these limits may cause permanent damage. For reliable continuous operation, the device voltage and current must not exceed the maximum operating values specified in the table on page one.

Bias Conditions should also satisfy the following expression:

$$I_D V_D < (T_J - T_L) / R_{TH, j-l} \text{ and } T_L = T_{LEAD}$$



Caution! ESD sensitive device.

Exceeding any one or a combination of the Absolute Maximum Rating conditions may cause permanent damage to the device. Extended application of Absolute Maximum Rating conditions to the device may reduce device reliability. Specified typical performance or functional operation of the device under Absolute Maximum Rating conditions is not implied.

The information in this publication is believed to be accurate and reliable. However, no responsibility is assumed by RF Micro Devices, Inc. ("RFMD") for its use, nor for any infringement of patents, or other rights of third parties, resulting from its use. No license is granted by implication or otherwise under any patent or patent rights of RFMD. RFMD reserves the right to change component circuitry, recommended application circuitry and specifications at any time without prior notice.



RFMD Green: RoHS compliant per EU Directive 2002/95/EC, halogen free per IEC 61249-2-21, < 1000ppm each of antimony trioxide in polymeric materials and red phosphorus as a flame retardant, and <2% antimony in solder.

Typical RF Performance - Application Circuit Data with $V_D=5V$, $I_D=90mA$

Parameter	Unit	0.8 GHz	0.9 GHz	1.0 GHz	1.7 GHz	1.8 GHz	1.9 GHz	2.0 GHz	2.1 GHz	2.2 GHz
Small Signal Gain	dB	19.6	18.7	17.9	13.8	13.5	12.9	12.7	12.2	11.9
Noise Figure	dB	0.52	0.55	0.79	0.75	0.81	0.83	0.90	0.91	0.98
Output IP3	dBm	38.4	38.5	39.0	39.2	39.5	39.5	39.8	39.8	39.9
Output P1dB	dBm	22.3	22.4	22.5	22.6	22.6	22.7	22.7	22.7	22.7
Input Return Loss	dB	17.1	17.5	17.5	17.5	17.5	18.5	18.5	18.5	18.0
Output Return Loss	dB	16.0	16.0	15.5	14.0	14.0	14.5	15.0	15.5	16.0
Reverse Isolation	dB	24.5	24.0	23.0	18.5	18.5	18.0	18.0	17.5	17.0

Test Conditions: $V_D=5V$, $I_{DQ}=90mA$, OIP₃ Tone Spacing=1MHz, P_{OUT} per tone=0dBm, $T_L=25^\circ C$, $Z_S=Z_L=50\Omega$

Typical RF Performance - 900MHz Application Circuit with $V_D=5V$, $I_D=90mA$

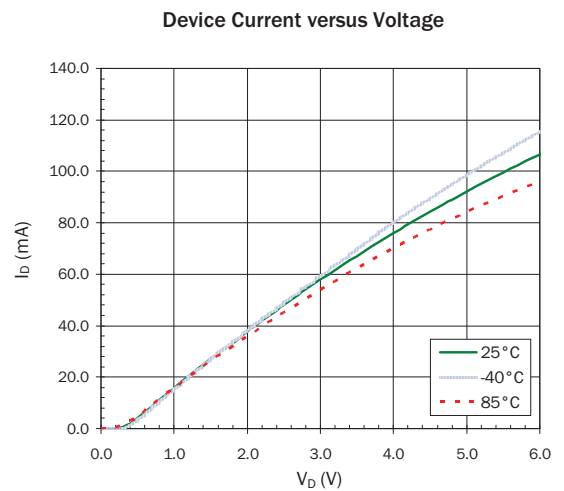
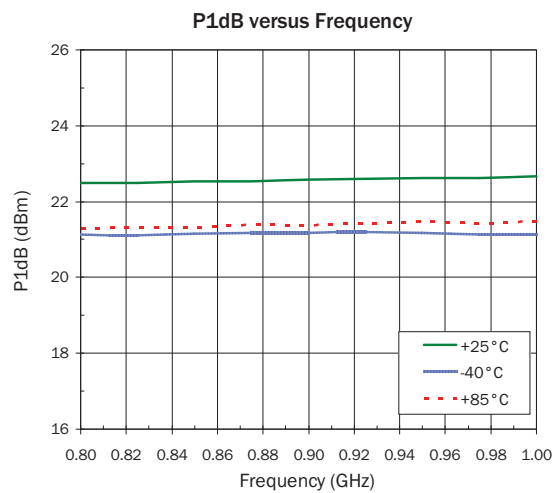
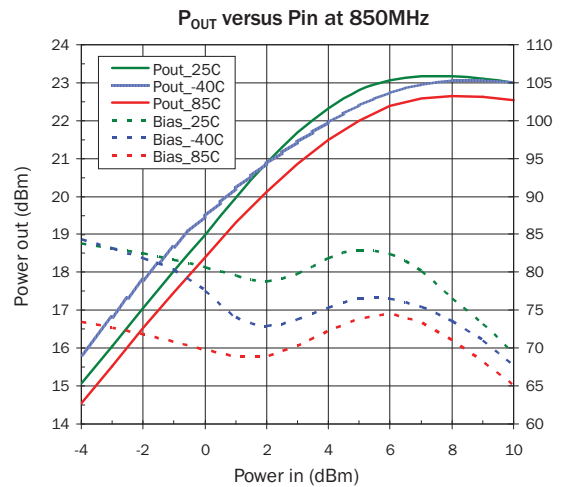
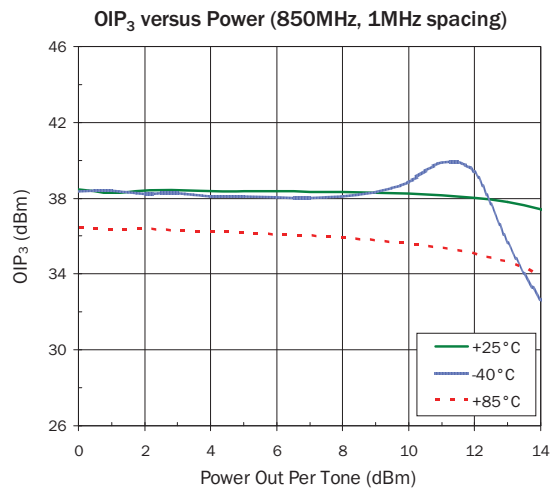
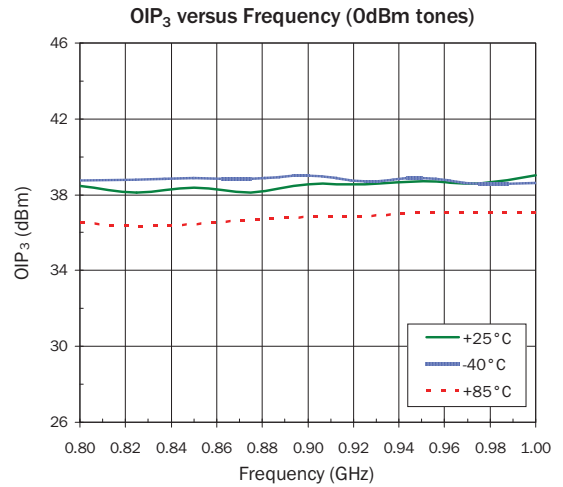
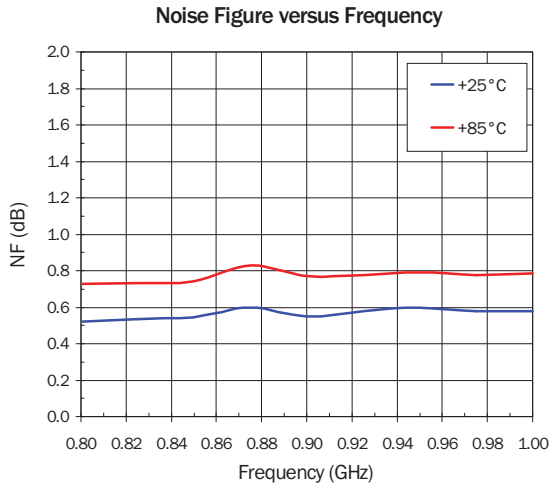

Typical RF Performance - 900MHz Application Circuit with $V_D=5V$, $I_D=90mA$

S11 versus Frequency

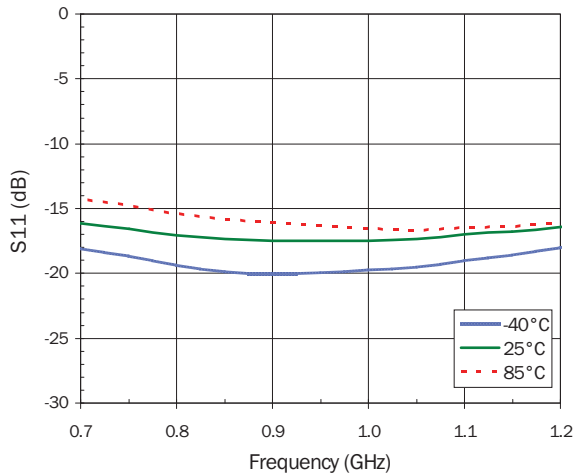

S21 versus Frequency

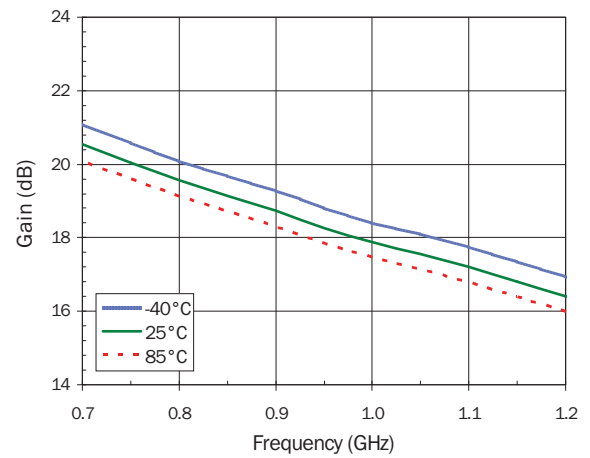

S12 versus Frequency

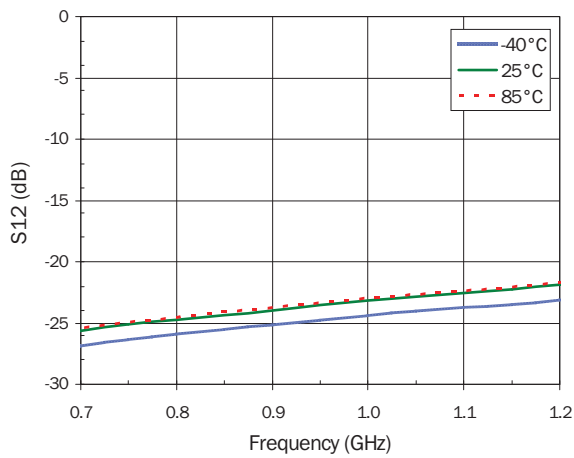

S22 versus Frequency

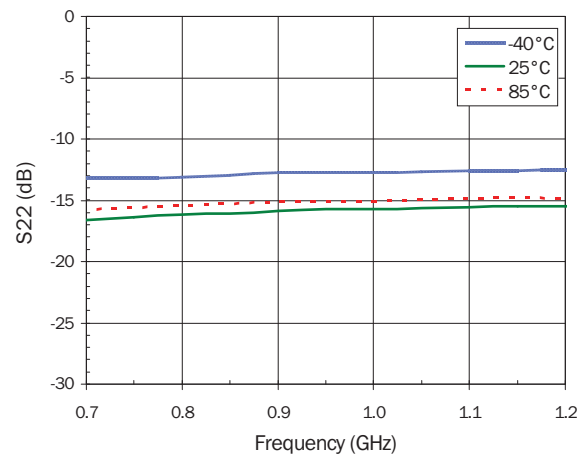

Typical RF Performance - 1900MHz Application Circuit with $V_D=5V$, $I_D=90mA$

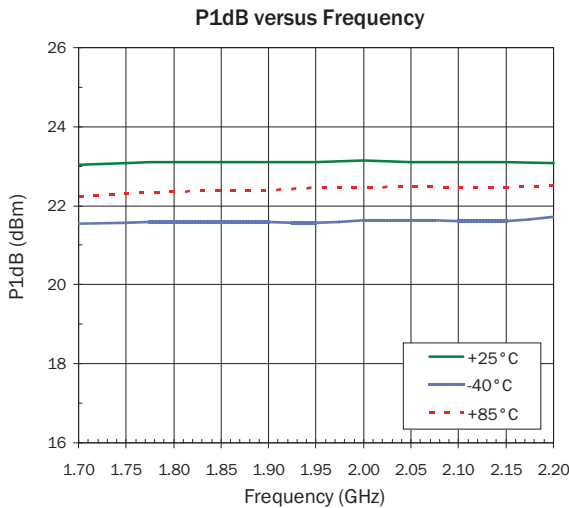
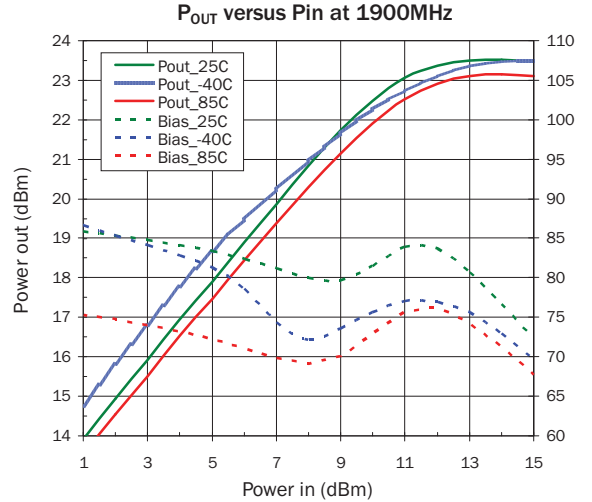
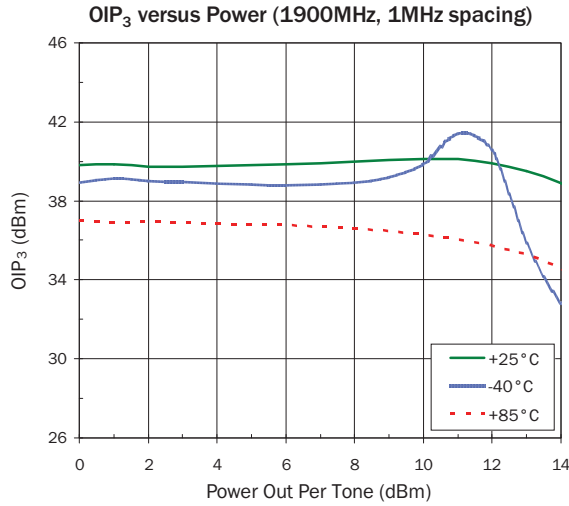
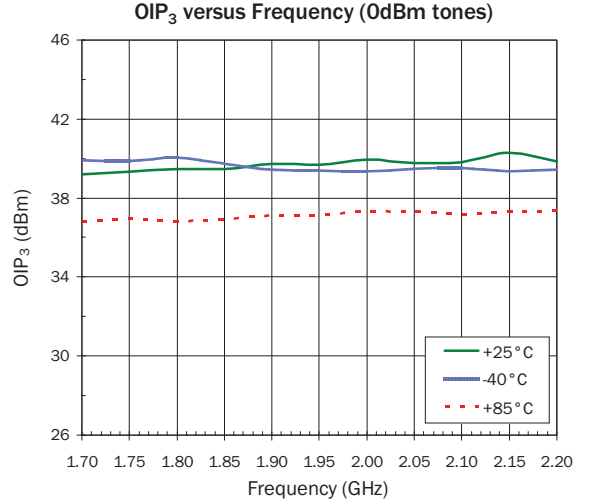
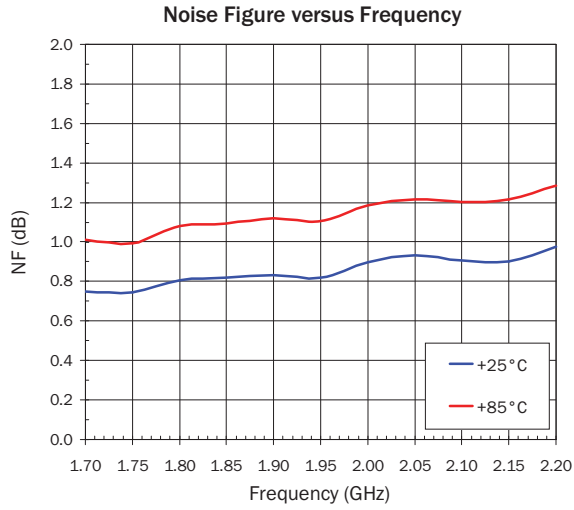

Typical RF Performance - 1900MHz Application Circuit with $V_D=3V$, $I_D=90mA$

S11 versus Frequency

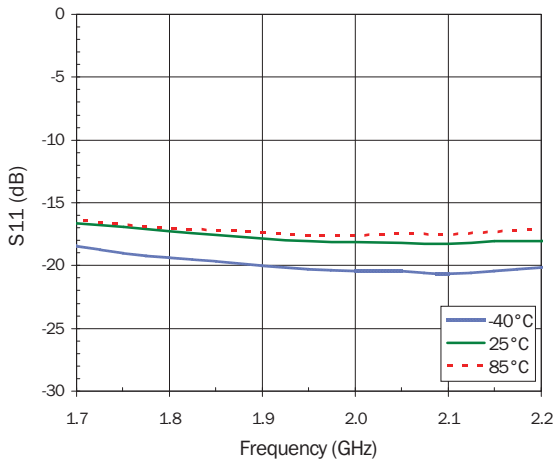

S21 versus Frequency

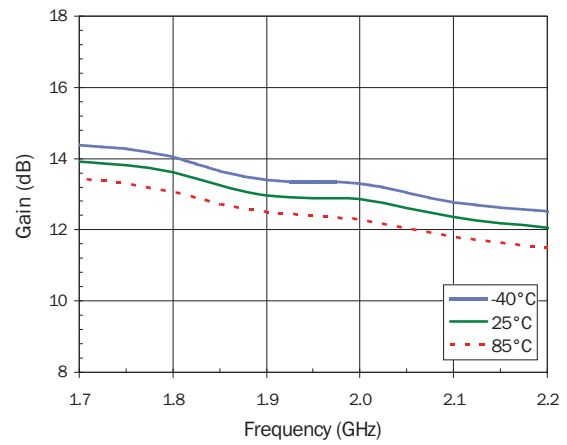

S12 versus Frequency

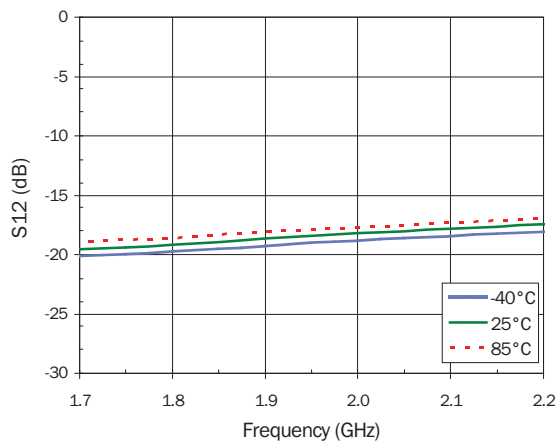

S22 versus Frequency

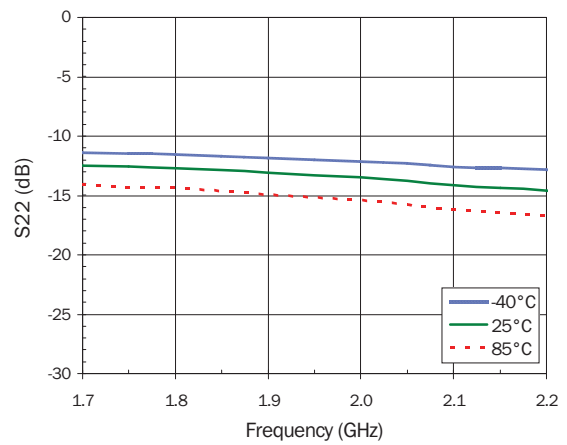

De-embedded Device S-parameters (Bias Tee Data)

G_{MAX} versus Frequency
(5V, 90mA)

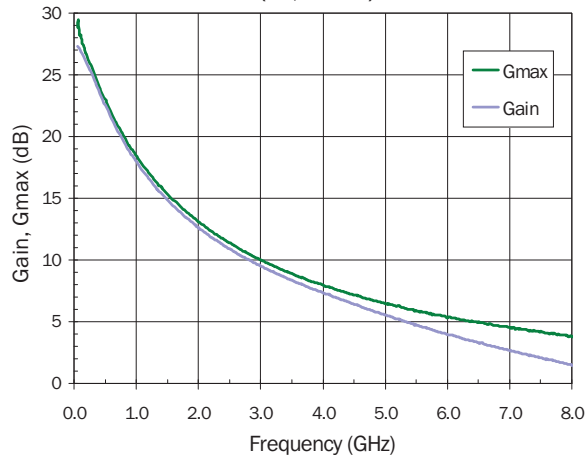

S₁₁ versus Frequency (5V, 90mA)

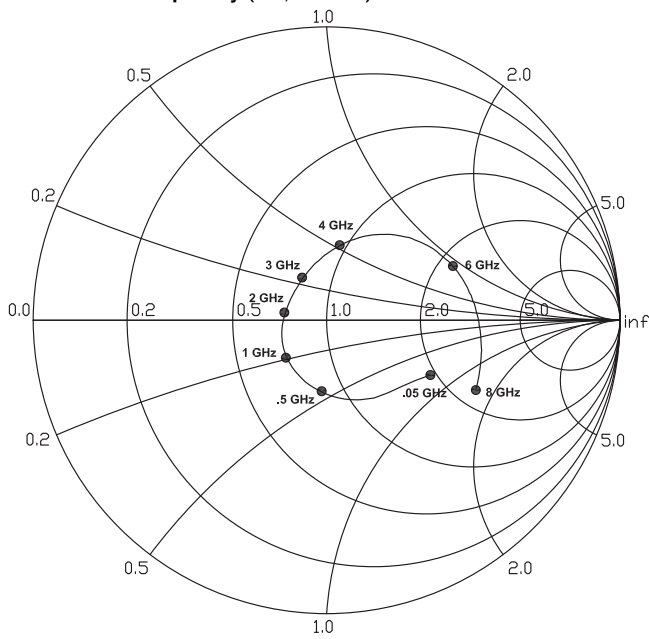

S₂₂ versus Frequency (5V, 90mA)

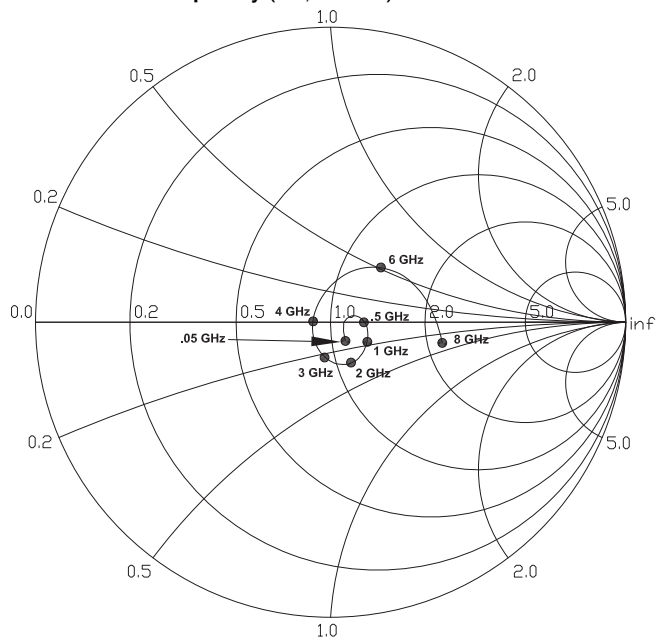

900MHz Evaluation Board Layout

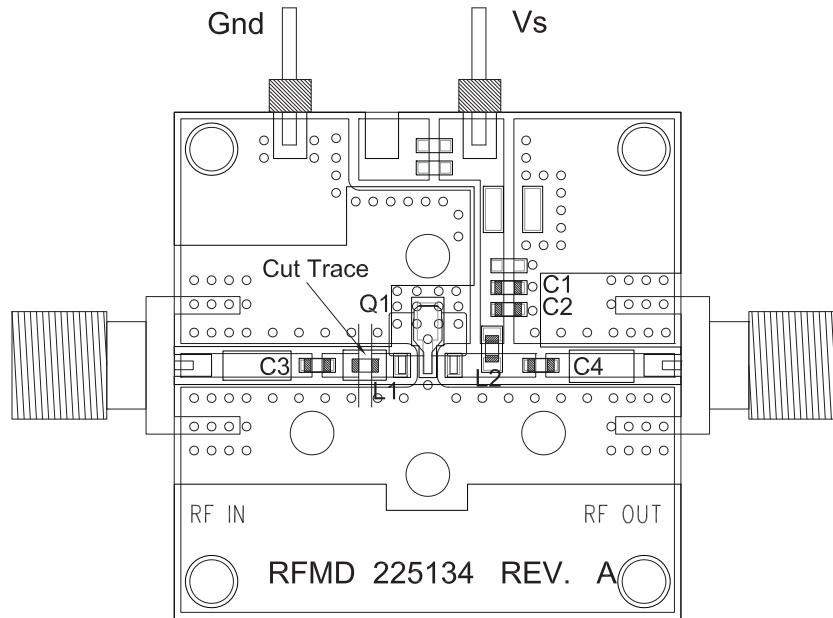

Bill of Materials (SPF5189Z, 900MHz)

C1	ECJ-1VB1C104, Panasonic, 0.1 uF
C2, C3, C4	ECJ-1VC1H101J, Panasonic, 100 pF
L1	LL1608-FSL1N5, Toko, 1.5 nH
L2	LL1608-FSR15J, Toko, 150 nH

900MHz Application Schematic

Note: Electrical lengths are determined from the center of shunt components and cuts on series transmission lines at 0.9GHz.

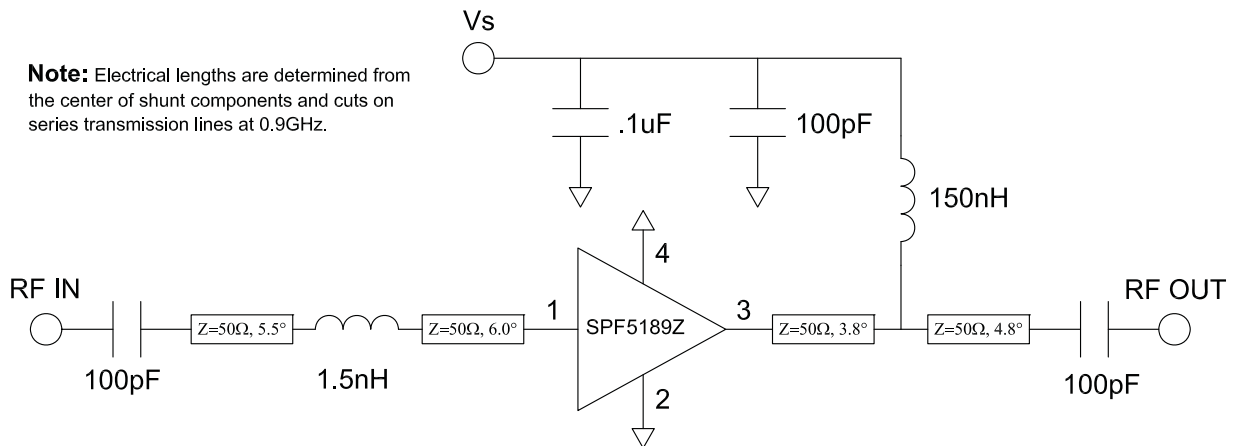

1900 MHz Evaluation Board Layout

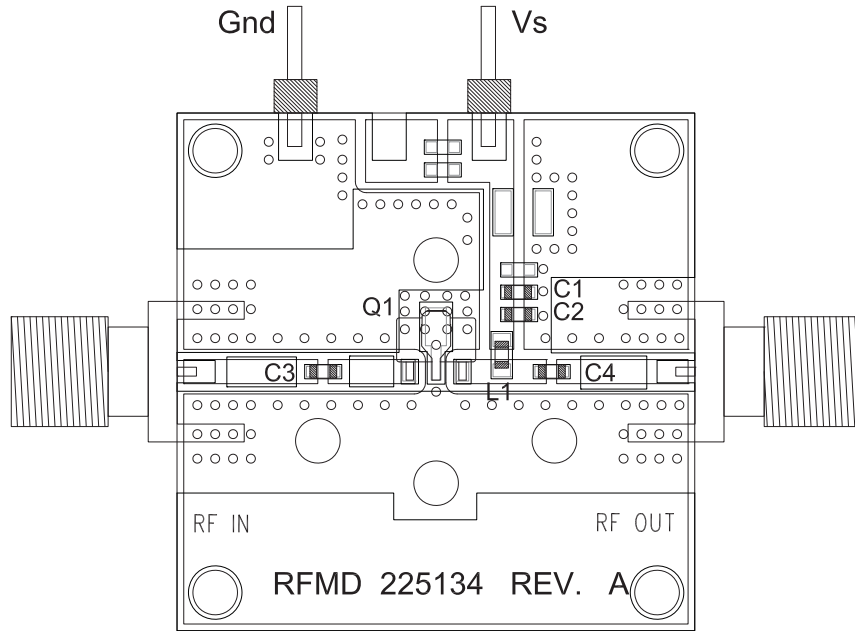

Bill of Materials (SPF5189Z, 1900MHz)

C1	ECJ-1VB1C104, Panasonic, 0.1 uF
C2, C4	ECJ-1VC1H101J, Panasonic, 100 pF
C3	ECJ-1VC1H100, Panasonic, 10 pF
L1	LL1608-FSL47N, Toko, 47 nH

1900 MHz Application Schematic

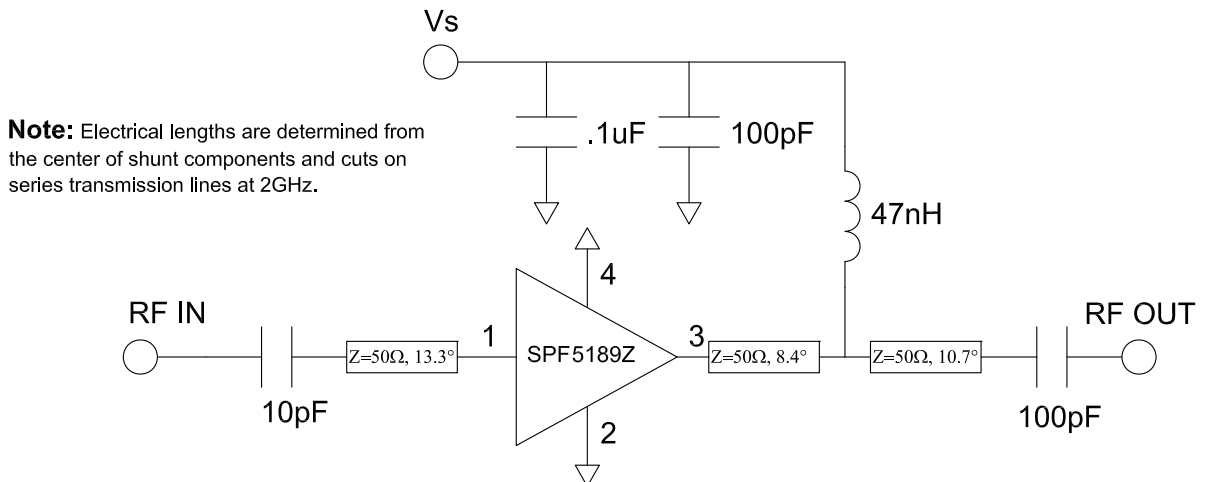

Pin Names and Description

Pin	Function	Description
1	RF IN	RF input pin. This pin requires the use of an external DC-blocking capacitor chosen for the frequency of operation.
2	GND	Connection to ground. Use via holes as close to the device ground leads as possible to reduce ground inductance and achieve optimum RF performance.
3	RF OUT/DC BIAS	RF output and bias pin. This pin requires the use of an external DC-blocking capacitor chosen for the frequency of operation.
4	GND	Connection to ground. Use via holes as close to the device ground leads as possible to reduce ground inductance and achieve optimum RF performance.

Part Identification

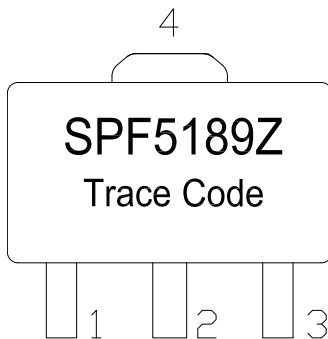

Suggested Pad Layout

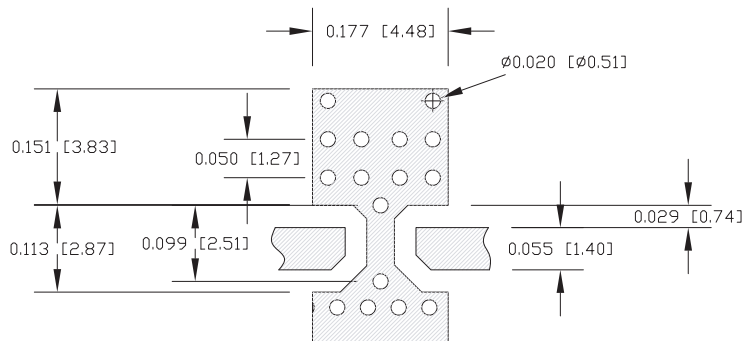

Package Drawing

Dimensions in inches (millimeters)

Refer to drawing posted at www.rfmd.com for tolerances.

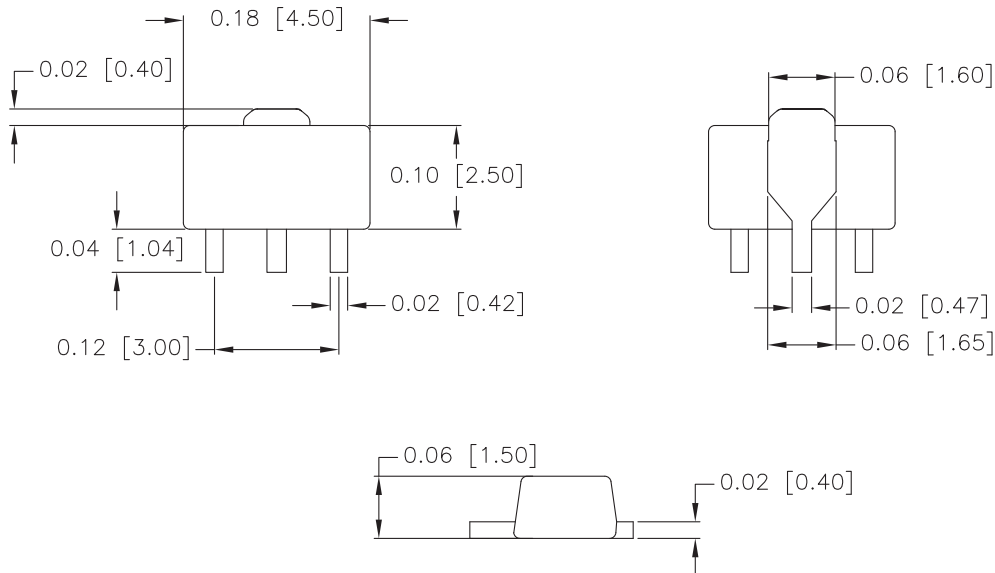

Ordering Information

Part Number	Description
SPF5189Z	7" Reel with 1000 pieces
SPF5189ZSQ	Sample Bag with 25 pieces
SPF5189ZSR	7" Reel with 100 pieces
SPF5189ZPCK1	800MHz to 1000MHz PCBA with 5-piece Sample Bag
SPF5189ZPCK2	1700MHz to 2200MHz PCBA with 5-piece Sample Bag

Компания «Океан Электроники» предлагает заключение долгосрочных отношений при поставках импортных электронных компонентов на взаимовыгодных условиях!

Наши преимущества:

- Поставка оригинальных импортных электронных компонентов напрямую с производств Америки, Европы и Азии, а так же с крупнейших складов мира;
- Широкая линейка поставок активных и пассивных импортных электронных компонентов (более 30 млн. наименований);
- Поставка сложных, дефицитных, либо снятых с производства позиций;
- Оперативные сроки поставки под заказ (от 5 рабочих дней);
- Экспресс доставка в любую точку России;
- Помощь Конструкторского Отдела и консультации квалифицированных инженеров;
- Техническая поддержка проекта, помощь в подборе аналогов, поставка прототипов;
- Поставка электронных компонентов под контролем ВП;
- Система менеджмента качества сертифицирована по Международному стандарту ISO 9001;
- При необходимости вся продукция военного и аэрокосмического назначения проходит испытания и сертификацию в лаборатории (по согласованию с заказчиком);
- Поставка специализированных компонентов военного и аэрокосмического уровня качества (Xilinx, Altera, Analog Devices, Intersil, Interpoint, Microsemi, Actel, Aeroflex, Peregrine, VPT, Syfer, Eurofarad, Texas Instruments, MS Kennedy, Miteq, Cobham, E2V, MA-COM, Hittite, Mini-Circuits, General Dynamics и др.);

Компания «Океан Электроники» является официальным дистрибьютором и эксклюзивным представителем в России одного из крупнейших производителей разъемов военного и аэрокосмического назначения «JONHON», а так же официальным дистрибьютором и эксклюзивным представителем в России производителя высокотехнологичных и надежных решений для передачи СВЧ сигналов «FORSTAR».



JONHON

«JONHON» (основан в 1970 г.)

Разъемы специального, военного и аэрокосмического назначения:

(Применяются в военной, авиационной, аэрокосмической, морской, железнодорожной, горно- и нефтедобывающей отраслях промышленности)

«FORSTAR» (основан в 1998 г.)

ВЧ соединители, коаксиальные кабели, кабельные сборки и микроволновые компоненты:

(Применяются в телекоммуникациях гражданского и специального назначения, в средствах связи, РЛС, а так же военной, авиационной и аэрокосмической отраслях промышленности).



Телефон: 8 (812) 309-75-97 (многоканальный)

Факс: 8 (812) 320-03-32

Электронная почта: ocean@oceanchips.ru

Web: <http://oceanchips.ru/>

Адрес: 198099, г. Санкт-Петербург, ул. Калинина, д. 2, корп. 4, лит. А