



Applications

- Distributed power architectures
- Telecommunications equipment
- LAN/WAN applications
- Data processing
- Industrial applications

Features

- RoHS lead free and lead-solder-exempted products are available
- Single board design
- Basic insulation
- 1500 VDC i/o electric strength test voltage
- Low profile SMT device: 8.5 mm
- Excellent co-planarity
- Low conducted and radiated EMI
- Output voltage sense function
- Output voltage adjust, positive or negative
- Output overcurrent protection
- Synchronization function
- Remote shutdown (primary referenced)
- Operating temperature up to 100 °C
- Meets EN55022 class A
- Safety-approved to IEC/EN 60950-1 and UL/CSA 60950-1 2nd Ed.

Description

The SFS Series of converters are low-profile, single-output DC-DC converters intended for SMT placement and reflow soldering. The product provides onboard conversion of standard telecom, datacom, and industrial input voltages to isolated low output voltages. Proprietary patented manufacturing process ensures optimal quality through full process automation. The converters are cost effective high performance alternatives to competing products on the market, both through hole and surface mount.

Model Selection

Model	Input Voltage VDC	Max. input current A	Output Voltage V	Output Current A	Output Ripple/Noise mV _{pp}	Typical Efficiency %
SFS13ZA- M6 ¹	36 – 72	0.8	1.5	13	60	80
SFS13ZB- M6 ¹	36 – 72	0.9	1.8	13	60	80
SFS13ZD- M6 ¹	36 – 72	1.2	2.5	13	80	81
SFS13ZE M6 ¹	36 – 72	1.5	3.3	13	80	86
SFS08ZG M6 ¹	36 – 72	1.4	5.0	8	80	86

¹ For products RoHS-compliant for all 6 substances, change the suffix **-M6** to **-M6G**.

Model numbers highlighted in yellow are not recommended for new designs.

Absolute Maximum Ratings

Stresses in excess of the absolute maximum ratings may cause performance degradation, adversely affect long term reliability and cause permanent damage to the converter. Specifications apply over specified input voltage, output load and temperature range, unless otherwise noted.

Parameter	Conditions/Description	Min	Max	Unit
Input voltage (V_i)	Continuous	36	72	VDC
Transient Input Voltage	Transient, 100 ms		100	VDC
Operating Case Temp. (T_C)	All operating conditions	-40	100	°C
Storage Temperature (T_S)		-55	125	°C
ON/OFF Control Voltage (V_{RC})	Referenced to $-V_i$	-5	12	V

Environmental and Mechanical

Specifications apply over specified input voltage, output load and temperature range, unless otherwise noted.

Parameter	Conditions/Description	Min	Nom	Max	Unit
Shock	IEC68-2-27			100	g_n
Sinusoidal Vibration	IEC68-2-6			10	g_n
Weight				25	g
Water Washing	Standard process	Yes			
MTBF	Per Bellcore TR-NWT-000332 (100% load @25 °C, GB)	1 127 000			h

Isolation

Parameter	Conditions/Description	Min	Nom	Max	Unit
Insulation Safety Rating	$V_i = V_{i\max}$	Basic			
Electric Strength Test Voltage			1500		VDC
Insulation Resistance		10			MΩ
Insulation Capacitance			1100		pF

Input Data

Specifications apply over specified input voltage, output load and temperature range, unless otherwise noted.

Parameter	Conditions/Description	Min	Nom	Max	Unit
Input Voltage (V_i)	Continuous	36	48	72	VDC
Input Current when Shutdown	$V_{i\text{nom}}$, Remote Control activated		2	5	mA
Input Current No Load	$V_{i\text{nom}}$, $I_o = 0$		20	50	mA
Turn-On Input Voltage	Ramping Up, $I_{o\max}$ (3.3V / 5V output versions only)	24 (34)	26 (35)	28 (36)	V
Turn-Off Input Voltage	Ramping Down, $I_{o\max}$ (3.3V / 5V output versions only)	25.5 (31.5)	27.5 (32.5)	29.5 (33.5)	V
Turn-On Time	To Output Regulation Band After Remote Control Rise Time		90 50 5	250	ms ms ms
Input Reflected Ripple Current	$V_{i\max}$, $I_{o\max}$			30	mA _{pp}
Input Capacitance				1.5	μF

Output Data

All specifications apply over input voltage, output load and temperature range, unless otherwise noted.

SFS13ZA : 1.5 V/13 A

Parameter		Conditions/Description	Min	Nom	Max	Unit
Output Voltage Setpoint Accuracy	V_o	$V_{i\text{ nom}}, I_o = 6.5 \text{ A}, 25 \text{ }^\circ\text{C}$	1.48	1.50	1.52	V
Output Current ¹	I_o	$V_{i\text{ min}} - V_{i\text{ max}}$	1	10	13	A
Line Regulation		$V_{i\text{ min}} - V_{i\text{ max}}, 50\% I_{o\text{ max}}$			25	mV
Load Regulation		$V_{i\text{ nom}}, I_{o\text{ min}} - I_{o\text{ max}}$		10	25	mV
Dynamic Regulation Peak Deviation Settling Time		50 – 100% $I_{o\text{ max}}$ load step change to 1% error band			± 250 500	mV µs
Output Voltage Ripple ²	V_R	$V_{i\text{ min}} - V_{i\text{ max}}, I_{o\text{ min}} - I_{o\text{ max}},$ 10 MHz bandwidth		60	100	mV _{pp}
Admissible Load Capacitance	$C_{o\text{ max}}$	$I_{o\text{ max}}, V_{i\text{ nom}}$			3 300	µF
Output Current Limit Threshold	I_{CL}	$V_o \leq 0.9 V_{o\text{ nom}}$	110		200	% $I_{o\text{ max}}$
Switching Frequency		$V_{i\text{ nom}}, I_{o\text{ max}}$		650		kHz
Temperature Coefficient	T_{CO}				0.06	% $V_o/^\circ\text{C}$
Trim Range		$V_{i\text{ min}} - V_{i\text{ max}}, I_{o\text{ min}} - I_{o\text{ max}}$	1.35		1.65	V

¹ Below $I_{o\text{ min}}$ the output maintains regulation but output ripple may increase

² Measured with a 1 µF ceramic capacitor across output pins, as shown on page 9

Typical Characteristic Curves

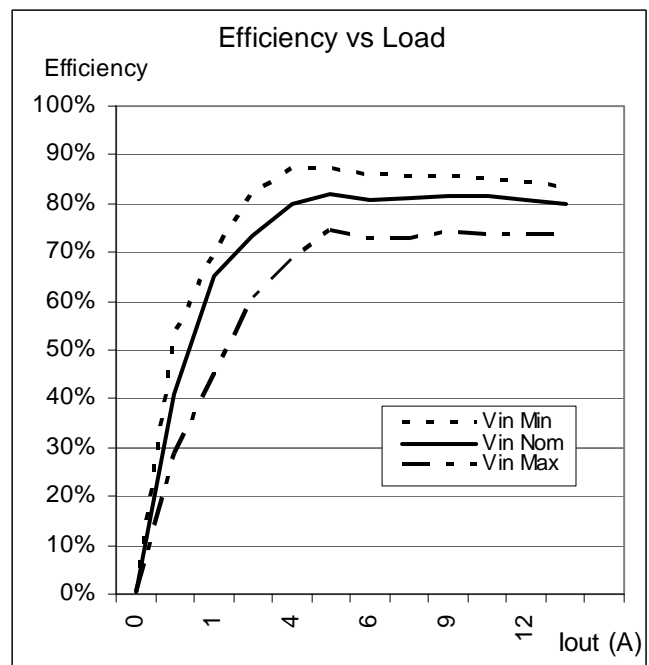
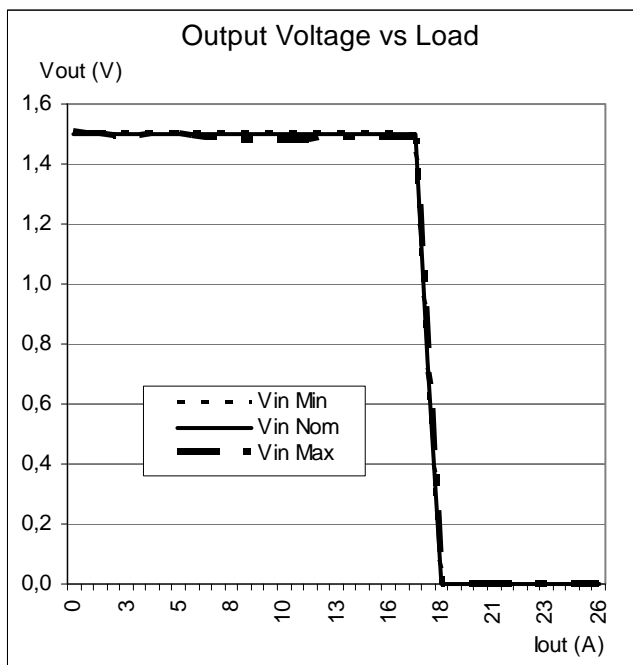

SFS13ZB : 1.8 V/13 A

Parameter		Conditions/Description	Min	Nom	Max	Unit
Output Voltage Setpoint	V_o	$V_{i\text{ nom}}, I_o = 6.5 \text{ A}, 25^\circ \text{C}$	1.78	1.80	1.82	V
Output Current ¹	I_o	$V_{i\text{ min}} - V_{i\text{ max}}$	1	10	13	A
Line Regulation		$V_{i\text{ min}} - V_{i\text{ max}}, 50\% I_{o\text{ max}}$			25	mV
Load Regulation		$V_{i\text{ nom}}, I_{o\text{ min}} - I_{o\text{ max}}$		10	25	mV
Dynamic Regulation Peak Deviation Settling Time		50 – 100% $I_{o\text{ max}}$ load step change to 1% error band			± 250 500	mV µs
Output Voltage Ripple ²	V_R	$V_{i\text{ min}} - V_{i\text{ max}}, I_{o\text{ min}} - I_{o\text{ max}},$ 10 MHz bandwidth		60	100	mV _{pp}
Admissible Load Capacitance	$C_{o\text{ max}}$	$I_{o\text{ max}}, V_{i\text{ nom}}$			3 300	µF
Output Current Limit Threshold	I_{CL}	$V_o \leq 0.9 V_{o\text{ nom}}$	110		200	% $I_{o\text{ max}}$
Switching Frequency		$V_{i\text{ nom}}, I_{o\text{ max}}$		650		kHz
Temperature Coefficient	T_{CO}				0.06	% $V_o/^\circ\text{C}$
Trim Range		$V_{i\text{ min}} - V_{i\text{ max}}, I_{o\text{ min}} - I_{o\text{ max}}$	1.62		1.98	V

¹ Below $I_{o\text{ min}}$ the output maintains regulation but output ripple may increase

² Measured with a 1 µF ceramic capacitor across output pins, as shown on page 9

Typical Characteristic Curves

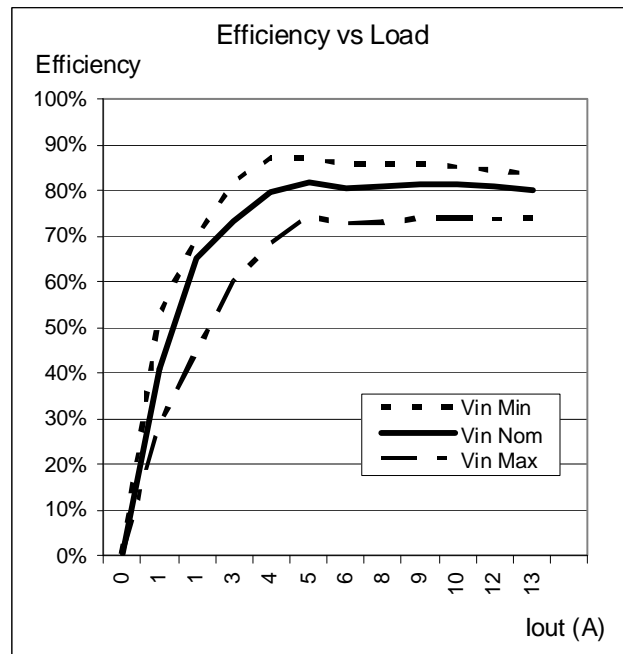
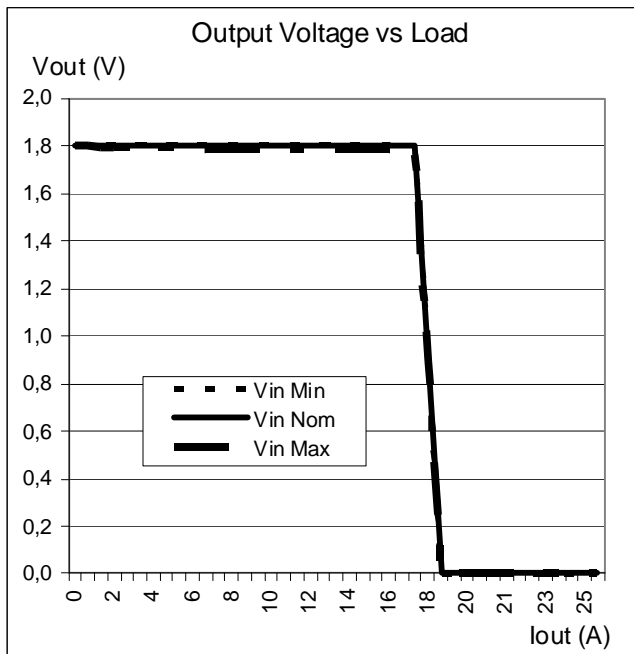

SFS13ZD : 2.5 V/13 A

Parameter		Conditions/Description	Min	Nom	Max	Unit
Output Voltage Setpoint Accuracy	V_o	$V_{i\ nom}, I_o = 6.5\ A, 25\ ^\circ C$	2.47	2.5	2.53	V
Output Current ¹	I_o	$V_{i\ min} - V_{i\ max}$	1	10	13	A
Line Regulation		$V_{i\ min} - V_{i\ max}, 50\% I_{o\ max}$			35	mV
Load Regulation		$V_{i\ nom}, I_{o\ min} - I_{o\ max}$		15	35	mV
Dynamic Regulation Peak Deviation		50 – 100% $I_{o\ max}$ load step change to 1% error band			250	± mV
Settling Time					500	µs
Output Voltage Ripple ²	V_R	$V_{i\ min} - V_{i\ max}, I_{o\ min} - I_{o\ max}, 10\ MHz\ bandwidth$		80	130	mV _{pp}
Admissible Load Capacitance	$C_{o\ max}$	$I_{o\ max}, V_{i\ nom}$			3 300	µF
Output Current Limit Threshold	I_{CL}	$V_o \leq 0.9 V_{o\ nom}$	110		200	% $I_{o\ max}$
Switching Frequency		$V_{i\ nom}, I_{o\ max}$		650		kHz
Temperature Coefficient	T_{CO}				0.06	% $V_o/^\circ C$
Trim Range		$V_{i\ min} - V_{i\ max}, I_{o\ min} - I_{o\ max}$	2.25		2.75	V

¹ Below $I_{o\ min}$ the output maintains regulation but output ripple may increase

² Measured with a 1 µF ceramic capacitor across output pins, as shown on page 9.

Typical Characteristic Curves

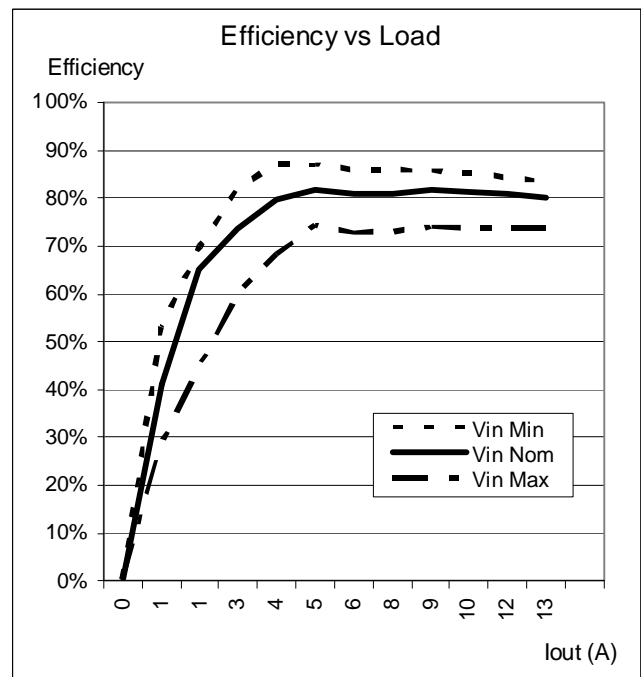
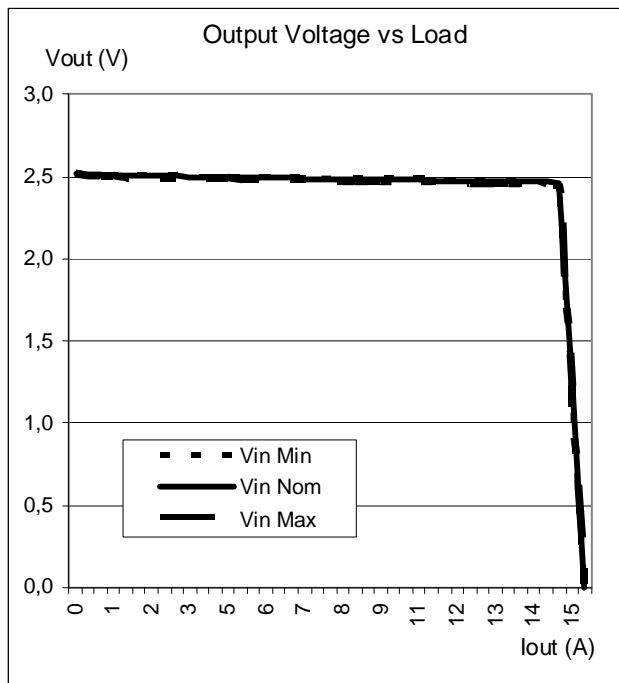

SFS13ZE : 3.3 V/13 A

Parameter		Conditions/Description	Min	Nom	Max	Unit
Output Voltage Setpoint Accuracy	V_o	$V_{i\text{ nom}}, I_o = 6.5 \text{ A}, 25^\circ\text{C}$	3.26	3.3	3.34	V
Output Current ¹	I_o	$V_{i\text{ min}} - V_{i\text{ max}}$	1	10	13	A
Line Regulation		$V_{i\text{ min}} - V_{i\text{ max}}, 50\% I_{o\text{ max}}$			45	mV
Load Regulation		$V_{i\text{ nom}}, I_{o\text{ min}} - I_{o\text{ max}}$		20	45	mV
Dynamic Regulation Peak Deviation		50 – 100% $I_{o\text{ max}}$ load step change			±350	mV
Settling Time		to 1% error band			500	µs
Output Voltage Ripple ²	V_R	$V_{i\text{ min}} - V_{i\text{ max}}, I_{o\text{ min}} - I_{o\text{ max}}, 10 \text{ MHz bandwidth}$		80	130	mV _{pp}
Admissible Load Capacitance	$C_{o\text{ max}}$	$I_{o\text{ max}}, V_{i\text{ nom}}$			3 300	µF
Output Current Limit Threshold	I_{CL}	$V_o \leq 0.9 V_{o\text{ nom}}$	110		200	% $I_{o\text{ max}}$
Switching Frequency		$V_{i\text{ nom}}, I_{o\text{ max}}$		650		kHz
Temperature Coefficient	T_{CO}				0.06	% $V_o/^\circ\text{C}$
Trim Range		$V_{i\text{ min}} - V_{i\text{ max}}, I_{o\text{ min}} - I_{o\text{ max}}$	3.0		3.6	V

¹ Below $I_{o\text{ min}}$ the output maintains regulation but output ripple may increase

² Measured with a 1 µF ceramic capacitor across output pins, as shown on page 9

Typical Characteristic Curves

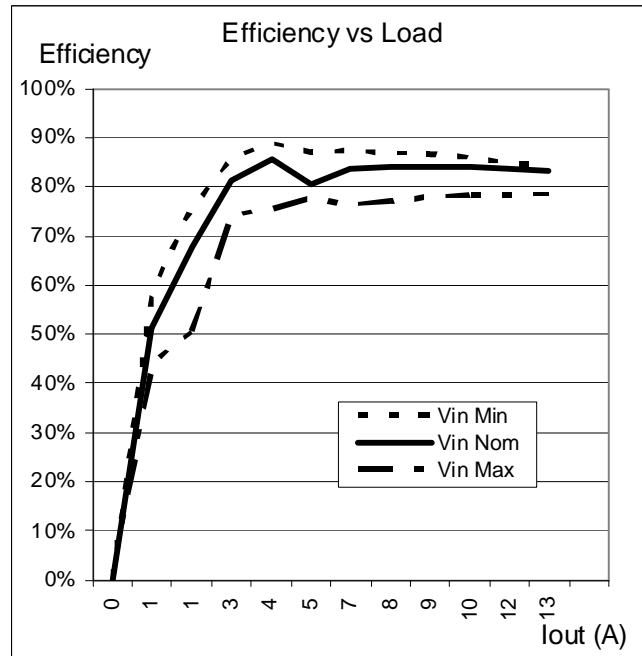
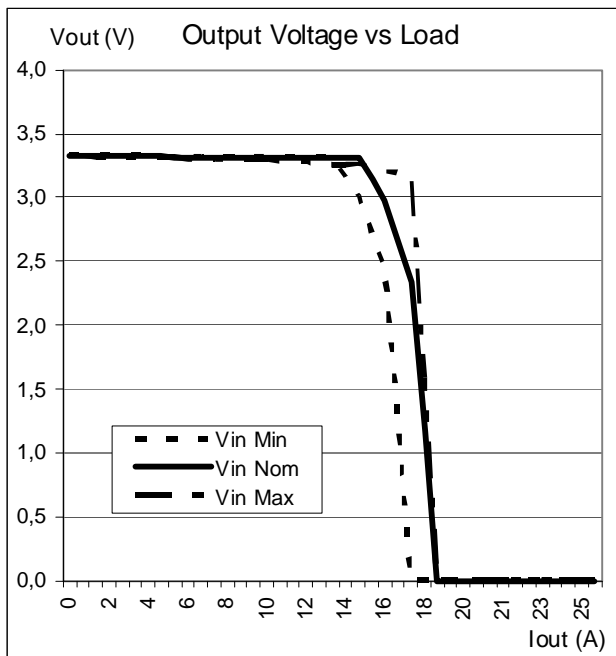

SFS08ZG : 5.0 V/8 A

Parameter		Conditions/Description	Min	Nom	Max	Unit
Output Voltage Setpoint Accuracy	V_o	$V_{i\text{ nom}}, I_o = 6.5\text{ A}, 25\text{ }^\circ\text{C}$	4.94	5.0	5.06	V
Output Current ¹	I_o	$V_{i\text{ min}} - V_{i\text{ max}}$	0.8	6	8	A
Line Regulation		$V_{i\text{ min}} - V_{i\text{ max}}, 50\% I_{o\text{ max}}$			65	mV
Load Regulation		$V_{i\text{ nom}}, I_{o\text{ min}} - I_{o\text{ max}}$		30	65	mV
Dynamic Regulation Peak Deviation		50 – 100% $I_{o\text{ max}}$ load step change			± 350	mV
Settling Time		to 1% error band			500	µs
Output Voltage Ripple ²	V_R	$V_{i\text{ min}} - V_{i\text{ max}}, I_{o\text{ min}} - I_{o\text{ max}}, 10\text{ MHz bandwidth}$		80	130	mV _{pp}
Admissible Load Capacitance	$C_{o\text{ max}}$	$I_{o\text{ max}}, V_{i\text{ nom}}$			3 300	µF
Output Current Limit Threshold	I_{CL}	$V_o \leq 0.9 V_{o\text{ nom}}$	110		200	% $I_{o\text{ max}}$
Switching Frequency		$V_{i\text{ nom}}, I_{o\text{ max}}$		650		kHz
Temperature Coefficient	T_{CO}				0.06	% $V_o/^\circ\text{C}$
Trim Range		$V_{i\text{ min}} - V_{i\text{ max}}, I_{o\text{ min}} - I_{o\text{ max}}$	4.5		5.5	V

¹ Below $I_{o\text{ min}}$ the output maintains regulation, but output ripple may increase

² Measured with a 1 µF ceramic capacitor across output pins, as shown on page 9

Typical Characteristic Curves

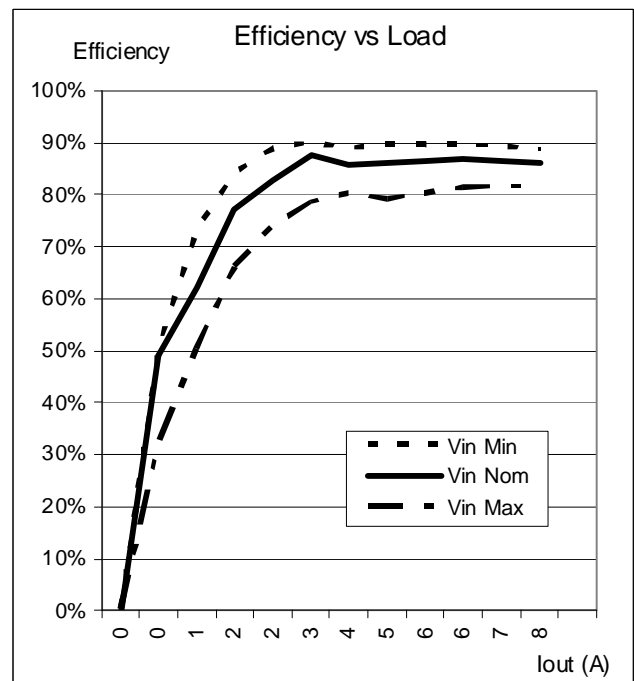
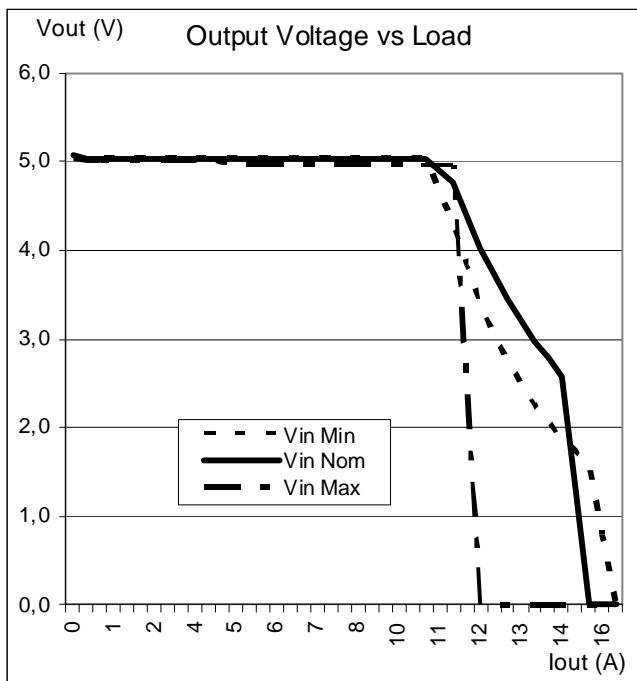

Auxiliary Functions Data

All specifications apply over input voltage, output load and temperature range, unless otherwise noted.

Parameter	Conditions/Description	Min	Nom	Max	Units
Shutdown Control: Converter OFF Converter ON Sink Current	Shutdown pin is pulled low Voltage source or open circuit $V_i = V_{i\text{nom}}$	-1.0 3.5	0.3	1.0 6	V V mA
Synchronization: Frequency Range	TTL compatible square wave on sync pin. Referenced to $-V_i$	700		800	kHz
Voltage Sense Range	Available compensation		±10		%

Temperature Derating Curves

The derating curves below give an indication of the output power achievable with and without forced-air cooling. However in the final application, in order to ensure the reliability of the unit, care must be taken to ensure the maximum case temperature is not exceeded under any conditions.

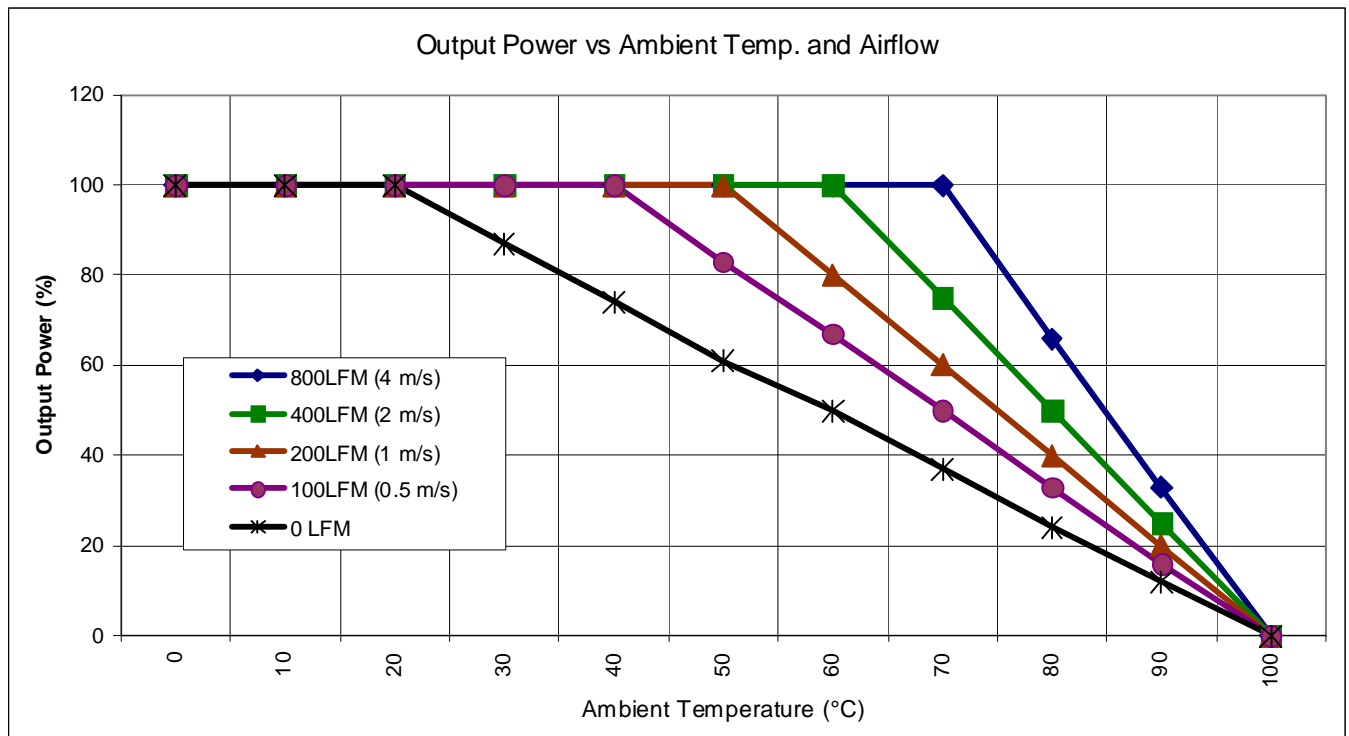

Note: For continuous operation above 60 V input, the available output power is further derated linearly up to 50% at 75 V input. This additional derating is due to a predictable drop in efficiency at high input voltage.

Application and Auxiliary Functions

This series of converters does not require any external components for proper operation. However, if the input voltage line contains significant inductance, a capacitor across the input terminals may be required to stabilize the input voltage. A minimum of 1 μF , quality electrolytic or ceramic capacitor is recommended for this purpose.

For output decoupling it is recommended to connect a 1 μF ceramic capacitor directly across the output pins of the converter (illustrated as follows).

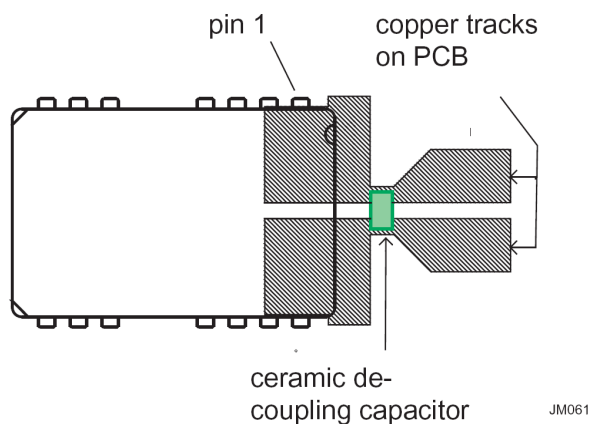

Shutdown

The remote control pin functions as a normal soft shutdown. It is referenced to the $-V_i$ pin. With positive logic, when the remote control pin is pulled low, the output is turned off, and the unit goes into a very low input power mode.

An open-collector switch is recommended to control the voltage between the remote control pin and the $-V_i$ pin. The remote control pin is pulled up internally, so no external voltage source is required. The user should not connect a resistor between the remote control pin and the $+V_i$ pin.

The user must take care to ensure that the pin reference for the control is connected close to the $-V_i$ pin. The control signal must not be referenced ahead of EMI filtering, or remotely from the unit. If the remote control pin is not used, it can be left open-circuit.

Thermal Considerations

The converter is designed for natural or forced convection cooling. The output power of the converter is limited by the maximum case temperature (T_C). To ensure reliable long term operation of the converters, and to comply with safety agency requirements, Power-One limits maximum allowable case temperature (T_C) to 100 $^{\circ}\text{C}$; see *Mechanical Data*.

Output Current Limitation

When the output is loaded above the maximum output current rating, the voltage will start to reduce to maintain the output power to a safe level. In a condition of high overload or short-circuit, where the output voltage is pulled below approximately 30% of $V_{O\text{ nom}}$, the converter will enter a hiccup mode of operation. Under this condition, the converter will attempt to restart, approximately every 20 ms, until the overload has cleared.

Sense Lines

The voltage sense feature compensates for voltage drops that may occur at the point of load due to PCB tracks or other losses. Pin 3 and pin 16 are used to sense the output voltage at point of load.

If the sense feature is not used, it is necessary to connect pin 3 to pins 1 + 2 and pin 16 to pins 17 + 18.

Note: When the output voltage is sensed remotely at the load, the output power from the converter must not exceed its maximum rating. This is determined by measuring the voltage on the output pins, and multiplying it by the output current.

Output Voltage Adjust

This feature allows the user to adjust the output voltage. Output voltage can be adjusted using an external resistor. To increase V_o a resistor should be connected between pin 15 and pins 17 & 18. To decrease V_o a resistor should be connected between pin 15 and pins 1 & 2.

To increase V_o :

$$R_{\text{ext}} = (A - (D \times V_o)) / (V_o - V_{o \text{ nom}}) \quad [\Omega]$$

To reduce V_o :

$$R_{\text{ext}} = ((B \times V_o) - C) / (V_{o \text{ nom}} - V_o) \quad [\Omega]$$

Model	A	B	C	D
SFS13ZA	1945	1470	1944	470
SFS13ZB	2590	1730	2560	750
SFS13ZD	5010	2516	5010	1500
SFS13ZE	7010	3161	7010	1500
SFS08ZG	11260	4532	11240	1500

Note: When the output voltage is trimmed up, the output power from the converter must not exceed its maximum rating. This is determined by measuring the voltage on the output pins, and multiplying it by the output current.

Parallel Operation

Paralleling of two converters is not possible.

Synchronization

It is possible to synchronize the switching frequency of one or more converters to an external symmetrical clock signal. Consult factory for full application details, if this option is required.

Safety

These converters are tested with 1500 VDC from input to output. The input-to-output resistance is greater than 10 M Ω . These converters are provided with Basic Insulation between input and output. Nevertheless, if the system using the converter needs to receive safety agency approval, certain rules must be followed in the design of the system. In particular, all of the creepage and clearance requirements of the end-use system must be observed.

In order to consider the output of the converter as SELV (Safety Extra Low Voltage) or TNV-1, according to IEC/EN 60950-1 and UL/CSA 60950-1, the following requirements must be met in the system design:

- Fuse: As the converter has no internal fuse, an external fuse must be provided to protect the system from catastrophic failure. We recommend a fuse with a rating not greater than 2.0 A. The user can select a fuse with lower rating based upon the maximum inrush transient and the maximum input current at the minimum input voltage. Both input traces and the chassis ground trace (if applicable) must be capable of conducting a current of 1.5 times the value of the fuse without opening. The fuse must not be placed in the grounded input line.
- If the voltage source feeding the converter is SELV, TNV-1, or TNV-2, the output of the converter is considered SELV and may be grounded or ungrounded.
- The circuitry of the converter may generate transients, which exceed the input voltage. Even if the input voltage is SELV (<60 V), the components on the primary side of the converter may have to be considered as hazardous. A safety interlock may be needed to prevent the user from accessing the converter while operational.

EMC Specifications

Conducted Noise

The converters meet the requirements of EN 55022 Class A (conducted noise on the input terminals) without external components; see below.

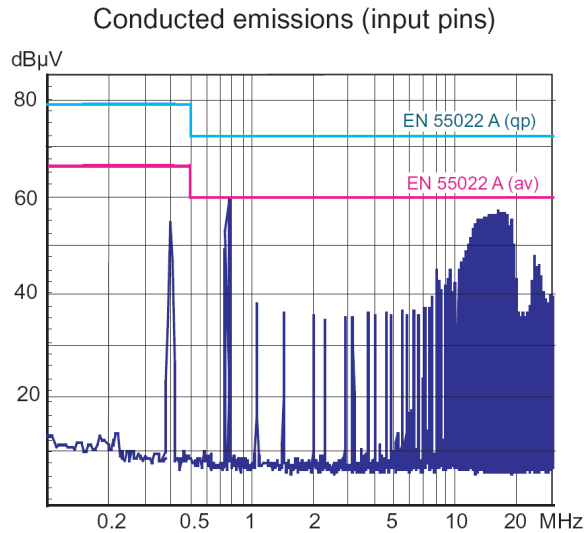

To meet level B, it is necessary to fit a 5 µF ceramic capacitor across the input terminals.

Electromagnetic Susceptibility

Standard	Applied Stress	Class Level	Performance Criterion *
Electrostatic Discharge EN61000-4-2	2 kV to pins	1	B
Electromagnetic Field EN61000-4-3	3 V/m	2	A
Electrical Fast Transient EN61000-4-4	2000 V _p to input	3	B
Conducted Disturbances EN61000-4-6	3 VAC to input	2	B

* **A** denotes normal operation, no deviation from specification. **B** denotes temporary deviation from specification possible.

Mechanical Data

Dimensions in mm [inches]

Note: Pickup point not central.

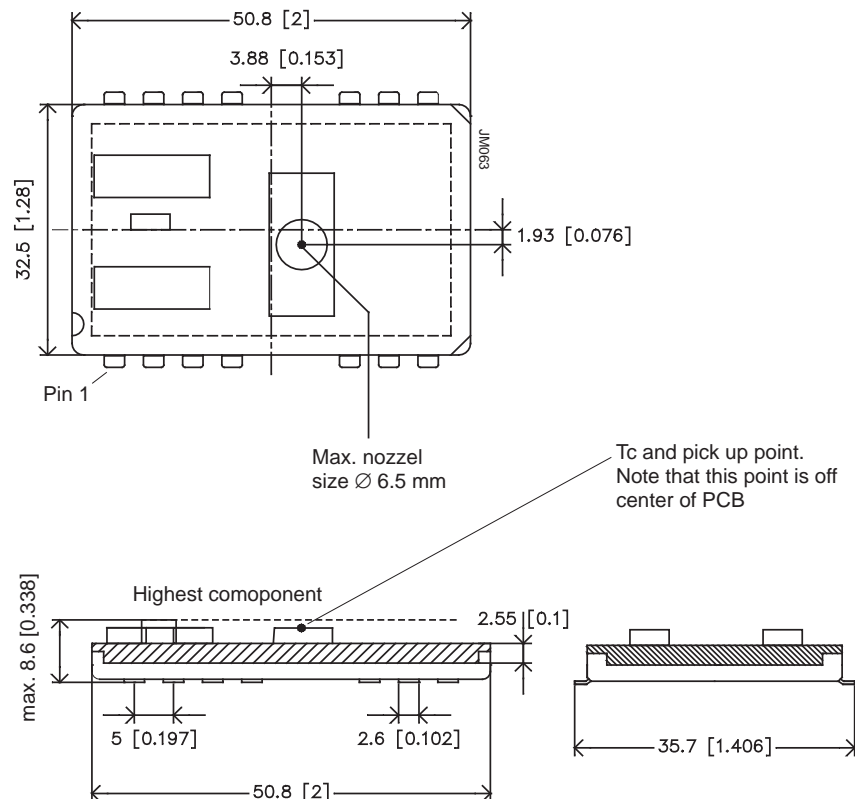

Surface Mount Assembly

Soldering

The following soldering instructions must be observed to prevent failure or significant degradation of the converter performance. Power-One will not honor any warranty claims arising from failure to observe these instructions.

The lead-frame is constructed for a high temperature glass filled, UL94 V-0 flame retardant, dually ortho-phthalate molding compound commonly used for packaging of electronics components. It has passed NASA outgassing tests, and is certified to MIL-M-14. The coefficient of thermal expansion is equivalent to FR4.

The gull wing leads are formed to ensure optimal solder joint strength and structure. Furthermore they facilitate visual inspection (manual or automatic). The leads are formed from a 97% Cu alloy plated with Ni and matte Sn. This material is commonly used

in the manufacture of integrated circuits. It has good corrosion resistance and exhibits the nobility inherent to all high copper alloys. Unlike brasses, this material is essentially immune to stress corrosion cracking. It also exhibits excellent solderability. It is readily wetted by solders and performs well in standard solderability tests. (Dip of Class II or better).

The product is manufactured with a patented process, which is fully automated and 'in-line'. This ensures that there is no contamination or mechanical stress on the lead-frame so that the co-planarity and solderability are maintained.

The product is shipped in JEDEC trays to ensure preservation of the co-planarity and enable fully automated assembly in the final application. Mind the marking for pin 1!

These products are approved for forced convection reflow soldering only. Products RoHS-compliant for all 6 substances (model designation ending with G) allow for a solder profile with higher temperatures; see tables below.

Recommended Reflow Profile (measured at the leads of the converter)

Product	Pre-heat ramp			Pre-heat soaking			Ramp to reflow	Reflow				Cooling
	From °C	To °C	Rate °C/s	From °C	To °C	Time s	Rate °C	Time above liquidus s	Peak temp. °C	Time within ±5 °C of peak temp s	Time to peak s	Rate °C/s
-M6 (Sn-Pb eutectic)	25	150	2	150	183	90 - 120	2	45	220 ±5	10	180	3
-M6G (lead-free)	25	180	2	180	217	90 - 120	2	45	240 ±5	10	210	3

Worst Case Reflow Parameters Following J-STD-020D (measured in the center, on top side of the converter)

Product	Pre-heat ramp			Pre-heat soaking			Ramp to reflow	Reflow				Cooling
	From °C	To °C	Rate °C/s	From °C	To °C	Max. time s	Rate °C	Max. time above liquidus s	Max. peak temp. °C	Max. time within ±5 °C of peak temp. s	Max. time to peak s	Rate °C/s
-M6 (Sn-Pb eutectic)	25	150	3	100	150	120	3	45	230	10	360	6
-M6G (lead-free)	25	180	3	150	200	120	3	45	260	10	480	6

Pick & Place Assembly

The product is designed to have a large flat area in the center of the top surface to serve as a pick up point for automated vacuum pick and place equipment. The 'open board' construction of the unit ensures that weight is kept to a minimum. However due to the relatively large size of the component, a large nozzle (>8 mm, depending on vacuum pressure) is recommended for picking and placing.

The product may also be automatically handled using 'odd-form' placement equipment, with mechanical grippers. For this type of equipment the end edges of the device, which have no leads and also feature the greatest dimensional accuracy, should be used as pick-up points.

Recommended Solder Lands

Note: Pickup point not central.

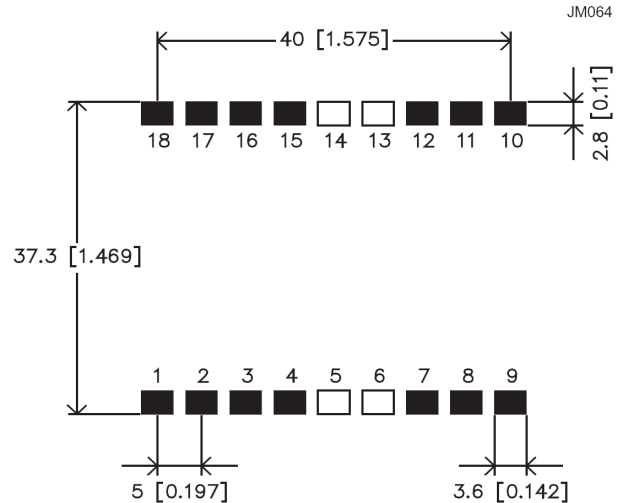

Packaging: JEDEC Tray

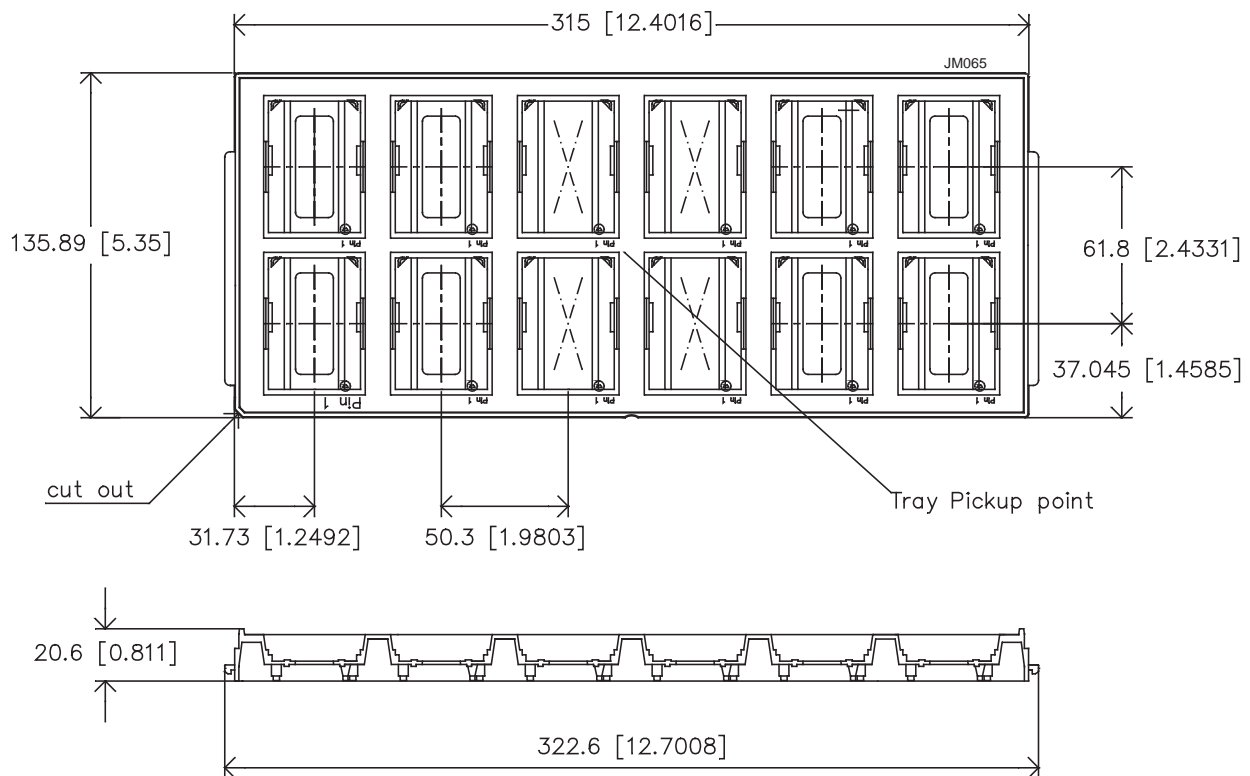

Pin Allocation

Pin	Designation	Function	Reference
1	+V _O	Positive output voltage	Secondary
2	+V _O	Positive output voltage	Secondary
3	+V _{SENSE}	Positive output voltage sense	Secondary
4	NC	Not connected	Secondary
5	No pin	No pin	
6	No pin	No pin	
7	NC	Not connected	Primary
8	Sync	Synchronization input	Primary
9	+V _I	Positive input voltage	Primary
10	-V _I	Negative input voltage	Primary
11	Shutdown	Shutdown control	Primary
12	NC	Not connected	Primary
13	No pin	No pin	
14	No pin	No pin	
15	Trim	Output voltage adjust	Secondary
16	-V _{SENSE}	Output voltage sense return	Secondary
17	-V _O	Output voltage return	Secondary
18	-V _O	Output voltage return	Secondary

NUCLEAR AND MEDICAL APPLICATIONS - Power-One products are not designed, intended for use in, or authorized for use as critical components in life support systems, equipment used in hazardous environments, or nuclear control systems without the express written consent of the respective divisional president of Power-One, Inc.

TECHNICAL REVISIONS - The appearance of products, including safety agency certifications pictured on labels, may change depending on the date manufactured. Specifications are subject to change without notice.

Компания «Океан Электроники» предлагает заключение долгосрочных отношений при поставках импортных электронных компонентов на взаимовыгодных условиях!

Наши преимущества:

- Поставка оригинальных импортных электронных компонентов напрямую с производств Америки, Европы и Азии, а так же с крупнейших складов мира;
- Широкая линейка поставок активных и пассивных импортных электронных компонентов (более 30 млн. наименований);
- Поставка сложных, дефицитных, либо снятых с производства позиций;
- Оперативные сроки поставки под заказ (от 5 рабочих дней);
- Экспресс доставка в любую точку России;
- Помощь Конструкторского Отдела и консультации квалифицированных инженеров;
- Техническая поддержка проекта, помощь в подборе аналогов, поставка прототипов;
- Поставка электронных компонентов под контролем ВП;
- Система менеджмента качества сертифицирована по Международному стандарту ISO 9001;
- При необходимости вся продукция военного и аэрокосмического назначения проходит испытания и сертификацию в лаборатории (по согласованию с заказчиком);
- Поставка специализированных компонентов военного и аэрокосмического уровня качества (Xilinx, Altera, Analog Devices, Intersil, Interpoint, Microsemi, Actel, Aeroflex, Peregrine, VPT, Syfer, Eurofarad, Texas Instruments, MS Kennedy, Miteq, Cobham, E2V, MA-COM, Hittite, Mini-Circuits, General Dynamics и др.);

Компания «Океан Электроники» является официальным дистрибьютором и эксклюзивным представителем в России одного из крупнейших производителей разъемов военного и аэрокосмического назначения «JONHON», а так же официальным дистрибьютором и эксклюзивным представителем в России производителя высокотехнологичных и надежных решений для передачи СВЧ сигналов «FORSTAR».



JONHON

«JONHON» (основан в 1970 г.)

Разъемы специального, военного и аэрокосмического назначения:

(Применяются в военной, авиационной, аэрокосмической, морской, железнодорожной, горно- и нефтедобывающей отраслях промышленности)

«FORSTAR» (основан в 1998 г.)

ВЧ соединители, коаксиальные кабели, кабельные сборки и микроволновые компоненты:

(Применяются в телекоммуникациях гражданского и специального назначения, в средствах связи, РЛС, а так же военной, авиационной и аэрокосмической отраслях промышленности).



Телефон: 8 (812) 309-75-97 (многоканальный)

Факс: 8 (812) 320-03-32

Электронная почта: ocean@oceanchips.ru

Web: <http://oceanchips.ru/>

Адрес: 198099, г. Санкт-Петербург, ул. Калинина, д. 2, корп. 4, лит. А