

## RL78/G1A

R01DS0151EJ0210

## RENESAS MCU

Rev.2.10

Nov 30, 2016

 Combines Multi-channel 12-Bit A/D Converter, True Low Power Platform (as low as 66  $\mu\text{A}/\text{MHz}$ , and 0.57  $\mu\text{A}$  for RTC + LVD), 1.6 V to 3.6 V operation, 16 to 64 Kbyte Flash, 41 DMIPS at 32 MHz

## 1. OUTLINE

## 1.1 Features

**Ultra-Low Power Technology**

- 1.6 V to 3.6 V operation from a single supply
- Stop (RAM retained): 0.23  $\mu\text{A}$ , (LVD enabled): 0.31  $\mu\text{A}$
- Halt (RTC + LVD): 0.57  $\mu\text{A}$
- Snooze: 0.7 mA (UART), 0.6 mA (ADC)
- Operating: 66  $\mu\text{A}/\text{MHz}$

**16-bit RL78 CPU Core**

- Delivers 41 DMIPS at maximum operating frequency of 32 MHz
- Instruction Execution: 86% of instructions can be executed in 1 to 2 clock cycles
- CISC Architecture (Harvard) with 3-stage pipeline
- Multiply Signed & Unsigned: 16 x 16 to 32-bit result in 1 clock cycle
- MAC: 16 x 16 to 32-bit result in 2 clock cycles
- 16-bit barrel shifter for shift & rotate in 1 clock cycle
- 1-wire on-chip debug function

**Code Flash Memory**

- Density: 16 KB to 64 KB
- Block size: 1 KB
- On-chip single voltage flash memory with protection from block erase/writing
- Self-programming with secure boot swap function and flash shield window function

**Data Flash Memory**

- Data Flash with background operation
- Data flash size: 4 KB
- Erase Cycles: 1 Million (typ.)
- Erase/programming voltage: 1.8 V to 3.6 V

**RAM**

- 2 KB to 4 KB size options
- Supports operands or instructions
- Back-up retention in all modes

**High-speed On-chip Oscillator**

- 32 MHz with +/- 1% accuracy over voltage (1.8 V to 3.6 V) and temperature (-20  $^{\circ}\text{C}$  to +85  $^{\circ}\text{C}$ )
- Pre-configured settings: 32 MHz, 24 MHz, 16 MHz, 12 MHz, 8 MHz, 6 MHz, 4 MHz, 3 MHz, 2 MHz, and 1 MHz

**Reset and Supply Management**

- Power-on reset (POR) monitor/generator
- Low voltage detection (LVD) with 12 setting options (Interrupt and/or reset function)

**Data Memory Access (DMA) Controller**

- Up to 2 fully programmable channels
- Transfer unit: 8- or 16-bit

**Multiple Communication Interfaces**

- Up to 6 x I<sup>2</sup>C master
- Up to 1 x I<sup>2</sup>C multi-master
- Up to 6 x CSI/SPI (7-, 8-bit)
- Up to 3 x UART (7-, 8-, 9-bit)
- Up to 1 x LIN

**Extended-Function Timers**

- Multi-function 16-bit timers: Up to 8 channels
- Real-time clock (RTC): 1 channel (full calendar and alarm function with watch correction function)
- Interval Timer: 12-bit, 1 channel
- 15 kHz watchdog timer: 1 channel (window function)

**Rich Analog**

- ADC: Up to 28 channels, 12-bit resolution, 3.375  $\mu\text{s}$  conversion time
- Supports 1.6 V
- Internal voltage reference (1.45 V)
- On-chip temperature sensor

**Safety Features (IEC or UL 60730 compliance)**

- Flash memory CRC calculation
- RAM parity error check
- RAM write protection
- SFR write protection
- Illegal memory access detection
- Clock stop/ frequency detection
- ADC self-test

**General Purpose I/O**

- 3.6 V tolerant, high-current (up to 20 mA per pin)
- Open-Drain, Internal Pull-up support

**Operating Ambient Temperature**

- Standard: -40  $^{\circ}\text{C}$  to +85  $^{\circ}\text{C}$
- Extended: -40  $^{\circ}\text{C}$  to +105  $^{\circ}\text{C}$

**Package Type and Pin Count**

From 3 mm x 3 mm to 10 mm x 10 mm  
 QFP: 48, 64  
 QFN: 32, 48  
 LGA: 25  
 BGA: 64

## ○ ROM, RAM capacities

Flash ROM	Data flash	RAM	RL78/G1A			
			25 pins	32 pins	48 pins	64 pins
64 KB	4 KB	4 KB <b>Note</b>	R5F10E8E	R5F10EBE	R5F10EGE	R5F10ELE
48 KB	4 KB	3 KB	R5F10E8D	R5F10EBD	R5F10EGD	R5F10ELD
32 KB	4 KB	2 KB	R5F10E8C	R5F10EBC	R5F10EGC	R5F10ELC
16 KB	4 KB	2 KB	R5F10E8A	R5F10EBA	R5F10EGA	–

**Note** This is about 3 KB when the self-programming function and data flash function are used. (For details, see **3. ELECTRICAL SPECIFICATIONS (G: INDUSTRIAL APPLICATIONS TA = –40 to +105°C)**)

1.2 List of Part Numbers

Figure 1-1. Part Number, Memory Size, and Package of RL78/G1A

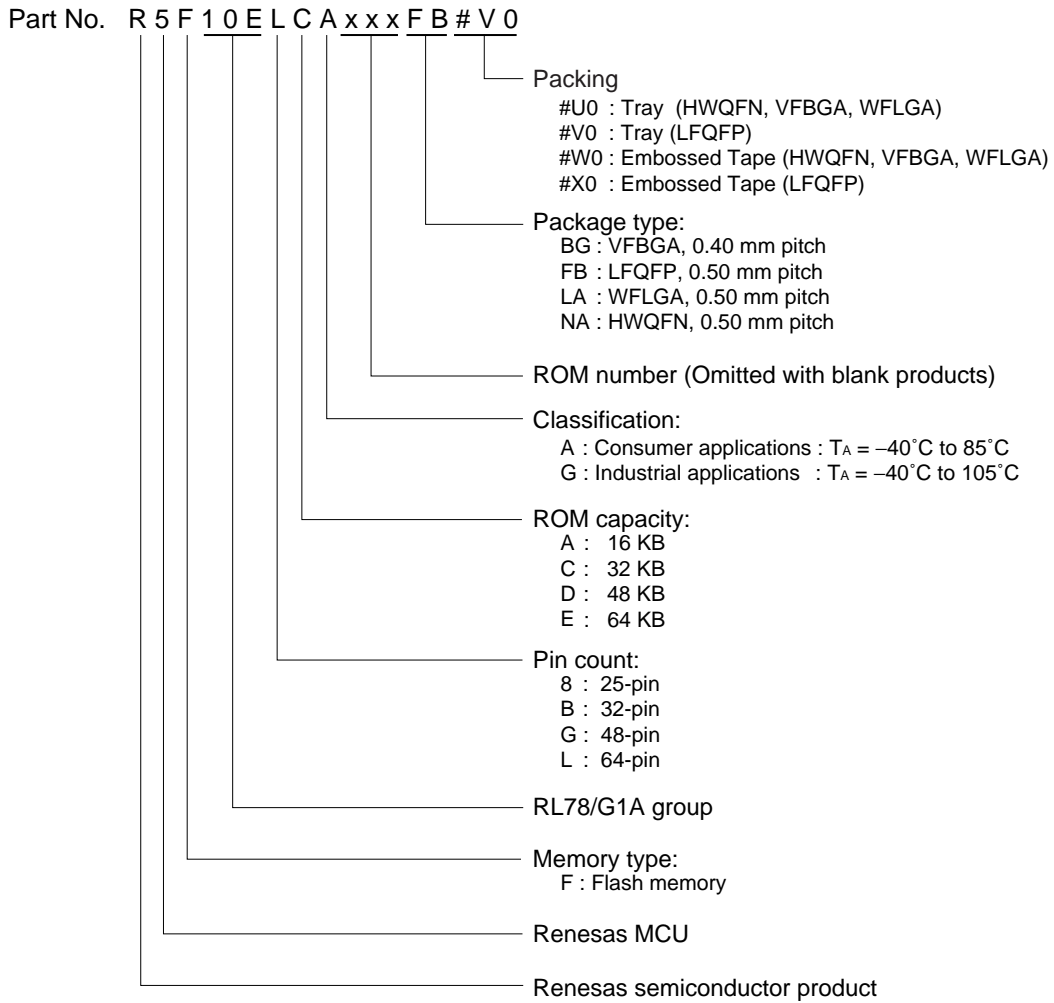

**Caution** The part number above is valid as of when this manual was issued. For the latest part number, see the web page of the target product on the Renesas Electronics website.

&lt;R&gt;

Table 1-1. List of Ordering Part Numbers

Pin count	Package	Fields of Application <sup>Note</sup>	Ordering Part Number
25 pins	25-pin plastic WFLGA (3 × 3 mm, 0.5 mm pitch)	A	R5F10E8AALA#U0, R5F10E8CALA#U0, R5F10E8DALA#U0, R5F10E8EALA#U0, R5F10E8AALA#W0, R5F10E8CALA#W0, R5F10E8DALA#W0, R5F10E8EALA#W0
		G	R5F10E8AGLA#U0, R5F10E8CGLA#U0, R5F10E8DGLA#U0, R5F10E8EGLA#U0, R5F10E8AGLA#W0, R5F10E8CGLA#W0, R5F10E8DGLA#W0, R5F10E8EGLA#W0
32 pins	32-pin plastic HWQFN (5 × 5 mm, 0.5 mm pitch)	A	R5F10EBAANA#U0, R5F10EBCANA#U0, R5F10EBDANA#U0, R5F10EBEANA#U0, R5F10EBAANA#W0, R5F10EBCANA#W0, R5F10EBDANA#W0, R5F10EBEANA#W0
		G	R5F10EBAGNA#U0, R5F10EBCGNA#U0, R5F10EBDGNA#U0, R5F10EBEGNA#U0, R5F10EBAGNA#W0, R5F10EBCGNA#W0, R5F10EBDGNA#W0, R5F10EBEGNA#W0
48 pins	48-pin plastic LFQFP (7 × 7 mm, 0.5 mm pitch)	A	R5F10EGAAFV0, R5F10EGCAFV0, R5F10EGDAFV0, R5F10EGEAFV0, R5F10EGAAFV0, R5F10EGCAFV0, R5F10EGDAFV0, R5F10EGEAFV0
		G	R5F10EBAGNV0, R5F10EBCGNV0, R5F10EBDGNV0, R5F10EBEGNV0, R5F10EBAGNV0, R5F10EBCGNV0, R5F10EBDGNV0, R5F10EBEGNV0
	48-pin plastic HWQFN (7 × 7 mm, 0.5 mm pitch)	A	R5F10EGAANA#U0, R5F10EGCANA#U0, R5F10EGDANA#U0, R5F10EGEANA#U0, R5F10EGAANA#W0, R5F10EGCANA#W0, R5F10EGDANA#W0, R5F10EGEANA#W0
		G	R5F10EGAGNV0, R5F10EGCGNV0, R5F10EGDGNV0, R5F10EGEGNV0, R5F10EGAGNV0, R5F10EGCGNV0, R5F10EGDGNV0, R5F10EGEGNV0
64 pins	64-pin plastic LFQFP (10 × 10 mm, 0.5 mm pitch)	A	R5F10ELCAFV0, R5F10ELDADFV0, R5F10ELEAFV0, R5F10ELCAFV0, R5F10ELDADFV0, R5F10ELEAFV0
		G	R5F10ELCGFV0, R5F10ELDGFV0, R5F10ELEGFV0, R5F10ELCGFV0, R5F10ELDGFV0, R5F10ELEGFV0
	64-pin plastic VFPGA (4 × 4 mm, 0.4 mm pitch)	A	R5F10ELCABG#U0, R5F10ELDABG#U0, R5F10ELEABG#U0, R5F10ELCABG#W0, R5F10ELDABG#W0, R5F10ELEABG#W0
		G	R5F10ELCGBG#U0, R5F10ELDGBG#U0, R5F10ELEGBG#U0, R5F10ELCGBG#W0, R5F10ELDGBG#W0, R5F10ELEGBG#W0

<R> **Note** For the fields of application, see **Figure 1-1 Part Number, Memory Size, and Package of RL78/G1A**.

**Caution** The part number above is valid as of when this manual was issued. For the latest part number, see the web page of the target product on the Renesas Electronics website.

1.3 Pin Configuration (Top View)

1.3.1 25-pin products

- 25-pin plastic WFLGA (3 × 3 mm, 0.50 mm pitch)

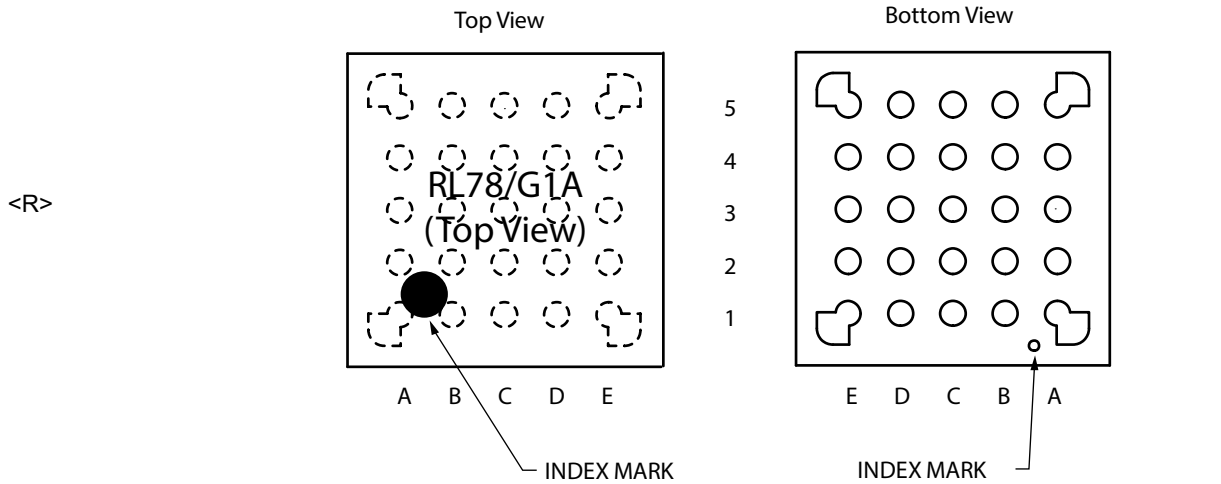

	A	B	C	D	E	
5	P40/TOOL0	RESET	P03/ANI16/ RxD1/TO00/ (KR1)	P23/ANI3/ (KR3)	AV <sub>SS</sub>	5
4	P122/X2/ EXCLK	P137/INTP0	P02/ANI17/ TxD1/TI00/ (KR0)	P22/ANI2/ (KR2)	AV <sub>DD</sub>	4
3	P121/X1	V <sub>DD</sub>	P21/ANI1/ AV <sub>REFM</sub>	P11/ANI20/ SI00/SDA00/ RxD0/ TOOLRxD	P10/ANI18/ SCK00/SCL00	3
2	REGC	V <sub>SS</sub>	P30/ANI27/ SCK11/SCL11/ INTP3	P51/ANI25/ SO11/INTP2	P50/ANI26/ SI11/SDA11 INTP1	2
1	P60/SCLA0	P61/SDAA0	P31/ANI29/TI03/ TO03/PCLBUZ0 /INTP4	P12/ANI21/ SO00/TxD0/ TOOLTxD	P20/ANI0/ AV <sub>REFP</sub>	1
	A	B	C	D	E	

**Caution** Connect the REGC pin to V<sub>SS</sub> via a capacitor (0.47 to 1 μF).

**Remarks 1.** For pin identification, see 1.4 Pin Identification.

2. Functions in parentheses in the above figure can be assigned via settings in the peripheral I/O redirection register (PIOR).

1.3.2 32-pin products

- 32-pin plastic HWQFN (5 × 5 mm, 0.5 mm pitch)

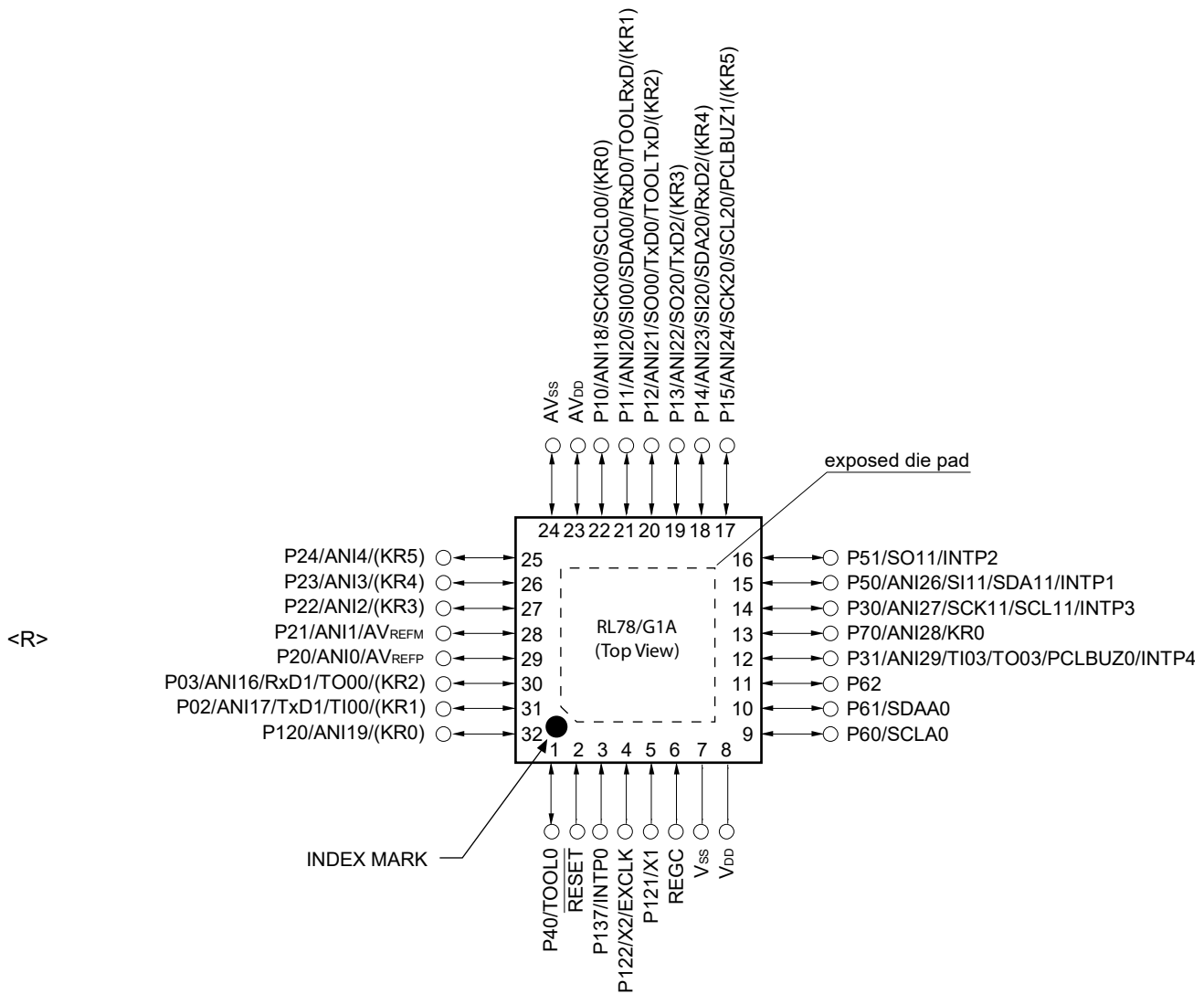

**Caution** Connect the REGC pin to V<sub>SS</sub> via a capacitor (0.47 to 1 μF).

**Remarks 1.** For pin identification, see 1.4 Pin Identification.

2. Functions in parentheses in the above figure can be assigned via settings in the peripheral I/O redirection register (PIOR).

3. It is recommended to connect an exposed die pad to V<sub>SS</sub>.

1.3.3 48-pin products

- 48-pin plastic LQFP (7 × 7 mm, 0.5 mm pitch)

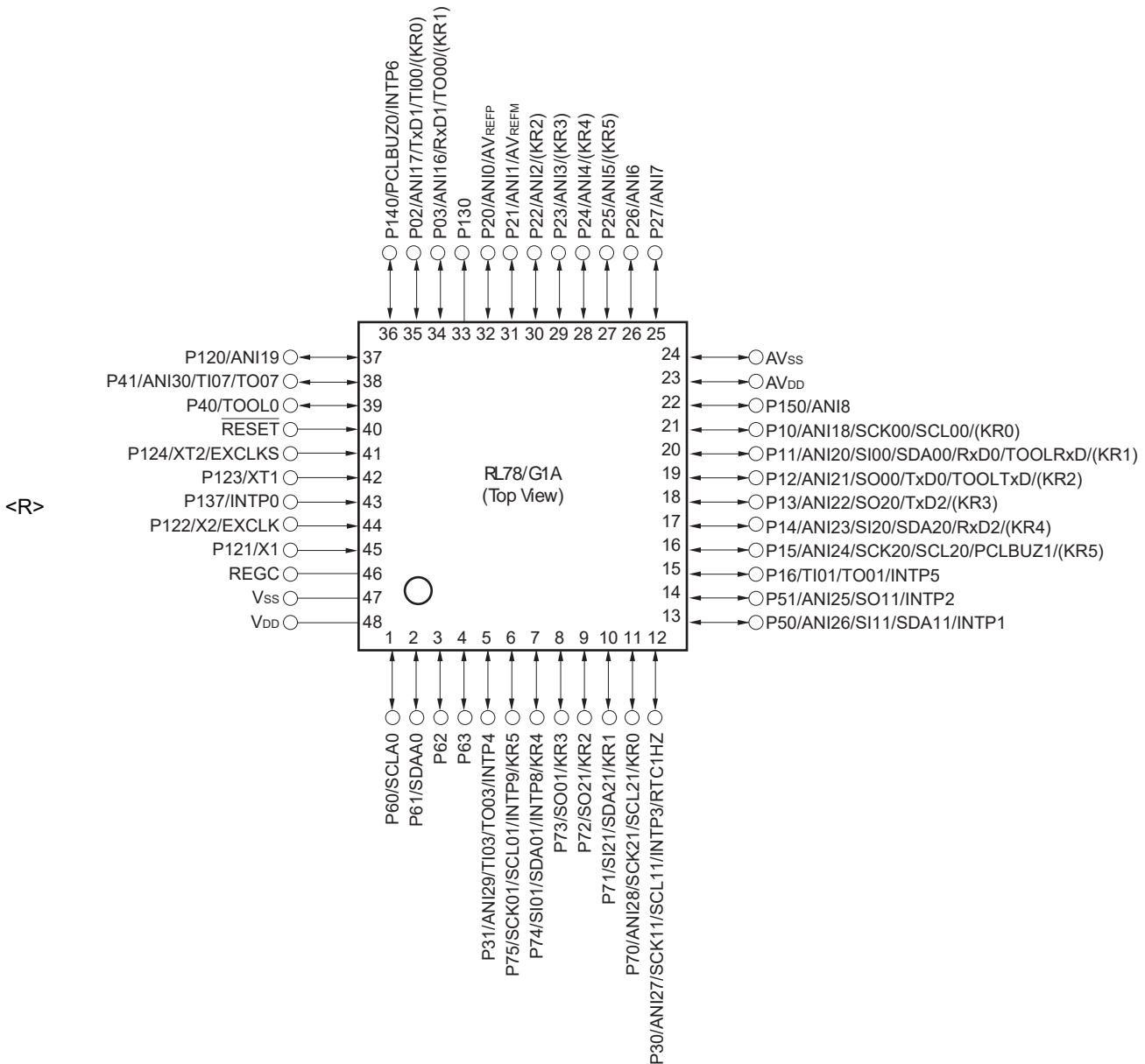

**Caution** Connect the REGC pin to V<sub>SS</sub> via a capacitor (0.47 to 1 μF).

**Remarks 1.** For pin identification, see 1.4 Pin Identification.

2. Functions in parentheses in the above figure can be assigned via settings in the peripheral I/O redirection register (PIOR).

- 48-pin plastic HWQFN (7 × 7 mm, 0.5 mm pitch)

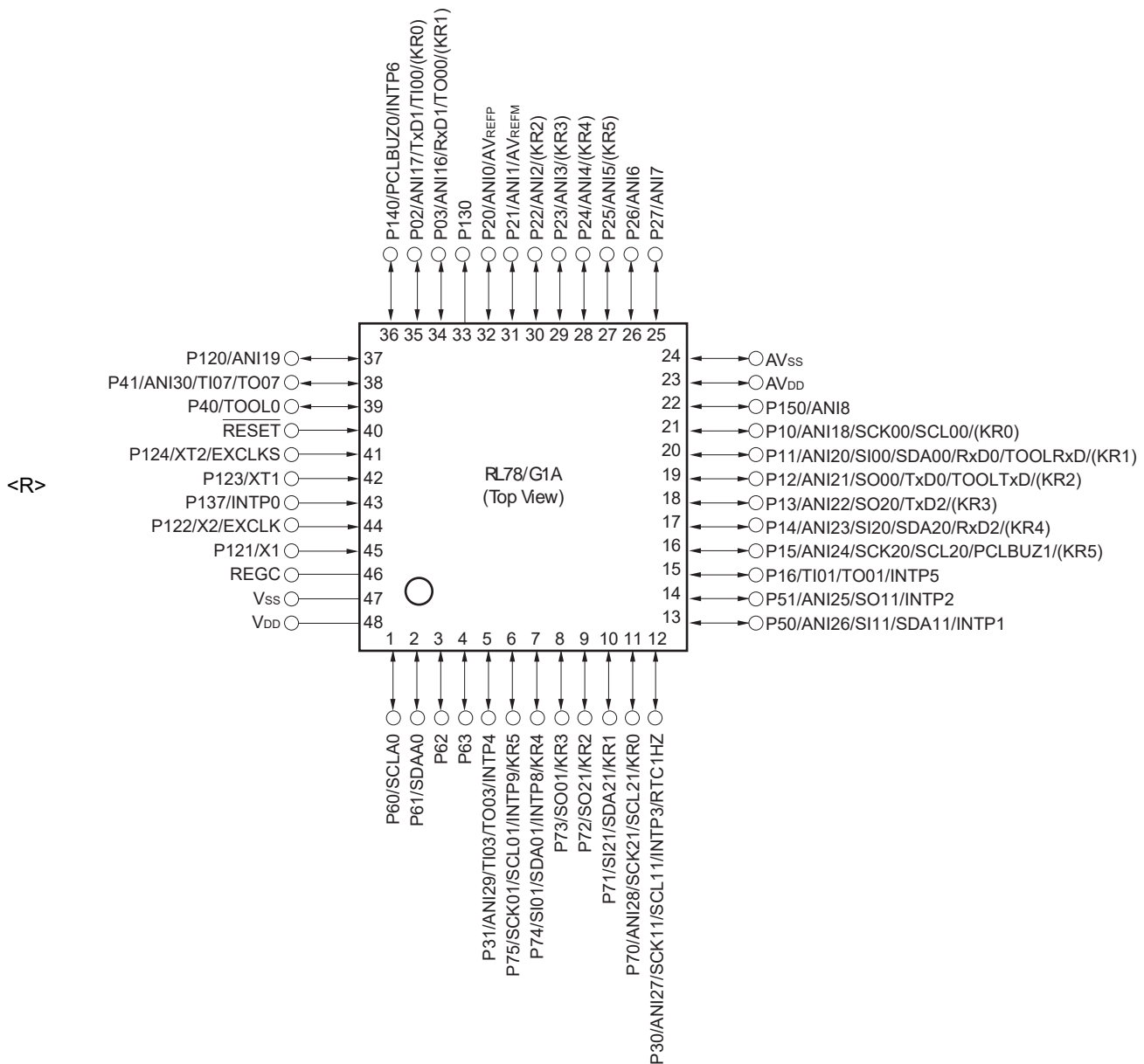

**Caution** Connect the REGC pin to V<sub>SS</sub> via a capacitor (0.47 to 1 μF).

**Remarks 1.** For pin identification, see 1.4 Pin Identification.

2. Functions in parentheses in the above figure can be assigned via settings in the peripheral I/O redirection register (PIOR).



1.3.4 64-pin products

- 64-pin plastic LFQFP (10 × 10 mm, 0.5 mm pitch)

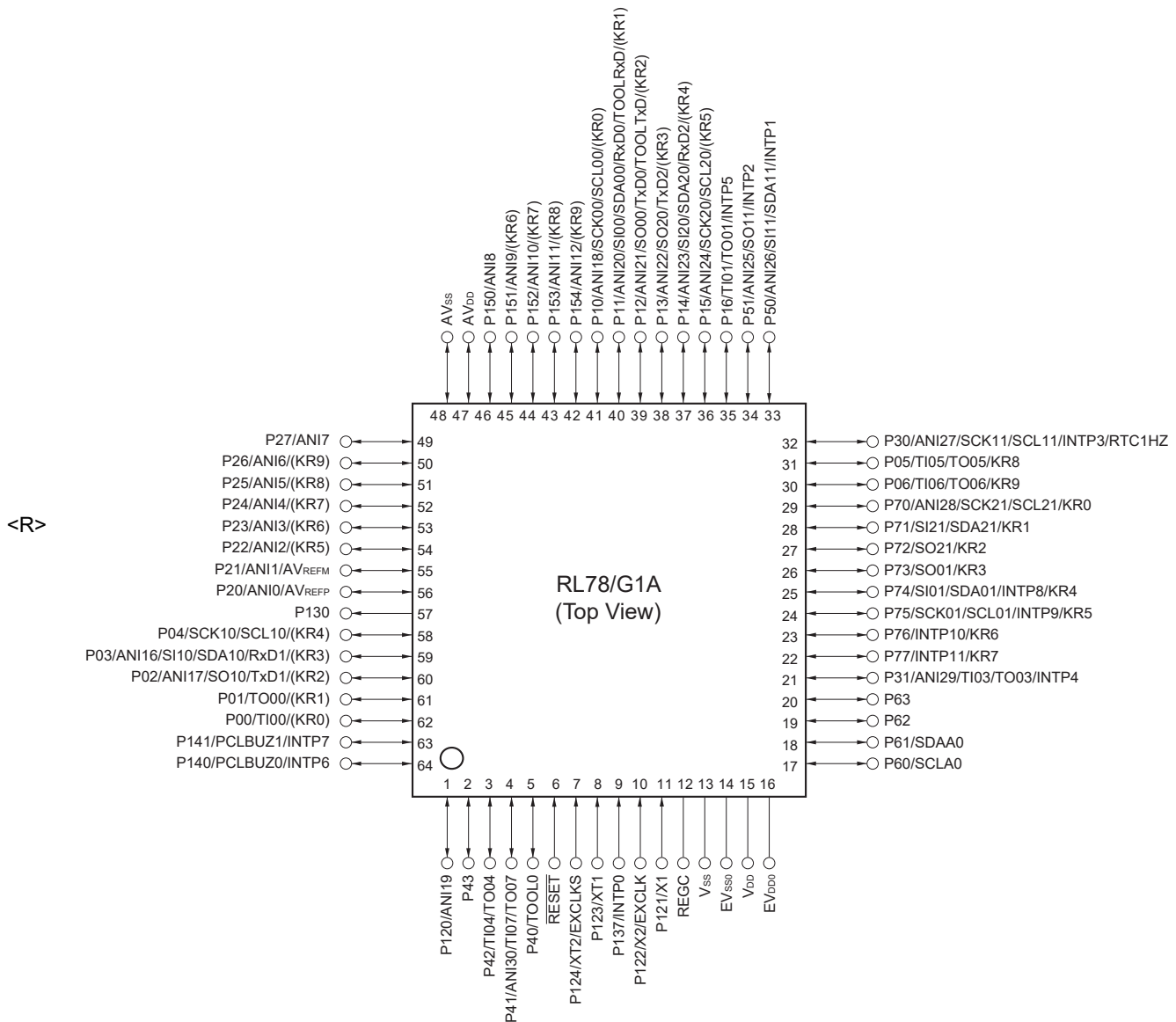

- Cautions 1.** Make EV<sub>SS0</sub> pin the same potential as V<sub>SS</sub> pin.
- Make V<sub>DD</sub> pin the potential that is higher than EV<sub>DD0</sub> pin.
  - Connect the REGC pin to V<sub>SS</sub> via a capacitor (0.47 to 1 μF).

**Remarks 1.** For pin identification, see 1.4 Pin Identification.

- When using the microcontroller for an application where the noise generated inside the microcontroller must be reduced, it is recommended to supply separate powers to the V<sub>DD</sub> and EV<sub>DD0</sub> pins and connect the V<sub>SS</sub> and EV<sub>SS0</sub> pins to separate ground lines.
- Functions in parentheses in the above figure can be assigned via settings in the peripheral I/O redirection register (PIOR).

- 64-pin plastic VFBGA (4 × 4 mm, 0.4 mm pitch)

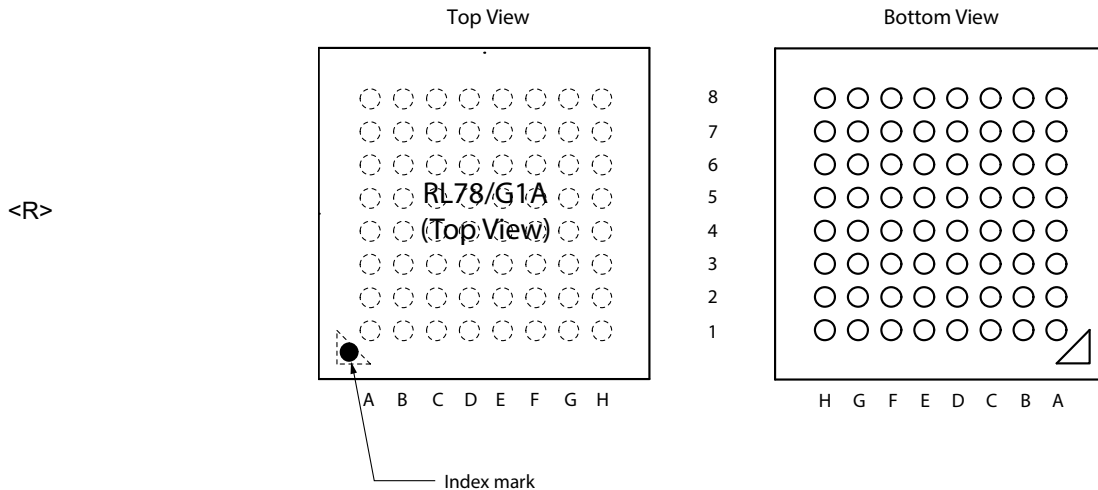

Pin No.	Name	Pin No.	Name	Pin No.	Name	Pin No.	Name
A1	P05/TI05/TO05/KR8	C1	P51/ANI25/SO11 /INTP2	E1	P153/ANI11/(KR8)	G1	AV <sub>DD</sub>
A2	P30/ANI27/SCK11 /SCL11/INTP3 /RTC1HZ	C2	P71/SI21/SDA21/KR1	E2	P154/ANI12/(KR9)	G2	P25/ANI5/(KR8)
A3	P70/ANI28/SCK21 /SCL21/KR0	C3	P74/SI01/SDA01 /INTP8/KR4	E3	P10/ANI18/SCK00 /SCL00/(KR0)	G3	P24/ANI4/(KR7)
A4	P75/SCK01/SCL01 /INTP9/KR5	C4	P16/TI01/TO01/INTP5	E4	P11/ANI20/SI00 /SDA00/RxD0 /TOOLRxD/(KR1)	G4	P22/ANI2/(KR5)
A5	P77/INTP11/KR7	C5	P15/ANI24/SCK20 /SCL20/(KR5)	E5	P03/ANI16/SI10 /SDA10/RxD1/(KR3)	G5	P130
A6	P61/SDAA0	C6	P63	E6	P41/ANI30/TI07/TO07	G6	P02/ANI17/SO10/TxD1 /(KR2)
A7	P60/SCLA0	C7	V <sub>SS</sub>	E7	RESET	G7	P00/TI00/(KR0)
A8	EV <sub>DD0</sub>	C8	P121/X1	E8	P137/INTP0	G8	P124/XT2/EXCLKS
B1	P50/ANI26 /SI11 /SDA11/INTP1	D1	P13/ANI22/SO20 /TxD2/(KR3)	F1	P150/ANI8	H1	AV <sub>SS</sub>
B2	P72/SO21/KR2	D2	P06/TI06/TO06/KR9	F2	P151/ANI9/(KR6)	H2	P27/ANI7
B3	P73/SO01/KR3	D3	P12/ANI21/SO00 /TxD0/TOOLTxD/(KR2)	F3	P152/ANI10/(KR7)	H3	P26/ANI6/(KR9)
B4	P76/INTP10/KR6	D4	P14/ANI23/SI20/ SDA20/RxD2/(KR4)	F4	P21/ANI1/AV <sub>REFM</sub>	H4	P23/ANI3/(KR6)
B5	P31/ANI29/TI03/TO03 /INTP4	D5	P42/TI04/TO04	F5	P04/SCK10/SCL10 /(KR4)	H5	P20/ANI0/AV <sub>REFP</sub>
B6	P62	D6	P40/TOOL0	F6	P43	H6	P141/PCLBUZ1/INTP7
B7	V <sub>DD</sub>	D7	REGC	F7	P01/TO00/(KR1)	H7	P140/PCLBUZ0/INTP6
B8	EV <sub>SS0</sub>	D8	P122/X2/EXCLK	F8	P123/XT1	H8	P120/ANI19

- Cautions**
1. Make EV<sub>SS0</sub> pin the same potential as V<sub>SS</sub> pin.
  2. Make V<sub>DD</sub> pin the potential that is higher than EV<sub>DD0</sub> pin.
  3. Connect the REGC pin to V<sub>SS</sub> via a capacitor (0.47 to 1 μF).

- Remarks**
1. For pin identification, see 1.4 Pin Identification.
  2. When using the microcontroller for an application where the noise generated inside the microcontroller must be reduced, it is recommended to supply separate powers to the V<sub>DD</sub> and EV<sub>DD0</sub> pins and connect the V<sub>SS</sub> and EV<sub>SS0</sub> pins to separate ground lines.
  3. Functions in parentheses in the above figure can be assigned via settings in the peripheral I/O redirection register (PIOR).

## 1.4 Pin Identification

ANI0 to ANI12,		PCLBUZ0, PCLBUZ1:	Programmable clock output/buzzer output
ANI16 to ANI30:	Analog input		
AVDD:	Analog power supply	REGC:	Regulator capacitance
AVSS:	Analog ground	RESET:	Reset
AVREFM:	A/D converter reference potential (– side) input	RTC1HZ:	Real-time clock correction clock (1 Hz) output
AVREFP:	A/D converter reference potential (+ side) input	RxD0 to RxD2:	Receive data
EVDD0:	Power supply for port	SCK00, SCK01, SCK10,	
EVSS0:	Ground for port	SCK11, SCK20, SCK21:	Serial clock input/output
EXCLK:	External clock input (main system clock)	SCLA0, SCL00, SCL01,	
		SCL10, SCL11, SCL20,	
		SCL21:	Serial clock output
EXCLKS:	External clock input (subsystem clock)	SDAA0, SDA00, SDA01,	
		SDA10, SDA11, SDA20,	
INTP0 to INTP11:	Interrupt Request from External	SDA21:	Serial data input/output
		SI00, SI01, SI10, SI11,	
KR0 to KR9:	Key return	SI20, SI21:	Serial data input
P00 to P06:	Port 0	SO00, SO01, SO10,	
P10 to P16:	Port 1	SO11, SO20, SO21:	Serial data output
P20 to P27:	Port 2	TI00, TI01, TI03 to TI07:	Timer input
P30, P31:	Port 3	TO00, TO01,	
P40 to P43:	Port 4	TO03 to TO07:	Timer output
P50, P51:	Port 5	TOOL0:	Data input/output for tool
P60 to P63:	Port 6	TOOLRxD, TOOLTxD:	Data input/output for external device
P70 to P77:	Port 7	TxD0 to TxD2:	Transmit data
P120 to P124:	Port 12	VDD:	Power supply
P130, P137:	Port 13	VSS:	Ground
P140, P141:	Port 14	X1, X2:	Crystal oscillator (main system clock)
P150 to P154:	Port 15	XT1, XT2:	Crystal oscillator (subsystem clock)

1.5 Block Diagram

1.5.1 25-pin products

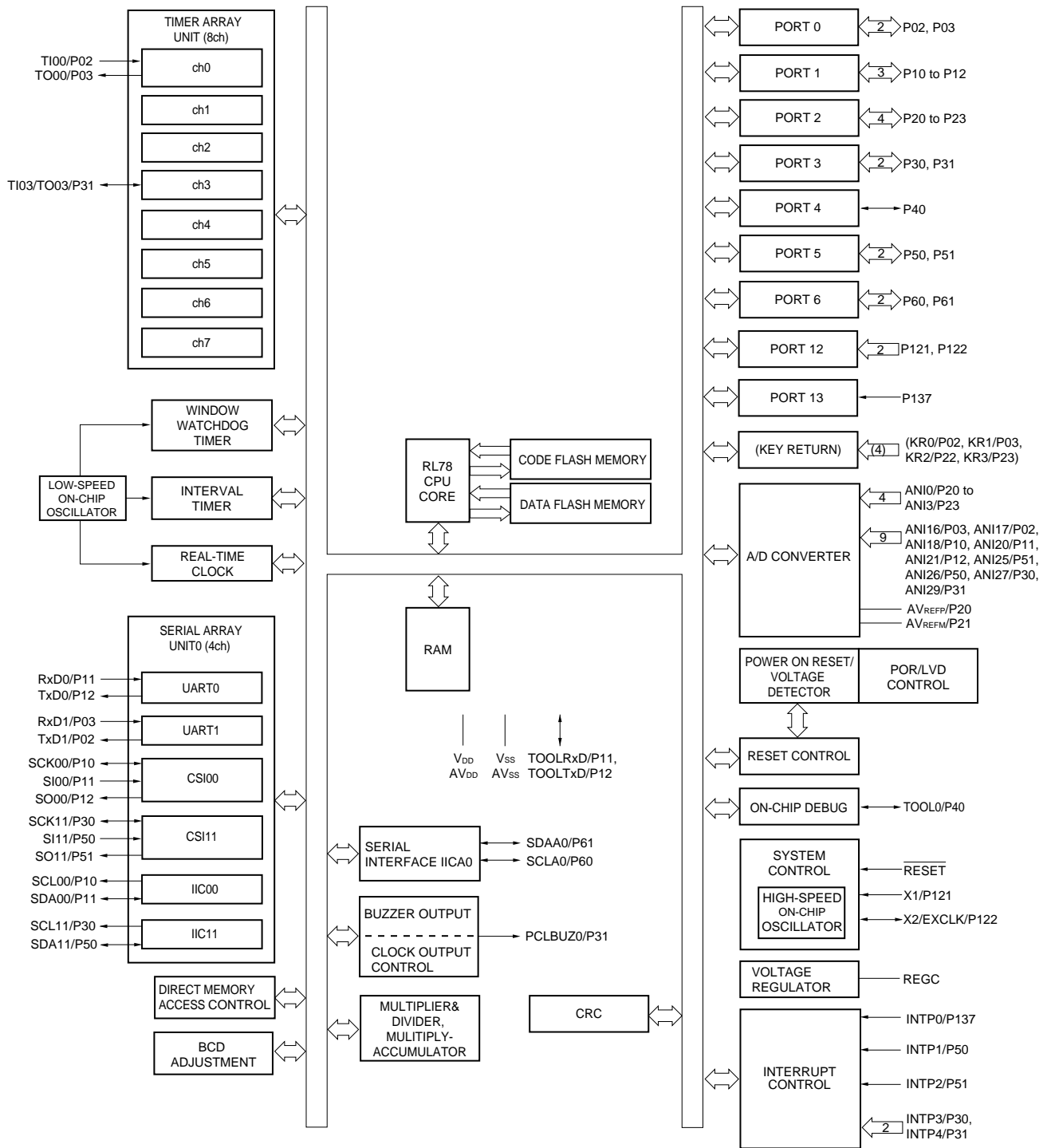

**Remark** Functions in parentheses in the above figure can be assigned via settings in the peripheral I/O redirection register (PIOR).

<R> 1.5.2 32-pin products

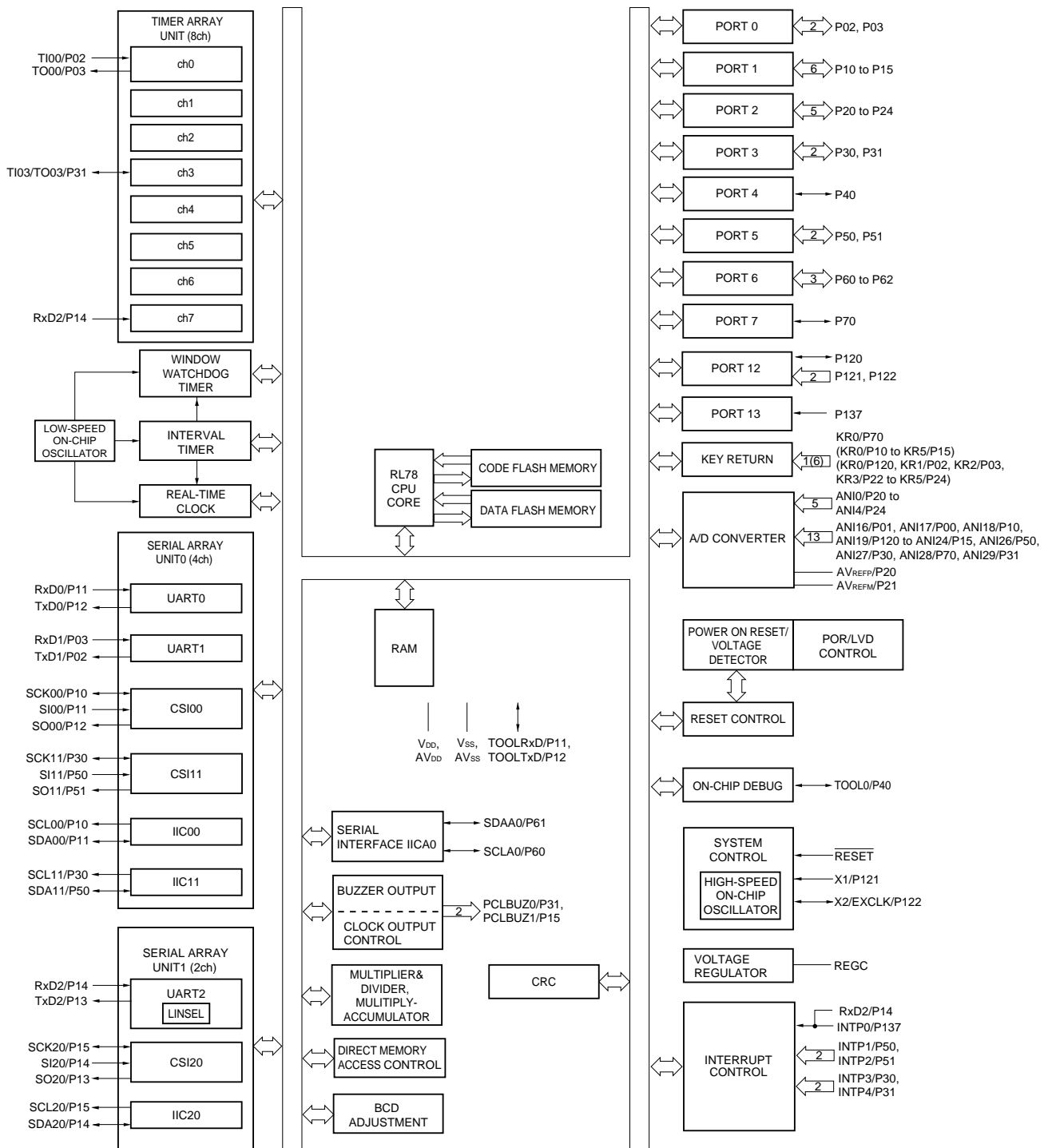

**Remark** Functions in parentheses in the above figure can be assigned via settings in the peripheral I/O redirection register (PIOR).

<R> 1.5.3 48-pin products

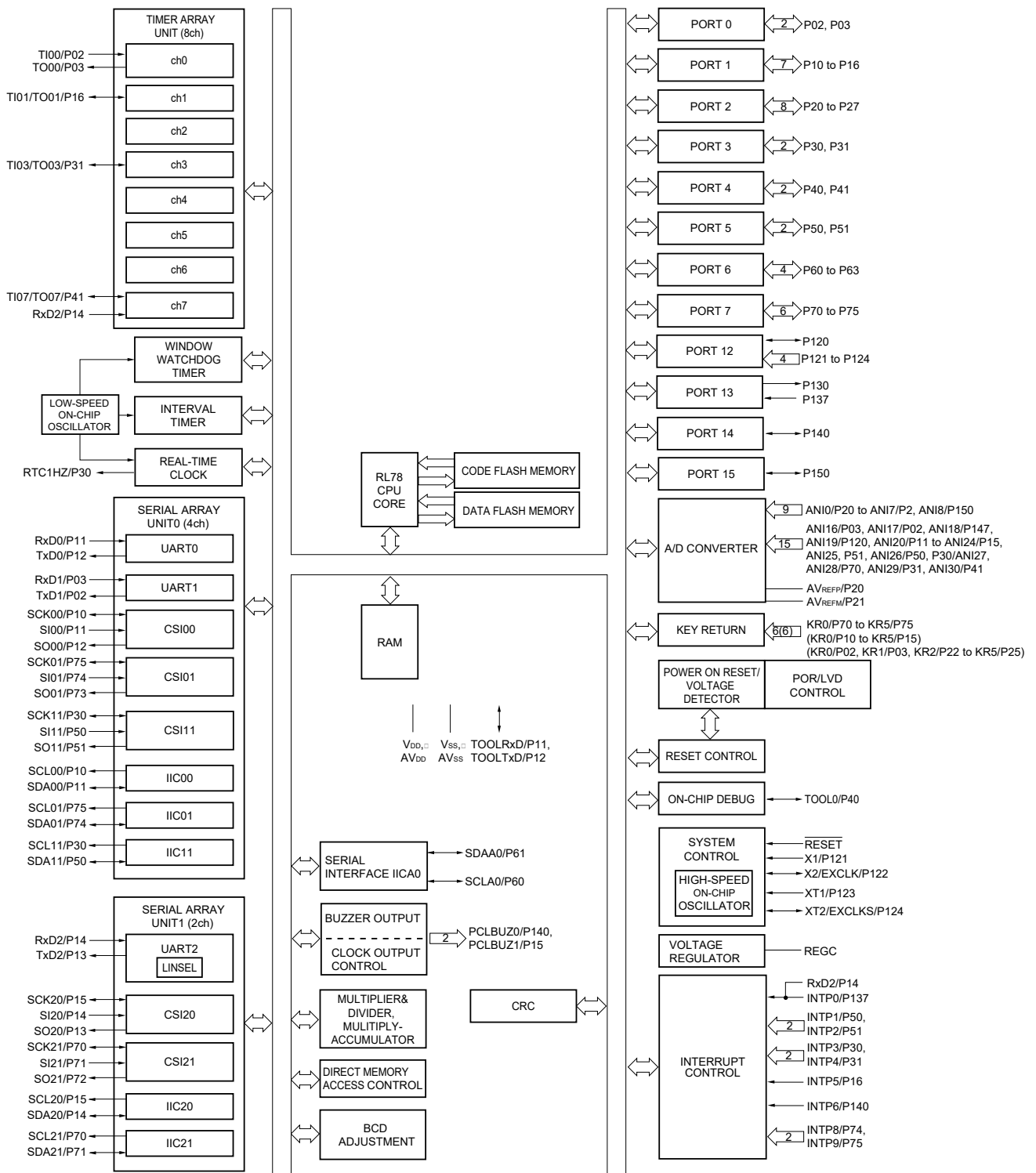

**Remark** Functions in parentheses in the above figure can be assigned via settings in the peripheral I/O redirection register (PIOR).

1.5.4 64-pin products

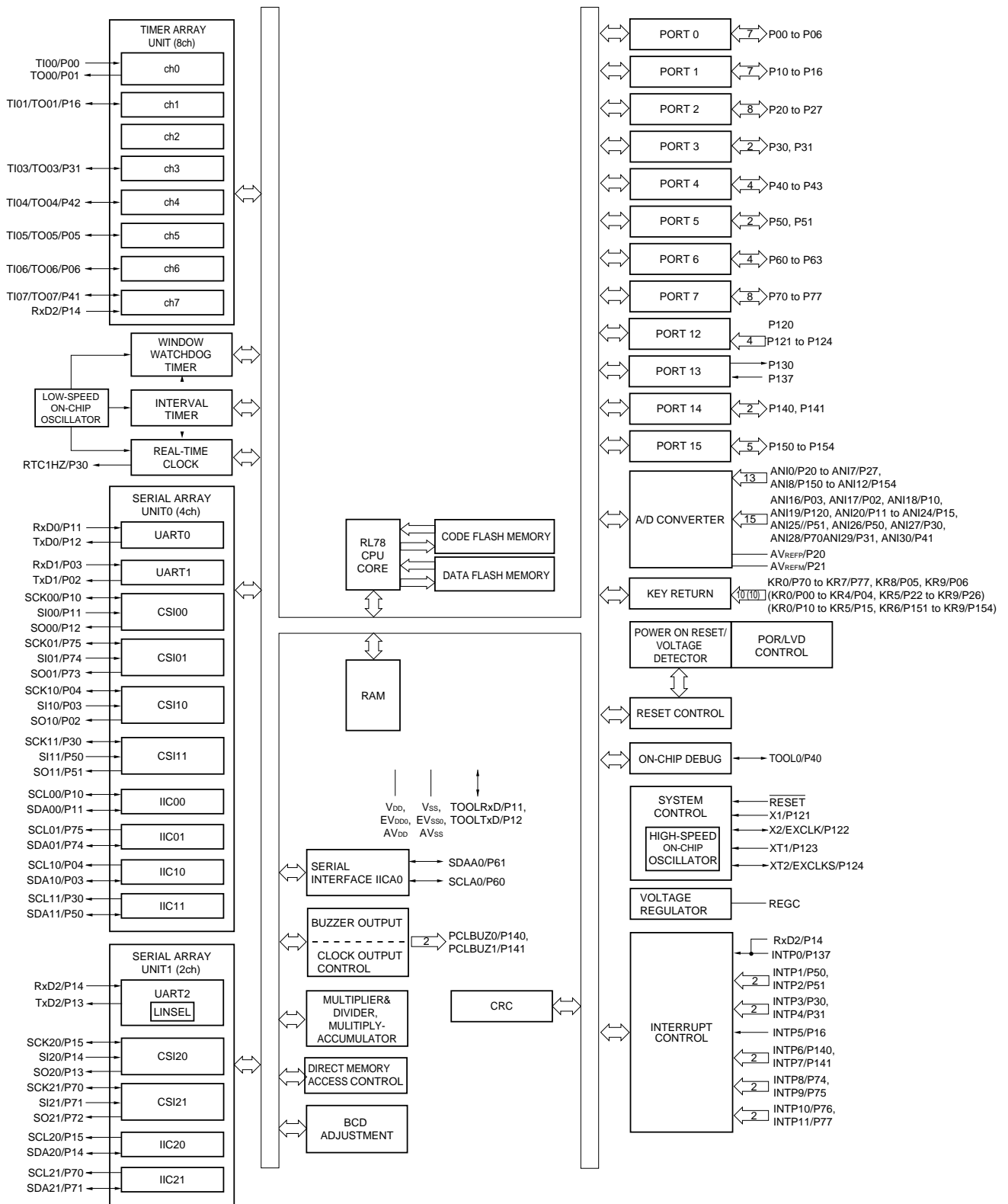

**Remark** Functions in parentheses in the above figure can be assigned via settings in the peripheral I/O redirection register (PIOR).

## 1.6 Outline of Functions

(1/2)

Item		25-pin	32-pin	48-pin	64-pin	
		R5F10E8x	R5F10EBx	R5F10EGx	R5F10ELx	
Code flash memory (KB)		16 to 64	16 to 64	16 to 64	32 to 64	
Data flash memory (KB)		4	4	4	4	
RAM (KB)		2 to 4 <sup>Note 1</sup>	2 to 4 <sup>Note 1</sup>	2 to 4 <sup>Note 1</sup>	2 to 4 <sup>Note 1</sup>	
Address space		1 MB				
<R>	Main system clock	X1 (crystal/ceramic) oscillation, external main system clock input (EXCLK) HS (High-speed main) mode: 1 to 20 MHz ( $V_{DD} = 2.7$ to $3.6$ V), HS (High-speed main) mode: 1 to 16 MHz ( $V_{DD} = 2.4$ to $3.6$ V), LS (Low-speed main) mode: 1 to 8 MHz ( $V_{DD} = 1.8$ to $3.6$ V), LV (Low-voltage main) mode: 1 to 4 MHz ( $V_{DD} = 1.6$ to $3.6$ V)				
	High-speed system clock	HS (High-speed main) mode : 1 to 32 MHz ( $V_{DD} = 2.7$ to $3.6$ V), HS (High-speed main) mode : 1 to 16 MHz ( $V_{DD} = 2.4$ to $3.6$ V), LS (Low-speed main) mode : 1 to 8 MHz ( $V_{DD} = 1.8$ to $3.6$ V), LV (Low-voltage main) mode : 1 to 4 MHz ( $V_{DD} = 1.6$ to $3.6$ V)				
Subsystem clock		-		XT1 (crystal) oscillation, external subsystem clock input (EXCLKS) 32.768 kHz (TYP.)		
Low-speed on-chip oscillator		15 kHz (TYP.)				
General-purpose register		(8-bit register $\times$ 8) $\times$ 4 bank				
Minimum instruction execution time		0.03125 $\mu$ s (High-speed on-chip oscillator: $f_{IH} = 32$ MHz operation)				
		0.05 $\mu$ s (High-speed system clock: $f_{MX} = 20$ MHz operation)				
		-		30.5 $\mu$ s (Subsystem clock: $f_{SUB} = 32.768$ kHz operation)		
Instruction set		<ul style="list-style-type: none"> <li>Data transfer (8/16 bits)</li> <li>Adder and subtractor/logical operation (8/16 bits)</li> <li>Multiplication (8 bits <math>\times</math> 8 bits)</li> <li>Rotate, barrel shift, and bit manipulation (Set, reset, test, and Boolean operation), etc.</li> </ul>				
<R>	I/O port	Total	19	26	42	56
	CMOS I/O	14 (N-ch O.D. I/O [ $V_{DD}$ withstand voltage]: 6)	20 (N-ch O.D. I/O [ $V_{DD}$ withstand voltage]: 9)	32 (N-ch O.D. I/O [ $V_{DD}$ withstand voltage]: 11)	46 (N-ch O.D. I/O [ $V_{DD}$ withstand voltage]: 12)	
	CMOS input	3	3	5	5	
	CMOS output	-	-	1	1	
	N-ch open-drain I/O (6 V tolerance)	2	3	4	4	
Timer	16-bit timer	8 channels				
	Watchdog timer	1 channel				
	Real-time clock (RTC)	1 channel <sup>Note 2</sup>		1 channel		
	12-bit interval timer (IT)	1 channel				
	Timer output	2 channels (PWM outputs: 1 <sup>Note 3</sup> )		4 channels (PWM outputs: 3 <sup>Note 3</sup> )	7 channels (PWM outputs: 6 <sup>Note 3</sup> )	
	RTC output	-		1	<ul style="list-style-type: none"> <li>1 Hz (subsystem clock: <math>f_{SUB} = 32.768</math> kHz)</li> </ul>	

**Notes 1.** In the case of the 4 KB, this is about 3 KB when the self-programming function and data flash function are used. (For details, see **CHAPTER 3. ELECTRICAL SPECIFICATIONS (G: INDUSTRIAL APPLICATIONS  $T_A = -40$  to  $+105^\circ\text{C}$ )**)

- <R>
- Only the constant-period interrupt function when the low-speed on-chip oscillator clock ( $f_{IL}$ ) is selected.
  - The number of PWM outputs varies depending on the setting of channels in use (the number of masters and slaves). (**6.9.3 Operation as multiple PWM output function**).



(2/2)

Item	25-pin	32-pin	48-pin	64-pin
	R5F10E8x	R5F10EBx	R5F10EGx	R5F10ELx
Clock output/buzzer output	1	2	2	2
	<ul style="list-style-type: none"> <li>2.44 kHz, 4.88 kHz, 9.76 kHz, 1.25 MHz, 2.5 MHz, 5 MHz, 10 MHz (Main system clock: <math>f_{MAIN} = 20</math> MHz operation)</li> </ul>		<ul style="list-style-type: none"> <li>2.44 kHz, 4.88 kHz, 9.76 kHz, 1.25 MHz, 2.5 MHz, 5 MHz, 10 MHz (Main system clock: <math>f_{MAIN} = 20</math> MHz operation)</li> <li>256 Hz, 512 Hz, 1.024 kHz, 2.048 kHz, 4.096 kHz, 8.192 kHz, 16.384 kHz, 32.768 kHz (Subsystem clock: <math>f_{SUB} = 32.768</math> kHz operation)</li> </ul>	
8/12-bit resolution A/D converter	13 channels	18 channels	24 channels	28 channels
Serial interface	<p>[25-pin products]</p> <ul style="list-style-type: none"> <li>CSI: 1 channel/simplified I<sup>2</sup>C: 1 channel/UART: 1 channel</li> <li>CSI: 1 channel/simplified I<sup>2</sup>C: 1 channel/UART: 1 channel</li> </ul> <p>[32-pin products]</p> <ul style="list-style-type: none"> <li>CSI: 1 channel/simplified I<sup>2</sup>C: 1 channel/UART: 1 channel</li> <li>CSI: 1 channel/simplified I<sup>2</sup>C: 1 channel/UART: 1 channel</li> <li>CSI: 1 channel/simplified I<sup>2</sup>C: 1 channel/UART (UART supporting LIN-bus): 1 channel</li> </ul> <p>[48-pin products]</p> <ul style="list-style-type: none"> <li>CSI: 2 channels/simplified I<sup>2</sup>C: 2 channels/UART: 1 channel</li> <li>CSI: 1 channel/simplified I<sup>2</sup>C: 1 channel/UART: 1 channel</li> <li>CSI: 2 channels/simplified I<sup>2</sup>C: 2 channels/UART (UART supporting LIN-bus): 1 channel</li> </ul> <p>[64-pin products]</p> <ul style="list-style-type: none"> <li>CSI: 2 channels/simplified I<sup>2</sup>C: 2 channels/UART: 1 channel</li> <li>CSI: 2 channels/simplified I<sup>2</sup>C: 2 channels/UART: 1 channel</li> <li>CSI: 2 channels/simplified I<sup>2</sup>C: 2 channels/UART (UART supporting LIN-bus): 1 channel</li> </ul>			
I <sup>2</sup> C bus	1 channel	1 channel	1 channel	1 channel
Multiplier and divider/multiply-accumulator	<ul style="list-style-type: none"> <li>16 bits × 16 bits = 32 bits (Unsigned or signed)</li> <li>32 bits ÷ 32 bits = 32 bits (Unsigned)</li> <li>16 bits × 16 bits + 32 bits = 32 bits (Unsigned or signed)</li> </ul>			
DMA controller	2 channels			
Vectored interrupt sources	Internal	24	27	27
	External	6	6	10
Key interrupt	0 ch (4 ch) <sup>Note 1</sup>	1 ch (6 ch) <sup>Note 1</sup>	6 ch	10 ch
Reset	<ul style="list-style-type: none"> <li>Reset by RESET pin</li> <li>Internal reset by watchdog timer</li> <li>Internal reset by power-on-reset</li> <li>Internal reset by voltage detector</li> <li>Internal reset by illegal instruction execution<sup>Note 2</sup></li> <li>Internal reset by RAM parity error</li> <li>Internal reset by illegal-memory access</li> </ul>			
Power-on-reset circuit	<ul style="list-style-type: none"> <li>Power-on-reset: 1.51 V (TYP.)</li> <li>Power-down-reset: 1.50 V (TYP.)</li> </ul>			
Voltage detector	<ul style="list-style-type: none"> <li>Rising edge : 1.67 V to 3.14 V (12 stages)</li> <li>Falling edge : 1.63 V to 3.06 V (12 stages)</li> </ul>			
On-chip debug function	Provided			
Power supply voltage	$V_{DD} = 1.6$ to $3.6$ V			
Operating ambient temperature	$T_A = -40$ to $+85^\circ\text{C}$ (A: Consumer application), $T_A = -40$ to $+105^\circ\text{C}$ (G: Industrial application)			

**Notes** 1. Can be used by the Peripheral I/O redirection register (PIOR).

2. The illegal instruction is generated when instruction code FFH is executed.

Reset by the illegal instruction execution not issued by emulation with the in-circuit emulator or on-chip debug emulator.

## 2. ELECTRICAL SPECIFICATIONS ( $T_A = -40$ to $+85^\circ\text{C}$ )

This chapter describes the following electrical specifications.

Target products A: Consumer applications  $T_A = -40$  to  $+85^\circ\text{C}$

R5F10E8AALA, R5F10E8CALA, R5F10E8DALA, R5F10E8EALA  
 R5F10EBAANA, R5F10EBCANA, R5F10EBDANA, R5F10EBEANA  
 R5F10EGAAFb, R5F10EGCAFb, R5F10EGDAFb, R5F10EGEAFb  
 R5F10EGAANA, R5F10EGCANA, R5F10EGDANA, R5F10EGEANA  
 R5F10ELCAFb, R5F10ELDAFb, R5F10ELEAFb  
 R5F10ELCABG, R5F10ELDABG, R5F10ELEABG

G: Industrial applications When  $T_A = -40$  to  $+105^\circ\text{C}$  products is used in the range of  $T_A = -40$  to  $+85^\circ\text{C}$

R5F10EBAGNA, R5F10EBCGNA, R5F10EBDGNA, R5F10EBEGNA  
 R5F10EGAGFb, R5F10EGCGFb, R5F10EGDGFb, R5F10EGEGFb  
 R5F10EGAGNA, R5F10EGCGNA, R5F10EGDGNNA, R5F10EGEGNA  
 R5F10ELCGFb, R5F10ELDGFb, R5F10ELEGFb

- Cautions**
1. The RL78 microcontrollers have an on-chip debug function, which is provided for development and evaluation. Do not use the on-chip debug function in products designated for mass production, because the guaranteed number of rewritable times of the flash memory may be exceeded when this function is used, and product reliability therefore cannot be guaranteed. Renesas Electronics is not liable for problems occurring when the on-chip debug function is used.
  2. With products not provided with an  $EV_{DD0}$  or  $EV_{SS0}$  pin, replace  $EV_{DD0}$  with  $V_{DD}$ , or replace  $EV_{SS0}$  with  $V_{SS}$ .

## 2.1 Absolute Maximum Ratings

Absolute Maximum Ratings (T<sub>A</sub> = 25°C) (1/2)

Parameter	Symbols	Conditions	Ratings	Unit
Supply voltage	V <sub>DD</sub>		-0.5 to +6.5	V
	EV <sub>DD0</sub>		-0.5 to +6.5	V
	AV <sub>DD</sub>		-0.5 to +4.6	V
	AV <sub>REFP</sub>		-0.3 to AV <sub>DD</sub> + 0.3 <sup>Note 3</sup>	V
	EV <sub>SS0</sub>		-0.5 to +0.3	V
	AV <sub>SS</sub>		-0.5 to +0.3	V
	AV <sub>REFM</sub>		-0.3 to AV <sub>DD</sub> + 0.3 <sup>Note 3</sup> and AV <sub>REFM</sub> ≤ AV <sub>REFP</sub>	V
REGC pin input voltage	V <sub>IREGC</sub>	REGC	-0.3 to +2.8 and -0.3 to V <sub>DD</sub> + 0.3 <sup>Note 1</sup>	V
Input voltage	V <sub>I1</sub>	P00 to P06, P10 to P16, P30, P31, P40 to P43, P50, P51, P70 to P77, P120, P140, P141	-0.3 to EV <sub>DD0</sub> + 0.3 and -0.3 to V <sub>DD</sub> + 0.3 <sup>Note 2</sup>	V
	V <sub>I2</sub>	P60 to P63 (N-ch open-drain)	-0.3 to +6.5	V
	V <sub>I3</sub>	P121 to P124, P137, EXCLK, EXCLKS, $\overline{\text{RESET}}$	-0.3 to V <sub>DD</sub> + 0.3 <sup>Note 2</sup>	V
	V <sub>I4</sub>	P20 to P27, P150 to P154	-0.3 to AV <sub>DD</sub> + 0.3 <sup>Note 2</sup>	V
Output voltage	V <sub>O1</sub>	P00 to P06, P10 to P16, P30, P31, P40 to P43, P50, P51, P60 to P63, P70 to P77, P120, P130, P140, P141	-0.3 to EV <sub>DD0</sub> + 0.3 <sup>Note 2</sup>	V
	V <sub>O2</sub>	P20 to P27, P150 to P154	-0.3 to AV <sub>DD</sub> + 0.3 <sup>Note 2</sup>	V
Analog input voltage	V <sub>AI1</sub>	ANI16 to ANI30	-0.3 to EV <sub>DD0</sub> + 0.3 and -0.3 to AV <sub>REF(+)</sub> + 0.3 <sup>Notes 2, 4</sup>	V
	V <sub>AI2</sub>	ANI0 to ANI12	-0.3 to AV <sub>DD</sub> + 0.3 and -0.3 to AV <sub>REF(+)</sub> + 0.3 <sup>Notes 2, 4</sup>	V

**Notes 1.** Connect the REGC pin to V<sub>SS</sub> via a capacitor (0.47 to 1 μF). This value regulates the absolute maximum rating of the REGC pin. Do not use this pin with voltage applied to it.

**2.** Must be 6.5 V or lower.

**3.** Must be 4.6 V or lower.

**4.** Do not exceed AV<sub>REF(+)</sub> + 0.3 V in case of A/D conversion target pin.

**Caution** Product quality may suffer if the absolute maximum rating is exceeded even momentarily for any parameter. That is, the absolute maximum ratings are rated values at which the product is on the verge of suffering physical damage, and therefore the product must be used under conditions that ensure that the absolute maximum ratings are not exceeded.

**Remarks 1.** Unless specified otherwise, the characteristics of alternate-function pins are the same as those of the port pins.

**2.** AV<sub>REF(+)</sub>: + side reference voltage of the A/D converter.

**3.** V<sub>SS</sub>: Reference voltage

**Absolute Maximum Ratings ( $T_A = 25^\circ\text{C}$ ) (2/2)**

Parameter	Symbols	Conditions		Ratings	Unit
Output current, high	$I_{OH1}$	Per pin	P00 to P06, P10 to P16, P30, P31, P40 to P43, P50, P51, P70 to P77, P120, P130, P140, P141	-40	mA
		Total of all pins -170 mA	P00 to P04, P40 to P43, P120, P130, P140, P141	-70	mA
			P05, P06, P10 to P16, P30, P31, P50, P51, P70 to P77,	-100	mA
	$I_{OH2}$	Per pin	P20 to P27, P150 to P154	-0.1	mA
		Total of all pins		-1.3	mA
Output current, low	$I_{OL1}$	Per pin	P00 to P06, P10 to P16, P30, P31, P40 to P43, P50, P51, P60 to P63, P70 to P77, P120, P130, P140, P141	40	mA
		Total of all pins 170 mA	P00 to P04, P40 to P43, P120, P130, P140, P141	70	mA
			P05, P06, P10 to P16, P30, P31, P50, P51, P60 to P63, P70 to P77	100	mA
	$I_{OL2}$	Per pin	P20 to P27, P150 to P154	0.4	mA
		Total of all pins		6.4	mA
Operating ambient temperature	$T_A$	In normal operation mode		-40 to +85	$^\circ\text{C}$
		In flash memory programming mode			
Storage temperature	$T_{stg}$			-65 to +150	$^\circ\text{C}$

**Caution** Product quality may suffer if the absolute maximum rating is exceeded even momentarily for any parameter. That is, the absolute maximum ratings are rated values at which the product is on the verge of suffering physical damage, and therefore the product must be used under conditions that ensure that the absolute maximum ratings are not exceeded.

**Remark** Unless specified otherwise, the characteristics of alternate-function pins are the same as those of the port pins.

## 2.2 Oscillator Characteristics

### 2.2.1 X1, XT1 oscillator characteristics

(T<sub>A</sub> = -40 to +85°C, 1.6 V ≤ V<sub>DD</sub> ≤ 3.6 V, V<sub>SS</sub> = 0 V)

Parameter	Resonator	Conditions	MIN.	TYP.	MAX.	Unit
X1 clock oscillation frequency (f <sub>x</sub> ) <sup>Note</sup>	Ceramic resonator/crystal resonator	2.7 V ≤ V <sub>DD</sub> ≤ 3.6 V	1.0		20.0	MHz
		2.4 V ≤ V <sub>DD</sub> < 2.7 V	1.0		16.0	MHz
		1.8 V ≤ V <sub>DD</sub> < 2.4 V	1.0		8.0	MHz
		1.6 V ≤ V <sub>DD</sub> < 1.8 V	1.0		4.0	MHz
XT1 clock oscillation frequency (f <sub>x</sub> ) <sup>Note</sup>	Crystal resonator		32	32.768	35	kHz

**Note** Indicates only permissible oscillator frequency ranges. See AC Characteristics for instruction execution time. Request evaluation by the manufacturer of the oscillator circuit mounted on a board to check the oscillator characteristics.

<R> **Caution** Since the CPU is started by the high-speed on-chip oscillator clock after a reset release, check the X1 clock oscillation stabilization time using the oscillation stabilization time counter status register (OSTC) by the user. Determine the oscillation stabilization time of the OSTC register and the oscillation stabilization time select register (OSTS) after sufficiently evaluating the oscillation stabilization time with the resonator to be used.

### 2.2.2 On-chip oscillator characteristics

(T<sub>A</sub> = -40 to +85°C, 1.6 V ≤ V<sub>DD</sub> ≤ 3.6 V, V<sub>SS</sub> = 0 V)

Oscillators	Parameters	Conditions	MIN.	TYP.	MAX.	Unit	
High-speed on-chip oscillator clock frequency <sup>Notes 1, 2</sup>	f <sub>H</sub>		1		32	MHz	
High-speed on-chip oscillator clock frequency accuracy		-20 to +85 °C	1.8 V ≤ V <sub>DD</sub> ≤ 3.6 V	-1.0		+1.0	%
			1.6 V ≤ V <sub>DD</sub> < 1.8 V	-5.0		+5.0	%
		-40 to -20 °C	1.8 V ≤ V <sub>DD</sub> ≤ 3.6 V	-1.5		+1.5	%
			1.6 V ≤ V <sub>DD</sub> < 1.8 V	-5.5		+5.5	%
Low-speed on-chip oscillator clock frequency	f <sub>L</sub>			15		kHz	
Low-speed on-chip oscillator clock frequency accuracy			-15		+15	%	

**Notes 1.** High-speed on-chip oscillator frequency is selected by bits 0 to 3 of option byte (000C2H/010C2H) and bits 0 to 2 of HOCODIV register.

**2.** This indicates the oscillator characteristics only. See AC Characteristics for instruction execution time.

## 2.3 DC Characteristics

### 2.3.1 Pin characteristics

(T<sub>A</sub> = -40 to +85°C, 1.6 V ≤ AV<sub>DD</sub> ≤ V<sub>DD</sub> ≤ 3.6 V, 1.6 V ≤ EV<sub>DD0</sub> ≤ V<sub>DD</sub> ≤ 3.6 V, V<sub>SS</sub> = EV<sub>SS0</sub> = 0 V) (1/5)

Items	Symbol	Conditions	MIN.	TYP.	MAX.	Unit	
Output current, high <sup>Note 1</sup>	I <sub>OH1</sub>	Per pin for P00 to P06, P10 to P16, P30, P31, P40 to P43, P50, P51, P70 to P77, P120, P130, P140, P141	1.6 V ≤ EV <sub>DD0</sub> ≤ 3.6 V			-10.0 <sup>Note 2</sup>	mA
		Total of P00 to P04, P40 to P43, P120, P130, P140, P141 (When duty ≤ 70% <sup>Note 3</sup> )	2.7 V ≤ EV <sub>DD0</sub> ≤ 3.6 V			-10.0	mA
			1.8 V ≤ EV <sub>DD0</sub> < 2.7 V			-5.0	mA
			1.6 V ≤ EV <sub>DD0</sub> < 1.8 V			-2.5	mA
		Total of P05, P06, P10 to P16, P30, P31, P50, P51, P70 to P77, (When duty ≤ 70% <sup>Note 3</sup> )	2.7 V ≤ EV <sub>DD0</sub> ≤ 3.6 V			-19.0	mA
			1.8 V ≤ EV <sub>DD0</sub> < 2.7 V			-10.0	mA
			1.6 V ≤ EV <sub>DD0</sub> < 1.8 V			-5.0	mA
	Total of all pins (When duty ≤ 70% <sup>Note 3</sup> )	1.6 V ≤ EV <sub>DD0</sub> ≤ 3.6 V			-29.0	mA	
	I <sub>OH2</sub>	Per pin for P20 to P27, P150 to P154	1.6 V ≤ AV <sub>DD</sub> ≤ 3.6 V			-0.1 <sup>Note 2</sup>	mA
		Total of all pins (When duty ≤ 70% <sup>Note 3</sup> )	1.6 V ≤ AV <sub>DD</sub> ≤ 3.6 V			-1.3	mA

- Notes**
- Value of current at which the device operation is guaranteed even if the current flows from the EV<sub>DD0</sub>, V<sub>DD</sub> pins to an output pin.
  - However, do not exceed the total current value.
  - Specification under conditions where the duty factor ≤ 70%.

The output current value that has changed to the duty factor > 70% the duty ratio can be calculated with the following expression (when changing the duty factor from 70% to n%).

- Total output current of pins = (I<sub>OH</sub> × 0.7)/(n × 0.01)  
 <Example> Where n = 80% and I<sub>OH</sub> = -10.0 mA  
 Total output current of pins = (-10.0 × 0.7)/(80 × 0.01) ≅ -8.7 mA

However, the current that is allowed to flow into one pin does not vary depending on the duty factor. A current higher than the absolute maximum rating must not flow into one pin.

**Caution** P00, P02 to P04, P10 to P15, P43, P50, P71, and P74 do not output high level in N-ch open-drain mode.

**Remark** Unless specified otherwise, the characteristics of alternate-function pins are the same as those of the port pins.

(T<sub>A</sub> = -40 to +85°C, 1.6 V ≤ AV<sub>DD</sub> ≤ V<sub>DD</sub> ≤ 3.6 V, 1.6 V ≤ EV<sub>DD0</sub> ≤ V<sub>DD</sub> ≤ 3.6 V, V<sub>SS</sub> = EV<sub>SS0</sub> = 0 V) (2/5)

Items	Symbol	Conditions	MIN.	TYP.	MAX.	Unit	
Output current, I <sub>OL</sub> <sup>Note 1</sup>	I <sub>OL1</sub>	Per pin for P00 to P06, P10 to P16, P30, P31, P40 to P43, P50, P51, P70 to P77, P120, P130, P140, P141			20.0 <sup>Note 2</sup>	mA	
		Per pin for P60 to P63			15.0 <sup>Note 2</sup>	mA	
		Total of P00 to P04, P40 to P43, P120, P130, P140, P141 (When duty ≤ 70% <sup>Note 3</sup> )	2.7 V ≤ EV <sub>DD0</sub> ≤ 3.6 V			15.0	mA
			1.8 V ≤ EV <sub>DD0</sub> < 2.7 V			9.0	mA
			1.6 V ≤ EV <sub>DD0</sub> < 1.8 V			4.5	mA
		Total of P05, P06, P10 to P16, P30, P31, P50, P51, P60 to P63, P70 to P77 (When duty ≤ 70% <sup>Note 3</sup> )	2.7 V ≤ EV <sub>DD0</sub> ≤ 3.6 V			35.0	mA
			1.8 V ≤ EV <sub>DD0</sub> < 2.7 V			20.0	mA
	1.6 V ≤ EV <sub>DD0</sub> < 1.8 V				10.0	mA	
	Total of all pins (When duty ≤ 70% <sup>Note 3</sup> )				50.0	mA	
	I <sub>OL2</sub>	Per pin for P20 to P27, P150 to P154				0.4 <sup>Note 2</sup>	mA
Total of all pins (When duty ≤ 70% <sup>Note 3</sup> )		1.6 V ≤ AV <sub>DD</sub> ≤ 3.6 V			5.2	mA	

- Notes**
- Value of current at which the device operation is guaranteed even if the current flows from an output pin to the EV<sub>SS0</sub> and V<sub>SS</sub> pin.
  - However, do not exceed the total current value.
  - Specification under conditions where the duty factor ≤ 70%.

The output current value that has changed to the duty factor > 70% the duty ratio can be calculated with the following expression (when changing the duty factor from 70% to n%).

- Total output current of pins = (I<sub>OL</sub> × 0.7)/(n × 0.01)
- <Example> Where n = 80% and I<sub>OL</sub> = 10.0 mA
- $$\text{Total output current of pins} = (10.0 \times 0.7)/(80 \times 0.01) \cong 8.7 \text{ mA}$$

However, the current that is allowed to flow into one pin does not vary depending on the duty factor. A current higher than the absolute maximum rating must not flow into one pin.

**Remark** Unless specified otherwise, the characteristics of alternate-function pins are the same as those of the port pins.

(T<sub>A</sub> = -40 to +85°C, 1.6 V ≤ AV<sub>DD</sub> ≤ V<sub>DD</sub> ≤ 3.6 V, 1.6 V ≤ EV<sub>DD0</sub> ≤ V<sub>DD</sub> ≤ 3.6 V, V<sub>SS</sub> = EV<sub>SS0</sub> = 0 V) (3/5)

Items	Symbol	Conditions	MIN.	TYP.	MAX.	Unit	
Input voltage, high	V <sub>IH1</sub>	P00 to P06, P10 to P16, P30, P31, P40 to P43, P50, P51, P70 to P77, P120, P140, P141	Normal input buffer	0.8EV <sub>DD0</sub>		EV <sub>DD0</sub>	V
	V <sub>IH2</sub>	P01, P03, P04, P10, P11, P13 to P16, P43	TTL input buffer 3.3 V ≤ EV <sub>DD0</sub> ≤ 3.6 V	2.0		EV <sub>DD0</sub>	V
			TTL input buffer 1.6 V ≤ EV <sub>DD0</sub> < 3.3 V	1.5		EV <sub>DD0</sub>	V
	V <sub>IH3</sub>	P20 to P27, P150 to P154		0.7AV <sub>DD</sub>		AV <sub>DD</sub>	V
	V <sub>IH4</sub>	P60 to P63		0.7EV <sub>DD0</sub>		6.0	V
	V <sub>IH5</sub>	P121 to P124, P137, EXCLK, EXCLKS, RESET		0.8V <sub>DD</sub>		V <sub>DD</sub>	V
Input voltage, low	V <sub>IL1</sub>	P00 to P06, P10 to P16, P30, P31, P40 to P43, P50, P51, P70 to P77, P120, P140, P141	Normal input buffer	0		0.2EV <sub>DD0</sub>	V
	V <sub>IL2</sub>	P01, P03, P04, P10, P11, P13 to P16, P43	TTL input buffer 3.3 V ≤ EV <sub>DD0</sub> ≤ 3.6 V	0		0.5	V
			TTL input buffer 1.6 V ≤ EV <sub>DD0</sub> < 3.3 V	0		0.32	V
	V <sub>IL3</sub>	P20 to P27, P150 to P154		0		0.3AV <sub>DD</sub>	V
	V <sub>IL4</sub>	P60 to P63		0		0.3EV <sub>DD0</sub>	V
	V <sub>IL5</sub>	P121 to P124, P137, EXCLK, EXCLKS, RESET		0		0.2V <sub>DD</sub>	V

**Caution** The maximum value of V<sub>IH</sub> of pins P00, P02 to P04, P10 to P15, P43, P50, P71, and P74 is EV<sub>DD0</sub>, even in the N-ch open-drain mode.

**Remark** Unless specified otherwise, the characteristics of alternate-function pins are the same as those of the port pins.



(T<sub>A</sub> = -40 to +85°C, 1.6 V ≤ AV<sub>DD</sub> ≤ V<sub>DD</sub> ≤ 3.6 V, 1.6 V ≤ EV<sub>DD0</sub> ≤ V<sub>DD</sub> ≤ 3.6 V, V<sub>SS</sub> = EV<sub>SS0</sub> = 0 V) (4/5)

Items	Symbol	Conditions	MIN.	TYP.	MAX.	Unit
Output voltage, high	V <sub>OH1</sub>	P00 to P06, P10 to P16, P30, P31, P40 to P43, P50, P51, P70 to P77, P120, P130, P140, P141	2.7 V ≤ EV <sub>DD0</sub> ≤ 3.6 V, I <sub>OH1</sub> = -2.0 mA	EV <sub>DD0</sub> - 0.6		V
			1.8 V ≤ EV <sub>DD0</sub> ≤ 3.6 V, I <sub>OH1</sub> = -1.5 mA	EV <sub>DD0</sub> - 0.5		V
			1.6 V ≤ EV <sub>DD0</sub> ≤ 3.6 V, I <sub>OH1</sub> = -1.0 mA	EV <sub>DD0</sub> - 0.5		V
	V <sub>OH2</sub>	P20 to P27, P150 to P154	1.6 V ≤ AV <sub>DD</sub> ≤ 3.6 V, I <sub>OH2</sub> = -100 μA	AV <sub>DD</sub> - 0.5		V
Output voltage, low	V <sub>OL1</sub>	P00 to P06, P10 to P16, P30, P31, P40 to P43, P50, P51, P70 to P77, P120, P130, P140, P141	2.7 V ≤ EV <sub>DD0</sub> ≤ 3.6 V, I <sub>OL1</sub> = 3.0 mA		0.6	V
			2.7 V ≤ EV <sub>DD0</sub> ≤ 3.6 V, I <sub>OL1</sub> = 1.5 mA		0.4	V
			1.8 V ≤ EV <sub>DD0</sub> ≤ 3.6 V, I <sub>OL1</sub> = 0.6 mA		0.4	V
			1.6 V ≤ EV <sub>DD0</sub> < 1.8 V, I <sub>OL1</sub> = 0.3 mA		0.4	V
	V <sub>OL2</sub>	P20 to P27, P150 to P154	1.6 V ≤ AV <sub>DD</sub> ≤ 3.6 V, I <sub>OL2</sub> = 400 μA		0.4	V
	V <sub>OL3</sub>	P60 to P63	2.7 V ≤ EV <sub>DD0</sub> ≤ 3.6 V, I <sub>OL3</sub> = 3.0 mA		0.4	V
			1.8 V ≤ EV <sub>DD0</sub> ≤ 3.6 V, I <sub>OL3</sub> = 2.0 mA		0.4	V
1.6 V ≤ EV <sub>DD0</sub> < 1.8 V, I <sub>OL3</sub> = 1.0 mA				0.4	V	

**Caution** P00, P02 to P04, P10 to P15, P43, P50, P71, and P74 do not output high level in N-ch open-drain mode.

**Remark** Unless specified otherwise, the characteristics of alternate-function pins are the same as those of the port pins.

**( $T_A = -40$  to  $+85^\circ\text{C}$ ,  $1.6\text{ V} \leq AV_{DD} \leq V_{DD} \leq 3.6\text{ V}$ ,  $1.6\text{ V} \leq EV_{DD0} \leq V_{DD} \leq 3.6\text{ V}$ ,  $V_{SS} = EV_{SS0} = 0\text{ V}$ ) (5/5)**

Items	Symbol	Conditions	MIN.	TYP.	MAX.	Unit		
Input leakage current, high	$I_{LIH1}$	P00 to P06, P10 to P16, P30, P31, P40 to P43, P50, P51, P60 to P63, P70 to P77, P120, P140, P141	$V_I = EV_{DD0}$		1	$\mu\text{A}$		
	$I_{LIH2}$	P137, $\overline{\text{RESET}}$	$V_I = V_{DD}$		1	$\mu\text{A}$		
	$I_{LIH3}$	P121 to P124 (X1, X2, XT1, XT2, EXCLK, EXCLKS)	$V_I = V_{DD}$	In input port or external clock input	1	$\mu\text{A}$		
				In resonator connection	10	$\mu\text{A}$		
$I_{LIH4}$	P20 to P27, P150 to P154	$V_I = AV_{DD}$		1	$\mu\text{A}$			
Input leakage current, low	$I_{LIL1}$	P00 to P06, P10 to P16, P30, P31, P40 to P43, P50, P51, P60 to P67, P70 to P77, P120, P140, P141	$V_I = EV_{SS0}$		-1	$\mu\text{A}$		
	$I_{LIL2}$	P137, $\overline{\text{RESET}}$	$V_I = V_{SS}$		-1	$\mu\text{A}$		
	$I_{LIL3}$	P121 to P124 (X1, X2, XT1, XT2, EXCLK, EXCLKS)	$V_I = V_{SS}$	In input port or external clock input	-1	$\mu\text{A}$		
				In resonator connection	-10	$\mu\text{A}$		
$I_{LIL4}$	P20 to P27, P150 to P154	$V_I = AV_{SS}$		-1	$\mu\text{A}$			
On-chip pull-up resistance	$R_U$	P00 to P06, P10 to P16, P30, P31, P40 to P43, P50, P51, P70 to P77, P120, P140, P141	$V_I = EV_{SS0}$ , In input port		10	20	100	$\text{k}\Omega$

**Remark** Unless specified otherwise, the characteristics of alternate-function pins are the same as those of the port pins.

## 2.3.2 Supply current characteristics

(T<sub>A</sub> = -40 to +85°C, 1.6 V ≤ E<sub>VDD0</sub> ≤ V<sub>DD</sub> ≤ 3.6 V, V<sub>SS</sub> = E<sub>VSS0</sub> = 0 V)

(1/3)

Parameter	Symbol	Conditions			MIN.	TYP.	MAX.	Unit			
Supply current <sup>Note 1</sup>	I <sub>DD1</sub>	Operating mode	HS (high-speed main) mode <sup>Note 5</sup>	f <sub>IH</sub> = 32 MHz <sup>Note 3</sup>	Basic operation	V <sub>DD</sub> = 3.0 V		2.1		mA	
					Normal operation	V <sub>DD</sub> = 3.0 V		4.6	7.0	mA	
				Normal operation	V <sub>DD</sub> = 3.0 V	f <sub>IH</sub> = 24 MHz <sup>Note 3</sup>		3.7	5.5	mA	
						f <sub>IH</sub> = 16 MHz <sup>Note 3</sup>		2.7	4.0	mA	
			LS (low-speed main) mode <sup>Note 5</sup>	f <sub>IH</sub> = 8 MHz <sup>Note 3</sup>	Normal operation	V <sub>DD</sub> = 3.0 V		1.2	1.8	mA	
							V <sub>DD</sub> = 2.0 V		1.2		1.8
			LV (Low-voltage main) mode <sup>Note 5</sup>	f <sub>IH</sub> = 4 MHz <sup>Note 3</sup>	Normal operation	V <sub>DD</sub> = 3.0 V		1.2	1.7	mA	
						V <sub>DD</sub> = 2.0 V		1.2	1.7		
			HS (high-speed main) mode <sup>Note 5</sup>	f <sub>MX</sub> = 20 MHz <sup>Note 2</sup> , V <sub>DD</sub> = 3.0 V	Normal operation	Square wave input		3.0	4.6	mA	
						Resonator connection		3.2	4.8		
					Normal operation	Square wave input	V <sub>DD</sub> = 3.0 V		1.9	2.7	mA
							V <sub>DD</sub> = 2.0 V		1.9	2.7	
			LS (low-speed main) mode <sup>Note 5</sup>	f <sub>MX</sub> = 8 MHz <sup>Note 2</sup> , V <sub>DD</sub> = 3.0 V	Normal operation	Square wave input		1.1	1.7	mA	
						Resonator connection		1.1	1.7		
				Normal operation	Square wave input	V <sub>DD</sub> = 3.0 V		1.1	1.7	mA	
						V <sub>DD</sub> = 2.0 V		1.1	1.7		
			Subsystem clock mode	f <sub>SUB</sub> = 32.768 kHz <sup>Note 4</sup>	Normal operation	Square wave input	T <sub>A</sub> = -40°C		4.1	4.9	μA
							Resonator connection		4.2	5.0	
					Normal operation	Square wave input	T <sub>A</sub> = +25°C		4.2	4.9	μA
							Resonator connection		4.3	5.0	
Normal operation	Square wave input	T <sub>A</sub> = +50°C				4.3	5.5	μA			
		Resonator connection				4.4	5.6				
Normal operation	Square wave input	T <sub>A</sub> = +70°C				4.5	6.3	μA			
		Resonator connection				4.6	6.4				
Normal operation	Square wave input	T <sub>A</sub> = +85°C				4.8	7.7	μA			
		Resonator connection				4.9	7.8				

(Notes and Remarks are listed on the next page.)

- Notes**
1. Total current flowing into  $V_{DD}$  and  $EV_{DD0}$ , including the input leakage current flowing when the level of the input pin is fixed to  $V_{DD}$ ,  $EV_{DD0}$  or  $V_{SS}$ ,  $EV_{SS0}$ . The values below the MAX. column include the peripheral operation current. However, not including the current flowing into the A/D converter, LVD circuit, I/O port, on-chip pull-up/pull-down resistors, and data flash rewriting.
  2. When high-speed on-chip oscillator and subsystem clock are stopped.
  3. When high-speed system clock and subsystem clock are stopped.
  4. When high-speed on-chip oscillator and high-speed system clock are stopped. When setting ultra-low power consumption oscillation ( $AMPHS1 = 1$ ). Not including the current flowing into the RTC, 12-bit interval timer and watchdog timer
  5. Relationship between operation voltage width, operation frequency of CPU and operation mode is as below.
    - HS (high-speed main) mode:  $V_{DD} = 2.7\text{ V to }3.6\text{ V}@1\text{ MHz to }32\text{ MHz}$   
 $V_{DD} = 2.4\text{ V to }3.6\text{ V}@1\text{ MHz to }16\text{ MHz}$
    - LS (low-speed main) mode:  $V_{DD} = 1.8\text{ V to }3.6\text{ V}@1\text{ MHz to }8\text{ MHz}$
    - LV (Low-voltage main) mode:  $V_{DD} = 1.6\text{ V to }3.6\text{ V}@1\text{ MHz to }4\text{ MHz}$

- Remarks**
1.  $f_{MX}$ : High-speed system clock frequency (X1 clock oscillation frequency or external main system clock frequency)
  2.  $f_{IH}$ : High-speed on-chip oscillator clock frequency
  3.  $f_{SUB}$ : Subsystem clock frequency (XT1 clock oscillation frequency)
  4. Except subsystem clock operation, temperature condition of the TYP. value is  $T_A = 25^\circ\text{C}$

(T<sub>A</sub> = -40 to +85°C, 1.6 V ≤ EV<sub>DD0</sub> ≤ V<sub>DD</sub> ≤ 3.6 V, V<sub>SS</sub> = EV<sub>SS0</sub> = 0 V) (2/3)

Parameter	Symbol	Conditions			MIN.	TYP.	MAX.	Unit			
Supply current <sup>Note 1</sup>	I <sub>DD2</sub> <sup>Note 2</sup>	HALT mode	HS (high-speed main) mode <sup>Note 7</sup>	f <sub>IH</sub> = 32 MHz <sup>Note 4</sup>	V <sub>DD</sub> = 3.0 V		0.54	1.63	mA		
				f <sub>IH</sub> = 24 MHz <sup>Note 4</sup>	V <sub>DD</sub> = 3.0 V		0.44	1.28	mA		
				f <sub>IH</sub> = 16 MHz <sup>Note 4</sup>	V <sub>DD</sub> = 3.0 V		0.40	1.00	mA		
			LS (low-speed main) mode <sup>Note 7</sup>	f <sub>IH</sub> = 8 MHz <sup>Note 4</sup>	V <sub>DD</sub> = 3.0 V		270	530	μA		
					V <sub>DD</sub> = 2.0 V		270	530			
			LV (Low-voltage main) mode <sup>Note 7</sup>	f <sub>IH</sub> = 4 MHz <sup>Note 4</sup>	V <sub>DD</sub> = 3.0 V		435	640	μA		
					V <sub>DD</sub> = 2.0 V		435	640			
			HS (high-speed main) mode <sup>Note 7</sup>	f <sub>MX</sub> = 20 MHz <sup>Note 3</sup> , V <sub>DD</sub> = 3.0 V	Square wave input		0.28	1.00	mA		
					Resonator connection		0.45	1.17			
				f <sub>MX</sub> = 10 MHz <sup>Note 3</sup> , V <sub>DD</sub> = 3.0 V	Square wave input		0.19	0.60	mA		
					Resonator connection		0.26	0.67			
			LS (low-speed main) mode <sup>Note 7</sup>	f <sub>MX</sub> = 8 MHz <sup>Note 3</sup> , V <sub>DD</sub> = 3.0 V	Square wave input		95	330	μA		
					Resonator connection		145	380			
				f <sub>MX</sub> = 8 MHz <sup>Note 3</sup> , V <sub>DD</sub> = 2.0 V	Square wave input		95	330	μA		
					Resonator connection		145	380			
			Subsystem clock mode	f <sub>SUB</sub> = 32.768 kHz <sup>Note 5</sup> T <sub>A</sub> = -40°C	Square wave input		0.25	0.57	μA		
					Resonator connection		0.44	0.76			
				f <sub>SUB</sub> = 32.768 kHz <sup>Note 5</sup> T <sub>A</sub> = +25°C	Square wave input		0.30	0.57	μA		
					Resonator connection		0.49	0.76			
				f <sub>SUB</sub> = 32.768 kHz <sup>Note 5</sup> T <sub>A</sub> = +50°C	Square wave input		0.38	1.17	μA		
					Resonator connection		0.57	1.36			
				f <sub>SUB</sub> = 32.768 kHz <sup>Note 5</sup> T <sub>A</sub> = +70°C	Square wave input		0.52	1.97	μA		
					Resonator connection		0.71	2.16			
			f <sub>SUB</sub> = 32.768 kHz <sup>Note 5</sup> T <sub>A</sub> = +85°C	Square wave input		0.97	3.37	μA			
				Resonator connection		1.16	3.56				
			I <sub>DD3</sub> <sup>Note 6</sup>	STOP mode <sup>Note 8</sup>	T <sub>A</sub> = -40°C				0.16	0.50	μA
					T <sub>A</sub> = +25°C				0.23	0.50	
T <sub>A</sub> = +50°C						0.34	1.10				
T <sub>A</sub> = +70°C						0.46	1.90				
T <sub>A</sub> = +85°C						0.75	3.30				

(Notes and Remarks are listed on the next page.)

- Notes**
1. Total current flowing into  $V_{DD}$  and  $EV_{DD0}$ , including the input leakage current flowing when the level of the input pin is fixed to  $V_{DD}$ ,  $EV_{DD0}$  or  $V_{SS}$ ,  $EV_{SS0}$ . The values below the MAX. column include the peripheral operation current. However, not including the current flowing into the A/D converter, LVD circuit, I/O port, on-chip pull-up/pull-down resistors, and data flash rewriting.
  2. During HALT instruction execution by flash memory.
  3. When high-speed on-chip oscillator and subsystem clock are stopped.
  4. When high-speed system clock and subsystem clock are stopped.
  5. When high-speed on-chip oscillator and high-speed system clock are stopped. When  $RTCLPC = 1$  and setting ultra-low current consumption ( $AMPHS1 = 1$ ). Including the current flowing into the RTC. However, not including the current flowing into the 12-bit interval timer, and watchdog timer.
  6. When subsystem clock is stopped. Not including the current flowing into the RTC, 12-bit interval timer, watchdog timer.
  7. Relationship between operation voltage width, operation frequency of CPU and operation mode is as below.
    - HS (high-speed main) mode:  $2.7\text{ V} \leq V_{DD} \leq 3.6\text{ V}@1\text{ MHz to }32\text{ MHz}$   
 $2.4\text{ V} \leq V_{DD} \leq 3.6\text{ V}@1\text{ MHz to }16\text{ MHz}$
    - LS (low-speed main) mode:  $1.8\text{ V} \leq V_{DD} < 3.6\text{ V}@1\text{ MHz to }8\text{ MHz}$
    - LV (low-voltage main) mode:  $1.6\text{ V} \leq V_{DD} \leq 3.6\text{ V}@1\text{ MHz to }4\text{ MHz}$
  8. Regarding the value for current to operate the subsystem clock in STOP mode, refer to that in HALT mode.

- Remarks**
1.  $f_{MX}$ : High-speed system clock frequency (X1 clock oscillation frequency or external main system clock frequency)
  2.  $f_{IH}$ : High-speed on-chip oscillator clock frequency
  3.  $f_{SUB}$ : Subsystem clock frequency (XT1 clock oscillation frequency)
  4. Except subsystem clock operation and STOP mode, temperature condition of the TYP. value is  $T_A = 25^\circ\text{C}$

<R> (T<sub>A</sub> = -40 to +85°C, 1.6 V ≤ EV<sub>DD0</sub> ≤ V<sub>DD</sub> ≤ 3.6 V, V<sub>SS</sub> = EV<sub>SS0</sub> = 0 V) (3/3)

Parameter	Symbol	Conditions	MIN.	TYP.	MAX.	Unit
Low-speed on-chip oscillator operating current	I <sub>FIL</sub> <sup>Note 1</sup>			0.20		μA
RTC operating current	I <sub>RTC</sub> <sup>Notes 1, 2, 3</sup>			0.02		μA
12-bit interval timer operating current	I <sub>IT</sub> <sup>Notes 1, 2, 4</sup>			0.02		μA
Watchdog timer operating current	I <sub>WDT</sub> <sup>Notes 1, 2, 5</sup>	f <sub>IL</sub> = 15 kHz		0.22		μA
A/D converter operating current	I <sub>ADC</sub> <sup>Notes 6, 7</sup>	AV <sub>DD</sub> = 3.0 V, When conversion at maximum speed		420	720	μA
AV <sub>REF(+)</sub> current	I <sub>AVREF</sub> <sup>Note 8</sup>	AV <sub>DD</sub> = 3.0 V, ADREFP1 = 0, ADREFP0 = 0 <sup>Note 7</sup>		14.0	25.0	μA
		AV <sub>REFP</sub> = 3.0 V, ADREFP1 = 0, ADREFP0 = 1 <sup>Note 10</sup>		14.0	25.0	μA
		ADREFP1 = 1, ADREFP0 = 0 <sup>Note 1</sup>		14.0	25.0	μA
A/D converter reference voltage current	I <sub>ADREF</sub> <sup>Notes 1, 9</sup>	V <sub>DD</sub> = 3.0 V		75.0		μA
Temperature sensor operating current	I <sub>TMP</sub> <sup>Note 1</sup>	V <sub>DD</sub> = 3.0 V		75.0		μA
LVD operating current	I <sub>LVD</sub> <sup>Notes 1, 11</sup>			0.08		μA
BGO operating current	I <sub>BGO</sub> <sup>Notes 1, 12</sup>			2.5	12.2	mA
Self-programming operating current	I <sub>FSP</sub> <sup>Notes 1, 13</sup>			2.5	12.2	mA
SNOOZE operating current	I <sub>SNOZ</sub>	A/D converter operation (AV <sub>DD</sub> = 3.0 V)	The mode is performed <sup>Notes 1, 14</sup>	0.50	0.60	mA
			During A/D conversion <sup>Note 1</sup>	0.60	0.75	mA
			During A/D conversion <sup>Note 7</sup>	420	720	μA
		CSI/UART operation <sup>Note 1</sup>	0.70	0.84	mA	

(Notes and Remarks are listed on the next page.)

- <R> **Notes**
1. Current flowing to V<sub>DD</sub>.
  2. When high-speed on-chip oscillator and high-speed system clock are stopped.
  3. Current flowing only to the real-time clock (RTC) (excluding the operating current of the low-speed on-chip oscillator and the XT1 oscillator). The supply current of the RL78 microcontrollers is the sum of the values of either I<sub>DD1</sub> or I<sub>DD2</sub>, and I<sub>RTC</sub>, when the real-time clock operates in operation mode or HALT mode. When the low-speed on-chip oscillator is selected, I<sub>FIL</sub> should be added. I<sub>DD2</sub> subsystem clock operation includes the operational current of the real-time clock.
  4. Current flowing only to the 12-bit interval timer (excluding the operating current of the low-speed on-chip oscillator and the XT1 oscillator). The supply current of the RL78 microcontrollers is the sum of the values of either I<sub>DD1</sub> or I<sub>DD2</sub>, and I<sub>IT</sub>, when the 12-bit interval timer operates in operation mode or HALT mode. When the low-speed on-chip oscillator is selected, I<sub>FIL</sub> should be added.
  5. Current flowing only to the watchdog timer (including the operating current of the low-speed on-chip oscillator). The supply current of the RL78 microcontrollers is the sum of I<sub>DD1</sub>, I<sub>DD2</sub>, or I<sub>DD3</sub> and I<sub>WDT</sub> when the watchdog timer is in operation.
  6. Current flowing only to the A/D converter. The supply current of the RL78 microcontrollers is the sum of I<sub>DD1</sub> or I<sub>DD2</sub> and I<sub>ADC</sub>, I<sub>AVREF</sub>, I<sub>ADREF</sub> when the A/D converter operates in an operation mode or the HALT mode.
  7. Current flowing to the AV<sub>DD</sub>.
  8. Current flowing from the reference voltage source of A/D converter.
  9. Operation current flowing to the internal reference voltage.
  10. Current flowing to the AV<sub>REFP</sub>.
  11. Current flowing only to the LVD circuit. The supply current of the RL78 microcontrollers is the sum of I<sub>DD1</sub>, I<sub>DD2</sub> or I<sub>DD3</sub> and I<sub>LVD</sub> when the LVD circuit is in operation.
  12. Current flowing only during data flash rewrite.
  13. Current flowing only during self programming.

- Remarks**
1. f<sub>IL</sub>: Low-speed on-chip oscillator clock frequency
  2. f<sub>SUB</sub>: Subsystem clock frequency (XT1 clock oscillation frequency)
  3. f<sub>CLK</sub>: CPU/peripheral hardware clock frequency
  4. Temperature condition of the TYP. value is T<sub>A</sub> = 25°C



## 2.4 AC Characteristics

(T<sub>A</sub> = -40 to +85°C, AV<sub>DD</sub> ≤ V<sub>DD</sub> ≤ 3.6 V, 1.6 V ≤ EV<sub>DD0</sub> ≤ V<sub>DD</sub> ≤ 3.6 V, V<sub>SS</sub> = EV<sub>SS0</sub> = 0 V)

Items	Symbol	Conditions		MIN.	TYP.	MAX.	Unit	
Instruction cycle (minimum instruction execution time)	T <sub>cy</sub>	Main system clock (f <sub>MAIN</sub> ) operation	HS (high-speed main) mode	2.7 V ≤ V <sub>DD</sub> ≤ 3.6 V	0.03125	1	μs	
				2.4 V ≤ V <sub>DD</sub> < 2.7 V	0.0625	1	μs	
			LS (low-speed main) mode	1.8 V ≤ V <sub>DD</sub> ≤ 3.6 V	0.125	1	μs	
				1.6 V ≤ V <sub>DD</sub> ≤ 3.6 V	0.25	1	μs	
		Subsystem clock (f <sub>SUB</sub> ) operation		1.8 V ≤ V <sub>DD</sub> ≤ 3.6 V	28.5	30.5	31.3	μs
		In the self programming mode	HS (high-speed main) mode	2.7 V ≤ V <sub>DD</sub> ≤ 3.6 V	0.03125	1	μs	
				2.4 V ≤ V <sub>DD</sub> < 2.7 V	0.0625	1	μs	
			LS (low-speed main) mode	1.8 V ≤ V <sub>DD</sub> ≤ 3.6 V	0.125	1	μs	
1.6 V ≤ V <sub>DD</sub> ≤ 3.6 V	0.25			1	μs			
External system clock frequency	f <sub>EX</sub>	2.7 V ≤ V <sub>DD</sub> ≤ 3.6 V		1.0		20.0	MHz	
		2.4 V ≤ V <sub>DD</sub> < 2.7 V		1.0		16.0	MHz	
		1.8 V ≤ V <sub>DD</sub> < 2.4 V		1.0		8.0	MHz	
		1.6 V ≤ V <sub>DD</sub> < 1.8 V		1.0		4.0	MHz	
	f <sub>EXS</sub>			32		35	kHz	
External system clock input high-level width, low-level width	t <sub>EXH</sub> , t <sub>EXL</sub>	2.7 V ≤ V <sub>DD</sub> ≤ 3.6 V		24			ns	
		2.4 V ≤ V <sub>DD</sub> < 2.7 V		30			ns	
		1.8 V ≤ V <sub>DD</sub> < 2.4 V		60			ns	
		1.6 V ≤ V <sub>DD</sub> < 1.8 V		120			ns	
	t <sub>EXHS</sub> , t <sub>EXLS</sub>			13.7			μs	
Ti00, Ti01, Ti03 to Ti07 input high-level width, low-level width	t <sub>TIH</sub> , t <sub>TIL</sub>			1/f <sub>MCK</sub> +10			ns <sup>Note</sup>	
TO00, TO01, TO03 to TO07 output frequency	f <sub>TO</sub>	HS (high-speed main) mode	2.7 V ≤ EV <sub>DD0</sub> ≤ 3.6 V			8	MHz	
			1.8 V ≤ EV <sub>DD0</sub> < 2.7 V			4	MHz	
			1.6 V ≤ EV <sub>DD0</sub> < 1.8 V			2	MHz	
		LS (low-speed main) mode	1.8 V ≤ EV <sub>DD0</sub> ≤ 3.6 V			4	MHz	
			1.6 V ≤ EV <sub>DD0</sub> < 1.8 V			2	MHz	
		LV (low-voltage main) mode	1.6 V ≤ EV <sub>DD0</sub> ≤ 3.6 V			2	MHz	
PCLBUZ0, PCLBUZ1 output frequency	f <sub>PCL</sub>	HS (high-speed main) mode	2.7 V ≤ EV <sub>DD0</sub> ≤ 3.6 V			8	MHz	
			1.8 V ≤ EV <sub>DD0</sub> < 2.7 V			4	MHz	
			1.6 V ≤ EV <sub>DD0</sub> < 1.8 V			2	MHz	
		LS (low-speed main) mode	1.8 V ≤ EV <sub>DD0</sub> ≤ 3.6 V			4	MHz	
			1.6 V ≤ EV <sub>DD0</sub> < 1.8 V			2	MHz	
		LV (low-voltage main) mode	1.8 V ≤ EV <sub>DD0</sub> ≤ 3.6 V			4	MHz	
		1.6 V ≤ EV <sub>DD0</sub> < 1.8 V			2	MHz		
Interrupt input high-level width, low-level width	t <sub>INTH</sub> , t <sub>INTL</sub>	INTP0	1.6 V ≤ V <sub>DD</sub> ≤ 3.6 V	1			μs	
		INTP1 to INTP11	1.6 V ≤ EV <sub>DD0</sub> ≤ 3.6 V	1			μs	
Key interrupt input high-level width, low-level width	t <sub>KR</sub>	KR0 to KR9	1.8 V ≤ EV <sub>DD0</sub> ≤ 3.6 V, 1.8 V ≤ AV <sub>DD0</sub> ≤ 3.6 V	250			ns	
			1.6 V ≤ EV <sub>DD0</sub> < 1.8 V, 1.6 V ≤ AV <sub>DD0</sub> < 1.8 V	1			μs	
RESET low-level width	t <sub>RSL</sub>			10			μs	

(Note and Remark are listed on the next page.)

**Note** The following conditions are required for low-voltage interface when EV<sub>DD0</sub> < V<sub>DD</sub>.

1.8 V ≤ EV<sub>DD0</sub> < 2.7 V : MIN. 125 ns

1.6 V ≤ EV<sub>DD0</sub> < 1.8 V : MIN. 250 ns

**Remark** f<sub>MCK</sub>: Timer array unit operation clock frequency

(Operation clock to be set by the CKS0n bit of timer clock select register 0 (TPS0) and timer mode register 0n (TMR0n). n: Channel number (n = 0 to 7))

**Minimum Instruction Execution Time during Main System Clock Operation**

<R>

T<sub>CY</sub> vs V<sub>DD</sub> (HS (high-speed main) mode)

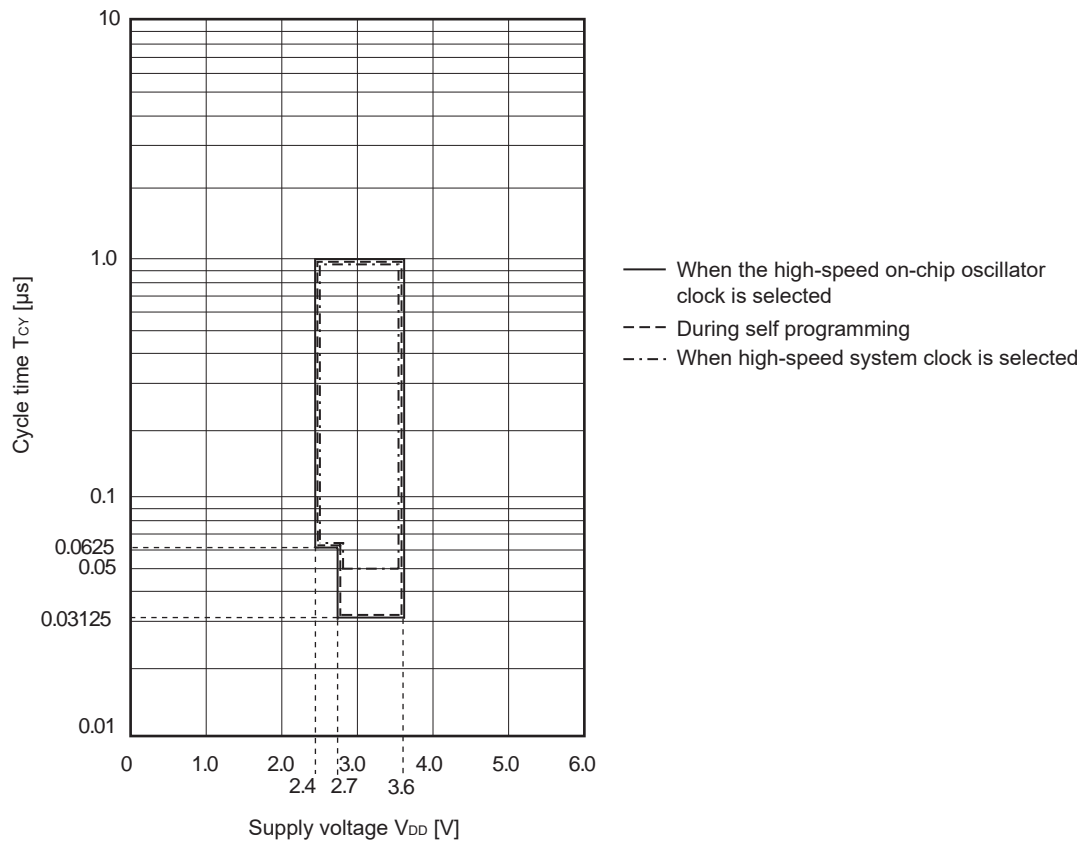

<R>

T<sub>CY</sub> vs V<sub>DD</sub> (LS (low-speed main) mode)

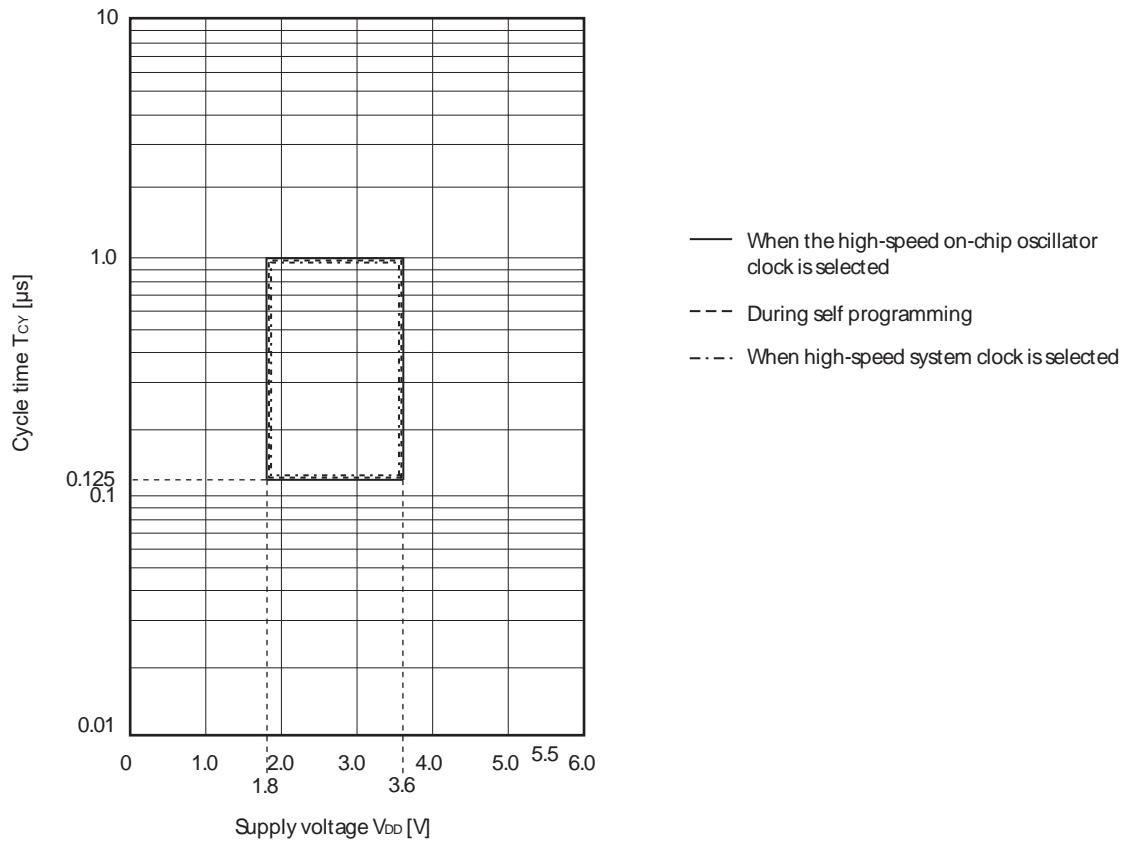

<R>

T<sub>CY</sub> vs V<sub>DD</sub> (LV (low-voltage main) mode)

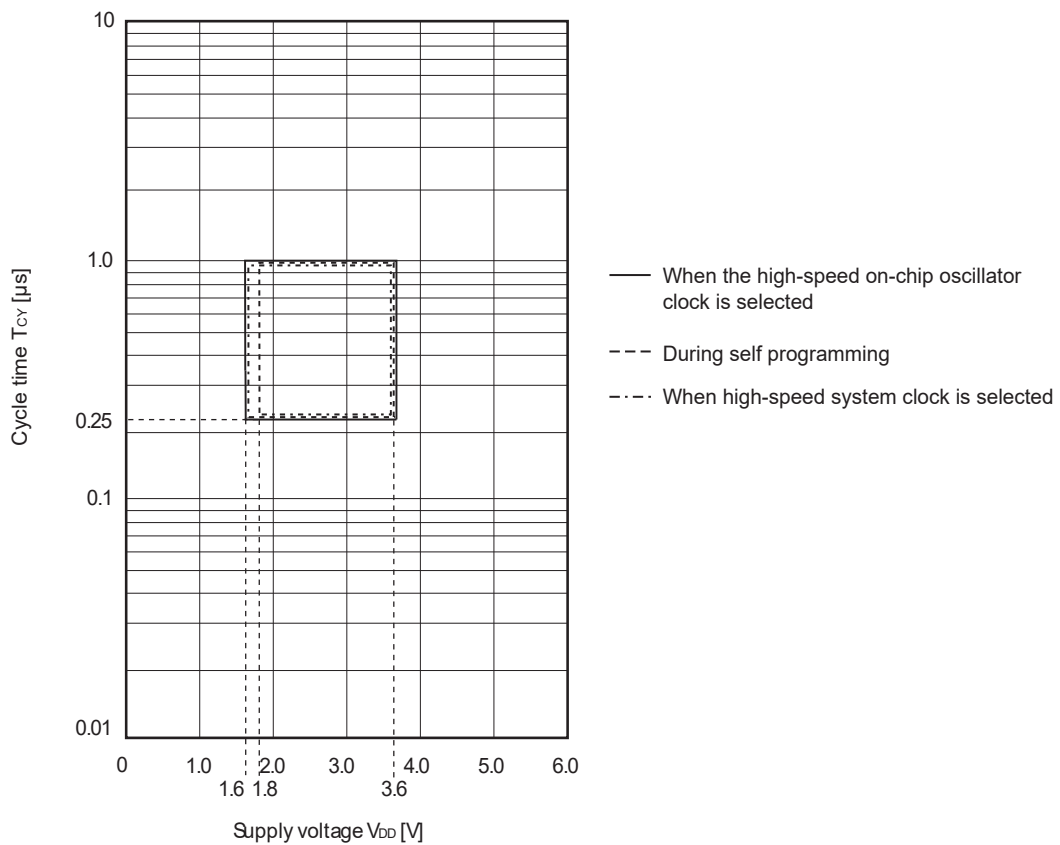

**AC Timing Test Points**

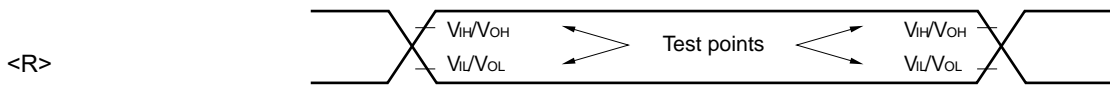

**External System Clock Timing**

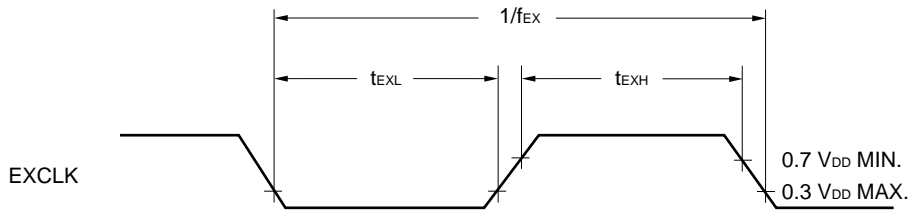

<R> **TI/TO Timing**

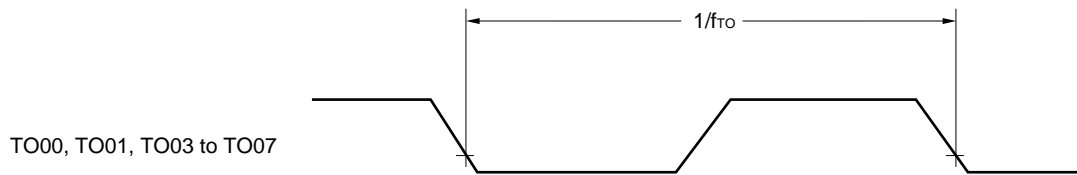
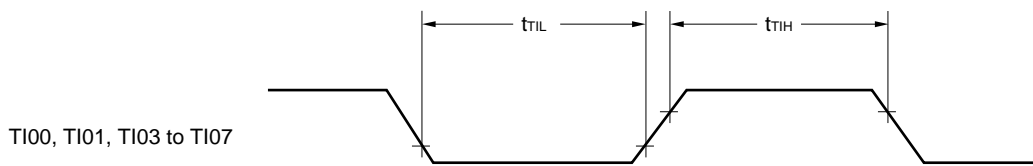

**Interrupt Request Input Timing**

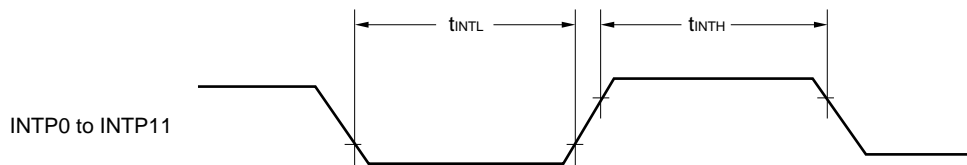

**Key Interrupt Input Timing**

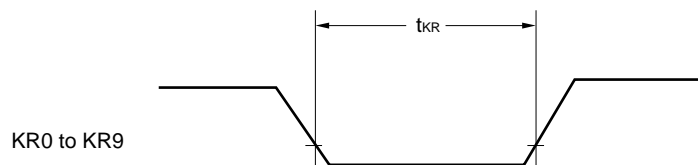

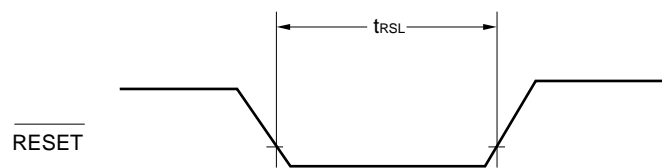
**$\overline{\text{RESET}}$  Input Timing**

## 2.5 Peripheral Functions Characteristics

### AC Timing Test Points

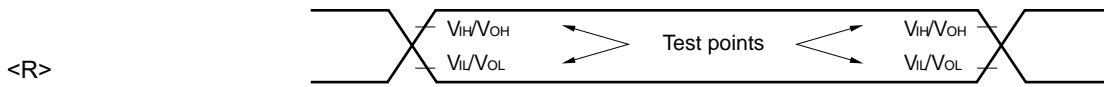

### 2.5.1 Serial array unit

#### (1) During communication at same potential (UART mode)

(T<sub>A</sub> = -40 to +85°C, 1.6 V ≤ EV<sub>DD0</sub> ≤ V<sub>DD</sub> ≤ 3.6 V, V<sub>SS</sub> = EV<sub>SS0</sub> = 0 V)

Parameter	Symbol	Conditions	HS <sup>Note 1</sup>		LS <sup>Note 2</sup>		LV <sup>Note 3</sup>		Unit
			MIN.	MAX.	MIN.	MAX.	MIN.	MAX.	
Transfer rate <sup>Note 4</sup>		2.4 V ≤ EV <sub>DD</sub> ≤ 3.6 V		f <sub>MCK</sub> /6		f <sub>MCK</sub> /6		f <sub>MCK</sub> /6	bps
		Theoretical value of the maximum transfer rate f <sub>MCK</sub> = f <sub>CLK</sub> <sup>Note 6</sup>		5.3 <sup>Note 5</sup>		1.3		0.6	Mbps
		1.8 V ≤ EV <sub>DD</sub> ≤ 3.6 V		f <sub>MCK</sub> /6		f <sub>MCK</sub> /6		f <sub>MCK</sub> /6	bps
		Theoretical value of the maximum transfer rate f <sub>MCK</sub> = f <sub>CLK</sub> <sup>Note 6</sup>		5.3 <sup>Note 5</sup>		1.3		0.6	Mbps
		1.7 V ≤ EV <sub>DD</sub> ≤ 3.6 V		f <sub>MCK</sub> /6		f <sub>MCK</sub> /6		f <sub>MCK</sub> /6	bps
		Theoretical value of the maximum transfer rate f <sub>MCK</sub> = f <sub>CLK</sub> <sup>Note 6</sup>		5.3 <sup>Note 5</sup>		1.3 <sup>Note 5</sup>		0.6	Mbps
		1.6 V ≤ EV <sub>DD</sub> ≤ 3.6 V		-		f <sub>MCK</sub> /6		f <sub>MCK</sub> /6	bps
		Theoretical value of the maximum transfer rate f <sub>MCK</sub> = f <sub>CLK</sub> <sup>Note 6</sup>		-		1.3 <sup>Note 5</sup>		0.6	Mbps

- Notes 1.** HS is condition of HS (high-speed main) mode.  
**2.** LS is condition of LS (low-speed main) mode.  
**3.** LV is condition of LV (low-voltage main) mode.  
**4.** Transfer rate in the SNOOZE mode is 4800 bps.  
**5.** The following conditions are required for low-voltage interface when EV<sub>DD0</sub> < V<sub>DD</sub>.  
 2.4 V ≤ EV<sub>DD0</sub> < 2.7 V : MAX. 2.6 Mbps  
 1.8 V ≤ EV<sub>DD0</sub> < 2.4 V : MAX. 1.3 Mbps  
 1.6 V ≤ EV<sub>DD0</sub> < 1.8 V : MAX. 0.6 Mbps  
**6.** f<sub>CLK</sub> in each operating mode is as below.  
 HS (high-speed main) mode: f<sub>CLK</sub> = 32 MHz  
 LS (low-speed main) mode: f<sub>CLK</sub> = 8 MHz  
 LV (low-voltage main) mode: f<sub>CLK</sub> = 4 MHz

**Caution** Select the normal input buffer for the RxDq pin and the normal output mode for the TxDq pin by using port input mode register g (PIMg) and port output mode register g (POMg).

**UART mode connection diagram (during communication at same potential)**

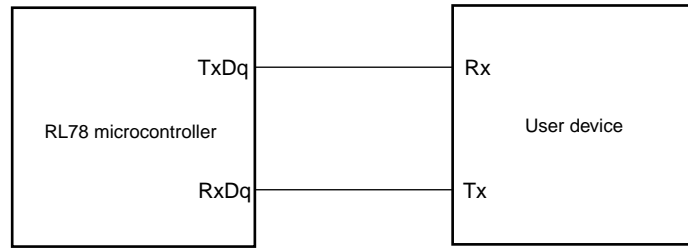

**UART mode bit width (during communication at same potential) (reference)**

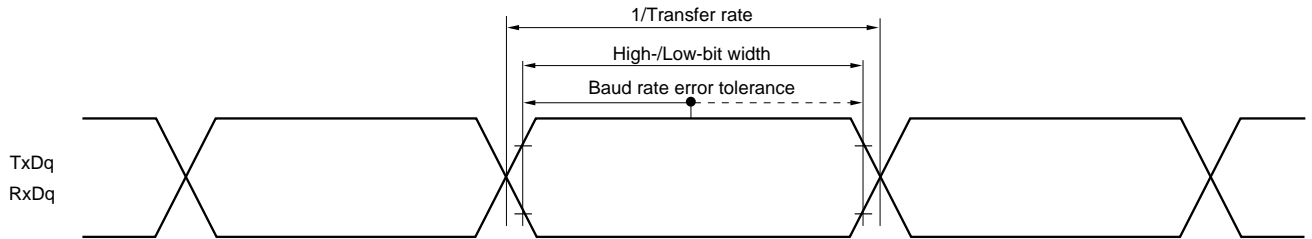

- Remarks**
1. q: UART number (q = 0 to 2), g: PIM and POM number (g = 0, 1)
  2. f<sub>MCK</sub>: Serial array unit operation clock frequency  
 (Operation clock to be set by the CKSmn bit of serial mode register mn (SMRmn). m: Unit number, n: Channel number (mn = 00 to 03, 10, 11))

(2) During communication at same potential (CSI mode) (master mode, SCKp... internal clock output, corresponding CSI00 only)

(T<sub>A</sub> = -40 to +85°C, 2.7 V ≤ EV<sub>DD0</sub> ≤ V<sub>DD</sub> ≤ 3.6 V, V<sub>SS</sub> = EV<sub>SS0</sub> = 0 V)

Parameter	Symbol	Conditions	HS <sup>Note 1</sup>		LS <sup>Note 2</sup>		LV <sup>Note 3</sup>		Unit
			MIN.	MAX.	MIN.	MAX.	MIN.	MAX.	
SCKp cycle time	t <sub>KCY1</sub>	2.7 V ≤ EV <sub>DD</sub> ≤ 3.6 V    t <sub>KCY1</sub> ≥ 2/f <sub>CLK</sub>	83.3		250		500		ns
SCKp high-/low-level width	t <sub>KH1</sub> , t <sub>KL1</sub>	2.7 V ≤ EV <sub>DD</sub> ≤ 3.6 V	t <sub>KCY1</sub> /2 -10		t <sub>KCY1</sub> /2 -50		t <sub>KCY1</sub> /2 -50		ns
Slp setup time (to SCKp↑) <sup>Note 4</sup>	t <sub>SIK1</sub>	2.7 V ≤ EV <sub>DD</sub> ≤ 3.6 V	33		110		110		ns
Slp hold time (from SCKp↑) <sup>Note 4</sup>	t <sub>KSI1</sub>	2.7 V ≤ EV <sub>DD</sub> ≤ 3.6 V	10		10		10		ns
Delay time from SCKp↓ to SOp output <sup>Note 5</sup>	t <sub>KSO1</sub>	C = 20 pF <sup>Note 6</sup>		10		10		10	ns

**Notes 1.** HS is condition of HS (high-speed main) mode.

**2.** LS is condition of LS (low-speed main) mode.

**3.** LV is condition of LV (low-voltage main) mode.

**4.** When DAP<sub>mn</sub> = 0 and CKP<sub>mn</sub> = 0, or DAP<sub>mn</sub> = 1 and CKP<sub>mn</sub> = 1. The Slp setup time or Slp hold time becomes "from SCKp↓" when DAP<sub>mn</sub> = 0 and CKP<sub>mn</sub> = 1, or DAP<sub>mn</sub> = 1 and CKP<sub>mn</sub> = 0.

**5.** When DAP<sub>mn</sub> = 0 and CKP<sub>mn</sub> = 0, or DAP<sub>mn</sub> = 1 and CKP<sub>mn</sub> = 1. The delay time to SOp output becomes "from SCKp↑" when DAP<sub>mn</sub> = 0 and CKP<sub>mn</sub> = 1, or DAP<sub>mn</sub> = 1 and CKP<sub>mn</sub> = 0.

**6.** C is the load capacitance of the SCKp and SOp output lines.

**Caution** Select the normal input buffer for the Slp pin and the normal output mode for the SOp pin and SCKp pin by using port input mode register g (PIMg) and port output mode register g (POMg).

**Remarks 1.** p: CSI number (p = 00), m: Unit number (m = 0), n: Channel number (n = 0),  
g: PIM and POM numbers (g = 1)

**2.** f<sub>MCK</sub>: Serial array unit operation clock frequency  
(Operation clock to be set by the CKS<sub>mn</sub> bit of serial mode register mn (SMR<sub>mn</sub>). m: Unit number,  
n: Channel number (mn = 00))



**(3) During communication at same potential (CSI mode) (master mode, SCKp... internal clock output)**  
**(T<sub>A</sub> = -40 to +85°C, 1.6 V ≤ EV<sub>DD0</sub> ≤ V<sub>DD</sub> ≤ 3.6 V, V<sub>SS</sub> = EV<sub>SS0</sub> = 0 V)**

Parameter	Symbol	Conditions	HS <sup>Note 1</sup>		LS <sup>Note 2</sup>		LV <sup>Note 3</sup>		Unit	
			MIN.	MAX.	MIN.	MAX.	MIN.	MAX.		
SCKp cycle time	t <sub>KCY2</sub>	2.7 V ≤ EV <sub>DD0</sub> ≤ 3.6 V	t <sub>KCY1</sub> ≥ 4/f <sub>CLK</sub>	125		500		1000	ns	
		2.4 V ≤ EV <sub>DD0</sub> ≤ 3.6 V	t <sub>KCY1</sub> ≥ 4/f <sub>CLK</sub>	250		500		1000	ns	
		1.8 V ≤ EV <sub>DD0</sub> ≤ 3.6 V	t <sub>KCY1</sub> ≥ 4/f <sub>CLK</sub>	500		500		1000	ns	
		1.7 V ≤ EV <sub>DD0</sub> ≤ 3.6 V	t <sub>KCY1</sub> ≥ 4/f <sub>CLK</sub>	1000		1000		1000	ns	
		1.6 V ≤ EV <sub>DD0</sub> ≤ 3.6 V	t <sub>KCY1</sub> ≥ 4/f <sub>CLK</sub>	–		1000		1000	ns	
SCKp high-/low-level width	t <sub>KH2</sub> , t <sub>KL2</sub>	2.7 V ≤ EV <sub>DD0</sub> ≤ 3.6 V		t <sub>KCY2</sub> /2 –18		t <sub>KCY2</sub> /2 –50		t <sub>KCY2</sub> /2 –50	ns	
		2.4 V ≤ EV <sub>DD0</sub> ≤ 3.6 V		t <sub>KCY2</sub> /2 –38		t <sub>KCY2</sub> /2 –50		t <sub>KCY2</sub> /2 –50	ns	
		1.8 V ≤ EV <sub>DD0</sub> ≤ 3.6 V		t <sub>KCY2</sub> /2 –50		t <sub>KCY2</sub> /2 –50		t <sub>KCY2</sub> /2 –50	ns	
		1.7 V ≤ EV <sub>DD0</sub> ≤ 3.6 V		t <sub>KCY2</sub> /2 –100		t <sub>KCY2</sub> /2 –100		t <sub>KCY2</sub> /2 –100	ns	
		1.6 V ≤ EV <sub>DD0</sub> ≤ 3.6 V		–		t <sub>KCY2</sub> /2 –100		t <sub>KCY2</sub> /2 –100	ns	
Slp setup time (to SCKp↑) <sup>Note 4</sup>	t <sub>SIK2</sub>	2.7 V ≤ EV <sub>DD0</sub> ≤ 3.6 V		44		110		110	ns	
		2.4 V ≤ EV <sub>DD0</sub> ≤ 3.6 V		75		110		110	ns	
		1.8 V ≤ EV <sub>DD0</sub> ≤ 3.6 V		110		110		110	ns	
		1.7 V ≤ EV <sub>DD0</sub> ≤ 3.6 V		220		220		220	ns	
		1.6 V ≤ EV <sub>DD0</sub> ≤ 3.6 V		–		220		220	ns	
Slp hold time (from SCKp↑) <sup>Note 4</sup>	t <sub>SI2</sub>	1.7 V ≤ EV <sub>DD</sub> ≤ 3.6 V		19		19		19	ns	
		1.6 V ≤ EV <sub>DD</sub> ≤ 3.6 V		–		19		19	ns	
Delay time from SCKp↓ to SOp output <sup>Note 5</sup>	t <sub>KS02</sub>	1.7 V ≤ EV <sub>DD</sub> ≤ 3.6 V	C = 30 pF <sup>Note 6</sup>		25		25		25	ns
		1.6 V ≤ EV <sub>DD</sub> ≤ 3.6 V	C = 30 pF <sup>Note 6</sup>		–		25		25	ns

**Notes 1.** HS is condition of HS (high-speed main) mode.

**2.** LS is condition of LS (low-speed main) mode.

**3.** LV is condition of LV (low-voltage main) mode.

**4.** When DAP<sub>m</sub>n = 0 and CKP<sub>m</sub>n = 0, or DAP<sub>m</sub>n = 1 and CKP<sub>m</sub>n = 1. The Slp setup time or Slp hold time becomes “from SCKp↓” when DAP<sub>m</sub>n = 0 and CKP<sub>m</sub>n = 1, or DAP<sub>m</sub>n = 1 and CKP<sub>m</sub>n = 0.

**5.** When DAP<sub>m</sub>n = 0 and CKP<sub>m</sub>n = 0, or DAP<sub>m</sub>n = 1 and CKP<sub>m</sub>n = 1. The delay time to SOp output becomes “from SCKp↑” when DAP<sub>m</sub>n = 0 and CKP<sub>m</sub>n = 1, or DAP<sub>m</sub>n = 1 and CKP<sub>m</sub>n = 0.

**6.** C is the load capacitance of the SCKp and SOp output lines.

**Caution** Select the normal input buffer for the Slp pin and the normal output mode for the SOp pin and SCKp pin by using port input mode register g (PIMg) and port output mode register g (POMg).

**Remark** p: CSI number (p = 00, 01, 10, 11, 20, 21), m: Unit number (m = 0, 1), n: Channel number (n = 0 to 3), g: PIM and POM numbers (g = 0, 1)

## (4) During communication at same potential (CSI mode) (slave mode, SCKp... external clock input)

(T<sub>A</sub> = -40 to +85°C, 1.6 V ≤ EV<sub>DD0</sub> ≤ V<sub>DD</sub> ≤ 3.6 V, V<sub>SS</sub> = EV<sub>SS0</sub> = 0 V)

Parameter	Symbol	Conditions		HS <sup>Note 1</sup>		LS <sup>Note 2</sup>		LV <sup>Note 3</sup>		Unit
				MIN.	MAX.	MIN.	MAX.	MIN.	MAX.	
SCKp cycle time <sup>Note 4</sup>	t <sub>KCY2</sub>	2.7 V ≤ EV <sub>DD0</sub> ≤ 3.6 V	16 MHz < f <sub>MCK</sub>	8/f <sub>MCK</sub>		–		–		ns
			f <sub>MCK</sub> ≤ 16 MHz	6/f <sub>MCK</sub>		6/f <sub>MCK</sub>		6/f <sub>MCK</sub>		ns
		2.4 V ≤ EV <sub>DD0</sub> ≤ 3.6 V		6/f <sub>MCK</sub> and 500ns		6/f <sub>MCK</sub> and 500ns		6/f <sub>MCK</sub> and 500ns		ns
		1.8 V ≤ EV <sub>DD0</sub> ≤ 3.6 V		6/f <sub>MCK</sub> and 750ns		6/f <sub>MCK</sub> and 750ns		6/f <sub>MCK</sub> and 750ns		ns
		1.7 V ≤ EV <sub>DD0</sub> ≤ 3.6 V		6/f <sub>MCK</sub> and 1500ns		6/f <sub>MCK</sub> and 1500ns		6/f <sub>MCK</sub> and 1500ns		ns
1.6 V ≤ EV <sub>DD0</sub> ≤ 3.6 V			–		6/f <sub>MCK</sub> and 1500ns		6/f <sub>MCK</sub> and 1500ns		ns	
SCKp high-/low-level width	t <sub>KH2</sub> , t <sub>KL2</sub>	2.7 V ≤ EV <sub>DD0</sub> ≤ 3.6 V		t <sub>KCY2</sub> /2 –8		t <sub>KCY2</sub> /2 –8		t <sub>KCY2</sub> /2 –8		ns
		1.8 V ≤ EV <sub>DD0</sub> ≤ 3.6 V		t <sub>KCY2</sub> /2 –18		t <sub>KCY2</sub> /2 –18		t <sub>KCY2</sub> /2 –18		ns
		1.7 V ≤ EV <sub>DD0</sub> ≤ 3.6 V		t <sub>KCY2</sub> /2 –66		t <sub>KCY2</sub> /2 –66		t <sub>KCY2</sub> /2 –66		ns
		1.6 V ≤ EV <sub>DD0</sub> ≤ 3.6 V			–	t <sub>KCY2</sub> /2 –66		t <sub>KCY2</sub> /2 –66		ns
Slp setup time (to SCKp↑) <sup>Note 5</sup>	t <sub>SIK2</sub>	2.7 V ≤ EV <sub>DD0</sub> ≤ 3.6 V		1/f <sub>MCK</sub> +20		1/f <sub>MCK</sub> +30		1/f <sub>MCK</sub> +30		ns
		1.8 V ≤ EV <sub>DD0</sub> ≤ 3.6 V		1/f <sub>MCK</sub> +30		1/f <sub>MCK</sub> +30		1/f <sub>MCK</sub> +30		ns
		1.7 V ≤ EV <sub>DD0</sub> ≤ 3.6 V		1/f <sub>MCK</sub> +40		1/f <sub>MCK</sub> +40		1/f <sub>MCK</sub> +40		ns
		1.6 V ≤ EV <sub>DD0</sub> ≤ 3.6 V			–	1/f <sub>MCK</sub> +40		1/f <sub>MCK</sub> +40		ns
Slp hold time (from SCKp↑) <sup>Note 5</sup>	t <sub>SIK2</sub>	1.8 V ≤ EV <sub>DD0</sub> ≤ 3.6 V		1/f <sub>MCK</sub> +31		1/f <sub>MCK</sub> +31		1/f <sub>MCK</sub> +31		ns
		1.7 V ≤ EV <sub>DD0</sub> ≤ 3.6 V		1/f <sub>MCK</sub> +250		1/f <sub>MCK</sub> +250		1/f <sub>MCK</sub> +250		ns
		1.6 V ≤ EV <sub>DD0</sub> ≤ 3.6 V			–	1/f <sub>MCK</sub> +250		1/f <sub>MCK</sub> +250		ns
Delay time from SCKp↓ to SOp output <sup>Note 6</sup>	t <sub>KSO2</sub>	C = 30 pF <sup>Note 7</sup>	2.7 V ≤ EV <sub>DD0</sub> ≤ 3.6 V		2/f <sub>MCK</sub> +44		2/f <sub>MCK</sub> +110		2/f <sub>MCK</sub> +110	ns
			2.4 V ≤ EV <sub>DD0</sub> ≤ 3.6 V		2/f <sub>MCK</sub> +75		2/f <sub>MCK</sub> +110		2/f <sub>MCK</sub> +110	ns
			1.8 V ≤ EV <sub>DD0</sub> ≤ 3.6 V		2/f <sub>MCK</sub> +110		2/f <sub>MCK</sub> +110		2/f <sub>MCK</sub> +110	ns
			1.7 V ≤ EV <sub>DD0</sub> ≤ 3.6 V		2/f <sub>MCK</sub> +220		2/f <sub>MCK</sub> +220		2/f <sub>MCK</sub> +220	ns
			1.6 V ≤ EV <sub>DD0</sub> ≤ 3.6 V			–	2/f <sub>MCK</sub> +220		2/f <sub>MCK</sub> +220	ns

(Note, Caution and Remark are listed on the next page.)

- Notes**
1. HS is condition of HS (high-speed main) mode.
  2. LS is condition of LS (low-speed main) mode.
  3. LV is condition of LV (low-voltage main) mode.
  4. Transfer rate in the SNOOZE mode: MAX. 1 Mbps
  5. When DAP<sub>mn</sub> = 0 and CKP<sub>mn</sub> = 0, or DAP<sub>mn</sub> = 1 and CKP<sub>mn</sub> = 1. The SIp setup time or SIp hold time becomes “from SCKp↓” when DAP<sub>mn</sub> = 0 and CKP<sub>mn</sub> = 1, or DAP<sub>mn</sub> = 1 and CKP<sub>mn</sub> = 0.
  6. When DAP<sub>mn</sub> = 0 and CKP<sub>mn</sub> = 0, or DAP<sub>mn</sub> = 1 and CKP<sub>mn</sub> = 1. The delay time to SOp output becomes “from SCKp↑” when DAP<sub>mn</sub> = 0 and CKP<sub>mn</sub> = 1, or DAP<sub>mn</sub> = 1 and CKP<sub>mn</sub> = 0.
  7. C is the load capacitance of the SOp output lines.

**Caution** Select the normal input buffer for the SIp pin and SCKp pin and the normal output mode for the SOp pin by using port input mode register g (PIMg) and port output mode register g (POMg).

- Remarks**
1. p: CSI number (p = 00, 01, 10, 11, 20, 21), m: Unit number (m = 0, 1), n: Channel number (n = 0 to 3),  
g: PIM number (g = 0, 1)
  2. f<sub>MCK</sub>: Serial array unit operation clock frequency  
(Operation clock to be set by the CKS<sub>mn</sub> bit of serial mode register mn (SMR<sub>mn</sub>). m: Unit number, n: Channel number (mn = 00 to 03, 10, 11))

**CSI mode connection diagram (during communication at same potential)**

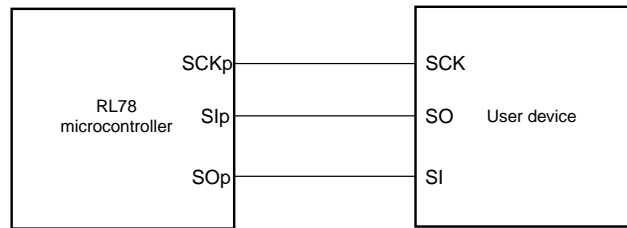

**CSI mode serial transfer timing (during communication at same potential)**  
 (When DAPmn = 0 and CKPmn = 0, or DAPmn = 1 and CKPmn = 1.)

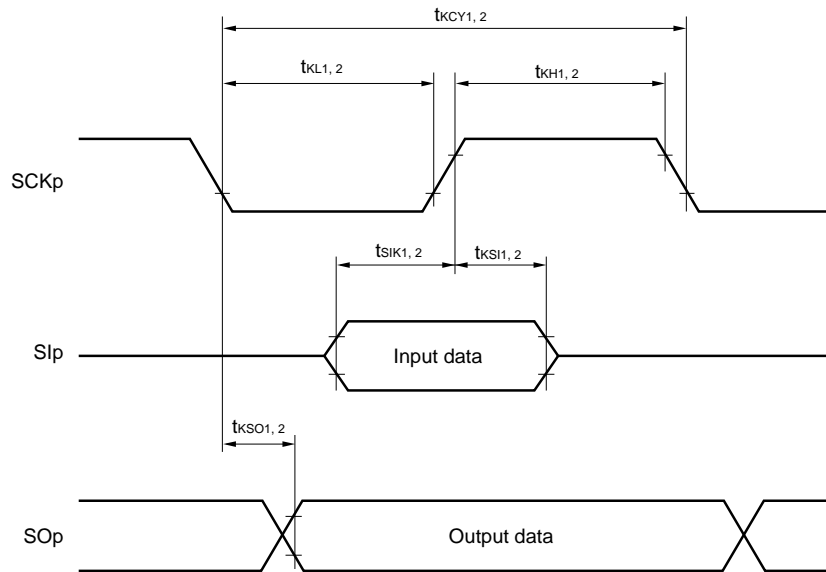

**CSI mode serial transfer timing (during communication at same potential)**  
 (When DAPmn = 0 and CKPmn = 1, or DAPmn = 1 and CKPmn = 0.)

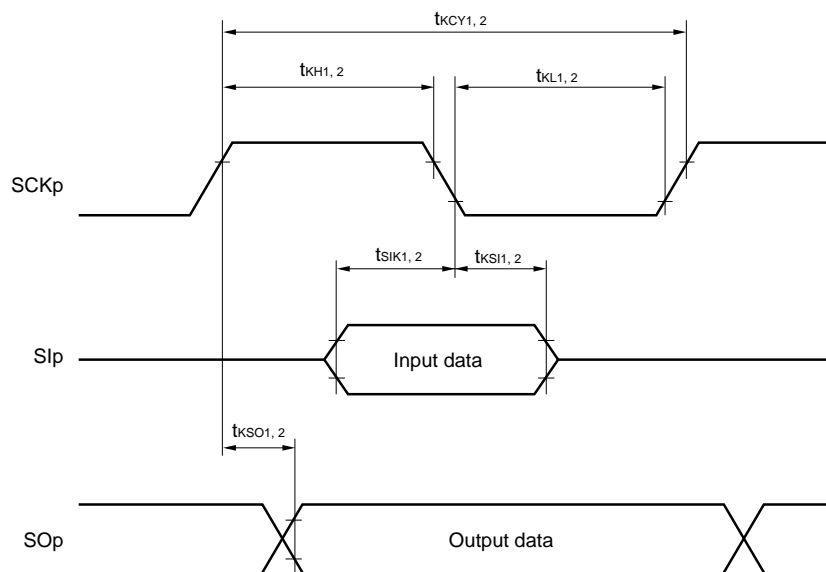

- Remarks**
1. p: CSI number (p = 00, 01, 10, 11, 20, 21)
  2. m: Unit number, n: Channel number (mn = 00 to 03, 10, 11)

(5) During communication at same potential (simplified I<sup>2</sup>C mode) (1/2)(T<sub>A</sub> = -40 to +85°C, 1.6 V ≤ EV<sub>DD0</sub> ≤ V<sub>DD</sub> ≤ 3.6 V, V<sub>SS</sub> = EV<sub>SS0</sub> = 0 V)

Parameter	Symbol	Conditions	HS <sup>Note 1</sup>		LS <sup>Note 2</sup>		LV <sup>Note 3</sup>		Unit
			MIN.	MAX.	MIN.	MAX.	MIN.	MAX.	
SCLr clock frequency	f <sub>SCL</sub>	2.7 V ≤ EV <sub>DD0</sub> ≤ 3.6 V, C <sub>b</sub> = 50 pF, R <sub>b</sub> = 2.7 kΩ		1000 <sup>Note 4</sup>		400 <sup>Note 4</sup>		400 <sup>Note 4</sup>	kHz
		1.8 V ≤ EV <sub>DD0</sub> ≤ 3.6 V, C <sub>b</sub> = 100 pF, R <sub>b</sub> = 3 kΩ		400 <sup>Note 4</sup>		400 <sup>Note 4</sup>		400 <sup>Note 4</sup>	kHz
		1.8 V ≤ EV <sub>DD0</sub> < 2.7 V, C <sub>b</sub> = 100 pF, R <sub>b</sub> = 5 kΩ		300 <sup>Note 4</sup>		300 <sup>Note 4</sup>		300 <sup>Note 4</sup>	kHz
		1.7 V ≤ EV <sub>DD0</sub> < 1.8 V, C <sub>b</sub> = 100 pF, R <sub>b</sub> = 5 kΩ		250 <sup>Note 4</sup>		250 <sup>Note 4</sup>		250 <sup>Note 4</sup>	kHz
		1.6 V ≤ EV <sub>DD0</sub> < 1.8 V, C <sub>b</sub> = 100 pF, R <sub>b</sub> = 5 kΩ		–		250 <sup>Note 4</sup>		250 <sup>Note 4</sup>	kHz
Hold time when SCLr = "L"	t <sub>LOW</sub>	2.7 V ≤ EV <sub>DD0</sub> ≤ 3.6 V, C <sub>b</sub> = 50 pF, R <sub>b</sub> = 2.7 kΩ	475		1150		1150		ns
		1.8 V ≤ EV <sub>DD0</sub> ≤ 3.6 V, C <sub>b</sub> = 100 pF, R <sub>b</sub> = 3 kΩ	1150		1150		1150		ns
		1.8 V ≤ EV <sub>DD0</sub> < 2.7 V, C <sub>b</sub> = 100 pF, R <sub>b</sub> = 5 kΩ	1550		1550		1550		ns
		1.7 V ≤ EV <sub>DD0</sub> < 1.8 V, C <sub>b</sub> = 100 pF, R <sub>b</sub> = 5 kΩ	1850		1850		1850		ns
		1.6 V ≤ EV <sub>DD0</sub> < 1.8 V, C <sub>b</sub> = 100 pF, R <sub>b</sub> = 5 kΩ	–		1850		1850		ns
Hold time when SCLr = "H"	t <sub>HIGH</sub>	2.7 V ≤ EV <sub>DD0</sub> ≤ 3.6 V, C <sub>b</sub> = 50 pF, R <sub>b</sub> = 2.7 kΩ	475		1150		1150		ns
		1.8 V ≤ EV <sub>DD0</sub> ≤ 3.6 V, C <sub>b</sub> = 100 pF, R <sub>b</sub> = 3 kΩ	1150		1150		1150		ns
		1.8 V ≤ EV <sub>DD0</sub> < 2.7 V, C <sub>b</sub> = 100 pF, R <sub>b</sub> = 5 kΩ	1550		1550		1550		ns
		1.7 V ≤ EV <sub>DD0</sub> < 1.8 V, C <sub>b</sub> = 100 pF, R <sub>b</sub> = 5 kΩ	1850		1850		1850		ns
		1.6 V ≤ EV <sub>DD0</sub> < 1.8 V, C <sub>b</sub> = 100 pF, R <sub>b</sub> = 5 kΩ	–		1850		1850		ns
Data setup time (reception)	t <sub>SU:DAT</sub>	2.7 V ≤ EV <sub>DD0</sub> ≤ 3.6 V, C <sub>b</sub> = 50 pF, R <sub>b</sub> = 2.7 kΩ	1/f <sub>MCK</sub> + 85 <sup>Note 5</sup>		1/f <sub>MCK</sub> + 145 <sup>Note 5</sup>		1/f <sub>MCK</sub> + 145 <sup>Note 5</sup>		ns
		1.8 V ≤ EV <sub>DD0</sub> ≤ 3.6 V, C <sub>b</sub> = 100 pF, R <sub>b</sub> = 3 kΩ	1/f <sub>MCK</sub> + 145 <sup>Note 5</sup>		1/f <sub>MCK</sub> + 145 <sup>Note 5</sup>		1/f <sub>MCK</sub> + 145 <sup>Note 5</sup>		ns
		1.8 V ≤ EV <sub>DD0</sub> < 2.7 V, C <sub>b</sub> = 100 pF, R <sub>b</sub> = 5 kΩ	1/f <sub>MCK</sub> + 230 <sup>Note 5</sup>		1/f <sub>MCK</sub> + 230 <sup>Note 5</sup>		1/f <sub>MCK</sub> + 230 <sup>Note 5</sup>		ns
		1.7 V ≤ EV <sub>DD0</sub> < 1.8 V, C <sub>b</sub> = 100 pF, R <sub>b</sub> = 5 kΩ	1/f <sub>MCK</sub> + 290 <sup>Note 5</sup>		1/f <sub>MCK</sub> + 290 <sup>Note 5</sup>		1/f <sub>MCK</sub> + 290 <sup>Note 5</sup>		ns
		1.6 V ≤ EV <sub>DD0</sub> < 1.8 V, C <sub>b</sub> = 100 pF, R <sub>b</sub> = 5 kΩ	–		1/f <sub>MCK</sub> + 290 <sup>Note 5</sup>		1/f <sub>MCK</sub> + 290 <sup>Note 5</sup>		ns

(Notes, Caution and Remarks are listed on the next page.)

**(5) During communication at same potential (simplified I<sup>2</sup>C mode) (2/2)**

(T<sub>A</sub> = -40 to +85°C, 1.6 V ≤ EV<sub>DD0</sub> ≤ V<sub>DD</sub> ≤ 3.6 V, V<sub>SS</sub> = EV<sub>SS0</sub> = 0 V)

Parameter	Symbol	Conditions	HS <sup>Note 1</sup>		LS <sup>Note 2</sup>		LV <sup>Note 3</sup>		Unit
			MIN.	MAX.	MIN.	MAX.	MIN.	MAX.	
Data hold time (transmission)	t <sub>HD:DAT</sub>	2.7 V ≤ EV <sub>DD0</sub> ≤ 3.6 V, C <sub>b</sub> = 50 pF, R <sub>b</sub> = 2.7 kΩ	0	305	0	305	0	305	ns
		1.8 V ≤ EV <sub>DD0</sub> ≤ 3.6 V, C <sub>b</sub> = 100 pF, R <sub>b</sub> = 3 kΩ	0	355	0	355	0	355	ns
		1.8 V ≤ EV <sub>DD0</sub> < 2.7 V, C <sub>b</sub> = 100 pF, R <sub>b</sub> = 5 kΩ	0	405	0	405	0	405	ns
		1.7 V ≤ EV <sub>DD0</sub> ≤ 1.8 V, C <sub>b</sub> = 100 pF, R <sub>b</sub> = 5 kΩ	0	405	0	405	0	405	ns
		1.6 V ≤ EV <sub>DD0</sub> < 1.8 V, C <sub>b</sub> = 100 pF, R <sub>b</sub> = 5 kΩ	-	-	0	405	0	405	ns

- Notes 1.** HS is condition of HS (high-speed main) mode.
- 2.** LS is condition of LS (low-speed main) mode.
- 3.** LV is condition of LV (low-voltage main) mode.
- 4.** The value must also be f<sub>CLK</sub>/4 or lower.
- 5.** Set the f<sub>MCK</sub> value to keep the hold time of SCLr = "L" and SCLr = "H".

**Caution** Select the normal input buffer and the N-ch open drain output (V<sub>DD</sub> tolerance (When 25- to 48-pin products)/EV<sub>DD</sub> tolerance (When 64-pin products)) mode for the SDAr pin and the normal output mode for the SCLr pin by using port input mode register g (PIMg) and port output mode register h (POMh).

**Simplified I<sup>2</sup>C mode mode connection diagram (during communication at same potential)**

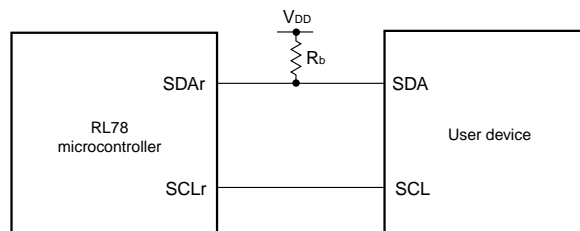

**Simplified I<sup>2</sup>C mode serial transfer timing (during communication at same potential)**

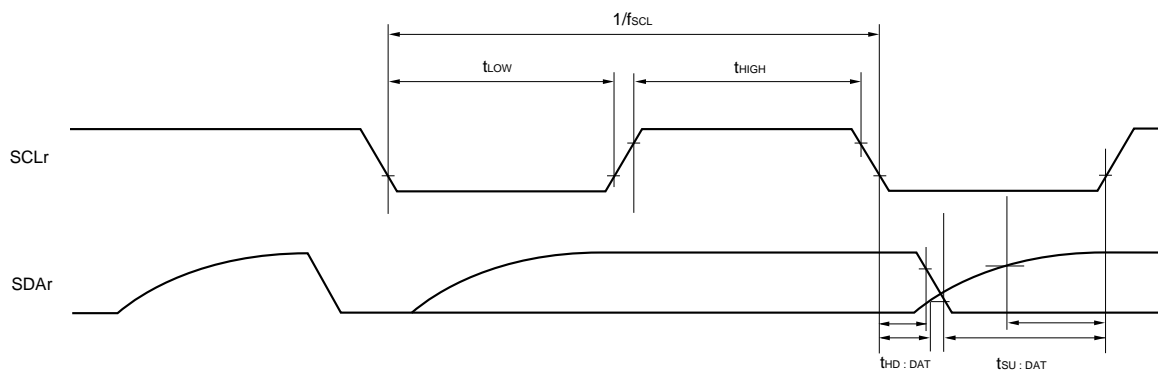

- Remarks 1.** R<sub>b</sub>[Ω]: Communication line (SDAr) pull-up resistance, C<sub>b</sub>[F]: Communication line (SDAr, SCLr) load capacitance
- 2.** r: IIC number (r = 00, 01, 10, 11, 20, 21), g: PIM number (g = 0, 1), h: POM number (h = 0, 1)
- 3.** f<sub>MCK</sub>: Serial array unit operation clock frequency  
(Operation clock to be set by the CKSmn bit of serial mode register mn (SMRmn). m: Unit number, n: Channel number, mn = 00 to 03, 10, 11)

**(6) Communication at different potential (1.8 V, 2.5 V) (UART mode) (dedicated baud rate generator output)**  
(1/2)

(T<sub>A</sub> = -40 to +85°C, 1.8 V ≤ EV<sub>DD0</sub> ≤ V<sub>DD</sub> ≤ 3.6 V, V<sub>SS</sub> = EV<sub>SS0</sub> = 0 V)

Parameter	Symbol	Conditions		HS <sup>Note 1</sup>		LS <sup>Note 2</sup>		LV <sup>Note 3</sup>		Unit
				MIN.	MAX.	MIN.	MAX.	MIN.	MAX.	
Transfer rate <sup>Note 4</sup>		Reception	2.7 V ≤ EV <sub>DD0</sub> ≤ 3.6 V, 2.3 V ≤ V <sub>b</sub> ≤ 2.7 V		f <sub>MCK</sub> /6		f <sub>MCK</sub> /6		f <sub>MCK</sub> /6	bps
					Theoretical value of the maximum transfer rate f <sub>MCK</sub> = f <sub>CLK</sub> <sup>Note 7</sup>		5.3		1.3	
			1.8 V ≤ EV <sub>DD0</sub> < 3.3 V, 1.6 V ≤ V <sub>b</sub> ≤ 2.0 V <sup>Note 5</sup>		f <sub>MCK</sub> /6		f <sub>MCK</sub> /6		f <sub>MCK</sub> /6	bps
					Theoretical value of the maximum transfer rate f <sub>MCK</sub> = f <sub>CLK</sub> <sup>Note 7</sup>		5.3 <sup>Note 6</sup>		1.3	

- Notes 1.** HS is condition of HS (high-speed main) mode.  
**2.** LS is condition of LS (low-speed main) mode.  
**3.** LV is condition of LV (low-voltage main) mode.  
**4.** Transfer rate in the SNOOZE mode is 4800 bps.  
**5.** Use it with EV<sub>DD0</sub> ≥ V<sub>b</sub>.  
**6.** The following conditions are required for low-voltage interface when EV<sub>DD0</sub> < V<sub>DD</sub>.  
 2.4 V ≤ EV<sub>DD0</sub> < 2.7 V : MAX. 2.6 Mbps  
 1.8 V ≤ EV<sub>DD0</sub> < 2.4 V : MAX. 1.3 Mbps  
**7.** f<sub>CLK</sub> in each operating mode is as below.  
 HS (high-speed main) mode: f<sub>CLK</sub> = 32 MHz  
 LS (low-speed main) mode: f<sub>CLK</sub> = 8 MHz  
 LV (low-voltage main) mode: f<sub>CLK</sub> = 4 MHz

**Caution** Select the TTL input buffer for the RxDq pin and the N-ch open drain output (V<sub>DD</sub> tolerance (When 25- to 48-pin products)/EV<sub>DD</sub> tolerance (When 64-pin products)) mode for the TxDq pin by using port input mode register g (PIMg) and port output mode register g (POMg). For V<sub>IH</sub> and V<sub>IL</sub>, see the DC characteristics with TTL input buffer selected.

- Remarks 1.** V<sub>b</sub>[V]: Communication line voltage  
**2.** q: UART number (q = 0 to 2), g: PIM and POM number (g = 0, 1)  
**3.** f<sub>MCK</sub>: Serial array unit operation clock frequency  
 (Operation clock to be set by the CKSmn bit of serial mode register mn (SMRmn). m: Unit number, n: Channel number (mn = 00 to 03, 10, 11))

**(6) Communication at different potential (1.8 V, 2.5 V) (UART mode) (dedicated baud rate generator output)**  
**(2/2)**

(T<sub>A</sub> = -40 to +85°C, 1.8 V ≤ EV<sub>DD0</sub> ≤ V<sub>DD</sub> ≤ 3.6 V, V<sub>SS</sub> = EV<sub>SS0</sub> = 0 V)

Parameter	Symbol	Conditions		HS <sup>Note 1</sup>		LS <sup>Note 2</sup>		LV <sup>Note 3</sup>		Unit
				MIN.	MAX.	MIN.	MAX.	MIN.	MAX.	
Transfer rate		Transmission	2.7 V ≤ EV <sub>DD0</sub> ≤ 3.6 V, 2.3 V ≤ V <sub>b</sub> ≤ 2.7 V		Note 4		Note 4		Note 4	bps
					1.2 Note 5		1.2 Note 5		1.2 Note 5	Mbps
			1.8 V ≤ EV <sub>DD0</sub> < 3.3 V, 1.6 V ≤ V <sub>b</sub> ≤ 2.0 V <sup>Note 6</sup>		Note 7		Note 7		Note 7	bps
					0.43 Note 8		0.43 Note 8		0.43 Note 8	Mbps

- Notes**
- HS is condition of HS (high-speed main) mode.
  - LS is condition of LS (low-speed main) mode.
  - LV is condition of LV (low-voltage main) mode.
  - The smaller maximum transfer rate derived by using f<sub>MCK</sub>/6 or the following expression is the valid maximum transfer rate.

Expression for calculating the transfer rate when 2.7 V ≤ EV<sub>DD0</sub> ≤ 3.6 V and 2.3 V ≤ V<sub>b</sub> ≤ 2.7 V

$$\text{Maximum transfer rate} = \frac{1}{\{-C_b \times R_b \times \ln(1 - \frac{2.0}{V_b})\} \times 3} \quad [\text{bps}]$$

$$\text{Baud rate error (theoretical value)} = \frac{\frac{1}{\text{Transfer rate} \times 2} - \{-C_b \times R_b \times \ln(1 - \frac{2.0}{V_b})\}}{(\frac{1}{\text{Transfer rate}}) \times \text{Number of transferred bits}} \times 100 \quad [\%]$$

\* This value is the theoretical value of the relative difference between the transmission and reception sides.

- This value as an example is calculated when the conditions described in the “Conditions” column are met. See **Note 4** above to calculate the maximum transfer rate under conditions of the customer.
- Use it with EV<sub>DD0</sub> ≥ V<sub>b</sub>.
- The smaller maximum transfer rate derived by using f<sub>MCK</sub>/6 or the following expression is the valid maximum transfer rate.

Expression for calculating the transfer rate when 1.8 V ≤ EV<sub>DD0</sub> < 3.3 V and 1.6 V ≤ V<sub>b</sub> ≤ 2.0 V

$$\text{Maximum transfer rate} = \frac{1}{\{-C_b \times R_b \times \ln(1 - \frac{1.5}{V_b})\} \times 3} \quad [\text{bps}]$$

$$\text{Baud rate error (theoretical value)} = \frac{\frac{1}{\text{Transfer rate} \times 2} - \{-C_b \times R_b \times \ln(1 - \frac{1.5}{V_b})\}}{(\frac{1}{\text{Transfer rate}}) \times \text{Number of transferred bits}} \times 100 \quad [\%]$$

\* This value is the theoretical value of the relative difference between the transmission and reception sides.

- This value as an example is calculated when the conditions described in the “Conditions” column are met. See **Note 7** above to calculate the maximum transfer rate under conditions of the customer.

**Caution** Select the TTL input buffer for the RxDq pin and the N-ch open drain output (V<sub>DD</sub> tolerance (When 25- to 48-pin products)/EV<sub>DD</sub> tolerance (When 64-pin products)) mode for the TxDq pin by using port input mode register g (PIMg) and port output mode register g (POMg). For V<sub>IH</sub> and V<sub>IL</sub>, see the DC characteristics with TTL input buffer selected.

<R>



**UART mode connection diagram (during communication at different potential)**

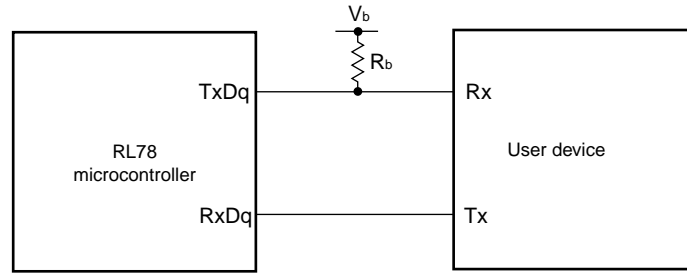

**UART mode bit width (during communication at different potential) (reference)**

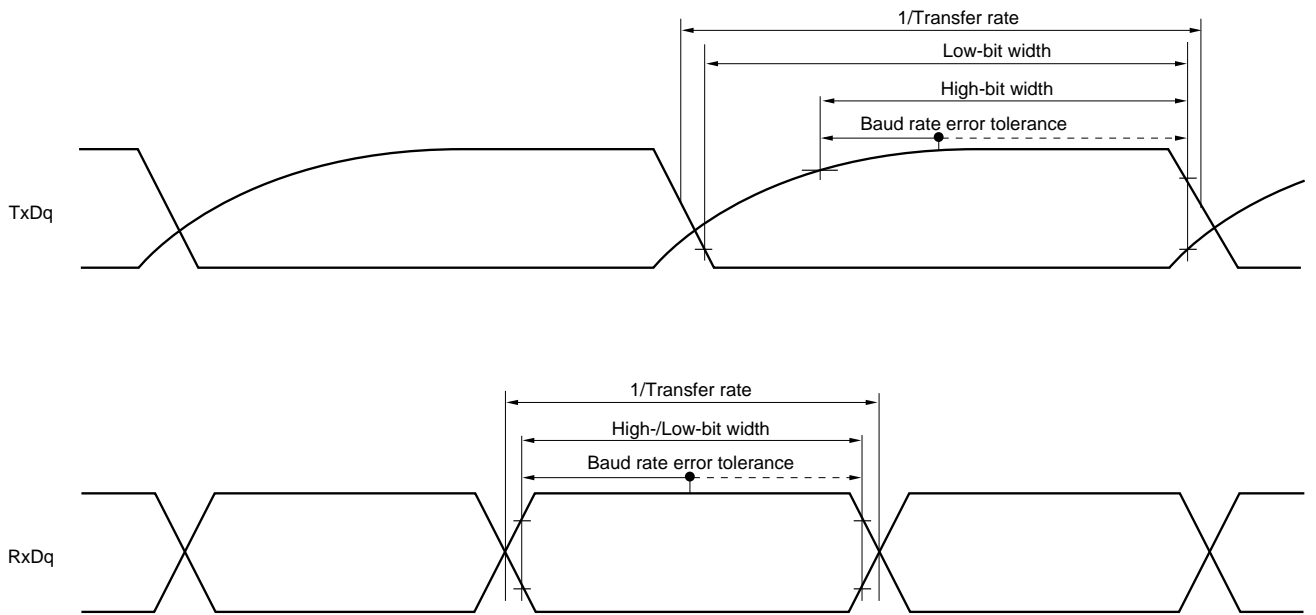

- Remarks**
1. R<sub>b</sub>[Ω]: Communication line (TxDq) pull-up resistance,  
C<sub>b</sub>[F]: Communication line (TxDq) load capacitance, V<sub>b</sub>[V]: Communication line voltage
  2. q: UART number (q = 0 to 2), g: PIM and POM number (g = 0, 1)
  3. f<sub>MCK</sub>: Serial array unit operation clock frequency  
(Operation clock to be set by the CKSmn bit of serial mode register mn (SMRmn).  
m: Unit number, n: Channel number (mn = 00 to 03, 10, 11))

**(7) Communication at different potential (2.5 V) (CSI mode) (master mode, SCKp... internal clock output, corresponding CSI00 only)**

(T<sub>A</sub> = -40 to +85°C, 2.7 V ≤ EV<sub>DD0</sub> ≤ V<sub>DD</sub> ≤ 3.6 V, V<sub>SS</sub> = EV<sub>SS0</sub> = 0 V)

Parameter	Symbol	Conditions	HS <sup>Note 1</sup>		LS <sup>Note 2</sup>		LV <sup>Note 3</sup>		Unit	
			MIN.	MAX.	MIN.	MAX.	MIN.	MAX.		
SCKp cycle time	t <sub>KCY1</sub>	2.7 V ≤ EV <sub>DD0</sub> ≤ 3.6 V, 2.3 V ≤ V <sub>b</sub> ≤ 2.7 V, C <sub>b</sub> = 20 pF, R <sub>b</sub> = 2.7 kΩ	t <sub>KCY1</sub> ≥ 2/f <sub>CLK</sub>	300		1150		1150		ns
SCKp high-level width	t <sub>KH1</sub>	2.7 V ≤ EV <sub>DD0</sub> ≤ 3.6 V, 2.3 V ≤ V <sub>b</sub> ≤ 2.7 V, C <sub>b</sub> = 20 pF, R <sub>b</sub> = 2.7 kΩ	t <sub>KCY1</sub> /2 –	120		t <sub>KCY1</sub> /2 –	120	t <sub>KCY1</sub> /2 –	120	ns
SCKp low-level width	t <sub>KL1</sub>	2.7 V ≤ EV <sub>DD0</sub> ≤ 3.6 V, 2.3 V ≤ V <sub>b</sub> ≤ 2.7 V, C <sub>b</sub> = 20 pF, R <sub>b</sub> = 2.7 kΩ	t <sub>KCY1</sub> /2 –	10		t <sub>KCY1</sub> /2 –	50	t <sub>KCY1</sub> /2 –	50	ns
Slp setup time (to SCKp↑) <sup>Note 4</sup>	t <sub>SIK1</sub>	2.7 V ≤ EV <sub>DD0</sub> ≤ 3.6 V, 2.3 V ≤ V <sub>b</sub> ≤ 2.7 V, C <sub>b</sub> = 20 pF, R <sub>b</sub> = 2.7 kΩ		121		479		479		ns
Slp hold time (from SCKp↑) <sup>Note 4</sup>	t <sub>KSI1</sub>	2.7 V ≤ EV <sub>DD0</sub> ≤ 3.6 V, 2.3 V ≤ V <sub>b</sub> ≤ 2.7 V, C <sub>b</sub> = 20 pF, R <sub>b</sub> = 2.7 kΩ		10		10		10		ns
Delay time from SCKp↓ to SO <sub>p</sub> output <sup>Note 4</sup>	t <sub>KSO1</sub>	2.7 V ≤ EV <sub>DD0</sub> ≤ 3.6 V, 2.3 V ≤ V <sub>b</sub> ≤ 2.7 V, C <sub>b</sub> = 20 pF, R <sub>b</sub> = 2.7 kΩ			130		130		130	ns
Slp setup time (to SCKp↓) <sup>Note 5</sup>	t <sub>SIK1</sub>	2.7 V ≤ EV <sub>DD0</sub> ≤ 3.6 V, 2.3 V ≤ V <sub>b</sub> ≤ 2.7 V, C <sub>b</sub> = 20 pF, R <sub>b</sub> = 2.7 kΩ		33		110		110		ns
Slp hold time (from SCKp↓) <sup>Note 5</sup>	t <sub>KSI1</sub>	2.7 V ≤ EV <sub>DD0</sub> ≤ 3.6 V, 2.3 V ≤ V <sub>b</sub> ≤ 2.7 V, C <sub>b</sub> = 20 pF, R <sub>b</sub> = 2.7 kΩ		10		10		10		ns
Delay time from SCKp↑ to SO <sub>p</sub> output <sup>Note 5</sup>	t <sub>KSO1</sub>	2.7 V ≤ EV <sub>DD0</sub> ≤ 3.6 V, 2.3 V ≤ V <sub>b</sub> ≤ 2.7 V, C <sub>b</sub> = 20 pF, R <sub>b</sub> = 2.7 kΩ			10		10		10	ns

- Notes**
1. HS is condition of HS (high-speed main) mode.
  2. LS is condition of LS (low-speed main) mode.
  3. LV is condition of LV (low-voltage main) mode.
  4. When DAP<sub>mn</sub> = 0 and CKP<sub>mn</sub> = 0, or DAP<sub>mn</sub> = 1 and CKP<sub>mn</sub> = 1.
  5. When DAP<sub>mn</sub> = 0 and CKP<sub>mn</sub> = 1, or DAP<sub>mn</sub> = 1 and CKP<sub>mn</sub> = 0.

**Caution** Select the TTL input buffer for the Slp pin and the N-ch open drain output (V<sub>DD</sub> tolerance (When 25- to 48-pin products)/EV<sub>DD</sub> tolerance (When 64-pin products)) mode for the SO<sub>p</sub> pin and SCKp pin by using port input mode register g (PIMg) and port output mode register g (POMg). For V<sub>IH</sub> and V<sub>IL</sub>, see the DC characteristics with TTL input buffer selected.

<R>

- Remarks**
1. R<sub>b</sub>[Ω]: Communication line (SCKp, SO<sub>p</sub>) pull-up resistance, C<sub>b</sub>[F]: Communication line (SCKp, SO<sub>p</sub>) load capacitance, V<sub>b</sub>[V]: Communication line voltage
  2. p: CSI number (p = 00), m: Unit number (m = 0), n: Channel number (n = 0), g: PIM and POM number (g = 1)

**(8) Communication at different potential (1.8V, 2.5 V) (CSI mode) (master mode, SCKp... internal clock output)**  
**(1/2)**

(T<sub>A</sub> = -40 to +85°C, 1.8 V ≤ EV<sub>DD0</sub> ≤ V<sub>DD</sub> ≤ 3.6 V, V<sub>SS</sub> = EV<sub>SS0</sub> = 0 V)

Parameter	Symbol	Conditions		HS <sup>Note 1</sup>		LS <sup>Note 2</sup>		LV <sup>Note 3</sup>		Unit
				MIN.	MAX.	MIN.	MAX.	MIN.	MAX.	
SCKp cycle time	t <sub>KCY1</sub>	2.7 V ≤ EV <sub>DD0</sub> ≤ 3.6 V, 2.3 V ≤ V <sub>b</sub> ≤ 2.7 V, C <sub>b</sub> = 30 pF, R <sub>b</sub> = 2.7 kΩ	t <sub>KCY1</sub> ≥ 4/f <sub>CLK</sub>	500		1150		1150		ns
		1.8 V ≤ EV <sub>DD0</sub> < 3.3 V, 1.6 V ≤ V <sub>b</sub> ≤ 2.0 V <sup>Note 4</sup> , C <sub>b</sub> = 30 pF, R <sub>b</sub> = 5.5 kΩ	t <sub>KCY1</sub> ≥ 4/f <sub>CLK</sub>	1150		1150		1150		ns
SCKp high-level width	t <sub>KH1</sub>	2.7 V ≤ EV <sub>DD0</sub> ≤ 3.6 V, 2.3 V ≤ V <sub>b</sub> ≤ 2.7 V, C <sub>b</sub> = 30 pF, R <sub>b</sub> = 2.7 kΩ		t <sub>KCY1</sub> /2 – 170		t <sub>KCY1</sub> /2 – 170		t <sub>KCY1</sub> /2 – 170		ns
		1.8 V ≤ EV <sub>DD0</sub> < 3.3 V, 1.6 V ≤ V <sub>b</sub> ≤ 2.0 V <sup>Note 4</sup> , C <sub>b</sub> = 30 pF, R <sub>b</sub> = 5.5 kΩ		t <sub>KCY1</sub> /2 – 458		t <sub>KCY1</sub> /2 – 458		t <sub>KCY1</sub> /2 – 458		ns
SCKp low-level width	t <sub>KL1</sub>	2.7 V ≤ EV <sub>DD0</sub> ≤ 3.6 V, 2.3 V ≤ V <sub>b</sub> ≤ 2.7 V, C <sub>b</sub> = 30 pF, R <sub>b</sub> = 2.7 kΩ		t <sub>KCY1</sub> /2 – 18		t <sub>KCY1</sub> /2 – 50		t <sub>KCY1</sub> /2 – 50		ns
		1.8 V ≤ EV <sub>DD0</sub> < 3.3 V, 1.6 V ≤ V <sub>b</sub> ≤ 2.0 V <sup>Note 4</sup> , C <sub>b</sub> = 30 pF, R <sub>b</sub> = 5.5 kΩ		t <sub>KCY1</sub> /2 – 50		t <sub>KCY1</sub> /2 – 50		t <sub>KCY1</sub> /2 – 50		ns

**Notes 1.** HS is condition of HS (high-speed main) mode.

**2.** LS is condition of LS (low-speed main) mode.

**3.** LV is condition of LV (low-voltage main) mode.

**4.** Use it with EV<sub>DD0</sub> ≥ V<sub>b</sub>.

**Caution** Select the TTL input buffer for the SIp pin and the N-ch open drain output (V<sub>DD</sub> tolerance (When 25- to 48-pin products)/EV<sub>DD</sub> tolerance (When 64-pin products)) mode for the SOp pin and SCKp pin by using port input mode register g (PIMg) and port output mode register g (POMg). For V<sub>IH</sub> and V<sub>IL</sub>, see the DC characteristics with TTL input buffer selected.

<R>

**Remarks 1.** R<sub>b</sub>[Ω]: Communication line (SCKp, SOp) pull-up resistance, C<sub>b</sub>[F]: Communication line (SCKp, SOp) load capacitance, V<sub>b</sub>[V]: Communication line voltage

**2.** p: CSI number (p = 00, 10, 20), m: Unit number, n: Channel number (mn = 00, 02, 10),  
g: PIM and POM number (g = 0, 1)

**3.** CSI01, CSI11, and CSI21 cannot communicate at different potential. Use other CSI for communication at different potential.

**(8) Communication at different potential (1.8 V, 2.5 V) (CSI mode) (master mode, SCKp... internal clock output) (2/2)****(T<sub>A</sub> = -40 to +85°C, 1.8 V ≤ EV<sub>DD0</sub> ≤ V<sub>DD</sub> ≤ 3.6 V, V<sub>SS</sub> = EV<sub>SS0</sub> = 0 V)**

Parameter	Symbol	Conditions	HS <sup>Note 1</sup>		LS <sup>Note 2</sup>		LV <sup>Note 3</sup>		Unit
			MIN.	MAX.	MIN.	MAX.	MIN.	MAX.	
Slp setup time (to SCKp↑) <sup>Note 4</sup>	t <sub>SIK1</sub>	2.7 V ≤ EV <sub>DD0</sub> ≤ 3.6 V, 2.3 V ≤ V <sub>b</sub> ≤ 2.7 V, C <sub>b</sub> = 30 pF, R <sub>b</sub> = 2.7 kΩ	177		479		479		ns
		1.8 V ≤ EV <sub>DD0</sub> < 3.3 V, 1.6 V ≤ V <sub>b</sub> ≤ 2.0 V <sup>Note 6</sup> , C <sub>b</sub> = 30 pF, R <sub>b</sub> = 5.5 kΩ	479		479		479		ns
Slp hold time (from SCKp↑) <sup>Note 4</sup>	t <sub>SI1</sub>	2.7 V ≤ EV <sub>DD0</sub> ≤ 3.6 V, 2.3 V ≤ V <sub>b</sub> ≤ 2.7 V, C <sub>b</sub> = 30 pF, R <sub>b</sub> = 2.7 kΩ	19		19		19		ns
		1.8 V ≤ EV <sub>DD0</sub> < 3.3 V, 1.6 V ≤ V <sub>b</sub> ≤ 2.0 V <sup>Note 6</sup> , C <sub>b</sub> = 30 pF, R <sub>b</sub> = 5.5 kΩ	19		19		19		ns
Delay time from SCKp↓ to SO <sub>p</sub> output <sup>Note 4</sup>	t <sub>KSO1</sub>	2.7 V ≤ EV <sub>DD0</sub> ≤ 3.6 V, 2.3 V ≤ V <sub>b</sub> ≤ 2.7 V, C <sub>b</sub> = 30 pF, R <sub>b</sub> = 2.7 kΩ		195		195		195	ns
		1.8 V ≤ EV <sub>DD0</sub> < 3.3 V, 1.6 V ≤ V <sub>b</sub> ≤ 2.0 V <sup>Note 6</sup> , C <sub>b</sub> = 30 pF, R <sub>b</sub> = 5.5 kΩ		483		483		483	ns
Slp setup time (to SCKp↓) <sup>Note 5</sup>	t <sub>SIK1</sub>	2.7 V ≤ EV <sub>DD0</sub> ≤ 3.6 V, 2.3 V ≤ V <sub>b</sub> ≤ 2.7 V, C <sub>b</sub> = 30 pF, R <sub>b</sub> = 2.7 kΩ	44		110		110		ns
		1.8 V ≤ EV <sub>DD0</sub> < 3.3 V, 1.6 V ≤ V <sub>b</sub> ≤ 2.0 V <sup>Note 6</sup> , C <sub>b</sub> = 30 pF, R <sub>b</sub> = 5.5 kΩ	110		110		110		ns
Slp hold time (from SCKp↓) <sup>Note 5</sup>	t <sub>SI1</sub>	2.7 V ≤ EV <sub>DD0</sub> ≤ 3.6 V, 2.3 V ≤ V <sub>b</sub> ≤ 2.7 V, C <sub>b</sub> = 30 pF, R <sub>b</sub> = 2.7 kΩ	19		19		19		ns
		1.8 V ≤ EV <sub>DD0</sub> < 3.3 V, 1.6 V ≤ V <sub>b</sub> ≤ 2.0 V <sup>Note 6</sup> , C <sub>b</sub> = 30 pF, R <sub>b</sub> = 5.5 kΩ	19		19		19		ns
Delay time from SCKp↑ to SO <sub>p</sub> output <sup>Note 5</sup>	t <sub>KSO1</sub>	2.7 V ≤ EV <sub>DD0</sub> ≤ 3.6 V, 2.3 V ≤ V <sub>b</sub> ≤ 2.7 V, C <sub>b</sub> = 30 pF, R <sub>b</sub> = 2.7 kΩ		25		25		25	ns
		1.8 V ≤ EV <sub>DD0</sub> < 3.3 V, 1.6 V ≤ V <sub>b</sub> ≤ 2.0 V <sup>Note 6</sup> , C <sub>b</sub> = 30 pF, R <sub>b</sub> = 5.5 kΩ		25		25		25	ns

- Notes 1.** HS is condition of HS (high-speed main) mode.  
**2.** LS is condition of LS (low-speed main) mode.  
**3.** LV is condition of LV (low-voltage main) mode.  
**4.** When DAP<sub>m</sub>n = 0 and CKP<sub>m</sub>n = 0, or DAP<sub>m</sub>n = 1 and CKP<sub>m</sub>n = 1.  
**5.** When DAP<sub>m</sub>n = 0 and CKP<sub>m</sub>n = 1, or DAP<sub>m</sub>n = 1 and CKP<sub>m</sub>n = 0.  
**6.** Use it with EV<sub>DD0</sub> ≥ V<sub>b</sub>.

**Caution** Select the TTL input buffer for the Slp pin and the N-ch open drain output (V<sub>DD</sub> tolerance (When 25- to 48-pin products)/EV<sub>DD</sub> tolerance (When 64-pin products)) mode for the SO<sub>p</sub> pin and SCKp pin by using port input mode register g (PIMg) and port output mode register g (POMg). For V<sub>IH</sub> and V<sub>IL</sub>, see the DC characteristics with TTL input buffer selected.

&lt;R&gt;

(Remarks are listed on the next page.)

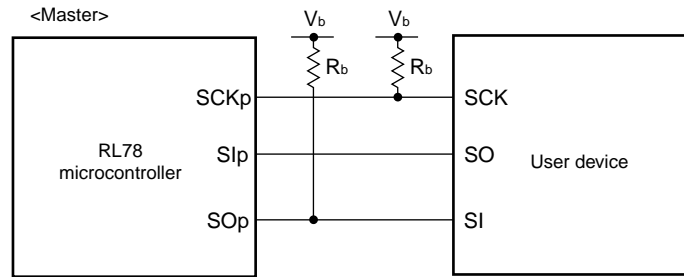
**CSI mode connection diagram (during communication at different potential)**

- Remarks 1.**  $R_b[\Omega]$ : Communication line (SCKp, SOp) pull-up resistance,  $C_b[\text{F}]$ : Communication line (SCKp, SOp) load capacitance,  $V_b[\text{V}]$ : Communication line voltage
- 2.** p: CSI number (p = 00, 10, 20), m: Unit number, n: Channel number (mn = 00, 02, 10), g: PIM and POM number (g = 0, 1)
- 3.** CSI01, CSI11, and CSI21 cannot communicate at different potential. Use other CSI for communication at different potential.

**CSI mode serial transfer timing (master mode) (during communication at different potential)  
(When DAPmn = 0 and CKPmn = 0, or DAPmn = 1 and CKPmn = 1.)**

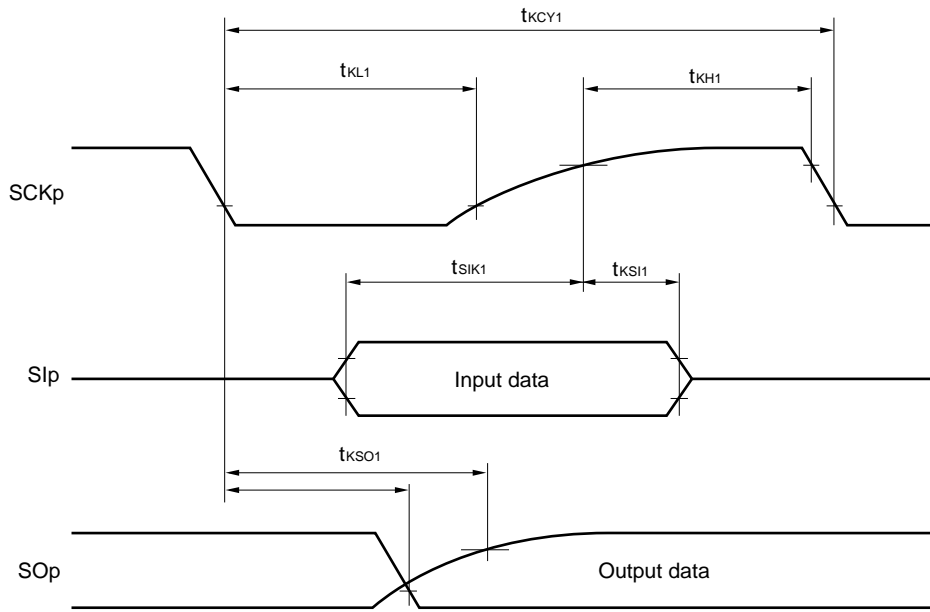

**CSI mode serial transfer timing (master mode) (during communication at different potential)  
(When DAPmn = 0 and CKPmn = 1, or DAPmn = 1 and CKPmn = 0.)**

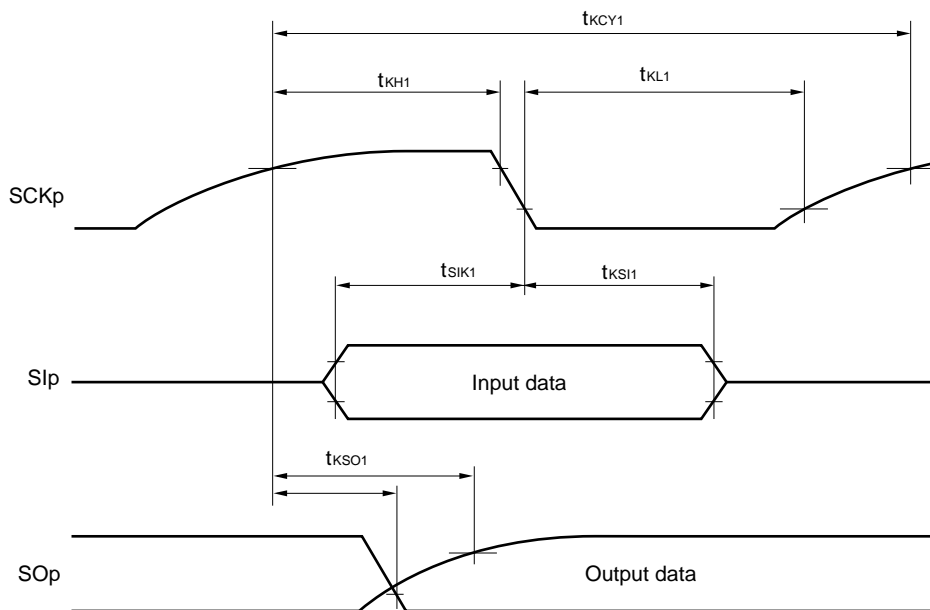

- Remarks**
1. p: CSI number (p = 00, 10, 20), m: Unit number, n: Channel number (m = 00, 02, 10), g: PIM and POM number (g = 0, 1)
  2. CSI01, CSI11, and CSI21 cannot communicate at different potential. Use other CSI for communication at different potential.

**(9) Communication at different potential (1.8 V, 2.5 V) (CSI mode) (slave mode, SCKp... external clock input)**  
**(T<sub>A</sub> = -40 to +85°C, 1.8 V ≤ EV<sub>DD0</sub> ≤ V<sub>DD</sub> ≤ 3.6 V, V<sub>SS</sub> = EV<sub>SS0</sub> = 0 V)**

Parameter	Symbol	Conditions	HS <sup>Note 1</sup>		LS <sup>Note 2</sup>		LV <sup>Note 3</sup>		Unit
			MIN.	MAX.	MIN.	MAX.	MIN.	MAX.	
SCKp cycle time <sup>Note 4</sup>	t <sub>KCY2</sub>	2.7 V ≤ EV <sub>DD0</sub> ≤ 3.6 V, 2.3 V ≤ V <sub>b</sub> ≤ 2.7 V	24 MHz < f <sub>MCK</sub>	20/f <sub>MCK</sub>		–		–	ns
			20 MHz < f <sub>MCK</sub> ≤ 24 MHz	16/f <sub>MCK</sub>		–		–	ns
			16 MHz < f <sub>MCK</sub> ≤ 20 MHz	14/f <sub>MCK</sub>		–		–	ns
			8 MHz < f <sub>MCK</sub> ≤ 16 MHz	12/f <sub>MCK</sub>		–		–	ns
			4 MHz < f <sub>MCK</sub> ≤ 8 MHz	8/f <sub>MCK</sub>		16/f <sub>MCK</sub>		–	ns
			f <sub>MCK</sub> ≤ 4 MHz	6/f <sub>MCK</sub>		10/f <sub>MCK</sub>		10/f <sub>MCK</sub>	ns
		1.8 V ≤ EV <sub>DD0</sub> < 3.3 V, 1.6 V ≤ V <sub>b</sub> ≤ 2.0 V <sup>Note 5</sup>	24 MHz < f <sub>MCK</sub>	48/f <sub>MCK</sub>		–		–	ns
			20 MHz < f <sub>MCK</sub> ≤ 24 MHz	36/f <sub>MCK</sub>		–		–	ns
			16 MHz < f <sub>MCK</sub> ≤ 20 MHz	32/f <sub>MCK</sub>		–		–	ns
			8 MHz < f <sub>MCK</sub> ≤ 16 MHz	26/f <sub>MCK</sub>		–		–	ns
			4 MHz < f <sub>MCK</sub> ≤ 8 MHz	16/f <sub>MCK</sub>		16/f <sub>MCK</sub>		–	ns
f <sub>MCK</sub> ≤ 4 MHz	10/f <sub>MCK</sub>		10/f <sub>MCK</sub>		10/f <sub>MCK</sub>	ns			
SCKp high-/low-level width	t <sub>KH2</sub> , t <sub>KL2</sub>	2.7 V ≤ EV <sub>DD0</sub> ≤ 3.6 V, 2.3 V ≤ V <sub>b</sub> ≤ 2.7 V	t <sub>KCY2</sub> /2 – 18		t <sub>KCY2</sub> /2 – 50		t <sub>KCY2</sub> /2 – 50	ns	
		1.8 V ≤ EV <sub>DD0</sub> < 3.3 V, 1.6 V ≤ V <sub>b</sub> ≤ 2.0 V <sup>Note 5</sup>	t <sub>KCY2</sub> /2 – 50		t <sub>KCY2</sub> /2 – 50		t <sub>KCY2</sub> /2 – 50	ns	
Slp setup time (to SCKp↑) <sup>Note 6</sup>	t <sub>SIK2</sub>	2.7 V ≤ EV <sub>DD0</sub> ≤ 3.6 V, 2.3 V ≤ V <sub>b</sub> ≤ 2.7 V	1/f <sub>MCK</sub> + 20		1/f <sub>MCK</sub> + 30		1/f <sub>MCK</sub> + 30	ns	
		1.8 V ≤ EV <sub>DD0</sub> < 3.3 V, 1.6 V ≤ V <sub>b</sub> ≤ 2.0 V <sup>Note 5</sup>	1/f <sub>MCK</sub> + 30		1/f <sub>MCK</sub> + 30		1/f <sub>MCK</sub> + 30	ns	
Slp hold time (from SCKp↑) <sup>Note 6</sup>	t <sub>SIH2</sub>		1/f <sub>MCK</sub> + 31		1/f <sub>MCK</sub> + 31		1/f <sub>MCK</sub> + 31	ns	
Delay time from SCKp↓ to SOp output <sup>Note 7</sup>	t <sub>KSO2</sub>	2.7 V ≤ EV <sub>DD0</sub> ≤ 3.6 V, 2.3 V ≤ V <sub>b</sub> ≤ 2.7 V, C <sub>b</sub> = 30 pF, R <sub>b</sub> = 2.7 kΩ		2/f <sub>MCK</sub> + 214		2/f <sub>MCK</sub> + 573		2/f <sub>MCK</sub> + 573	ns
		1.8 V ≤ EV <sub>DD0</sub> < 3.3 V, 1.6 V ≤ V <sub>b</sub> ≤ 2.0 V <sup>Note 5</sup> , C <sub>b</sub> = 30 pF, R <sub>b</sub> = 5.5 kΩ		2/f <sub>MCK</sub> + 573		2/f <sub>MCK</sub> + 573		2/f <sub>MCK</sub> + 573	ns

**Notes 1.** HS is condition of HS (high-speed main) mode.

**2.** LS is condition of LS (low-speed main) mode.

**3.** LV is condition of LV (low-voltage main) mode.

**4.** Transfer rate in the SNOOZE mode : MAX. 1 Mbps

**5.** Use it with EV<sub>DD0</sub> ≥ V<sub>b</sub>.

**6.** When DAP<sub>mn</sub> = 0 and CKP<sub>mn</sub> = 0, or DAP<sub>mn</sub> = 1 and CKP<sub>mn</sub> = 1. The Slp setup time or Slp hold time becomes “from SCKp↓” when DAP<sub>mn</sub> = 0 and CKP<sub>mn</sub> = 1, or DAP<sub>mn</sub> = 1 and CKP<sub>mn</sub> = 0.

**7.** When DAP<sub>mn</sub> = 0 and CKP<sub>mn</sub> = 0, or DAP<sub>mn</sub> = 1 and CKP<sub>mn</sub> = 1. The delay time to SOp output becomes “from SCKp↑” when DAP<sub>mn</sub> = 0 and CKP<sub>mn</sub> = 1, or DAP<sub>mn</sub> = 1 and CKP<sub>mn</sub> = 0.

**Caution** Select the TTL input buffer for the Slp pin and SCKp pin and the N-ch open drain output (V<sub>DD</sub> tolerance (When 25- to 48-pin products)/EV<sub>DD</sub> tolerance (When 64-pin products)) mode for the SOp pin by using port input mode register g (PIMg) and port output mode register g (POMg). For V<sub>IH</sub> and V<sub>IL</sub>, see the DC characteristics with TTL input buffer selected.

<R>

(Remarks are listed on the next page.)

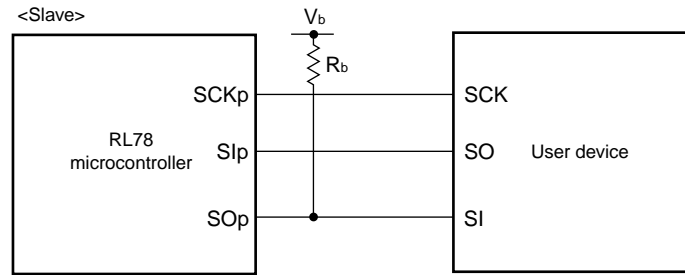
**CSI mode connection diagram (during communication at different potential)**

- Remarks**
1.  $R_b[\Omega]$ : Communication line (SO<sub>p</sub>) pull-up resistance,  $C_b[\text{F}]$ : Communication line (SO<sub>p</sub>) load capacitance,  $V_b[\text{V}]$ : Communication line voltage
  2. p: CSI number (p = 00, 10, 20), m: Unit number (m = 0, 1), n: Channel number (n = 00, 02, 10), g: PIM and POM number (g = 0, 1)
  3.  $f_{\text{mck}}$ : Serial array unit operation clock frequency  
(Operation clock to be set by the CKSmn bit of serial mode register mn (SMRmn).  
m: Unit number, n: Channel number (mn = 00, 02, 10))
  4. CSI01, CSI11, and CSI21 cannot communicate at different potential. Use other CSI for communication at different potential.



**CSI mode serial transfer timing (slave mode) (during communication at different potential)  
(When DAPmn = 0 and CKPmn = 0, or DAPmn = 1 and CKPmn = 1.)**

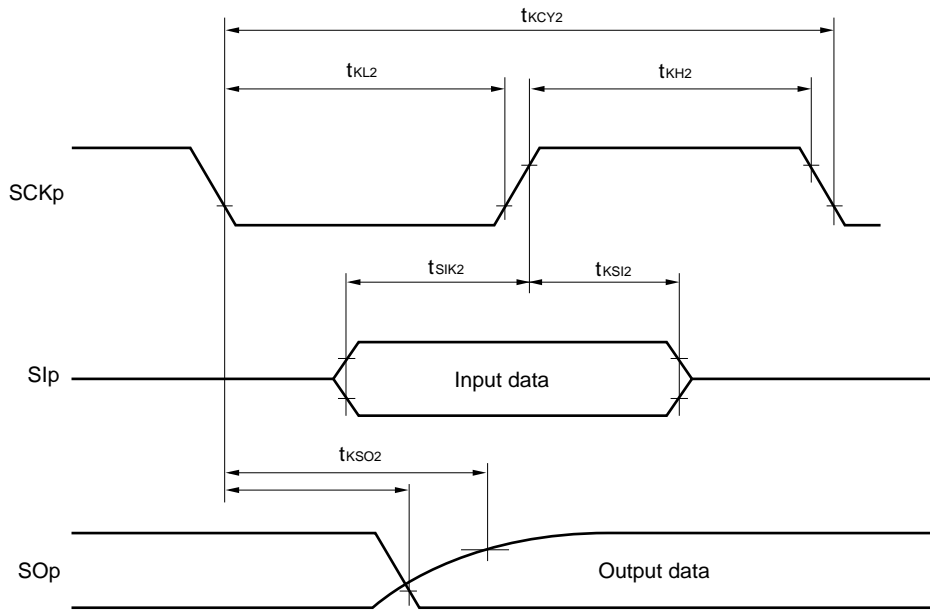

**CSI mode serial transfer timing (slave mode) (during communication at different potential)  
(When DAPmn = 0 and CKPmn = 1, or DAPmn = 1 and CKPmn = 0.)**

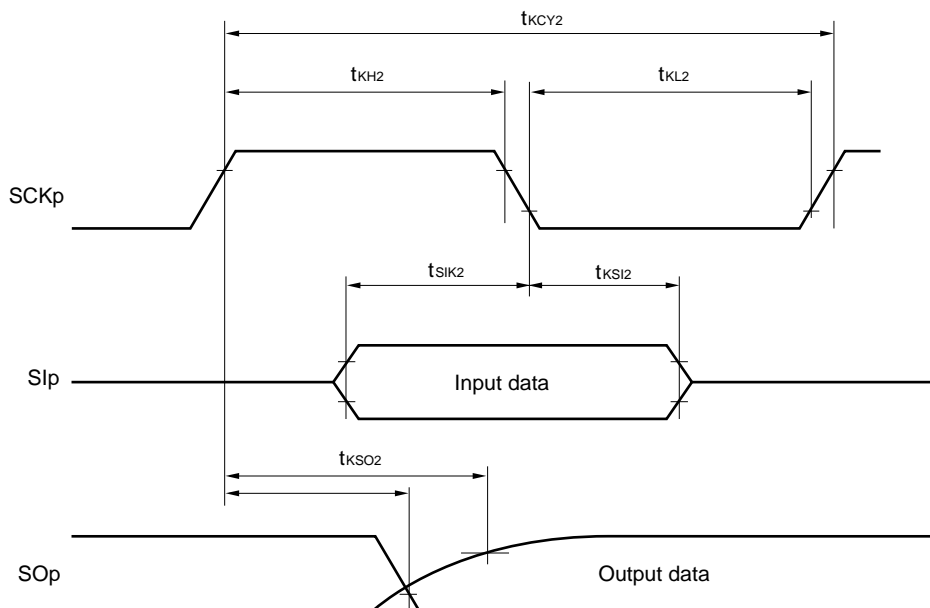

- Remarks 1.** p: CSI number (p = 00, 10, 20), m: Unit number, n: Channel number (mn = 00, 02, 10), g: PIM and POM number (g = 0, 1)
- 2.** CSI01, CSI11, and CSI21 cannot communicate at different potential. Use other CSI for communication at different potential.

**(10) Communication at different potential (1.8 V, 2.5 V) (simplified I<sup>2</sup>C mode) (1/2)****(T<sub>A</sub> = -40 to +85°C, 1.8 V ≤ EV<sub>DD0</sub> ≤ V<sub>DD</sub> ≤ 3.6 V, V<sub>SS</sub> = EV<sub>SS0</sub> = 0 V)**

Parameter	Symbol	Conditions	HS <sup>Note 1</sup>		LS <sup>Note 2</sup>		LV <sup>Note 3</sup>		Unit
			MIN.	MAX.	MIN.	MAX.	MIN.	MAX.	
SCLr clock frequency	f <sub>SCL</sub>	2.7 V ≤ EV <sub>DD0</sub> ≤ 3.6 V, 2.3 V ≤ V <sub>b</sub> ≤ 2.7 V, C <sub>b</sub> = 50 pF, R <sub>b</sub> = 2.7 kΩ		1000 <sup>Note 4</sup>		300 <sup>Note 4</sup>		300 <sup>Note 4</sup>	kHz
		2.7 V ≤ EV <sub>DD0</sub> ≤ 3.6 V, 2.3 V ≤ V <sub>b</sub> ≤ 2.7 V, C <sub>b</sub> = 100 pF, R <sub>b</sub> = 2.7 kΩ		400 <sup>Note 4</sup>		300 <sup>Note 4</sup>		300 <sup>Note 4</sup>	kHz
		1.8 V ≤ EV <sub>DD0</sub> < 3.3 V, 1.6 V ≤ V <sub>b</sub> ≤ 2.0 V <sup>Note 5</sup> , C <sub>b</sub> = 100 pF, R <sub>b</sub> = 5.5 kΩ		300 <sup>Note 4</sup>		300 <sup>Note 4</sup>		300 <sup>Note 4</sup>	kHz
Hold time when SCLr = "L"	t <sub>LOW</sub>	2.7 V ≤ EV <sub>DD0</sub> ≤ 3.6 V, 2.3 V ≤ V <sub>b</sub> ≤ 2.7 V, C <sub>b</sub> = 50 pF, R <sub>b</sub> = 2.7 kΩ	475		1550		1550		ns
		2.7 V ≤ EV <sub>DD0</sub> ≤ 3.6 V, 2.3 V ≤ V <sub>b</sub> ≤ 2.7 V, C <sub>b</sub> = 100 pF, R <sub>b</sub> = 2.7 kΩ	1150		1550		1550		ns
		1.8 V ≤ EV <sub>DD0</sub> < 3.3 V, 1.6 V ≤ V <sub>b</sub> ≤ 2.0 V <sup>Note 5</sup> , C <sub>b</sub> = 100 pF, R <sub>b</sub> = 5.5 kΩ	1550		1550		1550		ns
Hold time when SCLr = "H"	t <sub>HIGH</sub>	2.7 V ≤ EV <sub>DD0</sub> ≤ 3.6 V, 2.3 V ≤ V <sub>b</sub> ≤ 2.7 V, C <sub>b</sub> = 50 pF, R <sub>b</sub> = 2.7 kΩ	200		610		610		ns
		2.7 V ≤ EV <sub>DD0</sub> ≤ 3.6 V, 2.3 V ≤ V <sub>b</sub> ≤ 2.7 V, C <sub>b</sub> = 100 pF, R <sub>b</sub> = 2.7 kΩ	600		610		610		ns
		1.8 V ≤ EV <sub>DD0</sub> < 3.3 V, 1.6 V ≤ V <sub>b</sub> ≤ 2.0 V <sup>Note 5</sup> , C <sub>b</sub> = 100 pF, R <sub>b</sub> = 5.5 kΩ	610		610		610		ns

(Notes, Caution and Remarks are listed on the next page.)

**(10) Communication at different potential (1.8 V, 2.5 V) (simplified I<sup>2</sup>C mode) (2/2)****(T<sub>A</sub> = -40 to +85°C, 1.8 V ≤ EV<sub>DD0</sub> ≤ V<sub>DD</sub> ≤ 3.6 V, V<sub>SS</sub> = EV<sub>SS0</sub> = 0 V)**

Parameter	Symbol	Conditions	HS <sup>Note 1</sup>		LS <sup>Note 2</sup>		LV <sup>Note 3</sup>		Unit
			MIN.	MAX.	MIN.	MAX.	MIN.	MAX.	
Data setup time (reception)	t <sub>SU:DAT</sub>	2.7 V ≤ EV <sub>DD0</sub> ≤ 3.6 V, 2.3 V ≤ V <sub>b</sub> ≤ 2.7 V, C <sub>b</sub> = 50 pF, R <sub>b</sub> = 2.7 kΩ	1/f <sub>MCK</sub> + 135 <sup>Note 6</sup>		1/f <sub>MCK</sub> + 190 <sup>Note 6</sup>		1/f <sub>MCK</sub> + 190 <sup>Note 6</sup>		ns
		2.7 V ≤ EV <sub>DD0</sub> ≤ 3.6 V, 2.3 V ≤ V <sub>b</sub> ≤ 2.7 V, C <sub>b</sub> = 100 pF, R <sub>b</sub> = 2.7 kΩ	1/f <sub>MCK</sub> + 190 <sup>Note 6</sup>		1/f <sub>MCK</sub> + 190 <sup>Note 6</sup>		1/f <sub>MCK</sub> + 190 <sup>Note 6</sup>		ns
		1.8 V ≤ EV <sub>DD0</sub> < 3.3 V, 1.6 V ≤ V <sub>b</sub> ≤ 2.0 V <sup>Note 5</sup> , C <sub>b</sub> = 100 pF, R <sub>b</sub> = 5.5 kΩ	1/f <sub>MCK</sub> + 190 <sup>Note 6</sup>		1/f <sub>MCK</sub> + 190 <sup>Note 6</sup>		1/f <sub>MCK</sub> + 190 <sup>Note 6</sup>		ns
Data hold time (transmission)	t <sub>HD:DAT</sub>	2.7 V ≤ EV <sub>DD0</sub> ≤ 3.6 V, 2.3 V ≤ V <sub>b</sub> ≤ 2.7 V, C <sub>b</sub> = 50 pF, R <sub>b</sub> = 2.7 kΩ	0	305	0	305	0	305	ns
		2.7 V ≤ EV <sub>DD0</sub> ≤ 3.6 V, 2.3 V ≤ V <sub>b</sub> ≤ 2.7 V, C <sub>b</sub> = 100 pF, R <sub>b</sub> = 2.7 kΩ	0	355	0	355	0	355	ns
		1.8 V ≤ EV <sub>DD0</sub> < 3.3 V, 1.6 V ≤ V <sub>b</sub> ≤ 2.0 V <sup>Note 5</sup> , C <sub>b</sub> = 100 pF, R <sub>b</sub> = 5.5 kΩ	0	405	0	405	0	405	ns

- Notes 1.** HS is condition of HS (high-speed main) mode.  
**2.** LS is condition of LS (low-speed main) mode.  
**3.** LV is condition of LV (low-voltage main) mode.  
**4.** The value must also be f<sub>CLK</sub>/4 or lower.  
**5.** Use it with EV<sub>DD0</sub> ≥ V<sub>b</sub>.  
**6.** Set the f<sub>MCK</sub> value to keep the hold time of SCLr = "L" and SCLr = "H".

**Caution** Select the TTL input buffer and the N-ch open drain output (V<sub>DD</sub> tolerance (When 25- to 48-pin products)/EV<sub>DD</sub> tolerance (When 64-pin products)) mode for the SDAr pin and the N-ch open drain output (V<sub>DD</sub> tolerance (When 25- to 48-pin products)/EV<sub>DD</sub> tolerance (When 64-pin products)) mode for the SCLr pin by using port input mode register g (PIMg) and port output mode register g (POMg). For V<sub>IH</sub> and V<sub>IL</sub>, see the DC characteristics with TTL input buffer selected.

&lt;R&gt;

(Remarks are listed on the next page.)

**Simplified I<sup>2</sup>C mode connection diagram (during communication at different potential)**

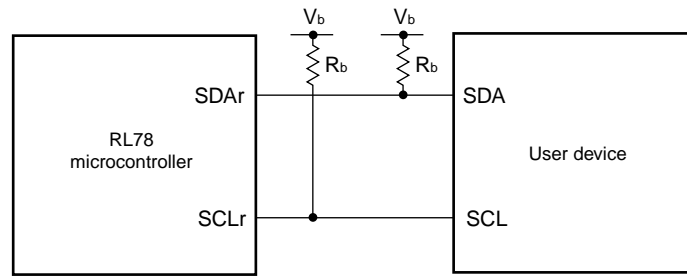

**Simplified I<sup>2</sup>C mode serial transfer timing (during communication at different potential)**

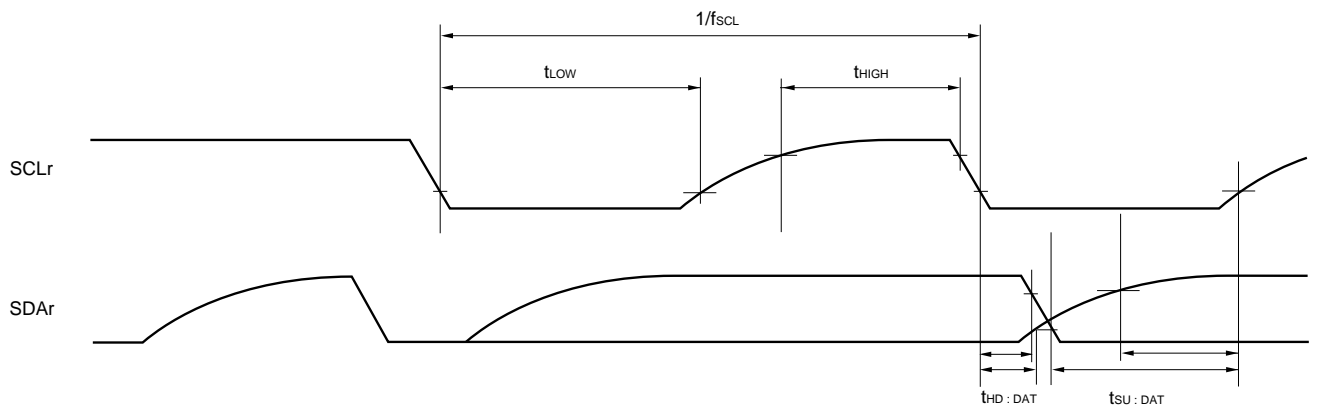

- Remarks**
1. R<sub>b</sub>[Ω]: Communication line (SDAr, SCLr) pull-up resistance, C<sub>b</sub>[F]: Communication line (SDAr, SCLr) load capacitance, V<sub>b</sub>[V]: Communication line voltage
  2. r: IIC number (r = 00, 10, 20), g: PIM, POM number (g = 0, 1)
  3. f<sub>MCK</sub>: Serial array unit operation clock frequency  
(Operation clock to be set by the CKSmn bit of serial mode register mn (SMRmn). m: Unit number, n: Channel number (mn = 00, 02, 10))
  4. IIC01, IIC11, and IIC21 cannot communicate at different potential. Use IIC00, IIC10, or IIC20 for communication at different potential.

## 2.5.2 Serial interface IICA

(1) I<sup>2</sup>C standard mode(T<sub>A</sub> = -40 to +85°C, 1.6 V ≤ EV<sub>DD0</sub> ≤ V<sub>DD</sub> ≤ 3.6 V, V<sub>SS</sub> = EV<sub>SS0</sub> = 0 V)

Parameter	Symbol	Conditions	Standard Mode <sup>Note 1</sup>						Unit
			HS <sup>Note 2</sup>		LS <sup>Note 3</sup>		LV <sup>Note 4</sup>		
			MIN.	MAX.	MIN.	MIN.	MAX.	MIN.	
SCLA0 clock frequency	f <sub>SCL</sub>	2.7 V ≤ EV <sub>DD0</sub> ≤ 3.6 V	0	100	0	100	0	100	kHz
		1.8 V ≤ EV <sub>DD0</sub> ≤ 3.6 V	0	100	0	100	0	100	
		1.7 V ≤ EV <sub>DD0</sub> ≤ 3.6 V	0	100	0	100	0	100	
		1.6 V ≤ EV <sub>DD0</sub> ≤ 3.6 V	–		0	100	0	100	
Setup time of restart condition	t <sub>SU:STA</sub>	2.7 V ≤ EV <sub>DD0</sub> ≤ 3.6 V	4.7		4.7		4.7		μs
		1.8 V ≤ EV <sub>DD0</sub> ≤ 3.6 V	4.7		4.7		4.7		
		1.7 V ≤ EV <sub>DD0</sub> ≤ 3.6 V	4.7		4.7		4.7		
		1.6 V ≤ EV <sub>DD0</sub> ≤ 3.6 V	–		4.7		4.7		
Hold time <sup>Note 5</sup>	t <sub>HD:STA</sub>	2.7 V ≤ EV <sub>DD0</sub> ≤ 3.6 V	4.0		4.0		4.0		μs
		1.8 V ≤ EV <sub>DD0</sub> ≤ 3.6 V	4.0		4.0		4.0		
		1.7 V ≤ EV <sub>DD0</sub> ≤ 3.6 V	4.0		4.0		4.0		
		1.6 V ≤ EV <sub>DD0</sub> ≤ 3.6 V	–		4.0		4.0		
Hold time when SCLA0 = "L"	t <sub>LOW</sub>	2.7 V ≤ EV <sub>DD0</sub> ≤ 3.6 V	4.7		4.7		4.7		μs
		1.8 V ≤ EV <sub>DD0</sub> ≤ 3.6 V	4.7		4.7		4.7		
		1.7 V ≤ EV <sub>DD0</sub> ≤ 3.6 V	4.7		4.7		4.7		
		1.6 V ≤ EV <sub>DD0</sub> ≤ 3.6 V	–		4.7		4.7		
Hold time when SCLA0 = "H"	t <sub>HIGH</sub>	2.7 V ≤ EV <sub>DD0</sub> ≤ 3.6 V	4.0		4.0		4.0		μs
		1.8 V ≤ EV <sub>DD0</sub> ≤ 3.6 V	4.0		4.0		4.0		
		1.7 V ≤ EV <sub>DD0</sub> ≤ 3.6 V	4.0		4.0		4.0		
		1.6 V ≤ EV <sub>DD0</sub> ≤ 3.6 V	–		4.0		4.0		
Data setup time (reception)	t <sub>SU:DAT</sub>	2.7 V ≤ EV <sub>DD0</sub> ≤ 3.6 V	250		250		250		ns
		1.8 V ≤ EV <sub>DD0</sub> ≤ 3.6 V	250		250		250		
		1.7 V ≤ EV <sub>DD0</sub> ≤ 3.6 V	250		250		250		
		1.6 V ≤ EV <sub>DD0</sub> ≤ 3.6 V	–		250		250		
Data hold time (transmission) <sup>Note 6</sup>	t <sub>HD:DAT</sub>	2.7 V ≤ EV <sub>DD0</sub> ≤ 3.6 V	0	3.45	0	3.45	0	3.45	μs
		1.8 V ≤ EV <sub>DD0</sub> ≤ 3.6 V	0	3.45	0	3.45	0	3.45	
		1.7 V ≤ EV <sub>DD0</sub> ≤ 3.6 V	0	3.45	0	3.45	0	3.45	
		1.6 V ≤ EV <sub>DD0</sub> ≤ 3.6 V	–	–	0	3.45	0	3.45	
Setup time of stop condition	t <sub>SU:STO</sub>	2.7 V ≤ EV <sub>DD0</sub> ≤ 3.6 V	4.0		4.0		4.0		μs
		1.8 V ≤ EV <sub>DD0</sub> ≤ 3.6 V	4.0		4.0		4.0		
		1.7 V ≤ EV <sub>DD0</sub> ≤ 3.6 V	4.0		4.0		4.0		
		1.6 V ≤ EV <sub>DD0</sub> ≤ 3.6 V	–		4.0		4.0		
Bus-free time	t <sub>BUF</sub>	2.7 V ≤ EV <sub>DD0</sub> ≤ 3.6 V	4.7		4.7		4.7		μs
		1.8 V ≤ EV <sub>DD0</sub> ≤ 3.6 V	4.7		4.7		4.7		
		1.7 V ≤ EV <sub>DD0</sub> ≤ 3.6 V	4.7		4.7		4.7		
		1.6 V ≤ EV <sub>DD0</sub> ≤ 3.6 V	–		4.7		4.7		

(Note and Remark are listed on the next page.)

(2) I<sup>2</sup>C fast mode, fast mode plus(T<sub>A</sub> = -40 to +85°C, 1.6 V ≤ EV<sub>DD0</sub> ≤ V<sub>DD</sub> ≤ 3.6 V, V<sub>SS</sub> = EV<sub>SS0</sub> = 0 V)

Parameter	Symbol	Conditions	Fast Mode <sup>Note 7</sup>						Fast Mode Plus <sup>Note 8</sup>		Unit
			HS <sup>Note 2</sup>		LS <sup>Note 3</sup>		LV <sup>Note 4</sup>		HS <sup>Note 2</sup>		
			MIN.	MAX.	MIN.	MIN.	MAX.	MIN.	MAX.	MIN.	
SCLA0 clock frequency	f <sub>SCL</sub>	2.7 V ≤ EV <sub>DD0</sub> ≤ 3.6 V	0	400	0	400	0	400	0	1000	kHz
		1.8 V ≤ EV <sub>DD0</sub> ≤ 3.6 V	0	400	0	400	0	400	–		
Setup time of restart condition	t <sub>SU:STA</sub>	2.7 V ≤ EV <sub>DD0</sub> ≤ 3.6 V	0.6		0.6		0.6		0.26		μs
		1.8 V ≤ EV <sub>DD0</sub> ≤ 3.6 V	0.6		0.6		0.6		–		
Hold time <sup>Note 5</sup>	t <sub>HD:STA</sub>	2.7 V ≤ EV <sub>DD0</sub> ≤ 3.6 V	0.6		0.6		0.6		0.26		μs
		1.8 V ≤ EV <sub>DD0</sub> ≤ 3.6 V	0.6		0.6		0.6		–		
Hold time when SCLA0 = "L"	t <sub>LOW</sub>	2.7 V ≤ EV <sub>DD0</sub> ≤ 3.6 V	1.3		1.3		1.3		0.5		μs
		1.8 V ≤ EV <sub>DD0</sub> ≤ 3.6 V	1.3		1.3		1.3		–		
Hold time when SCLA0 = "H"	t <sub>HIGH</sub>	2.7 V ≤ EV <sub>DD0</sub> ≤ 3.6 V	0.6		0.6		0.6		0.26		μs
		1.8 V ≤ EV <sub>DD0</sub> ≤ 3.6 V	0.6		0.6		0.6		–		
Data setup time (reception)	t <sub>SU:DAT</sub>	2.7 V ≤ EV <sub>DD0</sub> ≤ 3.6 V	100		100		100		50		ns
		1.8 V ≤ EV <sub>DD0</sub> ≤ 3.6 V	100		100		100		–		
Data hold time (transmission) <sup>Note 6</sup>	t <sub>HD:DAT</sub>	2.7 V ≤ EV <sub>DD0</sub> ≤ 3.6 V	0	0.9	0	0.9	0	0.9	0	450	μs
		1.8 V ≤ EV <sub>DD0</sub> ≤ 3.6 V	0	0.9	0	0.9	0	0.9	–		
Setup time of stop condition	t <sub>SU:STO</sub>	2.7 V ≤ EV <sub>DD0</sub> ≤ 3.6 V	0.6		0.6		0.6		0.26		μs
		1.8 V ≤ EV <sub>DD0</sub> ≤ 3.6 V	0.6		0.6		0.6		–		
Bus-free time	t <sub>BUF</sub>	2.7 V ≤ EV <sub>DD0</sub> ≤ 3.6 V	1.3		1.3		1.3		0.5		μs
		1.8 V ≤ EV <sub>DD0</sub> ≤ 3.6 V	1.3		1.3		1.3		–		

- Notes**
1. In normal mode, use it with f<sub>CLK</sub> ≥ 1 MHz, 1.6 V ≤ EV<sub>DD</sub> ≤ 3.6 V.
  2. HS is condition of HS (high-speed main) mode.
  3. LS is condition of LS (low-speed main) mode.
  4. LV is condition of LV (low-voltage main) mode.
  5. The first clock pulse is generated after this period when the start/restart condition is detected.
  6. The maximum value (MAX.) of t<sub>HD:DAT</sub> is during normal transfer and a wait state is inserted in the ACK (acknowledge) timing.
  7. In fast mode, use it with f<sub>CLK</sub> ≥ 3.5 MHz, 1.8 V ≤ EV<sub>DD</sub> ≤ 3.6 V.
  8. In fast mode plus, use it with f<sub>CLK</sub> ≥ 10 MHz, 2.7 V ≤ EV<sub>DD</sub> ≤ 3.6 V.

**Remark** The maximum value of C<sub>b</sub> (communication line capacitance) and the value of R<sub>b</sub> (communication line pull-up resistor) at that time in each mode are as follows.

Standard mode: C<sub>b</sub> = 400 pF, R<sub>b</sub> = 2.7 kΩ

Fast mode: C<sub>b</sub> = 320 pF, R<sub>b</sub> = 1.1 kΩ

Fast mode plus: C<sub>b</sub> = 120 pF, R<sub>b</sub> = 1.1 kΩ

IICA serial transfer timing

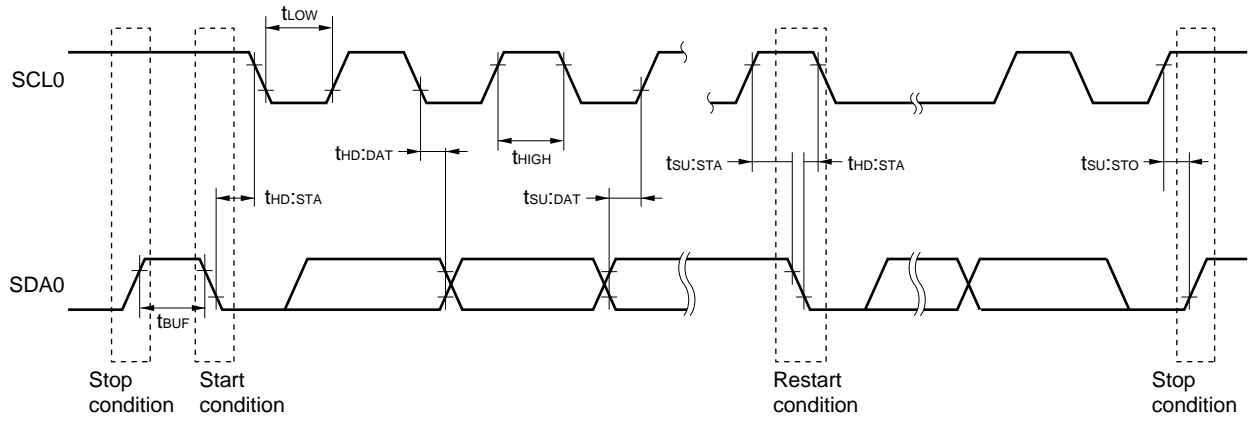

## 2.6 Analog Characteristics

### 2.6.1 A/D converter characteristics

**Division of A/D Converter Characteristics**

Reference voltage Input channel	Reference voltage (+) = AV <sub>REFP</sub> Reference voltage (-) = AV <sub>REFM</sub>	Reference voltage (+) = AV <sub>DD</sub> Reference voltage (-) = AV <sub>SS</sub>	Reference voltage (+) = Internal reference voltage Reference voltage (-) = AV <sub>SS</sub>
High-accuracy channel; ANI0 to ANI12 (input buffer power supply: AV <sub>DD</sub> )	See 2.6.1 (1) See 2.6.1 (2)	See 2.6.1 (3)	See 2.6.1 (6)
Standard channel; ANI16 to ANI30 (input buffer power supply: V <sub>DD</sub> or EV <sub>DD0</sub> )	See 2.6.1 (4)	See 2.6.1 (5)	
Temperature sensor, internal reference voltage output	See 2.6.1 (4)	See 2.6.1 (5)	–

<R> (1) When reference voltage (+) = AV<sub>REFP</sub>/ANI0 (ADREFP1 = 0, ADREFP0 = 1), reference voltage (-) = AV<sub>REFM</sub>/ANI1 (ADREFM = 1), target for conversion: ANI2 to ANI12

<R> (T<sub>A</sub> = -40 to +85°C, 2.4 V ≤ AV<sub>REFP</sub> ≤ AV<sub>DD</sub> ≤ V<sub>DD</sub> ≤ 3.6 V, V<sub>SS</sub> = 0 V, AV<sub>SS</sub> = 0 V, Reference voltage (+) = AV<sub>REFP</sub>, Reference voltage (-) = AV<sub>REFM</sub> = 0 V, HALT mode)

Parameter	Symbol	Conditions	MIN.	TYP.	MAX.	Unit
Resolution	R <sub>ES</sub>				12	bit
Overall error <sup>Notes 1, 2, 3</sup>	A <sub>INL</sub>	12-bit resolution		±1.7	±3.3	LSB
Conversion time	t <sub>CONV</sub>	ADTYP = 0, 12-bit resolution	3.375			μs
Zero-scale error <sup>Notes 1, 2, 3</sup>	E <sub>ZS</sub>	12-bit resolution		±1.3	±3.2	LSB
Full-scale error <sup>Notes 1, 2, 3</sup>	E <sub>FS</sub>	12-bit resolution		±0.7	±2.9	LSB
Integral linearity error <sup>Notes 1, 2, 3</sup>	I <sub>LE</sub>	12-bit resolution		±1.0	±1.4	LSB
Differential linearity error <sup>Notes 1, 2, 3</sup>	D <sub>LE</sub>	12-bit resolution		±0.9	±1.2	LSB
Analog input voltage	V <sub>AIN</sub>		0		AV <sub>REFP</sub>	V

**Notes** 1. TYP. Value is the average value at AV<sub>DD</sub> = AV<sub>REFP</sub> = 3 V and T<sub>A</sub> = 25°C. MAX. value is the average value ±3σ at normalized distribution.

2. These values are the results of characteristic evaluation and are not checked for shipment.

3. Excludes quantization error (±1/2 LSB).

**Cautions** 1. Route the wiring so that noise will not be superimposed on each power line and ground line, and insert a capacitor to suppress noise.

In addition, separate the reference voltage line of AV<sub>REFP</sub> from the other power lines to keep it free from the influences of noise.

2. During A/D conversion, keep a pulse, such as a digital signal, that abruptly changes its level from being input to or output from the pins adjacent to the converter pins and P20 to P27 and P150 to P154.



<R> (2) When reference voltage (+) = AV<sub>REFP</sub>/ANI0 (ADREFP1 = 0, ADREFP0 = 1), reference voltage (-) = AV<sub>REFM</sub>/ANI1 (ADREFM = 1), target for conversion: ANI2 to ANI12

(T<sub>A</sub> = -40 to +85°C, 1.6 V ≤ AV<sub>REFP</sub> ≤ AV<sub>DD</sub> ≤ V<sub>DD</sub> ≤ 3.6 V, V<sub>SS</sub> = 0 V, AV<sub>SS</sub> = 0 V, Reference voltage (+) = AV<sub>REFP</sub>, Reference voltage (-) = AV<sub>REFM</sub> = 0 V)

Parameter	Symbol	Conditions	MIN.	TYP.	MAX.	Unit
Resolution	RES	2.4 V ≤ AV <sub>REFP</sub> ≤ AV <sub>DD</sub> ≤ 3.6 V	8		12	bit
		1.8 V ≤ AV <sub>REFP</sub> ≤ AV <sub>DD</sub> ≤ 3.6 V	8		10 <sup>Note 1</sup>	
		1.6 V ≤ AV <sub>REFP</sub> ≤ AV <sub>DD</sub> ≤ 3.6 V	g <sup>Note 2</sup>			
Overall error <sup>Note 3</sup>	AINL	12-bit resolution	2.4 V ≤ AV <sub>REFP</sub> ≤ AV <sub>DD</sub> ≤ 3.6 V		±6.0	LSB
		10-bit resolution	1.8 V ≤ AV <sub>REFP</sub> ≤ AV <sub>DD</sub> ≤ 3.6 V		±5.0	
		8-bit resolution	1.6 V ≤ AV <sub>REFP</sub> ≤ AV <sub>DD</sub> ≤ 3.6 V		±2.5	
Conversion time	t <sub>CONV</sub>	ADTYP = 0, 12-bit resolution	2.4 V ≤ AV <sub>REFP</sub> ≤ AV <sub>DD</sub> ≤ 3.6 V	3.375		μs
		ADTYP = 0, 10-bit resolution <sup>Note 1</sup>	1.8 V ≤ AV <sub>REFP</sub> ≤ AV <sub>DD</sub> ≤ 3.6 V	6.75		
		ADTYP = 0, 8-bit resolution <sup>Note 2</sup>	1.6 V ≤ AV <sub>REFP</sub> ≤ AV <sub>DD</sub> ≤ 3.6 V	13.5		
		ADTYP = 1, 8-bit resolution	2.4 V ≤ AV <sub>REFP</sub> ≤ AV <sub>DD</sub> ≤ 3.6 V	2.5625		
			1.8 V ≤ AV <sub>REFP</sub> ≤ AV <sub>DD</sub> ≤ 3.6 V	5.125		
			1.6 V ≤ AV <sub>REFP</sub> ≤ AV <sub>DD</sub> ≤ 3.6 V	10.25		
Zero-scale error <sup>Note 3</sup>	E <sub>ZS</sub>	12-bit resolution	2.4 V ≤ AV <sub>REFP</sub> ≤ AV <sub>DD</sub> ≤ 3.6 V		±4.5	LSB
		10-bit resolution	1.8 V ≤ AV <sub>REFP</sub> ≤ AV <sub>DD</sub> ≤ 3.6 V		±4.5	
		8-bit resolution	1.6 V ≤ AV <sub>REFP</sub> ≤ AV <sub>DD</sub> ≤ 3.6 V		±2.0	
Full-scale error <sup>Note 3</sup>	E <sub>FS</sub>	12-bit resolution	2.4 V ≤ AV <sub>REFP</sub> ≤ AV <sub>DD</sub> ≤ 3.6 V		±4.5	LSB
		10-bit resolution	1.8 V ≤ AV <sub>REFP</sub> ≤ AV <sub>DD</sub> ≤ 3.6 V		±4.5	
		8-bit resolution	1.6 V ≤ AV <sub>REFP</sub> ≤ AV <sub>DD</sub> ≤ 3.6 V		±2.0	
Integral linearity error <sup>Note 3</sup>	ILE	12-bit resolution	2.4 V ≤ AV <sub>REFP</sub> ≤ AV <sub>DD</sub> ≤ 3.6 V		±2.0	LSB
		10-bit resolution	1.8 V ≤ AV <sub>REFP</sub> ≤ AV <sub>DD</sub> ≤ 3.6 V		±1.5	
		8-bit resolution	1.6 V ≤ AV <sub>REFP</sub> ≤ AV <sub>DD</sub> ≤ 3.6 V		±1.0	
Differential linearity error <sup>Note 3</sup>	DLE	12-bit resolution	2.4 V ≤ AV <sub>REFP</sub> ≤ AV <sub>DD</sub> ≤ 3.6 V		±1.5	LSB
		10-bit resolution	1.8 V ≤ AV <sub>REFP</sub> ≤ AV <sub>DD</sub> ≤ 3.6 V		±1.5	
		8-bit resolution	1.6 V ≤ AV <sub>REFP</sub> ≤ AV <sub>DD</sub> ≤ 3.6 V		±1.0	
Analog input voltage	V <sub>AIN</sub>		0		AV <sub>REFP</sub>	V

- Notes 1.** Cannot be used for lower 2 bit of ADCR register  
**2.** Cannot be used for lower 4 bit of ADCR register  
**3.** Excludes quantization error (±1/2 LSB).

<R> (3) When reference voltage (+) = AV<sub>DD</sub> (ADREFP1 = 0, ADREFP0 = 0), reference voltage (-) = AV<sub>SS</sub> (ADREFM = 0), target for conversion: ANI0 to ANI12

(T<sub>A</sub> = -40 to +85°C, 1.6 V ≤ AV<sub>DD</sub> ≤ V<sub>DD</sub> ≤ 3.6 V, V<sub>SS</sub> = 0 V, AV<sub>SS</sub> = 0 V, Reference voltage (+) = AV<sub>DD</sub>, Reference voltage (-) = AV<sub>SS</sub> = 0 V)

Parameter	Symbol	Conditions	MIN.	TYP.	MAX.	Unit
Resolution	R <sub>ES</sub>	2.4 V ≤ AV <sub>DD</sub> ≤ 3.6 V	8		12	bit
		1.8 V ≤ AV <sub>DD</sub> ≤ 3.6 V	8		10 <sup>Note 1</sup>	
		1.6 V ≤ AV <sub>DD</sub> ≤ 3.6 V	8 <sup>Note 2</sup>			
Overall error <sup>Note 3</sup>	AINL	12-bit resolution	2.4 V ≤ AV <sub>DD</sub> ≤ 3.6 V		±7.5	LSB
		10-bit resolution	1.8 V ≤ AV <sub>DD</sub> ≤ 3.6 V		±5.5	
		8-bit resolution	1.6 V ≤ AV <sub>DD</sub> ≤ 3.6 V		±3.0	
Conversion time	t <sub>CONV</sub>	ADTYP = 0, 12-bit resolution	2.4 V ≤ AV <sub>DD</sub> ≤ 3.6 V	3.375		μs
		ADTYP = 0, 10-bit resolution <sup>Note 1</sup>	1.8 V ≤ AV <sub>DD</sub> ≤ 3.6 V	6.75		
		ADTYP = 0, 8-bit resolution <sup>Note 2</sup>	1.6 V ≤ AV <sub>DD</sub> ≤ 3.6 V	13.5		
		ADTYP = 1, 8-bit resolution	2.4 V ≤ AV <sub>DD</sub> ≤ 3.6 V	2.5625		
			1.8 V ≤ AV <sub>DD</sub> ≤ 3.6 V	5.125		
1.6 V ≤ AV <sub>DD</sub> ≤ 3.6 V	10.25					
Zero-scale error <sup>Note 3</sup>	E <sub>ZS</sub>	12-bit resolution	2.4 V ≤ AV <sub>DD</sub> ≤ 3.6 V		±6.0	LSB
		10-bit resolution	1.8 V ≤ AV <sub>DD</sub> ≤ 3.6 V		±5.0	
		8-bit resolution	1.6 V ≤ AV <sub>DD</sub> ≤ 3.6 V		±2.5	
Full-scale error <sup>Note 3</sup>	E <sub>FS</sub>	12-bit resolution	2.4 V ≤ AV <sub>DD</sub> ≤ 3.6 V		±6.0	LSB
		10-bit resolution	1.8 V ≤ AV <sub>DD</sub> ≤ 3.6 V		±5.0	
		8-bit resolution	1.6 V ≤ AV <sub>DD</sub> ≤ 3.6 V		±2.5	
Integral linearity error <sup>Note 3</sup>	ILE	12-bit resolution	2.4 V ≤ AV <sub>DD</sub> ≤ 3.6 V		±3.0	LSB
		10-bit resolution	1.8 V ≤ AV <sub>DD</sub> ≤ 3.6 V		±2.0	
		8-bit resolution	1.6 V ≤ AV <sub>DD</sub> ≤ 3.6 V		±1.5	
Differential linearity error <sup>Note 3</sup>	DLE	12-bit resolution	2.4 V ≤ AV <sub>DD</sub> ≤ 3.6 V		±2.0	LSB
		10-bit resolution	1.8 V ≤ AV <sub>DD</sub> ≤ 3.6 V		±2.0	
		8-bit resolution	1.6 V ≤ AV <sub>DD</sub> ≤ 3.6 V		±1.5	
<R> Analog input voltage	V <sub>AIN</sub>		0		AV <sub>DD</sub>	V

**Notes 1.** Cannot be used for lower 2 bit of ADCR register

**2.** Cannot be used for lower 4 bit of ADCR register

**3.** Excludes quantization error (±1/2 LSB).

<R> (4) When reference voltage (+) = AV<sub>REFP</sub>/ANI0 (ADREFP1 = 0, ADREFP0 = 1), reference voltage (-) = AV<sub>REFM</sub>/ANI1 (ADREFM = 1), target for conversion: ANI16 to ANI30, internal reference voltage, temperature sensor output voltage

(T<sub>A</sub> = -40 to +85°C, 1.6 V ≤ EV<sub>DD0</sub> ≤ V<sub>DD</sub> ≤ 3.6 V, 1.6 V ≤ AV<sub>REFP</sub> ≤ AV<sub>DD</sub> ≤ V<sub>DD</sub> ≤ 3.6 V, V<sub>SS</sub> = EV<sub>SS0</sub> = 0 V, AV<sub>SS</sub> = 0 V, Reference voltage (+) = AV<sub>REFP</sub>, Reference voltage (-) = AV<sub>REFM</sub> = 0 V)

Parameter	Symbol	Conditions	MIN.	TYP.	MAX.	Unit
Resolution	RES	2.4 V ≤ AV <sub>REFP</sub> ≤ AV <sub>DD</sub> ≤ 3.6 V	8		12	bit
		1.8 V ≤ AV <sub>REFP</sub> ≤ AV <sub>DD</sub> ≤ 3.6 V	8		10 <sup>Note 1</sup>	
		1.6 V ≤ AV <sub>REFP</sub> ≤ AV <sub>DD</sub> ≤ 3.6 V	g <sup>Note 2</sup>			
Overall error <sup>Note 3</sup>	AINL	12-bit resolution	2.4 V ≤ AV <sub>REFP</sub> ≤ AV <sub>DD</sub> ≤ 3.6 V		±7.0	LSB
		10-bit resolution	1.8 V ≤ AV <sub>REFP</sub> ≤ AV <sub>DD</sub> ≤ 3.6 V		±5.5	
		8-bit resolution	1.6 V ≤ AV <sub>REFP</sub> ≤ AV <sub>DD</sub> ≤ 3.6 V		±3.0	
Conversion time	t <sub>CONV</sub>	ADTYP = 0, 12-bit resolution	2.4 V ≤ AV <sub>REFP</sub> ≤ AV <sub>DD</sub> ≤ 3.6 V	4.125		μs
		ADTYP = 0, 10-bit resolution <sup>Note 1</sup>	1.8 V ≤ AV <sub>REFP</sub> ≤ AV <sub>DD</sub> ≤ 3.6 V	9.5		
		ADTYP = 0, 8-bit resolution <sup>Note 2</sup>	1.6 V ≤ AV <sub>REFP</sub> ≤ AV <sub>DD</sub> ≤ 3.6 V	57.5		
		ADTYP = 1, 8-bit resolution	2.4 V ≤ AV <sub>REFP</sub> ≤ AV <sub>DD</sub> ≤ 3.6 V	3.3125		
			1.8 V ≤ AV <sub>REFP</sub> ≤ AV <sub>DD</sub> ≤ 3.6 V	7.875		
			1.6 V ≤ AV <sub>REFP</sub> ≤ AV <sub>DD</sub> ≤ 3.6 V	54.25		
Zero-scale error <sup>Note 3</sup>	E <sub>ZS</sub>	12-bit resolution	2.4 V ≤ AV <sub>REFP</sub> ≤ AV <sub>DD</sub> ≤ 3.6 V		±5.0	LSB
		10-bit resolution	1.8 V ≤ AV <sub>REFP</sub> ≤ AV <sub>DD</sub> ≤ 3.6 V		±5.0	
		8-bit resolution	1.6 V ≤ AV <sub>REFP</sub> ≤ AV <sub>DD</sub> ≤ 3.6 V		±2.5	
Full-scale error <sup>Note 3</sup>	E <sub>FS</sub>	12-bit resolution	2.4 V ≤ AV <sub>REFP</sub> ≤ AV <sub>DD</sub> ≤ 3.6 V		±5.0	LSB
		10-bit resolution	1.8 V ≤ AV <sub>REFP</sub> ≤ AV <sub>DD</sub> ≤ 3.6 V		±5.0	
		8-bit resolution	1.6 V ≤ AV <sub>REFP</sub> ≤ AV <sub>DD</sub> ≤ 3.6 V		±2.5	
Integral linearity error <sup>Note 3</sup>	ILE	12-bit resolution	2.4 V ≤ AV <sub>REFP</sub> ≤ AV <sub>DD</sub> ≤ 3.6 V		±3.0	LSB
		10-bit resolution	1.8 V ≤ AV <sub>REFP</sub> ≤ AV <sub>DD</sub> ≤ 3.6 V		±2.0	
		8-bit resolution	1.6 V ≤ AV <sub>REFP</sub> ≤ AV <sub>DD</sub> ≤ 3.6 V		±1.5	
Differential linearity error <sup>Note 3</sup>	DLE	12-bit resolution	2.4 V ≤ AV <sub>REFP</sub> ≤ AV <sub>DD</sub> ≤ 3.6 V		±2.0	LSB
		10-bit resolution	1.8 V ≤ AV <sub>REFP</sub> ≤ AV <sub>DD</sub> ≤ 3.6 V		±2.0	
		8-bit resolution	1.6 V ≤ AV <sub>REFP</sub> ≤ AV <sub>DD</sub> ≤ 3.6 V		±1.5	
Analog input voltage	V <sub>AIN</sub>		0		AV <sub>REFP</sub> and EV <sub>DD0</sub>	V
		Internal reference voltage (2.4 V ≤ V <sub>DD</sub> ≤ 3.6 V, HS (high-speed main) mode)	V <sub>BGR</sub> <sup>Note 4</sup>			V
		Temperature sensor output voltage (2.4 V ≤ V <sub>DD</sub> ≤ 3.6 V, HS (high-speed main) mode)	V <sub>TMPS25</sub> <sup>Note 4</sup>			V

- Notes 1.** Cannot be used for lower 2 bit of ADCR register  
**2.** Cannot be used for lower 4 bit of ADCR register  
**3.** Excludes quantization error (±1/2 LSB).  
**4.** See 2.6.2 Temperature sensor, internal reference voltage output characteristics.

<R> (5) When reference voltage (+) = AV<sub>DD</sub> (ADREFP1 = 0, ADREFP0 = 0), reference voltage (-) = AV<sub>SS</sub> (ADREFM = 0), target for conversion: ANI16 to ANI30, internal reference voltage, temperature sensor output voltage

(T<sub>A</sub> = -40 to +85°C, 1.6 V ≤ EV<sub>DD0</sub> ≤ V<sub>DD0</sub> ≤ 3.6 V, 1.6 V ≤ AV<sub>DD</sub> ≤ V<sub>DD</sub> ≤ 3.6 V, V<sub>SS</sub> = EV<sub>SS0</sub> = 0 V, AV<sub>SS</sub> = 0 V, Reference voltage (+) = AV<sub>DD</sub>, Reference voltage (-) = AV<sub>SS</sub> = 0 V)

Parameter	Symbol	Conditions	MIN.	TYP.	MAX.	Unit	
Resolution	RES	2.4 V ≤ AV <sub>DD</sub> ≤ 3.6 V	8		12	bit	
		1.8 V ≤ AV <sub>DD</sub> ≤ 3.6 V	8		10 <sup>Note 1</sup>		
		1.6 V ≤ AV <sub>DD</sub> ≤ 3.6 V	8 <sup>Note 2</sup>				
Overall error <sup>Note 3</sup>	AINL	12-bit resolution	2.4 V ≤ AV <sub>DD</sub> ≤ 3.6 V		±8.5	LSB	
		10-bit resolution	1.8 V ≤ AV <sub>DD</sub> ≤ 3.6 V		±6.0		
		8-bit resolution	1.6 V ≤ AV <sub>DD</sub> ≤ 3.6 V		±3.5		
Conversion time	t <sub>CONV</sub>	ADTYP = 0, 12-bit resolution	2.4 V ≤ AV <sub>DD</sub> ≤ 3.6 V	4.125		μs	
			1.8 V ≤ AV <sub>DD</sub> ≤ 3.6 V	9.5			
			1.6 V ≤ AV <sub>DD</sub> ≤ 3.6 V	57.5			
		ADTYP = 1, 8-bit resolution	2.4 V ≤ AV <sub>DD</sub> ≤ 3.6 V	3.3125		μs	
			1.8 V ≤ AV <sub>DD</sub> ≤ 3.6 V	7.875			
			1.6 V ≤ AV <sub>DD</sub> ≤ 3.6 V	54.25			
Zero-scale error <sup>Note 3</sup>	E <sub>ZS</sub>	12-bit resolution	2.4 V ≤ AV <sub>DD</sub> ≤ 3.6 V		±8.0	LSB	
		10-bit resolution	1.8 V ≤ AV <sub>DD</sub> ≤ 3.6 V		±5.5		
		8-bit resolution	1.6 V ≤ AV <sub>DD</sub> ≤ 3.6 V		±3.0		
Full-scale error <sup>Note 3</sup>	E <sub>FS</sub>	12-bit resolution	2.4 V ≤ AV <sub>DD</sub> ≤ 3.6 V		±8.0	LSB	
		10-bit resolution	1.8 V ≤ AV <sub>DD</sub> ≤ 3.6 V		±5.5		
		8-bit resolution	1.6 V ≤ AV <sub>DD</sub> ≤ 3.6 V		±3.0		
Integral linearity error <sup>Note 3</sup>	ILE	12-bit resolution	2.4 V ≤ AV <sub>DD</sub> ≤ 3.6 V		±3.5	LSB	
		10-bit resolution	1.8 V ≤ AV <sub>DD</sub> ≤ 3.6 V		±2.5		
		8-bit resolution	1.6 V ≤ AV <sub>DD</sub> ≤ 3.6 V		±1.5		
Differential linearity error <sup>Note 3</sup>	DLE	12-bit resolution	2.4 V ≤ AV <sub>DD</sub> ≤ 3.6 V		±2.5	LSB	
		10-bit resolution	1.8 V ≤ AV <sub>DD</sub> ≤ 3.6 V		±2.5		
		8-bit resolution	1.6 V ≤ AV <sub>DD</sub> ≤ 3.6 V		±2.0		
Analog input voltage	V <sub>AIN</sub>		0		AV <sub>DD</sub> and EV <sub>DD0</sub>	V	
		Interanal reference voltage (2.4 V ≤ V <sub>DD</sub> ≤ 3.6 V, HS (high-speed main) mode)	V <sub>BGR</sub> <sup>Note 4</sup>				V
		Temperature sensor output voltage (2.4 V ≤ V <sub>DD</sub> ≤ 3.6 V, HS (high-speed main) mode)	V <sub>TMPS25</sub> <sup>Note 4</sup>				V

- Notes 1.** Cannot be used for lower 2 bit of ADCR register  
**2.** Cannot be used for lower 4 bit of ADCR register  
**3.** Excludes quantization error (±1/2 LSB).  
**4.** See 2.6.2 Temperature sensor, internal reference voltage output characteristics.

<R> (6) When reference voltage (+) = Internal reference voltage (1.45 V) (ADREFP1 = 1, ADREFP0 = 0), reference voltage (-) = AV<sub>SS</sub> (ADREFM = 0), target ANI pin: ANI0 to ANI12, ANI16 to ANI30

(T<sub>A</sub> = -40 to +85°C, 2.4 V ≤ V<sub>DD</sub> ≤ 3.6 V, 1.6 V ≤ EV<sub>DD</sub> ≤ V<sub>DD</sub>, 1.6 V ≤ AV<sub>DD</sub> ≤ V<sub>DD</sub>, V<sub>SS</sub> = EV<sub>SS0</sub> = 0 V, AV<sub>SS</sub> = 0 V, Reference voltage (+) = Internal reference voltage, Reference voltage (-) = AV<sub>SS</sub> = 0 V, HS (high-speed main mode)

Parameter	Symbol	Conditions	MIN.	TYP.	MAX.	Unit
Resolution	R <sub>ES</sub>		8			bit
Conversion time	t <sub>CONV</sub>	8-bit resolution	16			μs
Zero-scale error <sup>Note</sup>	E <sub>ZS</sub>	8-bit resolution			±4.0	LSB
Integral linearity error <sup>Note</sup>	ILE	8-bit resolution			±2.0	LSB
Differential linearity error <sup>Note</sup>	DLE	8-bit resolution			±2.5	LSB
Reference voltage (+)	AV <sub>REF(+)</sub>	= Internal reference voltage (V <sub>BGR</sub> )	1.38	1.45	1.5	V
Analog input voltage	V <sub>AIN</sub>		0		V <sub>BGR</sub>	V

**Note** Excludes quantization error (±1/2 LSB).

### 2.6.2 Temperature sensor, internal reference voltage output characteristics

(T<sub>A</sub> = -40 to +85°C, 2.4 V ≤ V<sub>DD</sub> ≤ 3.6 V, V<sub>SS</sub> = 0 V, HS (high-speed main) mode)

Parameter	Symbol	Conditions	MIN.	TYP.	MAX.	Unit
Temperature sensor output voltage	V <sub>TMP525</sub>	Setting ADS register = 80H, T <sub>A</sub> = +25°C		1.05		V
Internal reference voltage	V <sub>BGR</sub>	Setting ADS register = 81H	1.38	1.45	1.5	V
Temperature coefficient	F <sub>VTMP5</sub>	Temperature sensor output voltage that depends on the temperature		-3.6		mV/°C
Operation stabilization wait time	t <sub>AMP</sub>		10			μs

### 2.6.3 POR circuit characteristics

(T<sub>A</sub> = -40 to +85°C, V<sub>SS</sub> = 0 V)

Parameter	Symbol	Conditions	MIN.	TYP.	MAX.	Unit
Detection voltage	V <sub>POR</sub>	Power supply rise time	1.47	1.51	1.55	V
	V <sub>PDR</sub>	Power supply fall time	1.46	1.50	1.54	V
Minimum pulse width <sup>Note</sup>	T <sub>PW</sub>		300			μs

**Note** This is the time required for the POR circuit to execute a reset when V<sub>DD</sub> falls below V<sub>PDR</sub>. When the microcontroller enters STOP mode or if the main system clock (f<sub>MAIN</sub>) has been stopped by setting bit 0 (HIOSTOP) and bit 7 (MSTOP) of the clock operation status control register (CSC), this is the time required for the POR circuit to execute a reset before V<sub>DD</sub> rises to V<sub>POR</sub> after having fallen below 0.7 V.

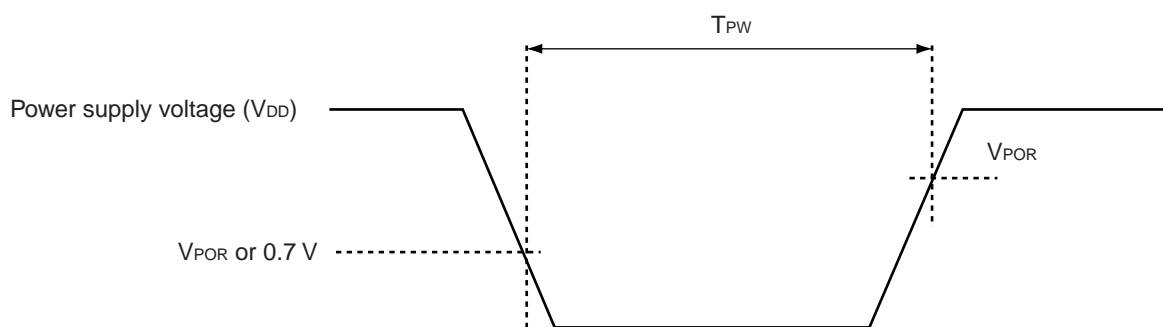

## 2.6.4 LVD circuit characteristics

**LVD Detection Voltage of Reset Mode and Interrupt Mode**(T<sub>A</sub> = -40 to +85°C, V<sub>PDR</sub> ≤ V<sub>DD</sub> ≤ 3.6 V, V<sub>SS</sub> = 0 V)

Parameter		Symbol	Conditions	MIN.	TYP.	MAX.	Unit
Detection voltage	Supply voltage level	V <sub>LVD2</sub>	Power supply rise time	3.07	3.13	3.19	V
			Power supply fall time	3.00	3.06	3.12	V
		V <sub>LVD3</sub>	Power supply rise time	2.96	3.02	3.08	V
			Power supply fall time	2.90	2.96	3.02	V
		V <sub>LVD4</sub>	Power supply rise time	2.86	2.92	2.97	V
			Power supply fall time	2.80	2.86	2.91	V
		V <sub>LVD5</sub>	Power supply rise time	2.76	2.81	2.87	V
			Power supply fall time	2.70	2.75	2.81	V
		V <sub>LVD6</sub>	Power supply rise time	2.66	2.71	2.76	V
			Power supply fall time	2.60	2.65	2.70	V
		V <sub>LVD7</sub>	Power supply rise time	2.56	2.61	2.66	V
			Power supply fall time	2.50	2.55	2.60	V
		V <sub>LVD8</sub>	Power supply rise time	2.45	2.50	2.55	V
			Power supply fall time	2.40	2.45	2.50	V
		V <sub>LVD9</sub>	Power supply rise time	2.05	2.09	2.13	V
			Power supply fall time	2.00	2.04	2.08	V
		V <sub>LVD10</sub>	Power supply rise time	1.94	1.98	2.02	V
			Power supply fall time	1.90	1.94	1.98	V
		V <sub>LVD11</sub>	Power supply rise time	1.84	1.88	1.91	V
			Power supply fall time	1.80	1.84	1.87	V
		V <sub>LVD12</sub>	Power supply rise time	1.74	1.77	1.81	V
			Power supply fall time	1.70	1.73	1.77	V
		V <sub>LVD13</sub>	Power supply rise time	1.64	1.67	1.70	V
			Power supply fall time	1.60	1.63	1.66	V
Minimum pulse width	t <sub>LW</sub>		300			μs	
Detection delay time					300	μs	

**Caution** Set the detection voltage (V<sub>LVD</sub>) to be within the operating voltage range. The operating voltage range depends on the setting of the user option byte (000C2H/010C2H). The following shows the operating voltage range.

**HS (high-speed main) mode:** V<sub>DD</sub> = 2.7 to 3.6 V@1 MHz to 32 MHz

V<sub>DD</sub> = 2.4 to 3.6 V@1 MHz to 16 MHz

**LS (low-speed main) mode:** V<sub>DD</sub> = 1.8 to 3.6 V@1 MHz to 8 MHz

**LV (low-voltage main) mode:** V<sub>DD</sub> = 1.6 to 3.6 V@1 MHz to 4 MHz

**LVD Detection Voltage of Interrupt & Reset Mode**(T<sub>A</sub> = -40 to +85°C, V<sub>PDR</sub> ≤ V<sub>DD</sub> ≤ 3.6 V, V<sub>SS</sub> = 0 V)

Parameter	Symbol	Conditions	MIN.	TYP.	MAX.	Unit	
Interrupt & reset mode	V <sub>LVD13</sub>	VPOC2, VPOC1, VPOC0 = 0, 0, 0, falling reset voltage	1.60	1.63	1.66	V	
	V <sub>LVD12</sub>	LVIS1, LVIS0 = 1, 0	Rising release reset voltage	1.74	1.77	1.81	V
			Falling interrupt voltage	1.70	1.73	1.77	V
	V <sub>LVD11</sub>	LVIS1, LVIS0 = 0, 1	Rising release reset voltage	1.84	1.88	1.91	V
			Falling interrupt voltage	1.80	1.84	1.87	V
	V <sub>LVD4</sub>	LVIS1, LVIS0 = 0, 0	Rising release reset voltage	2.86	2.92	2.97	V
			Falling interrupt voltage	2.80	2.86	2.91	V
	V <sub>LVD11</sub>	VPOC2, VPOC1, VPOC0 = 0, 0, 1, falling reset voltage	1.80	1.84	1.87	V	
	V <sub>LVD10</sub>	LVIS1, LVIS0 = 1, 0	Rising release reset voltage	1.94	1.98	2.02	V
			Falling interrupt voltage	1.90	1.94	1.98	V
	V <sub>LVD9</sub>	LVIS1, LVIS0 = 0, 1	Rising release reset voltage	2.05	2.09	2.13	V
			Falling interrupt voltage	2.00	2.04	2.08	V
	V <sub>LVD2</sub>	LVIS1, LVIS0 = 0, 0	Rising release reset voltage	3.07	3.13	3.19	V
			Falling interrupt voltage	3.00	3.06	3.12	V
	V <sub>LVD8</sub>	VPOC2, VPOC1, VPOC0 = 0, 1, 0, falling reset voltage	2.40	2.45	2.50	V	
	V <sub>LVD7</sub>	LVIS1, LVIS0 = 1, 0	Rising release reset voltage	2.56	2.61	2.66	V
			Falling interrupt voltage	2.50	2.55	2.60	V
	V <sub>LVD6</sub>	LVIS1, LVIS0 = 0, 1	Rising release reset voltage	2.66	2.71	2.76	V
			Falling interrupt voltage	2.60	2.65	2.70	V
	V <sub>LVD5</sub>	VPOC2, VPOC1, VPOC0 = 0, 1, 1, falling reset voltage	2.70	2.75	2.81	V	
V <sub>LVD4</sub>	LVIS1, LVIS0 = 1, 0	Rising release reset voltage	2.86	2.92	2.97	V	
		Falling interrupt voltage	2.80	2.86	2.91	V	
V <sub>LVD3</sub>	LVIS1, LVIS0 = 0, 1	Rising release reset voltage	2.96	3.02	3.08	V	
		Falling interrupt voltage	2.90	2.96	3.02	V	

**Caution** Set the detection voltage (V<sub>LVD</sub>) to be within the operating voltage range. The operating voltage range depends on the setting of the user option byte (000C2H/010C2H). The following shows the operating voltage range.

**HS (high-speed main) mode:** V<sub>DD</sub> = 2.7 to 3.6 V@1 MHz to 32 MHz

V<sub>DD</sub> = 2.4 to 3.6 V@1 MHz to 16 MHz

**LS (low-speed main) mode:** V<sub>DD</sub> = 1.8 to 3.6 V@1 MHz to 8 MHz

**LV (low-voltage main) mode:** V<sub>DD</sub> = 1.6 to 3.6 V@1 MHz to 4 MHz

## 2.6.5 Supply voltage rise slope characteristics

(T<sub>A</sub> = -40 to +85°C, V<sub>SS</sub> = 0 V)

Parameter	Symbol	Conditions	MIN.	TYP.	MAX.	Unit
Supply voltage rise	SV <sub>DD</sub>				54	V/ms

**Caution** Be sure to maintain the internal reset state until V<sub>DD</sub> reaches the operating voltage range specified in 2.4 AC Characteristics, by using the LVD circuit or external reset pin.

<R> 2.7 RAM Data Retention Characteristics

<R> (T<sub>A</sub> = -40 to +85°C, V<sub>SS</sub> = 0 V)

Parameter	Symbol	Conditions	MIN.	TYP.	MAX.	Unit
Data retention supply voltage	V <sub>DDDR</sub>		1.46 <sup>Note</sup>		3.6	V

<R> **Note** This depends on the POR detection voltage. For a falling voltage, data in RAM are retained until the voltage reaches the level that triggers a POR reset but not once it reaches the level at which a POR reset is generated.

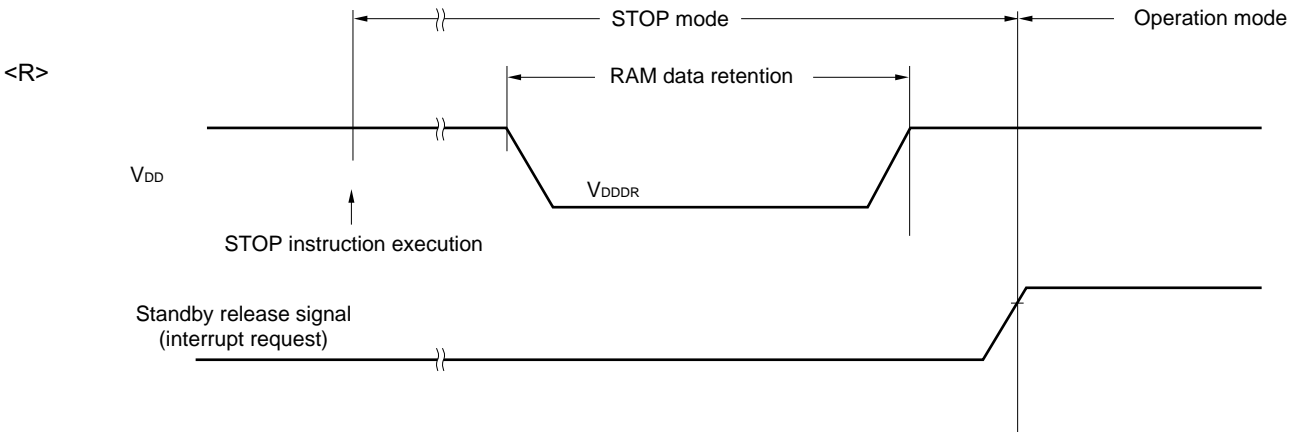

<R> 2.8 Flash Memory Programming Characteristics

(T<sub>A</sub> = -40 to +85°C, 1.8 V ≤ V<sub>DD</sub> ≤ 3.6 V, V<sub>SS</sub> = 0 V)

Parameter	Symbol	Conditions	MIN.	TYP.	MAX.	Unit
CPU/peripheral hardware clock frequency	f <sub>CLK</sub>	1.8 V ≤ V <sub>DD</sub> ≤ 3.6 V	1		32	MHz
Number of code flash rewrites <sup>Notes 1, 2</sup>	C <sub>erwr</sub>	Retained for 20 years T <sub>A</sub> = 85°C <sup>Note 3</sup>	1,000			Times
Number of data flash rewrites <sup>Notes 1, 2</sup>		Retained for 1 years T <sub>A</sub> = 25°C <sup>Note 3</sup>		1,000,000		
		Retained for 5 years T <sub>A</sub> = 85°C <sup>Note 3</sup>	100,000			
		Retained for 20 years T <sub>A</sub> = 85°C <sup>Note 3</sup>	10,000			

- Notes 1.** 1 erase + 1 write after the erase is regarded as 1 rewrite.  
The retaining years are until next rewrite after the rewrite.
- 2.** When using flash memory programmer and Renesas Electronics self programming library
- 3.** These are the characteristics of the flash memory and the results obtained from reliability testing by Renesas Electronics Corporation.



### 2.9 Dedicated Flash Memory Programmer Communication (UART)

(T<sub>A</sub> = -40 to +85°C, 1.8 V ≤ EV<sub>DD0</sub> ≤ V<sub>DD</sub> ≤ 3.6 V, V<sub>SS</sub> = EV<sub>SS0</sub> = 0 V)

Parameter	Symbol	Conditions	MIN.	TYP.	MAX.	Unit
Transfer rate		During flash memory programming	115.2 k		1 M	bps

### 2.10 Timing Specs for Switching Flash Memory Programming Modes

(T<sub>A</sub> = -40 to +85°C, 1.8 V ≤ EV<sub>DD0</sub> ≤ V<sub>DD</sub> ≤ 3.6 V, V<sub>SS</sub> = EV<sub>SS0</sub> = 0 V)

Parameter	Symbol	Conditions	MIN.	TYP.	MAX.	Unit
How long from when an external reset ends until the initial communication settings are specified	t <sub>SUINIT</sub>	POR and LVD reset must end before the external reset ends.			100	ms
How long from when the TOOL0 pin is placed at the low level until a external reset ends	t <sub>SU</sub>	POR and LVD reset must end before the external reset ends.	10			μs
<R> How long the TOOL0 pin must be kept at the low level after an external reset ends (except flash firmware processing time)	t <sub>HD</sub>	POR and LVD reset must end before the external reset ends.	1			ms

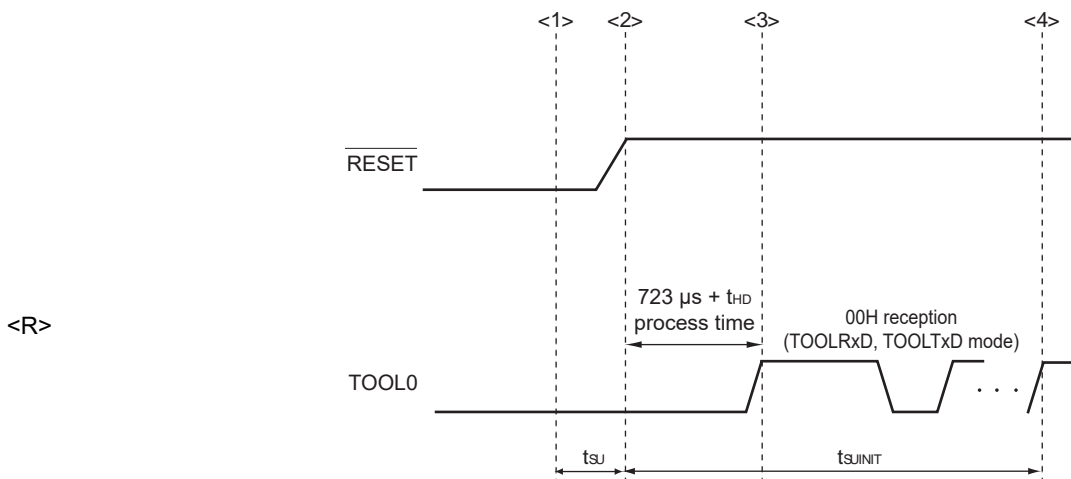

- <1> The low level is input to the TOOL0 pin.
- <2> The pins reset ends (POR and LVD reset must end before the external reset ends.).
- <3> The TOOL0 pin is set to the high level.
- <4> Setting of the flash memory programming mode by UART reception and complete the baud rate setting.

**Remark** t<sub>SUINIT</sub>: The segment shows that it is necessary to finish specifying the initial communication settings within 100 ms from when the resets end.

t<sub>SU</sub>: How long from when the TOOL0 pin is placed at the low level until a external reset ends

<R> t<sub>HD</sub>: How long to keep the TOOL0 pin at the low level from when the external resets end (except flash firmware processing time)

### 3. ELECTRICAL SPECIFICATIONS (G: INDUSTRIAL APPLICATIONS $T_A = -40$ to $+105^\circ\text{C}$ )

This chapter describes the following electrical specifications.

Target products G: Industrial applications  $T_A = -40$  to  $+105^\circ\text{C}$   
R5F10EBAGNA, R5F10EBCGNA, R5F10EBDGNA, R5F10EBEGNA  
R5F10EGAGFB, R5F10EGCGFB, R5F10EGDGFB, R5F10EGEGFB  
R5F10EGAGNA, R5F10EGCGNA, R5F10EGDGNA, R5F10EGEGNA  
R5F10ELCGFB, R5F10ELDGFB, R5F10ELEGFB

- Cautions**
1. The RL78/G1A has an on-chip debug function, which is provided for development and evaluation. Do not use the on-chip debug function in products designated for mass production, because the guaranteed number of rewritable times of the flash memory may be exceeded when this function is used, and product reliability therefore cannot be guaranteed. Renesas Electronics is not liable for problems occurring when the on-chip debug function is used.
  2. With products not provided with an  $EV_{DD0}$  or  $EV_{SS0}$  pin, replace  $EV_{DD0}$  with  $V_{DD}$ , or replace  $EV_{SS0}$  with  $V_{SS}$ .
  3. Please contact Renesas Electronics sales office for derating of operation under  $T_A = +85^\circ\text{C}$  to  $+105^\circ\text{C}$ . Derating is the systematic reduction of load for the sake of improved reliability.

**Remark** When RL78/G1A is used in the range of  $T_A = -40$  to  $+85^\circ\text{C}$ , see 2. **ELECTRICAL SPECIFICATIONS** ( $T_A = -40$  to  $+85^\circ\text{C}$ ).

## 3.1 Absolute Maximum Ratings

Absolute Maximum Ratings ( $T_A = 25^\circ\text{C}$ ) (1/2)

Parameter	Symbols	Conditions	Ratings	Unit
Supply voltage	$V_{DD}$		-0.5 to +6.5	V
	$EV_{DD0}$		-0.5 to +6.5	V
	$AV_{DD}$		-0.5 to +4.6	V
	$AV_{REFP}$		-0.3 to $AV_{DD} + 0.3$ <sup>Note 3</sup>	V
	$EV_{SS0}$		-0.5 to +0.3	V
	$AV_{SS}$		-0.5 to +0.3	V
	$AV_{REFM}$		-0.3 to $AV_{DD} + 0.3$ <sup>Note 3</sup> and $AV_{REFM} \leq AV_{REFP}$	V
REGC pin input voltage	$V_{IREGC}$	REGC	-0.3 to +2.8 and -0.3 to $V_{DD} + 0.3$ <sup>Note 1</sup>	V
Input voltage	$V_{I1}$	P00 to P06, P10 to P16, P30, P31, P40 to P43, P50, P51, P70 to P77, P120, P140, P141	-0.3 to $EV_{DD0} + 0.3$ and -0.3 to $V_{DD} + 0.3$ <sup>Note 2</sup>	V
	$V_{I2}$	P60 to P63 (N-ch open-drain)	-0.3 to +6.5	V
	$V_{I3}$	P121 to P124, P137, EXCLK, EXCLKS, $\overline{\text{RESET}}$	-0.3 to $V_{DD} + 0.3$ <sup>Note 2</sup>	V
	$V_{I4}$	P20 to P27, P150 to P154	-0.3 to $AV_{DD} + 0.3$ <sup>Note 2</sup>	V
Output voltage	$V_{O1}$	P00 to P06, P10 to P16, P30, P31, P40 to P43, P50, P51, P60 to P63, P70 to P77, P120, P130, P140, P141	-0.3 to $EV_{DD0} + 0.3$ <sup>Note 2</sup>	V
	$V_{O2}$	P20 to P27, P150 to P154	-0.3 to $AV_{DD} + 0.3$ <sup>Note 2</sup>	V
Analog input voltage	$V_{AI1}$	ANI16 to ANI30	-0.3 to $EV_{DD0} + 0.3$ and -0.3 to $AV_{REF(+)} + 0.3$ <sup>Notes 2, 4</sup>	V
	$V_{AI2}$	ANI0 to ANI12	-0.3 to $AV_{DD} + 0.3$ and -0.3 to $AV_{REF(+)} + 0.3$ <sup>Notes 2, 4</sup>	V

**Notes 1.** Connect the REGC pin to  $V_{SS}$  via a capacitor (0.47 to 1  $\mu\text{F}$ ). This value regulates the absolute maximum rating of the REGC pin. Do not use this pin with voltage applied to it.

**2.** Must be 6.5 V or lower.

**3.** Must be 4.6 V or lower.

**4.** Do not exceed  $AV_{REF(+)} + 0.3$  V in case of A/D conversion target pin.

**Caution** Product quality may suffer if the absolute maximum rating is exceeded even momentarily for any parameter. That is, the absolute maximum ratings are rated values at which the product is on the verge of suffering physical damage, and therefore the product must be used under conditions that ensure that the absolute maximum ratings are not exceeded.

**Remarks 1.** Unless specified otherwise, the characteristics of alternate-function pins are the same as those of the port pins.

**2.**  $AV_{REF(+)}$ : + side reference voltage of the A/D converter.

**3.**  $V_{SS}$ : Reference voltage

**Absolute Maximum Ratings ( $T_A = 25^{\circ}\text{C}$ ) (2/2)**

Parameter	Symbols	Conditions		Ratings	Unit
Output current, high	$I_{OH1}$	Per pin	P00 to P06, P10 to P16, P30, P31, P40 to P43, P50, P51, P70 to P77, P120, P130, P140, P141	-40	mA
		Total of all pins -170 mA	P00 to P04, P40 to P43, P120, P130, P140, P141	-70	mA
			P05, P06, P10 to P16, P30, P31, P50, P51, P70 to P77,	-100	mA
	$I_{OH2}$	Per pin	P20 to P27, P150 to P154	-0.1	mA
		Total of all pins		-1.3	mA
	Output current, low	$I_{OL1}$	Per pin	P00 to P06, P10 to P16, P30, P31, P40 to P43, P50, P51, P60 to P63, P70 to P77, P120, P130, P140, P141	40
Total of all pins 170 mA			P00 to P04, P40 to P43, P120, P130, P140, P141	70	mA
			P05, P06, P10 to P16, P30, P31, P50, P51, P60 to P63, P70 to P77	100	mA
$I_{OL2}$		Per pin	P20 to P27, P150 to P154	0.4	mA
		Total of all pins		6.4	mA
Operating ambient temperature		$T_A$	In normal operation mode		-40 to +105
	In flash memory programming mode				
Storage temperature	$T_{stg}$			-65 to +150	$^{\circ}\text{C}$

**Caution** Product quality may suffer if the absolute maximum rating is exceeded even momentarily for any parameter. That is, the absolute maximum ratings are rated values at which the product is on the verge of suffering physical damage, and therefore the product must be used under conditions that ensure that the absolute maximum ratings are not exceeded.

**Remark** Unless specified otherwise, the characteristics of alternate-function pins are the same as those of the port pins.

## 3.2 Oscillator Characteristics

### 3.2.1 X1, XT1 oscillator characteristics

( $T_A = -40$  to  $+105^\circ\text{C}$ ,  $2.4\text{ V} \leq V_{DD} \leq 3.6\text{ V}$ ,  $V_{SS} = 0\text{ V}$ )

Parameter	Resonator	Conditions	MIN.	TYP.	MAX.	Unit
X1 clock oscillation frequency ( $f_x$ ) <sup>Note</sup>	Ceramic resonator/crystal resonator	$2.7\text{ V} \leq V_{DD} \leq 3.6\text{ V}$	1.0		20.0	MHz
		$2.4\text{ V} \leq V_{DD} < 2.7\text{ V}$	1.0		16.0	
XT1 clock oscillation frequency ( $f_x$ ) <sup>Note</sup>	Crystal resonator		32	32.768	35	kHz

**Note** Indicates only permissible oscillator frequency ranges. See AC Characteristics for instruction execution time. Request evaluation by the manufacturer of the oscillator circuit mounted on a board to check the oscillator characteristics.

<R> **Caution** Since the CPU is started by the high-speed on-chip oscillator clock after a reset release, check the X1 clock oscillation stabilization time using the oscillation stabilization time counter status register (OSTC) by the user. Determine the oscillation stabilization time of the OSTC register and the oscillation stabilization time select register (OSTS) after sufficiently evaluating the oscillation stabilization time with the resonator to be used.

### 3.2.2 On-chip oscillator characteristics

( $T_A = -40$  to  $+105^\circ\text{C}$ ,  $2.4\text{ V} \leq V_{DD} \leq 3.6\text{ V}$ ,  $V_{SS} = 0\text{ V}$ )

Oscillators	Parameters	Conditions		MIN.	TYP.	MAX.	Unit
High-speed on-chip oscillator oscillation frequency <sup>Notes 1, 2</sup>	$f_{IH}$			1		32	MHz
High-speed on-chip oscillator oscillation frequency accuracy		+85 to +105 °C	$2.4\text{ V} \leq V_{DD} \leq 3.6\text{ V}$	-2		+2	%
		-20 to +85 °C	$2.4\text{ V} \leq V_{DD} \leq 3.6\text{ V}$	-1		+1	%
		-40 to -20 °C	$2.4\text{ V} \leq V_{DD} \leq 3.6\text{ V}$	-1.5		+1.5	%
Low-speed on-chip oscillator oscillation frequency	$f_{IL}$				15		kHz
Low-speed on-chip oscillator oscillation frequency accuracy				-15		+15	%

**Notes 1.** High-speed on-chip oscillator frequency is selected by bits 0 to 3 of option byte (000C2H/010C2H) and bits 0 to 2 of HOCODIV register.

**2.** This indicates the oscillator characteristics only. See AC Characteristics for instruction execution time.

### 3.3 DC Characteristics

#### 3.3.1 Pin characteristics

<R> ( $T_A = -40$  to  $+105^\circ\text{C}$ ,  $2.4\text{ V} \leq AV_{DD} \leq V_{DD} \leq 3.6\text{ V}$ ,  $2.4\text{ V} \leq EV_{DD0} \leq V_{DD} \leq 3.6\text{ V}$ ,  $V_{SS} = EV_{SS0} = 0\text{ V}$ ) (1/5)

Items	Symbol	Conditions	MIN.	TYP.	MAX.	Unit	
Output current, high <sup>Note 1</sup>	I <sub>OH1</sub>	Per pin for P00 to P06, P10 to P16, P30, P31, P40 to P43, P50, P51, P70 to P77, P120, P130, P140, P141	$2.4\text{ V} \leq EV_{DD0} \leq 3.6\text{ V}$			-3.0 <sup>Note 2</sup>	mA
		Total of P00 to P04, P40 to P43, P120, P130, P140, P141 (When duty $\leq 70\%$ <sup>Note 3</sup> )	$2.7\text{ V} \leq EV_{DD0} \leq 3.6\text{ V}$			-10.0	mA
			$2.4\text{ V} \leq EV_{DD0} < 2.7\text{ V}$			-5.0	mA
		Total of P05, P06, P10 to P16, P30, P31, P50, P51, P70 to P77, (When duty $\leq 70\%$ <sup>Note 3</sup> )	$2.7\text{ V} \leq EV_{DD0} \leq 3.6\text{ V}$			-19.0	mA
			$2.4\text{ V} \leq EV_{DD0} < 2.7\text{ V}$			-10.0	mA
	Total of all pins (When duty $\leq 70\%$ <sup>Note 3</sup> )	$2.4\text{ V} \leq EV_{DD0} \leq 3.6\text{ V}$			-29.0	mA	
	I <sub>OH2</sub>	Per pin for P20 to P27, P150 to P154	$2.4\text{ V} \leq AV_{DD} \leq 3.6\text{ V}$			-0.1 <sup>Note 2</sup>	mA
		Total of all pins (When duty $\leq 70\%$ <sup>Note 3</sup> )	$2.4\text{ V} \leq AV_{DD} \leq 3.6\text{ V}$			-1.3	mA

**Notes 1.** Value of current at which the device operation is guaranteed even if the current flows from the EV<sub>DD0</sub>, V<sub>DD</sub> pins to an output pin.

**2.** However, do not exceed the total current value.

**3.** Specification under conditions where the duty factor  $\leq 70\%$ .

The output current value that has changed to the duty factor  $> 70\%$  the duty ratio can be calculated with the following expression (when changing the duty factor from 70% to n%).

- Total output current of pins =  $(I_{OH} \times 0.7)/(n \times 0.01)$

<Example> Where  $n = 80\%$  and  $I_{OH} = -10.0\text{ mA}$

$$\text{Total output current of pins} = (-10.0 \times 0.7)/(80 \times 0.01) \cong -8.7\text{ mA}$$

However, the current that is allowed to flow into one pin does not vary depending on the duty factor. A current higher than the absolute maximum rating must not flow into one pin.

**Caution** P00, P02 to P04, P10 to P15, P43, P50, P71, and P74 do not output high level in N-ch open-drain mode.

**Remark** Unless specified otherwise, the characteristics of alternate-function pins are the same as those of the port pins.

<R> ( $T_A = -40$  to  $+105^\circ\text{C}$ ,  $2.4\text{ V} \leq AV_{DD} \leq V_{DD} \leq 3.6\text{ V}$ ,  $2.4\text{ V} \leq EV_{DD0} \leq V_{DD} \leq 3.6\text{ V}$ ,  $V_{SS} = EV_{SS0} = 0\text{ V}$ ) (2/5)

Items	Symbol	Conditions	MIN.	TYP.	MAX.	Unit	
Output current, $I_{OL}$ <sup>Note 1</sup>	I <sub>OL1</sub>	Per pin for P00 to P06, P10 to P16, P30, P31, P40 to P43, P50, P51, P70 to P77, P120, P130, P140, P141			8.5 <sup>Note 2</sup>	mA	
		Per pin for P60 to P63			15.0 <sup>Note 2</sup>	mA	
		Total of P00 to P04, P40 to P43, P120, P130, P140, P141 (When duty $\leq 70\%$ <sup>Note 3</sup> )	$2.7\text{ V} \leq EV_{DD0} \leq 3.6\text{ V}$			15.0	mA
			$2.4\text{ V} \leq EV_{DD0} < 2.7\text{ V}$			9.0	mA
		Total of P05, P06, P10 to P16, P30, P31, P50, P51, P60 to P63, P70 to P77 (When duty $\leq 70\%$ <sup>Note 3</sup> )	$2.7\text{ V} \leq EV_{DD0} \leq 3.6\text{ V}$			35.0	mA
			$2.4\text{ V} \leq EV_{DD0} < 2.7\text{ V}$			20.0	mA
	Total of all pins (When duty $\leq 70\%$ <sup>Note 3</sup> )				50.0	mA	
	I <sub>OL2</sub>	Per pin for P20 to P27, P150 to P154				0.4 <sup>Note 2</sup>	mA
Total of all pins (When duty $\leq 70\%$ <sup>Note 3</sup> )		$2.4\text{ V} \leq AV_{DD} \leq 3.6\text{ V}$			5.2	mA	

- Notes**
- Value of current at which the device operation is guaranteed even if the current flows from an output pin to the  $EV_{SS0}$  and  $V_{SS}$  pin.
  - However, do not exceed the total current value.
  - Specification under conditions where the duty factor  $\leq 70\%$ .

The output current value that has changed to the duty factor  $> 70\%$  the duty ratio can be calculated with the following expression (when changing the duty factor from 70% to n%).

- Total output current of pins =  $(I_{OL} \times 0.7)/(n \times 0.01)$

<Example> Where  $n = 80\%$  and  $I_{OL} = 10.0\text{ mA}$

$$\text{Total output current of pins} = (10.0 \times 0.7)/(80 \times 0.01) \cong 8.7\text{ mA}$$

However, the current that is allowed to flow into one pin does not vary depending on the duty factor. A current higher than the absolute maximum rating must not flow into one pin.

**Remark** Unless specified otherwise, the characteristics of alternate-function pins are the same as those of the port pins.

**( $T_A = -40$  to  $+105^\circ\text{C}$ ,  $2.4\text{ V} \leq AV_{DD} \leq V_{DD} \leq 3.6\text{ V}$ ,  $2.4\text{ V} \leq EV_{DD0} \leq V_{DD} \leq 3.6\text{ V}$ ,  $V_{SS} = EV_{SS0} = 0\text{ V}$ )** **(3/5)**

Items	Symbol	Conditions	MIN.	TYP.	MAX.	Unit	
Input voltage, high	$V_{IH1}$	P00 to P06, P10 to P16, P30, P31, P40 to P43, P50, P51, P70 to P77, P120, P140, P141	Normal input buffer	$0.8EV_{DD0}$		$EV_{DD0}$	V
	$V_{IH2}$	P01, P03, P04, P10, P11, P13 to P16, P43	TTL input buffer $3.3\text{ V} \leq EV_{DD0} \leq 3.6\text{ V}$	2.0		$EV_{DD0}$	V
			TTL input buffer $2.4\text{ V} \leq EV_{DD0} < 3.3\text{ V}$	1.5		$EV_{DD0}$	V
	$V_{IH3}$	P20 to P27, P150 to P154		$0.7AV_{DD}$		$AV_{DD}$	V
	$V_{IH4}$	P60 to P63		$0.7EV_{DD0}$		6.0	V
	$V_{IH5}$	P121 to P124, P137, EXCLK, EXCLKS, $\overline{\text{RESET}}$		$0.8V_{DD}$		$V_{DD}$	V
Input voltage, low	$V_{IL1}$	P00 to P06, P10 to P16, P30, P31, P40 to P43, P50, P51, P70 to P77, P120, P140, P141	Normal input buffer	0		$0.2EV_{DD0}$	V
	$V_{IL2}$	P01, P03, P04, P10, P11, P13 to P16, P43	TTL input buffer $3.3\text{ V} \leq EV_{DD0} \leq 3.6\text{ V}$	0		0.5	V
			TTL input buffer $2.4\text{ V} \leq EV_{DD0} < 3.3\text{ V}$	0		0.32	V
	$V_{IL3}$	P20 to P27, P150 to P154		0		$0.3AV_{DD}$	V
	$V_{IL4}$	P60 to P63		0		$0.3EV_{DD0}$	V
	$V_{IL5}$	P121 to P124, P137, EXCLK, EXCLKS, $\overline{\text{RESET}}$		0		$0.2V_{DD}$	V

**Caution** The maximum value of  $V_{IH}$  of pins P00, P02 to P04, P10 to P15, P43, P50, P71, and P74 is  $EV_{DD0}$ , even in the N-ch open-drain mode.

**Remark** Unless specified otherwise, the characteristics of alternate-function pins are the same as those of the port pins.



**( $T_A = -40$  to  $+105^\circ\text{C}$ ,  $2.4\text{ V} \leq AV_{DD} \leq V_{DD} \leq 3.6\text{ V}$ ,  $2.4\text{ V} \leq EV_{DD0} \leq V_{DD} \leq 3.6\text{ V}$ ,  $V_{SS} = EV_{SS0} = 0\text{ V}$ )** **(4/5)**

Items	Symbol	Conditions	MIN.	TYP.	MAX.	Unit
Output voltage, high	V <sub>OH1</sub>	P00 to P06, P10 to P16, P30, P31, P40 to P43, P50, P51, P70 to P77, P120, P130, P140, P141	$2.7\text{ V} \leq EV_{DD0} \leq 3.6\text{ V}$ , $I_{OH1} = -2.0\text{ mA}$	$EV_{DD0} - 0.6$		V
			$2.4\text{ V} \leq EV_{DD0} \leq 3.6\text{ V}$ , $I_{OH1} = -1.5\text{ mA}$	$EV_{DD0} - 0.5$		V
	V <sub>OH2</sub>	P20 to P27, P150 to P154	$2.4\text{ V} \leq AV_{DD} \leq 3.6\text{ V}$ , $I_{OH2} = -100\ \mu\text{A}$	$AV_{DD} - 0.5$		V
Output voltage, low	V <sub>OL1</sub>	P00 to P06, P10 to P16, P30, P31, P40 to P43, P50, P51, P70 to P77, P120, P130, P140, P141	$2.7\text{ V} \leq EV_{DD0} \leq 3.6\text{ V}$ , $I_{OL1} = 3.0\text{ mA}$		0.6	V
			$2.7\text{ V} \leq EV_{DD0} \leq 3.6\text{ V}$ , $I_{OL1} = 1.5\text{ mA}$		0.4	V
			$2.4\text{ V} \leq EV_{DD0} \leq 3.6\text{ V}$ , $I_{OL1} = 0.6\text{ mA}$		0.4	V
	V <sub>OL2</sub>	P20 to P27, P150 to P154	$2.4\text{ V} \leq AV_{DD} \leq 3.6\text{ V}$ , $I_{OL2} = 400\ \mu\text{A}$		0.4	V
	V <sub>OL3</sub>	P60 to P63	$2.7\text{ V} \leq EV_{DD0} \leq 3.6\text{ V}$ , $I_{OL3} = 3.0\text{ mA}$		0.4	V
			$2.4\text{ V} \leq EV_{DD0} \leq 3.6\text{ V}$ , $I_{OL3} = 2.0\text{ mA}$		0.4	V

**Caution** P00, P02 to P04, P10 to P15, P43, P50, P71, and P74 do not output high level in N-ch open-drain mode.

**Remark** Unless specified otherwise, the characteristics of alternate-function pins are the same as those of the port pins.

**( $T_A = -40$  to  $+105^\circ\text{C}$ ,  $2.4\text{ V} \leq AV_{DD} \leq V_{DD} \leq 3.6\text{ V}$ ,  $2.4\text{ V} \leq EV_{DD0} \leq V_{DD} \leq 3.6\text{ V}$ ,  $V_{SS} = EV_{SS0} = 0\text{ V}$ ) (5/5)**

Items	Symbol	Conditions	MIN.	TYP.	MAX.	Unit		
Input leakage current, high	I <sub>LIH1</sub>	P00 to P06, P10 to P16, P30, P31, P40 to P43, P50, P51, P60 to P63, P70 to P77, P120, P140, P141	$V_i = EV_{DD0}$		1	$\mu\text{A}$		
	I <sub>LIH2</sub>	P137, $\overline{\text{RESET}}$	$V_i = V_{DD}$		1	$\mu\text{A}$		
	I <sub>LIH3</sub>	P121 to P124 (X1, X2, XT1, XT2, EXCLK, EXCLKS)	$V_i = V_{DD}$	In input port or external clock input		1	$\mu\text{A}$	
				In resonator connection		10	$\mu\text{A}$	
	I <sub>LIH4</sub>	P20 to P27, P150 to P154	$V_i = AV_{DD}$		1	$\mu\text{A}$		
Input leakage current, low	I <sub>LIL1</sub>	P00 to P06, P10 to P16, P30, P31, P40 to P43, P50, P51, P60 to P67, P70 to P77, P120, P140, P141	$V_i = EV_{SS0}$		-1	$\mu\text{A}$		
	I <sub>LIL2</sub>	P137, $\overline{\text{RESET}}$	$V_i = V_{SS}$		-1	$\mu\text{A}$		
	I <sub>LIL3</sub>	P121 to P124 (X1, X2, XT1, XT2, EXCLK, EXCLKS)	$V_i = V_{SS}$	In input port or external clock input		-1	$\mu\text{A}$	
				In resonator connection		-10	$\mu\text{A}$	
	I <sub>LIL4</sub>	P20 to P27, P150 to P154	$V_i = AV_{SS}$		-1	$\mu\text{A}$		
On-chip pull-up resistance	R <sub>U</sub>	P00 to P06, P10 to P16, P30, P31, P40 to P43, P50, P51, P70 to P77, P120, P140, P141	$V_i = EV_{SS0}$ , In input port		10	20	100	k $\Omega$

**Remark** Unless specified otherwise, the characteristics of alternate-function pins are the same as those of the port pins.

## 3.3.2 Supply current characteristics

 $(T_A = -40$  to  $+105^\circ\text{C}$ ,  $2.4\text{ V} \leq V_{DD0} \leq V_{DD} \leq 3.6\text{ V}$ ,  $V_{SS} = V_{SS0} = 0\text{ V}$ )

(1/3)

Parameter	Symbol	Conditions				MIN.	TYP.	MAX.	Unit	
Supply current	$I_{DD1}$ <sup>Note 1</sup>	Operating mode	HS (high-speed main) mode <sup>Note 5</sup>	$f_{IH} = 32\text{ MHz}$ <sup>Note 3</sup>	Basic operation	$V_{DD} = 3.0\text{ V}$		2.1		mA
					Normal operation	$V_{DD} = 3.0\text{ V}$		4.6	7.5	mA
				$f_{IH} = 24\text{ MHz}$ <sup>Note 3</sup>	Normal operation	$V_{DD} = 3.0\text{ V}$		3.7	5.8	mA
					Normal operation	$V_{DD} = 3.0\text{ V}$		2.7	4.2	mA
			HS (high-speed main) mode <sup>Note 5</sup>	$f_{MX} = 20\text{ MHz}$ <sup>Note 2</sup> , $V_{DD} = 3.0\text{ V}$	Normal operation	Square wave input		3.0	4.9	mA
						Resonator connection		3.2	5.0	
				$f_{MX} = 10\text{ MHz}$ <sup>Note 2</sup> , $V_{DD} = 3.0\text{ V}$	Normal operation	Square wave input		1.9	2.9	mA
						Resonator connection		1.9	2.9	
			Subsystem clock mode	$f_{SUB} = 32.768\text{ kHz}$ <sup>Note 4</sup> $T_A = -40^\circ\text{C}$	Normal operation	Square wave input		4.1	4.9	$\mu\text{A}$
						Resonator connection		4.2	5.0	
				$f_{SUB} = 32.768\text{ kHz}$ <sup>Note 4</sup> $T_A = +25^\circ\text{C}$	Normal operation	Square wave input		4.2	4.9	$\mu\text{A}$
						Resonator connection		4.3	5.0	
				$f_{SUB} = 32.768\text{ kHz}$ <sup>Note 4</sup> $T_A = +50^\circ\text{C}$	Normal operation	Square wave input		4.3	5.5	$\mu\text{A}$
						Resonator connection		4.4	5.6	
				$f_{SUB} = 32.768\text{ kHz}$ <sup>Note 4</sup> $T_A = +70^\circ\text{C}$	Normal operation	Square wave input		4.5	6.3	$\mu\text{A}$
						Resonator connection		4.6	6.4	
$f_{SUB} = 32.768\text{ kHz}$ <sup>Note 4</sup> $T_A = +85^\circ\text{C}$	Normal operation	Square wave input		4.8	7.7	$\mu\text{A}$				
		Resonator connection		4.9	7.8					
$f_{SUB} = 32.768\text{ kHz}$ <sup>Note 4</sup> $T_A = +105^\circ\text{C}$	Normal operation	Square wave input		6.9	19.7	$\mu\text{A}$				
		Resonator connection		7.0	19.8					

(Notes and Remarks are listed on the next page.)

- Notes**
1. Total current flowing into  $V_{DD}$  and  $EV_{DD0}$ , including the input leakage current flowing when the level of the input pin is fixed to  $V_{DD}$ ,  $EV_{DD0}$  or  $V_{SS}$ ,  $EV_{SS0}$ . The values below the MAX. column include the peripheral operation current. However, not including the current flowing into the A/D converter, LVD circuit, I/O port, on-chip pull-up/pull-down resistors, and data flash rewriting.
  2. When high-speed on-chip oscillator and subsystem clock are stopped.
  3. When high-speed system clock and subsystem clock are stopped.
  4. When high-speed on-chip oscillator and high-speed system clock are stopped. When setting ultra-low power consumption oscillation ( $AMP_{HS1} = 1$ ). Not including the current flowing into the RTC, 12-bit interval timer and watchdog timer
  5. Relationship between operation voltage width, operation frequency of CPU and operation mode is as below.  
HS (high-speed main) mode:  $V_{DD} = 2.7\text{ V to }3.6\text{ V@1 MHz to }32\text{ MHz}$   
 $V_{DD} = 2.4\text{ V to }3.6\text{ V@1 MHz to }16\text{ MHz}$

- Remarks**
1.  $f_{MX}$ : High-speed system clock frequency (X1 clock oscillation frequency or external main system clock frequency)
  2.  $f_{IH}$ : High-speed on-chip oscillator clock frequency
  3.  $f_{SUB}$ : Subsystem clock frequency (XT1 clock oscillation frequency)
  4. Except subsystem clock operation, temperature condition of the TYP. value is  $T_A = 25^\circ\text{C}$

**( $T_A = -40$  to  $+105^\circ\text{C}$ ,  $2.4\text{ V} \leq EV_{DD0} \leq V_{DD} \leq 3.6\text{ V}$ ,  $V_{SS} = EV_{SS0} = 0\text{ V}$ )****(2/3)**

Parameter	Symbol	Conditions		MIN.	TYP.	MAX.	Unit		
Supply current <sup>Note 1</sup>	$I_{DD2}$ <sup>Note 2</sup>	HALT mode	HS (high-speed main) mode <sup>Note 7</sup>	$f_{IH} = 32\text{ MHz}$ <sup>Note 4</sup>	$V_{DD} = 3.0\text{ V}$		0.54	2.90	mA
				$f_{IH} = 24\text{ MHz}$ <sup>Note 4</sup>	$V_{DD} = 3.0\text{ V}$		0.44	2.30	mA
				$f_{IH} = 16\text{ MHz}$ <sup>Note 4</sup>	$V_{DD} = 3.0\text{ V}$		0.40	1.70	mA
			HS (high-speed main) mode <sup>Note 7</sup>	$f_{MX} = 20\text{ MHz}$ <sup>Note 3</sup> , $V_{DD} = 3.0\text{ V}$	Square wave input		0.28	1.90	mA
					Resonator connection		0.45	2.00	
				$f_{MX} = 10\text{ MHz}$ <sup>Note 3</sup> , $V_{DD} = 3.0\text{ V}$	Square wave input		0.19	1.02	mA
					Resonator connection		0.26	1.10	
			Subsystem clock mode	$f_{SUB} = 32.768\text{ kHz}$ <sup>Note 5</sup> $T_A = -40^\circ\text{C}$	Square wave input		0.25	0.57	$\mu\text{A}$
					Resonator connection		0.44	0.76	
				$f_{SUB} = 32.768\text{ kHz}$ <sup>Note 5</sup> $T_A = +25^\circ\text{C}$	Square wave input		0.30	0.57	$\mu\text{A}$
					Resonator connection		0.49	0.76	
				$f_{SUB} = 32.768\text{ kHz}$ <sup>Note 5</sup> $T_A = +50^\circ\text{C}$	Square wave input		0.38	1.17	$\mu\text{A}$
					Resonator connection		0.57	1.36	
				$f_{SUB} = 32.768\text{ kHz}$ <sup>Note 5</sup> $T_A = +70^\circ\text{C}$	Square wave input		0.52	1.97	$\mu\text{A}$
					Resonator connection		0.71	2.16	
			$f_{SUB} = 32.768\text{ kHz}$ <sup>Note 5</sup> $T_A = +85^\circ\text{C}$	Square wave input		0.97	3.37	$\mu\text{A}$	
				Resonator connection		1.16	3.56		
$f_{SUB} = 32.768\text{ kHz}$ <sup>Note 5</sup> $T_A = +105^\circ\text{C}$	Square wave input		3.01	15.37	$\mu\text{A}$				
	Resonator connection		3.20	15.56					
$I_{DD3}$ <sup>Note 6</sup>	STOP mode <sup>Note 8</sup>	$T_A = -40^\circ\text{C}$			0.16	0.50	$\mu\text{A}$		
		$T_A = +25^\circ\text{C}$			0.23	0.50			
		$T_A = +50^\circ\text{C}$			0.34	1.10			
		$T_A = +70^\circ\text{C}$			0.46	1.90			
		$T_A = +85^\circ\text{C}$			0.75	3.30			
		$T_A = +105^\circ\text{C}$			2.94	15.30			

(Notes and Remarks are listed on the next page.)

- Notes**
1. Total current flowing into  $V_{DD}$  and  $EV_{DD0}$ , including the input leakage current flowing when the level of the input pin is fixed to  $V_{DD}$ ,  $EV_{DD0}$  or  $V_{SS}$ ,  $EV_{SS0}$ . The values below the MAX. column include the peripheral operation current. However, not including the current flowing into the A/D converter, LVD circuit, I/O port, on-chip pull-up/pull-down resistors, and data flash rewriting.
  2. During HALT instruction execution by flash memory.
  3. When high-speed on-chip oscillator and subsystem clock are stopped.
  4. When high-speed system clock and subsystem clock are stopped.
  5. When high-speed on-chip oscillator and high-speed system clock are stopped. When  $RTCLPC = 1$  and setting ultra-low current consumption ( $AMPHS1 = 1$ ). Including the current flowing into the RTC. However, not including the current flowing into the 12-bit interval timer, and watchdog timer.
  6. When subsystem clock is stopped. Not including the current flowing into the RTC, 12-bit interval timer, watchdog timer.
  7. Relationship between operation voltage width, operation frequency of CPU and operation mode is as below.
    - HS (high-speed main) mode:  $2.7\text{ V} \leq V_{DD} \leq 3.6\text{ V}@1\text{ MHz to }32\text{ MHz}$   
 $2.4\text{ V} \leq V_{DD} \leq 3.6\text{ V}@1\text{ MHz to }16\text{ MHz}$
  8. Regarding the value for current to operate the subsystem clock in STOP mode, refer to that in HALT mode.

- Remarks**
1.  $f_{MX}$ : High-speed system clock frequency (X1 clock oscillation frequency or external main system clock frequency)
  2.  $f_{IH}$ : High-speed on-chip oscillator clock frequency
  3.  $f_{SUB}$ : Subsystem clock frequency (XT1 clock oscillation frequency)
  4. Except subsystem clock operation and STOP mode, temperature condition of the TYP. value is  $T_A = 25^\circ\text{C}$

**( $T_A = -40$  to  $+105^\circ\text{C}$ ,  $2.4\text{ V} \leq \text{EV}_{\text{DD}0} \leq \text{V}_{\text{DD}} \leq 3.6\text{ V}$ ,  $\text{V}_{\text{SS}} = \text{EV}_{\text{SS}0} = 0\text{ V}$ )****(3/3)**

Parameter	Symbol	Conditions	MIN.	TYP.	MAX.	Unit
Low-speed on-chip oscillator operating current	$I_{\text{FIL}}$ <sup>Note 1</sup>			0.20		$\mu\text{A}$
RTC operating current	$I_{\text{RTC}}$ <sup>Notes 1, 2, 3</sup>			0.02		$\mu\text{A}$
12-bit interval timer operating current	$I_{\text{IT}}$ <sup>Notes 1, 2, 4</sup>			0.02		$\mu\text{A}$
Watchdog timer operating current	$I_{\text{WDT}}$ <sup>Notes 1, 2, 5</sup>	$f_{\text{IL}} = 15\text{ kHz}$		0.22		$\mu\text{A}$
A/D converter operating current	$I_{\text{ADC}}$ <sup>Notes 6, 7</sup>	$\text{AV}_{\text{DD}} = 3.0\text{ V}$ , When conversion at maximum speed		420	720	$\mu\text{A}$
AVREF(+) current	$I_{\text{AVREF}}$ <sup>Note 8</sup>	$\text{AV}_{\text{DD}} = 3.0\text{ V}$ , $\text{ADREFP1} = 0$ , $\text{ADREFP0} = 0$ <sup>Note 7</sup>		14.0	25.0	$\mu\text{A}$
		$\text{AV}_{\text{REFP}} = 3.0\text{ V}$ , $\text{ADREFP1} = 0$ , $\text{ADREFP0} = 1$ <sup>Note 10</sup>		14.0	25.0	$\mu\text{A}$
		$\text{ADREFP1} = 1$ , $\text{ADREFP0} = 0$ <sup>Note 1</sup>		14.0	25.0	$\mu\text{A}$
A/D converter reference voltage current	$I_{\text{ADREF}}$ <sup>Notes 1, 9</sup>	$\text{V}_{\text{DD}} = 3.0\text{ V}$		75.0		$\mu\text{A}$
Temperature sensor operating current	$I_{\text{TMP5}}$ <sup>Note 1</sup>	$\text{V}_{\text{DD}} = 3.0\text{ V}$		75.0		$\mu\text{A}$
LVD operating current	$I_{\text{LVD}}$ <sup>Notes 1, 11</sup>			0.08		$\mu\text{A}$
BGO operating current	$I_{\text{BGO}}$ <sup>Notes 1, 12</sup>			2.5	12.2	$\text{mA}$
Self-programming operating current	$I_{\text{FSP}}$ <sup>Notes 1, 13</sup>			2.5	12.2	$\text{mA}$
SNOOZE operating current	$I_{\text{SNOZ}}$	A/D converter operation ( $\text{AV}_{\text{DD}} = 3.0\text{ V}$ )	The mode is performed <sup>Notes 1, 14</sup>	0.50	1.10	$\text{mA}$
			During A/D conversion <sup>Note 1</sup>	0.60	1.34	$\text{mA}$
			During A/D conversion <sup>Note 7</sup>	420	720	$\mu\text{A}$
		CSI/UART operation <sup>Note 1</sup>	0.70	1.54	$\text{mA}$	

(Notes and Remarks are listed on the next page.)

- <R> **Notes**
1. Current flowing to  $V_{DD}$ .
  2. When high-speed on-chip oscillator and high-speed system clock are stopped.
  3. Current flowing only to the real-time clock (RTC) (excluding the operating current of the low-speed on-chip oscillator and the XT1 oscillator). The supply current of the RL78 microcontrollers is the sum of the values of either  $I_{DD1}$  or  $I_{DD2}$ , and  $I_{RTC}$ , when the real-time clock operates in operation mode or HALT mode. When the low-speed on-chip oscillator is selected,  $I_{FIL}$  should be added.  $I_{DD2}$  subsystem clock operation includes the operational current of the real-time clock.
  4. Current flowing only to the 12-bit interval timer (excluding the operating current of the low-speed on-chip oscillator and the XT1 oscillator). The supply current of the RL78 microcontrollers is the sum of the values of either  $I_{DD1}$  or  $I_{DD2}$ , and  $I_{IT}$ , when the 12-bit interval timer operates in operation mode or HALT mode. When the low-speed on-chip oscillator is selected,  $I_{FIL}$  should be added.
  5. Current flowing only to the watchdog timer (including the operating current of the low-speed on-chip oscillator). The supply current of the RL78 microcontrollers is the sum of  $I_{DD1}$ ,  $I_{DD2}$ , or  $I_{DD3}$  and  $I_{WDT}$  when the watchdog timer is in operation.
  6. Current flowing only to the A/D converter. The supply current of the RL78 microcontrollers is the sum of  $I_{DD1}$  or  $I_{DD2}$  and  $I_{ADC}$ ,  $I_{AVREF}$ ,  $I_{ADREF}$  when the A/D converter operates in an operation mode or the HALT mode.
  7. Current flowing to the  $AV_{DD}$ .
  8. Current flowing from the reference voltage source of A/D converter.
  9. Operation current flowing to the internal reference voltage.
  10. Current flowing to the  $AV_{REFP}$ .
  11. Current flowing only to the LVD circuit. The supply current of the RL78 microcontrollers is the sum of  $I_{DD1}$ ,  $I_{DD2}$  or  $I_{DD3}$  and  $I_{LVD}$  when the LVD circuit is in operation.
  12. Current flowing only during data flash rewrite.
  13. Current flowing only during self programming.

- Remarks**
1.  $f_{IL}$ : Low-speed on-chip oscillator clock frequency
  2.  $f_{SUB}$ : Subsystem clock frequency (XT1 clock oscillation frequency)
  3.  $f_{CLK}$ : CPU/peripheral hardware clock frequency
  4. Temperature condition of the TYP. value is  $T_A = 25^\circ\text{C}$



## 3.4 AC Characteristics

(T<sub>A</sub> = -40 to +105°C, AV<sub>DD</sub> ≤ V<sub>DD</sub> ≤ 3.6 V, 2.4 V ≤ EV<sub>DD0</sub> ≤ V<sub>DD</sub> ≤ 3.6 V, V<sub>SS</sub> = EV<sub>SS0</sub> = 0 V)

Items	Symbol	Conditions		MIN.	TYP.	MAX.	Unit	
Instruction cycle (minimum instruction execution time)	T <sub>cy</sub>	Main system clock (f <sub>MAIN</sub> ) operation	HS (high-speed main) mode	2.7 V ≤ V <sub>DD</sub> ≤ 3.6 V	0.03125	1	μs	
				2.4 V ≤ V <sub>DD</sub> < 2.7 V	0.0625	1	μs	
		Subsystem clock (f <sub>SUB</sub> ) operation		2.4 V ≤ V <sub>DD</sub> ≤ 3.6 V	28.5	30.5	31.3	μs
		In the self programming mode	HS (high-speed main) mode	2.7 V ≤ V <sub>DD</sub> ≤ 3.6 V	0.03125	1	μs	
				2.4 V ≤ V <sub>DD</sub> < 2.7 V	0.0625	1	μs	
External system clock frequency	f <sub>EX</sub>	2.7 V ≤ V <sub>DD</sub> ≤ 3.6 V		1.0		20.0	MHz	
		2.4 V ≤ V <sub>DD</sub> < 2.7 V		1.0		16.0	MHz	
	f <sub>EXS</sub>			32		35	kHz	
External system clock input high-level width, low-level width	t <sub>EXH</sub> , t <sub>EXL</sub>	2.7 V ≤ V <sub>DD</sub> ≤ 3.6 V		24			ns	
		2.4 V ≤ V <sub>DD</sub> < 2.7 V		30			ns	
	t <sub>EXHS</sub> , t <sub>EXLS</sub>			13.7			μs	
TI00, TI01, TI03 to TI07 input high-level width, low-level width	t <sub>TIH</sub> , t <sub>TIL</sub>			1/f <sub>MCK</sub> +10			ns <sup>Note</sup>	
TO00, TO01, TO03 to TO07 output frequency	f <sub>TO</sub>	HS (high-speed main) mode	2.7 V ≤ EV <sub>DD0</sub> ≤ 3.6 V			8	MHz	
			2.4 V ≤ EV <sub>DD0</sub> < 2.7 V			4	MHz	
PCLBUZ0, PCLBUZ1 output frequency	f <sub>PCL</sub>	HS (high-speed main) mode	2.7 V ≤ EV <sub>DD0</sub> ≤ 3.6 V			8	MHz	
			2.4 V ≤ EV <sub>DD0</sub> < 2.7 V			4	MHz	
Interrupt input high-level width, low-level width	t <sub>INTH</sub> , t <sub>INTL</sub>	INTP0	2.4 V ≤ V <sub>DD</sub> ≤ 3.6 V	1			μs	
		INTP1 to INTP11	2.4 V ≤ EV <sub>DD0</sub> ≤ 3.6 V	1			μs	
Key interrupt input high-level width, low-level width	t <sub>KR</sub>	KR0 to KR9	2.4 V ≤ EV <sub>DD0</sub> ≤ 3.6 V, 2.4 V ≤ AV <sub>DD0</sub> ≤ 3.6 V	250			ns	
RESET low-level width	t <sub>RSL</sub>			10			μs	

**Note** The following conditions are required for low-voltage interface when EV<sub>DD0</sub> < V<sub>DD</sub>.

2.4 V ≤ EV<sub>DD0</sub> < 2.7 V : MIN. 125 ns

**Remark** f<sub>MCK</sub>: Timer array unit operation clock frequency

(Operation clock to be set by the CKS0n bit of timer clock select register 0 (TPS0) and timer mode register 0n (TMR0n). n: Channel number (n = 0 to 7))

Minimum Instruction Execution Time during Main System Clock Operation

<R>

$T_{CY}$  vs  $V_{DD}$  (HS (high-speed main) mode)

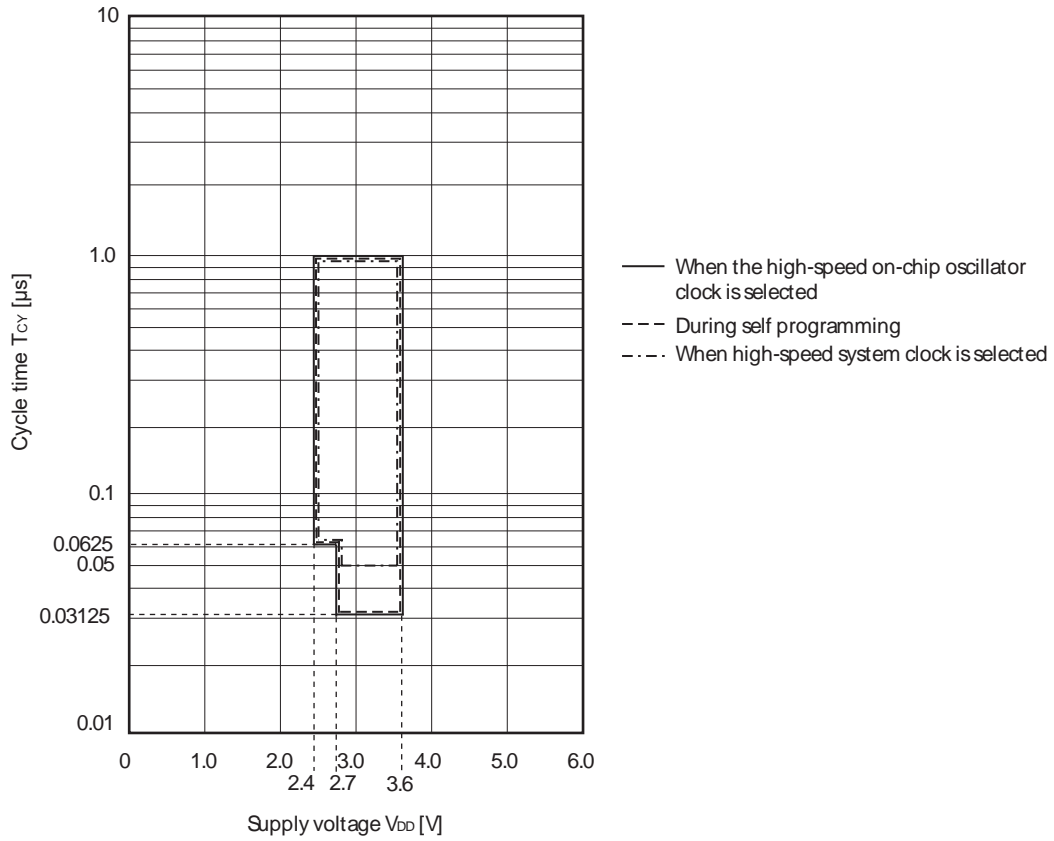

**AC Timing Test Points**

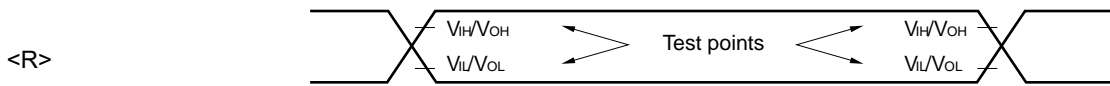

**External System Clock Timing**

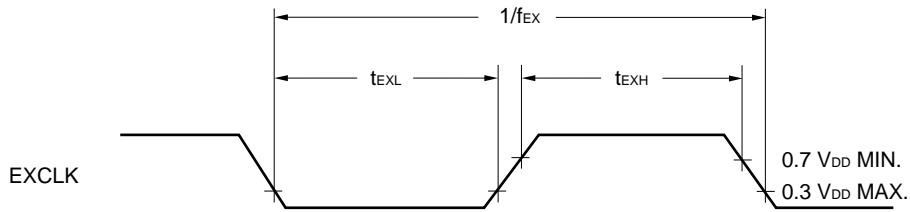

<R> **TI/TO Timing**

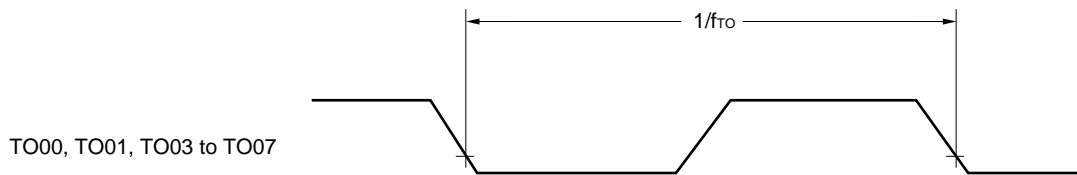
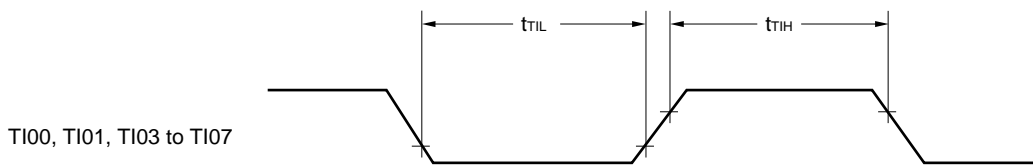

**Interrupt Request Input Timing**

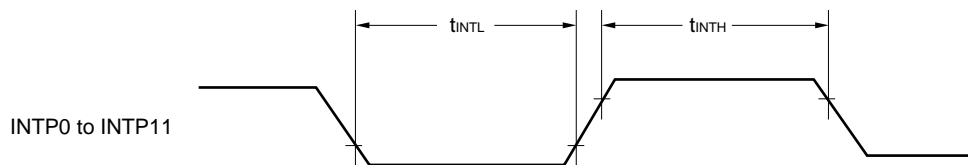

**Key Interrupt Input Timing**

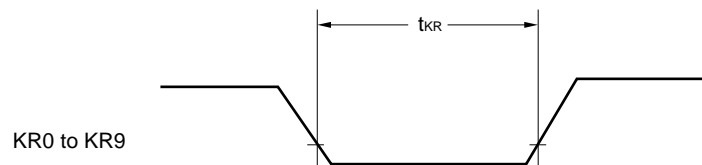

**$\overline{\text{RESET}}$  Input Timing**

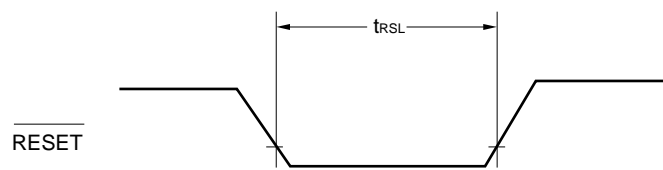

### 3.5 Peripheral Functions Characteristics

#### AC Timing Test Points

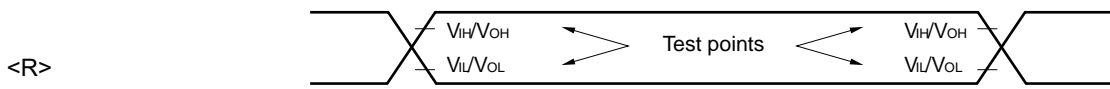

#### 3.5.1 Serial array unit

(1) During communication at same potential (UART mode) (dedicated baud rate generator output)  
 ( $T_A = -40$  to  $+105^\circ\text{C}$ ,  $2.4\text{ V} \leq EV_{DD0} \leq V_{DD} \leq 3.6\text{ V}$ ,  $V_{SS} = EV_{SS0} = 0\text{ V}$ )

Parameter	Symbol	Conditions	MIN.	TYP.	MAX.	Unit
Transfer rate <sup>Note 1</sup>					$f_{MCK}/12$	bps
		Theoretical value of the maximum transfer rate $f_{CLK} = 32\text{ MHz}$ , $f_{MCK} = f_{CLK}$			$2.6^{\text{Note 2}}$	Mbps

- Notes 1.** Transfer rate in the SNOOZE mode is 4800 bps.  
**2.** The following conditions are required for low-voltage interface when  $EV_{DD0} < V_{DD}$ .  
 $2.4\text{ V} \leq EV_{DD0} < 2.7\text{ V}$  : MAX. 1.3 Mbps

**Caution** Select the normal input buffer for the RxDq pin and the normal output mode for the TxDq pin by using port input mode register g (PIMg) and port output mode register g (POMg).

#### UART mode connection diagram (during communication at same potential)

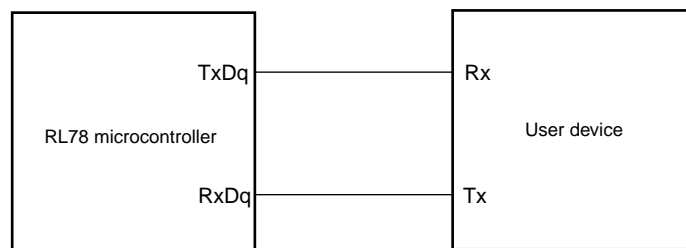

#### UART mode bit width (during communication at same potential) (reference)

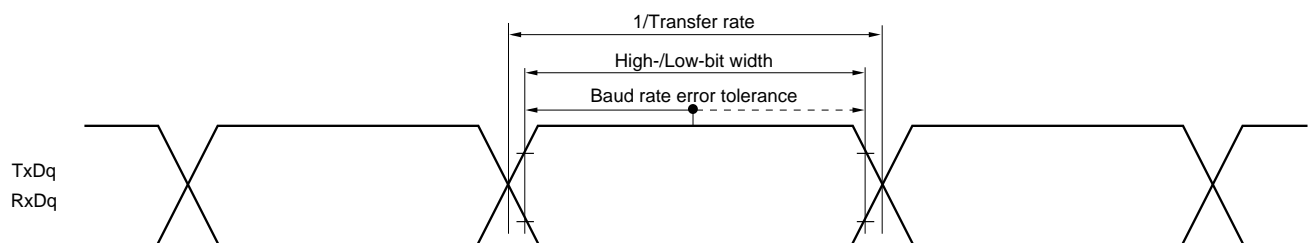

- Remarks 1.** q: UART number (q = 0 to 2), g: PIM and POM number (g = 0, 1)  
**2.**  $f_{MCK}$ : Serial array unit operation clock frequency  
 (Operation clock to be set by the CKSmn bit of serial mode register mn (SMRmn). m: Unit number, n: Channel number (mn = 00 to 03, 10, 11))

**(2) During communication at same potential (CSI mode) (master mode, SCKp... internal clock output)****( $T_A = -40$  to  $+105^\circ\text{C}$ ,  $2.4\text{ V} \leq EV_{DD0} \leq V_{DD} \leq 3.6\text{ V}$ ,  $V_{SS} = EV_{SS0} = 0\text{ V}$ )**

Parameter	Symbol	Conditions	MIN.	TYP.	MAX.	Unit
SCKp cycle time	$t_{KCY1}$	$2.7\text{ V} \leq EV_{DD0} \leq 3.6\text{ V}$ $t_{KCY1} \geq 4/f_{CLK}$	250			ns
		$2.4\text{ V} \leq EV_{DD0} \leq 3.6\text{ V}$ $t_{KCY1} \geq 4/f_{CLK}$	500			ns
SCKp high-/low-level width	$t_{KH1}$ ,	$2.7\text{ V} \leq EV_{DD0} \leq 3.6\text{ V}$	$t_{KCY1}/2 - 36$			ns
	$t_{KL1}$	$2.4\text{ V} \leq EV_{DD0} \leq 3.6\text{ V}$	$t_{KCY1}/2 - 76$			ns
Slp setup time (to SCKp $\uparrow$ ) <sup>Note 1</sup>	$t_{SIK1}$	$2.7\text{ V} \leq EV_{DD0} \leq 3.6\text{ V}$	66			ns
		$2.4\text{ V} \leq EV_{DD0} \leq 3.6\text{ V}$	113			ns
Slp hold time (from SCKp $\uparrow$ ) <sup>Note 1</sup>	$t_{KSI1}$		38			ns
Delay time from SCKp $\downarrow$ to SOp output <sup>Note 2</sup>	$t_{KSO1}$	$C = 30\text{ p}$ <sup>Note 3</sup>			50	ns

**Notes 1.** When  $DAP_{mn} = 0$  and  $CKP_{mn} = 0$ , or  $DAP_{mn} = 1$  and  $CKP_{mn} = 1$ . The Slp setup time or Slp hold time becomes "from SCKp $\downarrow$ " when  $DAP_{mn} = 0$  and  $CKP_{mn} = 1$ , or  $DAP_{mn} = 1$  and  $CKP_{mn} = 0$ .

**2.** When  $DAP_{mn} = 0$  and  $CKP_{mn} = 0$ , or  $DAP_{mn} = 1$  and  $CKP_{mn} = 1$ . The delay time to SOp output becomes "from SCKp $\uparrow$ " when  $DAP_{mn} = 0$  and  $CKP_{mn} = 1$ , or  $DAP_{mn} = 1$  and  $CKP_{mn} = 0$ .

**3.** C is the load capacitance of the SCKp and SOp output lines.

**Caution** Select the normal input buffer for the Slp pin and the normal output mode for the SOp pin and SCKp pin by using port input mode register g (PIMg) and port output mode register g (POMg).

**Remark** p: CSI number (p = 00, 01, 10, 11, 20, 21), m: Unit number (m = 0, 1), n: Channel number (n = 0 to 3), g: PIM and POM numbers (g = 0, 1)

<R> (3) During communication at same potential (CSI mode) (slave mode, SCKp... external clock input)  
 ( $T_A = -40$  to  $+105^\circ\text{C}$ ,  $2.4\text{ V} \leq \text{EV}_{\text{DD0}} \leq \text{V}_{\text{DD}} \leq 3.6\text{ V}$ ,  $\text{V}_{\text{SS}} = \text{EV}_{\text{SS0}} = 0\text{ V}$ )

Parameter	Symbol	Conditions	MIN.	TYP.	MAX.	Unit	
SCKp cycle time <sup>Note 1</sup>	$t_{\text{KCY2}}$	$2.7\text{ V} \leq \text{EV}_{\text{DD0}} \leq 3.6\text{ V}$	$16\text{ MHz} < f_{\text{MCK}}$	$16/f_{\text{MCK}}$		ns	
			$f_{\text{MCK}} \leq 16\text{ MHz}$	$12/f_{\text{MCK}}$		ns	
		$2.4\text{ V} \leq \text{EV}_{\text{DD0}} \leq 3.6\text{ V}$		$12/f_{\text{MCK}}$ and 1000		ns	
SCKp high-/low-level width	$t_{\text{KH2}}$ , $t_{\text{KL2}}$	$2.7\text{ V} \leq \text{EV}_{\text{DD0}} \leq 3.6\text{ V}$		$t_{\text{KCY2}}/2-14$		ns	
		$2.4\text{ V} \leq \text{EV}_{\text{DD0}} \leq 3.6\text{ V}$		$t_{\text{KCY2}}/2-16$		ns	
Slp setup time (to SCKp $\uparrow$ ) <sup>Note 2</sup>	$t_{\text{SIK2}}$	$2.7\text{ V} \leq \text{EV}_{\text{DD0}} \leq 3.6\text{ V}$		$1/f_{\text{MCK}} + 40$		ns	
		$2.4\text{ V} \leq \text{EV}_{\text{DD0}} \leq 3.6\text{ V}$		$1/f_{\text{MCK}} + 60$		ns	
Slp hold time (from SCKp $\uparrow$ ) <sup>Note 2</sup>	$t_{\text{KSI2}}$	$2.7\text{ V} \leq \text{EV}_{\text{DD0}} \leq 3.6\text{ V}$		$1/f_{\text{MCK}}+62$		ns	
		$2.4\text{ V} \leq \text{EV}_{\text{DD0}} \leq 3.6\text{ V}$		$1/f_{\text{MCK}}+62$		ns	
Delay time from SCKp $\downarrow$ to SOp output <sup>Note 3</sup>	$t_{\text{KSO2}}$	$C = 30\text{ pF}$ <sup>Note 4</sup>	$2.7\text{ V} \leq \text{EV}_{\text{DD0}} \leq 3.6\text{ V}$			$2/f_{\text{MCK}}+66$	ns
			$2.4\text{ V} \leq \text{EV}_{\text{DD0}} \leq 3.6\text{ V}$				$2/f_{\text{MCK}}+113$

**Notes 1.** Transfer rate in the SNOOZE mode : MAX. 1 Mbps

- When DAPmn = 0 and CKPmn = 0, or DAPmn = 1 and CKPmn = 1. The Slp setup time or Slp hold time becomes "from SCKp $\downarrow$ " when DAPmn = 0 and CKPmn = 1, or DAPmn = 1 and CKPmn = 0.
- When DAPmn = 0 and CKPmn = 0, or DAPmn = 1 and CKPmn = 1. The delay time to SOp output becomes "from SCKp $\uparrow$ " when DAPmn = 0 and CKPmn = 1, or DAPmn = 1 and CKPmn = 0.
- C is the load capacitance of the SOp output lines.

**Caution** Select the normal input buffer for the Slp pin and SCKp pin and the normal output mode for the SOp pin by using port input mode register g (PIMg) and port output mode register g (POMg).

- Remarks 1.** p: CSI number (p = 00, 01, 10, 11, 20, 21), m: Unit number (m = 0, 1), n: Channel number (n = 0 to 3),  
 g: PIM number (g = 0, 1)
- 2.**  $f_{\text{MCK}}$ : Serial array unit operation clock frequency  
 (Operation clock to be set by the CKSmn bit of serial mode register mn (SMRmn). m: Unit number,  
 n: Channel number (mn = 00 to 03, 10, 11))

**CSI mode connection diagram (during communication at same potential)**

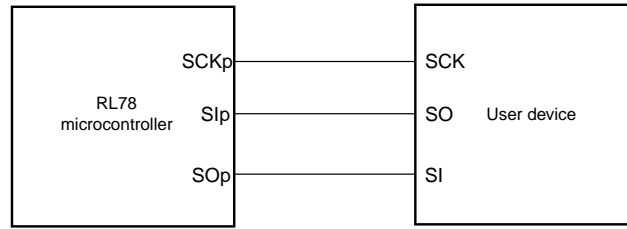

**CSI mode serial transfer timing (during communication at same potential)**  
 (When  $DAPmn = 0$  and  $CKPmn = 0$ , or  $DAPmn = 1$  and  $CKPmn = 1$ .)

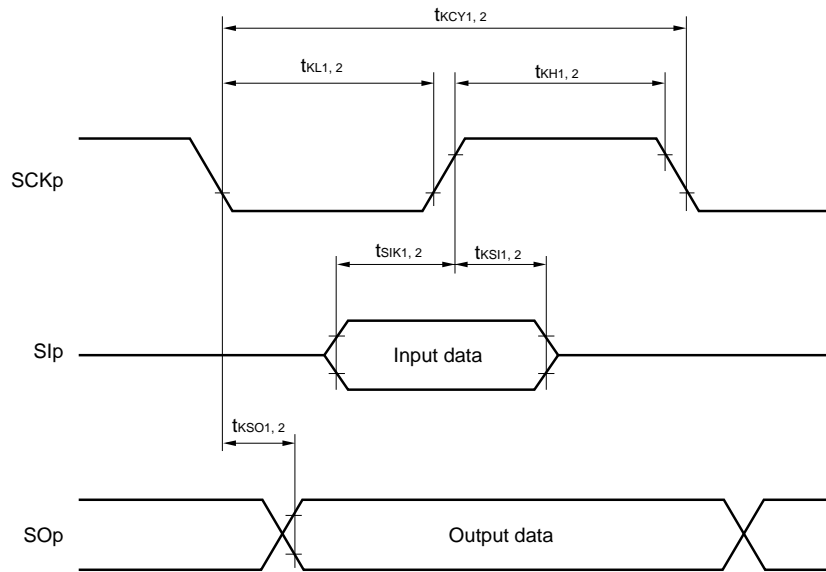

**CSI mode serial transfer timing (during communication at same potential)**  
 (When  $DAPmn = 0$  and  $CKPmn = 1$ , or  $DAPmn = 1$  and  $CKPmn = 0$ .)

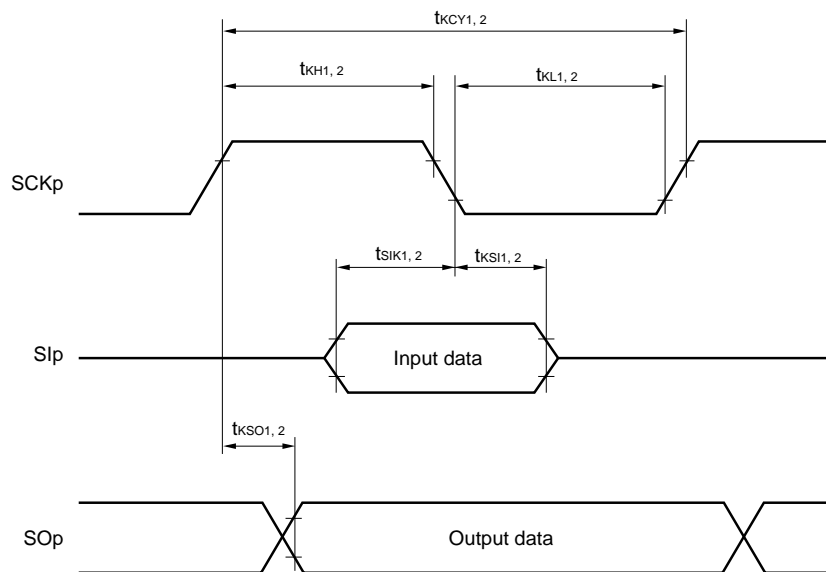

- Remarks**
1. p: CSI number (p = 00, 01, 10, 11, 20, 21)
  2. m: Unit number, n: Channel number (mn = 00 to 03, 10, 11)



**(4) During communication at same potential (simplified I<sup>2</sup>C mode)****( $T_A = -40$  to  $+105^\circ\text{C}$ ,  $2.4\text{ V} \leq EV_{DD0} \leq V_{DD} \leq 3.6\text{ V}$ ,  $V_{SS} = EV_{SS0} = 0\text{ V}$ )**

Parameter	Symbol	Conditions	MIN.	MAX.	Unit
SCLr clock frequency	f <sub>SCL</sub>	$2.7\text{ V} \leq EV_{DD0} \leq 3.6\text{ V}$ , $C_b = 50\text{ pF}$ , $R_b = 2.7\text{ k}\Omega$		400 <sup>Note 1</sup>	kHz
		$2.4\text{ V} \leq EV_{DD0} \leq 3.6\text{ V}$ , $C_b = 100\text{ pF}$ , $R_b = 3\text{ k}\Omega$		100 <sup>Note 1</sup>	kHz
Hold time when SCLr = "L"	t <sub>LOW</sub>	$2.7\text{ V} \leq EV_{DD0} \leq 3.6\text{ V}$ , $C_b = 50\text{ pF}$ , $R_b = 2.7\text{ k}\Omega$	1200		ns
		$2.4\text{ V} \leq EV_{DD0} \leq 3.6\text{ V}$ , $C_b = 100\text{ pF}$ , $R_b = 3\text{ k}\Omega$	4600		ns
Hold time when SCLr = "H"	t <sub>HIGH</sub>	$2.7\text{ V} \leq EV_{DD0} \leq 3.6\text{ V}$ , $C_b = 50\text{ pF}$ , $R_b = 2.7\text{ k}\Omega$	1200		ns
		$2.4\text{ V} \leq EV_{DD0} \leq 3.6\text{ V}$ , $C_b = 100\text{ pF}$ , $R_b = 3\text{ k}\Omega$	4600		ns
Data setup time (reception)	t <sub>SU:DAT</sub>	$2.7\text{ V} \leq EV_{DD0} \leq 3.6\text{ V}$ , $C_b = 50\text{ pF}$ , $R_b = 2.7\text{ k}\Omega$	$1/f_{MCK} +$ 220 <sup>Note 2</sup>		ns
		$2.4\text{ V} \leq EV_{DD0} \leq 3.6\text{ V}$ , $C_b = 100\text{ pF}$ , $R_b = 3\text{ k}\Omega$	$1/f_{MCK} +$ 580 <sup>Note 2</sup>		ns
Data hold time (transmission)	t <sub>HD:DAT</sub>	$2.7\text{ V} \leq EV_{DD0} \leq 3.6\text{ V}$ , $C_b = 50\text{ pF}$ , $R_b = 2.7\text{ k}\Omega$	0	770	ns
		$2.4\text{ V} \leq EV_{DD0} \leq 3.6\text{ V}$ , $C_b = 100\text{ pF}$ , $R_b = 3\text{ k}\Omega$	0	1420	ns

**Notes 1.** The value must also be  $f_{CLK}/4$  or lower.

**2.** Set the  $f_{MCK}$  value to keep the hold time of SCLr = "L" and SCLr = "H".

**Caution** Select the normal input buffer and the N-ch open drain output ( $V_{DD}$  tolerance (When 25- to 48-pin products)/ $EV_{DD}$  tolerance (When 64-pin products)) mode for the SDAr pin and the normal output mode for the SCLr pin by using port input mode register g (PIMg) and port output mode register h (POMh).

**Simplified I<sup>2</sup>C mode connection diagram (during communication at same potential)**

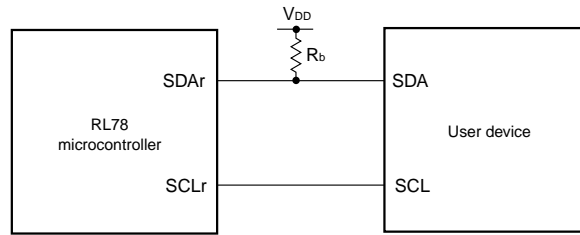

**Simplified I<sup>2</sup>C mode serial transfer timing (during communication at same potential)**

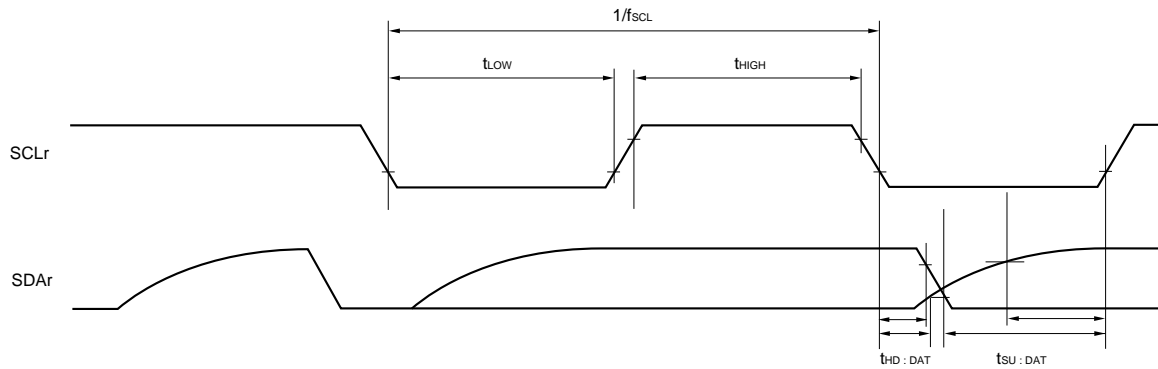

- Remarks**
1.  $R_b[\Omega]$ : Communication line (SDAr) pull-up resistance,  $C_b[F]$ : Communication line (SDAr, SCLr) load capacitance
  2. r: IIC number (r = 00, 01, 10, 11, 20, 21), g: PIM number (g = 0, 1), h: POM number (h = 0, 1)
  3.  $f_{MCK}$ : Serial array unit operation clock frequency  
(Operation clock to be set by the CKSmn bit of serial mode register mn (SMRmn). m: Unit number, n: Channel number, mn = 00 to 03, 10, 11)

**(5) Communication at different potential (1.8 V, 2.5 V) (UART mode) (dedicated baud rate generator output) (1/2)**  
**( $T_A = -40$  to  $+105^\circ\text{C}$ ,  $2.4\text{ V} \leq EV_{DD0} \leq V_{DD} \leq 3.6\text{ V}$ ,  $V_{SS} = EV_{SS0} = 0\text{ V}$ )**

Parameter	Symbol	Conditions		MIN.	TYP.	MAX.	Unit
Transfer rate <sup>Note 1</sup>		Reception	2.7 V $\leq$ EV <sub>DD0</sub> $\leq$ 3.6 V, 2.3 V $\leq$ V <sub>b</sub> $\leq$ 2.7 V			f <sub>MCK</sub> /12	bps
				Theoretical value of the maximum transfer rate f <sub>CLK</sub> = 32 MHz, f <sub>MCK</sub> = f <sub>CLK</sub>		2.6	Mbps
			2.4 V $\leq$ EV <sub>DD0</sub> $<$ 3.3 V, 1.6 V $\leq$ V <sub>b</sub> $\leq$ 2.0 V			f <sub>MCK</sub> /12	bps
				Theoretical value of the maximum transfer rate f <sub>CLK</sub> = 32 MHz, f <sub>MCK</sub> = f <sub>CLK</sub>		2.6 <sup>Note 2</sup>	Mbps

**Notes 1.** Transfer rate in the SNOOZE mode is 4800 bps.

**2.** The following conditions are required for low-voltage interface when  $EV_{DD0} < V_{DD}$ .

2.4 V  $\leq$  EV<sub>DD0</sub>  $<$  2.7 V : MAX. 1.3 Mbps

**Caution** Select the TTL input buffer for the Rx<sub>Dq</sub> pin and the N-ch open drain output ( $V_{DD}$  tolerance (When 25- to 48-pin products)/EV<sub>DD</sub> tolerance (When 64-pin products)) mode for the Tx<sub>Dq</sub> pin by using port input mode register g (PIMg) and port output mode register g (POMg). For V<sub>IH</sub> and V<sub>IL</sub>, see the DC characteristics with TTL input buffer selected.

<R>

**Remarks 1.** V<sub>b</sub>[V]: Communication line voltage

**2.** q: UART number (q = 0 to 2), g: PIM and POM number (g = 0, 1)

**3.** f<sub>MCK</sub>: Serial array unit operation clock frequency

(Operation clock to be set by the CKSmn bit of serial mode register mn (SMRmn). m: Unit number,

n: Channel number (mn = 00 to 03, 10, 11)

**(5) Communication at different potential (1.8 V, 2.5 V) (UART mode) (dedicated baud rate generator output) (2/2)**  
**( $T_A = -40$  to  $+105^\circ\text{C}$ ,  $2.4\text{ V} \leq EV_{DD0} \leq V_{DD} \leq 3.6\text{ V}$ ,  $V_{SS} = EV_{SS0} = 0\text{ V}$ )**

Parameter	Symbol	Conditions		MIN.	TYP.	MAX.	Unit
Transfer rate		Transmission	$2.7\text{ V} \leq EV_{DD0} \leq 3.6\text{ V}$ , $2.3\text{ V} \leq V_b \leq 2.7\text{ V}$			<b>Note 1</b>	bps
						1.2 <sup>Note 2</sup>	Mbps
			$2.4\text{ V} \leq EV_{DD0} < 3.3\text{ V}$ , $1.6\text{ V} \leq V_b \leq 2.0\text{ V}$			<b>Note 3</b>	bps
						0.43 <sup>Note 4</sup>	Mbps

**Notes 1.** The smaller maximum transfer rate derived by using  $f_{mck}/12$  or the following expression is the valid maximum transfer rate.

Expression for calculating the transfer rate when  $2.7\text{ V} \leq EV_{DD0} \leq 3.6\text{ V}$  and  $2.3\text{ V} \leq V_b \leq 2.7\text{ V}$

$$\text{Maximum transfer rate} = \frac{1}{\{-C_b \times R_b \times \ln(1 - \frac{2.0}{V_b})\} \times 3} \quad [\text{bps}]$$

$$\text{Baud rate error (theoretical value)} = \frac{\frac{1}{\text{Transfer rate} \times 2} - \{-C_b \times R_b \times \ln(1 - \frac{2.0}{V_b})\}}{(\frac{1}{\text{Transfer rate}}) \times \text{Number of transferred bits}} \times 100 \quad [\%]$$

\* This value is the theoretical value of the relative difference between the transmission and reception sides.

2. This value as an example is calculated when the conditions described in the "Conditions" column are met.

See **Note 1** above to calculate the maximum transfer rate under conditions of the customer.

3. The smaller maximum transfer rate derived by using  $f_{mck}/12$  or the following expression is the valid maximum transfer rate.

Expression for calculating the transfer rate when  $2.4\text{ V} \leq EV_{DD0} < 3.3\text{ V}$  and  $1.6\text{ V} \leq V_b \leq 2.0\text{ V}$

$$\text{Maximum transfer rate} = \frac{1}{\{-C_b \times R_b \times \ln(1 - \frac{1.5}{V_b})\} \times 3} \quad [\text{bps}]$$

$$\text{Baud rate error (theoretical value)} = \frac{\frac{1}{\text{Transfer rate} \times 2} - \{-C_b \times R_b \times \ln(1 - \frac{1.5}{V_b})\}}{(\frac{1}{\text{Transfer rate}}) \times \text{Number of transferred bits}} \times 100 \quad [\%]$$

\* This value is the theoretical value of the relative difference between the transmission and reception sides.

4. This value as an example is calculated when the conditions described in the "Conditions" column are met.

See **Note 3** above to calculate the maximum transfer rate under conditions of the customer.

**Caution** Select the TTL input buffer for the RxDq pin and the N-ch open drain output ( $V_{DD}$  tolerance (When 25- to 48-pin products)/ $EV_{DD}$  tolerance (When 64-pin products)) mode for the TxDq pin by using port input mode register g (PIMg) and port output mode register g (POMg). For  $V_{IH}$  and  $V_{IL}$ , see the DC characteristics with TTL input buffer selected.

<R>

**UART mode connection diagram (during communication at different potential)**

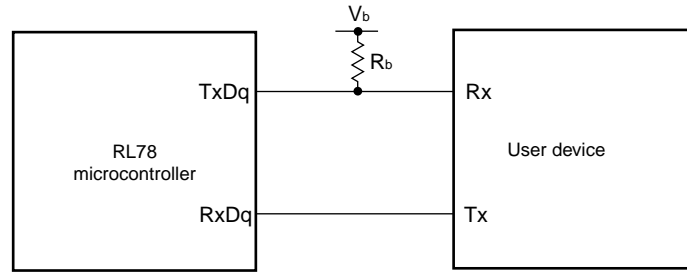

**UART mode bit width (during communication at different potential) (reference)**

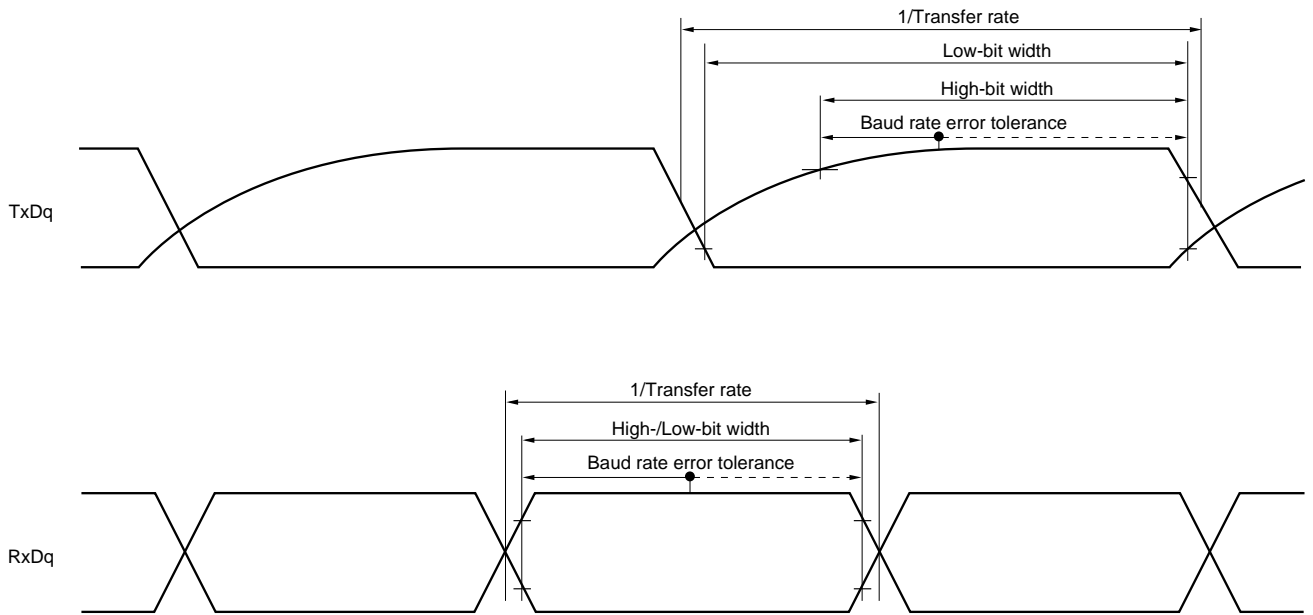

- Remarks**
1.  $R_b[\Omega]$ : Communication line (TxDq) pull-up resistance,  
 $C_b[F]$ : Communication line (TxDq) load capacitance,  $V_b[V]$ : Communication line voltage
  2. q: UART number (q = 0 to 2), g: PIM and POM number (g = 0, 1)
  3.  $f_{MCK}$ : Serial array unit operation clock frequency  
 (Operation clock to be set by the CKSmn bit of serial mode register mn (SMRmn).  
 m: Unit number, n: Channel number (mn = 00 to 03, 10, 11))

**(6) Communication at different potential (1.8 V, 2.5 V) (CSI mode) (master mode, SCKp... internal clock output) (1/2)**  
**( $T_A = -40$  to  $+105^\circ\text{C}$ ,  $2.4\text{ V} \leq EV_{DD0} \leq V_{DD} \leq 3.6\text{ V}$ ,  $V_{SS} = EV_{SS0} = 0\text{ V}$ )**

Parameter	Symbol	Conditions	MIN.	TYP.	MAX.	Unit
SCKp cycle time	$t_{KCY1}$	$2.7\text{ V} \leq EV_{DD0} \leq 3.6\text{ V}$ , $2.3\text{ V} \leq V_b \leq 2.7\text{ V}$ , $C_b = 30\text{ pF}$ , $R_b = 2.7\text{ k}\Omega$	$t_{KCY1} \geq 4/f_{CLK}$	1000		ns
		$2.4\text{ V} \leq EV_{DD0} < 3.3\text{ V}$ , $1.6\text{ V} \leq V_b \leq 2.0\text{ V}$ , $C_b = 30\text{ pF}$ , $R_b = 5.5\text{ k}\Omega$	$t_{KCY1} \geq 4/f_{CLK}$	2300		ns
SCKp high-level width	$t_{KH1}$	$2.7\text{ V} \leq EV_{DD0} \leq 3.6\text{ V}$ , $2.3\text{ V} \leq V_b \leq 2.7\text{ V}$ , $C_b = 30\text{ pF}$ , $R_b = 2.7\text{ k}\Omega$		$t_{KCY1}/2 - 340$		ns
		$2.4\text{ V} \leq EV_{DD0} < 3.3\text{ V}$ , $1.6\text{ V} \leq V_b \leq 2.0\text{ V}$ , $C_b = 30\text{ pF}$ , $R_b = 5.5\text{ k}\Omega$		$t_{KCY1}/2 - 916$		ns
SCKp low-level width	$t_{KL1}$	$2.7\text{ V} \leq EV_{DD0} \leq 3.6\text{ V}$ , $2.3\text{ V} \leq V_b \leq 2.7\text{ V}$ , $C_b = 30\text{ pF}$ , $R_b = 2.7\text{ k}\Omega$		$t_{KCY1}/2 - 36$		ns
		$2.4\text{ V} \leq EV_{DD0} < 3.3\text{ V}$ , $1.6\text{ V} \leq V_b \leq 2.0\text{ V}$ , $C_b = 30\text{ pF}$ , $R_b = 5.5\text{ k}\Omega$		$t_{KCY1}/2 - 100$		ns

&lt;R&gt;

**Caution** Select the TTL input buffer for the SIp pin and the N-ch open drain output ( $V_{DD}$  tolerance (When 25- to 48-pin products)/ $EV_{DD}$  tolerance (When 64-pin products)) mode for the SOp pin and SCKp pin by using port input mode register g (PIMg) and port output mode register g (POMg). For  $V_{IH}$  and  $V_{IL}$ , see the DC characteristics with TTL input buffer selected.

- Remarks**
- $R_b[\Omega]$ : Communication line (SCKp, SOp) pull-up resistance,  $C_b[\text{F}]$ : Communication line (SCKp, SOp) load capacitance,  $V_b[\text{V}]$ : Communication line voltage
  - p: CSI number (p = 00, 10, 20), m: Unit number, n: Channel number (mn = 00, 02, 10), g: PIM and POM number (g = 0, 1)
  - CSI01, CSI11, and CSI21 cannot communicate at different potential. Use other CSI for communication at different potential.

**(6) Communication at different potential (1.8 V, 2.5 V) (CSI mode) (master mode, SCKp... internal clock output) (2/2)**  
**(T<sub>A</sub> = -40 to +105°C, 2.4 V ≤ EV<sub>DD0</sub> ≤ V<sub>DD</sub> ≤ 3.6 V, V<sub>SS</sub> = EV<sub>SS0</sub> = 0 V)**

Parameter	Symbol	Conditions	MIN.	TYP.	MAX.	Unit
Slp setup time (to SCKp↑) <sup>Note 1</sup>	t <sub>SIK1</sub>	2.7 V ≤ EV <sub>DD0</sub> ≤ 3.6 V, 2.3 V ≤ V <sub>b</sub> ≤ 2.7 V, C <sub>b</sub> = 30 pF, R <sub>b</sub> = 2.7 kΩ	354			ns
		2.4 V ≤ EV <sub>DD0</sub> < 3.3 V, 1.6 V ≤ V <sub>b</sub> ≤ 2.0 V, C <sub>b</sub> = 30 pF, R <sub>b</sub> = 5.5 kΩ	958			ns
Slp hold time (from SCKp↑) <sup>Note 1</sup>	t <sub>KSH1</sub>	2.7 V ≤ EV <sub>DD0</sub> ≤ 3.6 V, 2.3 V ≤ V <sub>b</sub> ≤ 2.7 V, C <sub>b</sub> = 30 pF, R <sub>b</sub> = 2.7 kΩ	38			ns
		2.4 V ≤ EV <sub>DD0</sub> < 3.3 V, 1.6 V ≤ V <sub>b</sub> ≤ 2.0 V, C <sub>b</sub> = 30 pF, R <sub>b</sub> = 5.5 kΩ	38			ns
Delay time from SCKp↓ to SO <sub>p</sub> output <sup>Note 1</sup>	t <sub>KSO1</sub>	2.7 V ≤ EV <sub>DD0</sub> ≤ 3.6 V, 2.3 V ≤ V <sub>b</sub> ≤ 2.7 V, C <sub>b</sub> = 30 pF, R <sub>b</sub> = 2.7 kΩ			390	ns
		2.4 V ≤ EV <sub>DD0</sub> < 3.3 V, 1.6 V ≤ V <sub>b</sub> ≤ 2.0 V, C <sub>b</sub> = 30 pF, R <sub>b</sub> = 5.5 kΩ			966	ns
Slp setup time (to SCKp↓) <sup>Note 2</sup>	t <sub>SIK1</sub>	2.7 V ≤ EV <sub>DD0</sub> ≤ 3.6 V, 2.3 V ≤ V <sub>b</sub> ≤ 2.7 V, C <sub>b</sub> = 30 pF, R <sub>b</sub> = 2.7 kΩ	88			ns
		2.4 V ≤ EV <sub>DD0</sub> < 3.3 V, 1.6 V ≤ V <sub>b</sub> ≤ 2.0 V, C <sub>b</sub> = 30 pF, R <sub>b</sub> = 5.5 kΩ	220			ns
Slp hold time (from SCKp↓) <sup>Note 2</sup>	t <sub>KSH1</sub>	2.7 V ≤ EV <sub>DD0</sub> ≤ 3.6 V, 2.3 V ≤ V <sub>b</sub> ≤ 2.7 V, C <sub>b</sub> = 30 pF, R <sub>b</sub> = 2.7 kΩ	38			ns
		2.4 V ≤ EV <sub>DD0</sub> < 3.3 V, 1.6 V ≤ V <sub>b</sub> ≤ 2.0 V, C <sub>b</sub> = 30 pF, R <sub>b</sub> = 5.5 kΩ	38			ns
Delay time from SCKp↑ to SO <sub>p</sub> output <sup>Note 2</sup>	t <sub>KSO1</sub>	2.7 V ≤ EV <sub>DD0</sub> ≤ 3.6 V, 2.3 V ≤ V <sub>b</sub> ≤ 2.7 V, C <sub>b</sub> = 30 pF, R <sub>b</sub> = 2.7 kΩ			50	ns
		2.4 V ≤ EV <sub>DD0</sub> < 3.3 V, 1.6 V ≤ V <sub>b</sub> ≤ 2.0 V, C <sub>b</sub> = 30 pF, R <sub>b</sub> = 5.5 kΩ			50	ns

- Notes 1.** When DAP<sub>mn</sub> = 0 and CKP<sub>mn</sub> = 0, or DAP<sub>mn</sub> = 1 and CKP<sub>mn</sub> = 1.  
**2.** When DAP<sub>mn</sub> = 0 and CKP<sub>mn</sub> = 1, or DAP<sub>mn</sub> = 1 and CKP<sub>mn</sub> = 0.

**Caution** Select the TTL input buffer for the Slp pin and the N-ch open drain output (V<sub>DD</sub> tolerance (When 25- to 48-pin products)/EV<sub>DD</sub> tolerance (When 64-pin products)) mode for the SO<sub>p</sub> pin and SCKp pin by using port input mode register g (PIMg) and port output mode register g (POMg). For V<sub>IH</sub> and V<sub>IL</sub>, see the DC characteristics with TTL input buffer selected.

<R>

**CSI mode connection diagram (during communication at different potential)**

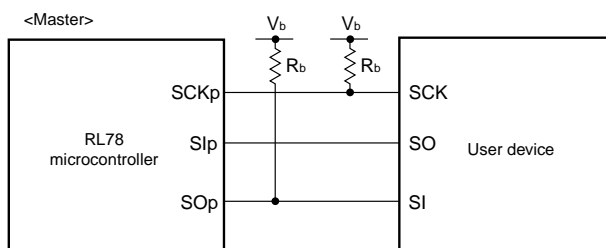

- Remarks 1.** R<sub>b</sub>[Ω]: Communication line (SCKp, SO<sub>p</sub>) pull-up resistance, C<sub>b</sub>[F]: Communication line (SCKp, SO<sub>p</sub>) load capacitance, V<sub>b</sub>[V]: Communication line voltage  
**2.** p: CSI number (p = 00, 10, 20), m: Unit number, n: Channel number (mn = 00, 02, 10), g: PIM and POM number (g = 0, 1)  
**3.** CSI01, CSI11, and CSI21 cannot communicate at different potential. Use other CSI for communication at different potential.

**CSI mode serial transfer timing (master mode) (during communication at different potential)  
(When DAPmn = 0 and CKPmn = 0, or DAPmn = 1 and CKPmn = 1.)**

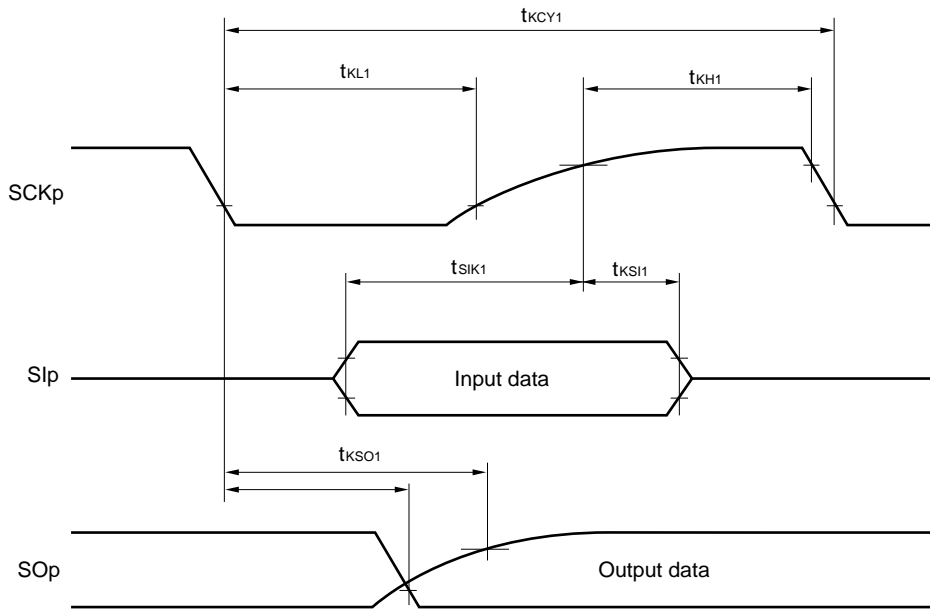

**CSI mode serial transfer timing (master mode) (during communication at different potential)  
(When DAPmn = 0 and CKPmn = 1, or DAPmn = 1 and CKPmn = 0.)**

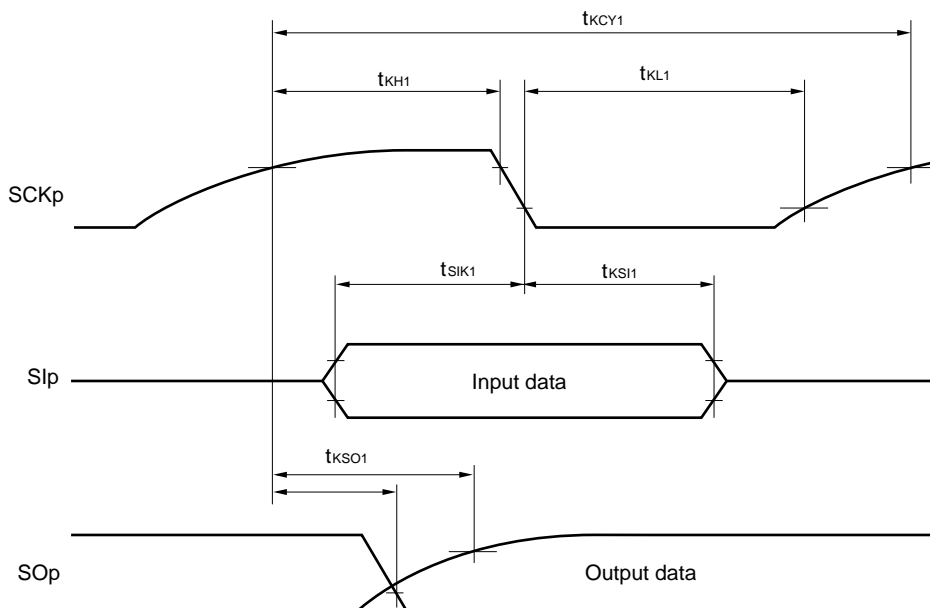

- Remarks**
1. p: CSI number (p = 00, 10, 20), m: Unit number, n: Channel number (m = 00, 02, 10), g: PIM and POM number (g = 0, 1)
  2. CSI01, CSI11, and CSI21 cannot communicate at different potential. Use other CSI for communication at different potential.



(7) Communication at different potential (1.8 V, 2.5 V) (CSI mode) (slave mode, SCKp... external clock input)  
 $(T_A = -40$  to  $+105^\circ\text{C}$ ,  $2.4\text{ V} \leq EV_{DD0} \leq V_{DD} \leq 3.6\text{ V}$ ,  $V_{SS} = EV_{SS0} = 0\text{ V}$ )

Parameter	Symbol	Conditions	MIN.	TYP.	MAX.	Unit
SCKp cycle time <sup>Note 1</sup>	$t_{KCY2}$	$2.7\text{ V} \leq EV_{DD0} \leq 3.6\text{ V}$ , $2.3\text{ V} \leq V_b \leq 2.7\text{ V}$	$24\text{ MHz} < f_{MCK}$	$40/f_{MCK}$		ns
			$20\text{ MHz} < f_{MCK} \leq 24\text{ MHz}$	$32/f_{MCK}$		ns
			$16\text{ MHz} < f_{MCK} \leq 20\text{ MHz}$	$28/f_{MCK}$		ns
			$8\text{ MHz} < f_{MCK} \leq 16\text{ MHz}$	$24/f_{MCK}$		ns
			$4\text{ MHz} < f_{MCK} \leq 8\text{ MHz}$	$16/f_{MCK}$		ns
			$f_{MCK} \leq 4\text{ MHz}$	$12/f_{MCK}$		ns
		$2.4\text{ V} \leq EV_{DD0} < 3.3\text{ V}$ , $1.6\text{ V} \leq V_b \leq 2.0\text{ V}$	$24\text{ MHz} < f_{MCK}$	$96/f_{MCK}$		ns
			$20\text{ MHz} < f_{MCK} \leq 24\text{ MHz}$	$72/f_{MCK}$		ns
			$16\text{ MHz} < f_{MCK} \leq 20\text{ MHz}$	$64/f_{MCK}$		ns
			$8\text{ MHz} < f_{MCK} \leq 16\text{ MHz}$	$52/f_{MCK}$		ns
			$4\text{ MHz} < f_{MCK} \leq 8\text{ MHz}$	$32/f_{MCK}$		ns
			$f_{MCK} \leq 4\text{ MHz}$	$20/f_{MCK}$		ns
SCKp high-/low-level width	$t_{KH2}$ , $t_{KL2}$	$2.7\text{ V} \leq EV_{DD0} \leq 3.6\text{ V}$ , $2.3\text{ V} \leq V_b \leq 2.7\text{ V}$	$t_{KCY2}/2 - 36$			ns
		$2.4\text{ V} \leq EV_{DD0} < 3.3\text{ V}$ , $1.6\text{ V} \leq V_b \leq 2.0\text{ V}$	$t_{KCY2}/2 - 100$			ns
Slp setup time (to SCKp $\uparrow$ ) <sup>Note 2</sup>	$t_{SIK2}$	$2.7\text{ V} \leq EV_{DD0} \leq 3.6\text{ V}$ , $2.3\text{ V} \leq V_b \leq 2.7\text{ V}$	$1/f_{MCK} + 40$			ns
		$2.4\text{ V} \leq EV_{DD0} < 3.3\text{ V}$ , $1.6\text{ V} \leq V_b \leq 2.0\text{ V}$	$1/f_{MCK} + 60$			ns
Slp hold time (from SCKp $\uparrow$ ) <sup>Note 2</sup>	$t_{KSI2}$		$1/f_{MCK} + 62$			ns
Delay time from SCKp $\downarrow$ to SOp output <sup>Note 3</sup>	$t_{KSO2}$	$2.7\text{ V} \leq EV_{DD0} \leq 3.6\text{ V}$ , $2.3\text{ V} \leq V_b \leq 2.7\text{ V}$ , $C_b = 30\text{ pF}$ , $R_b = 2.7\text{ k}\Omega$			$2/f_{MCK} + 428$	ns
		$2.4\text{ V} \leq EV_{DD0} < 3.3\text{ V}$ , $1.6\text{ V} \leq V_b \leq 2.0\text{ V}$ , $C_b = 30\text{ pF}$ , $R_b = 5.5\text{ k}\Omega$			$2/f_{MCK} + 1146$	ns

**Notes 1.** Transfer rate in the SNOOZE mode : MAX. 1 Mbps

**2.** When DAPmn = 0 and CKPmn = 0, or DAPmn = 1 and CKPmn = 1. The Slp setup time or Slp hold time becomes "from SCKp $\downarrow$ " when DAPmn = 0 and CKPmn = 1, or DAPmn = 1 and CKPmn = 0.

**3.** When DAPmn = 0 and CKPmn = 0, or DAPmn = 1 and CKPmn = 1. The delay time to SOp output becomes "from SCKp $\uparrow$ " when DAPmn = 0 and CKPmn = 1, or DAPmn = 1 and CKPmn = 0.

**Caution** Select the TTL input buffer for the Slp pin and SCKp pin and the N-ch open drain output ( $V_{DD}$  tolerance (When 25- to 48-pin products)/ $EV_{DD}$  tolerance (When 64-pin products)) mode for the SOp pin by using port input mode register g (PIMg) and port output mode register g (POMg). For  $V_{IH}$  and  $V_{IL}$ , see the DC characteristics with TTL input buffer selected.

<R>

(Remarks are listed on the next page.)

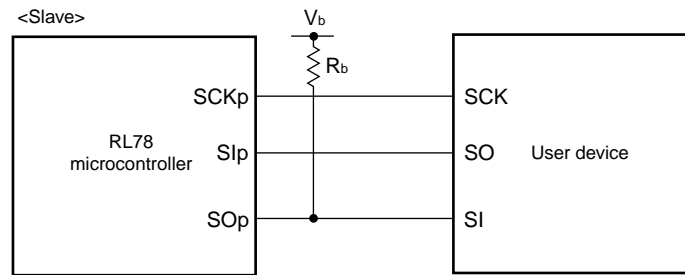
**CSI mode connection diagram (during communication at different potential)**

- Remarks**
1.  $R_b[\Omega]$ : Communication line (SO<sub>p</sub>) pull-up resistance,  $C_b[\text{F}]$ : Communication line (SO<sub>p</sub>) load capacitance,  $V_b[\text{V}]$ : Communication line voltage
  2. p: CSI number (p = 00, 10, 20), m: Unit number (m = 0, 1), n: Channel number (n = 00, 02, 10), g: PIM and POM number (g = 0, 1)
  3.  $f_{\text{mck}}$ : Serial array unit operation clock frequency  
(Operation clock to be set by the CKSmn bit of serial mode register mn (SMRmn).  
m: Unit number, n: Channel number (mn = 00, 02, 10))
  4. CSI01, CSI11, and CSI21 cannot communicate at different potential. Use other CSI for communication at different potential.

**CSI mode serial transfer timing (slave mode) (during communication at different potential)  
(When DAPmn = 0 and CKPmn = 0, or DAPmn = 1 and CKPmn = 1.)**

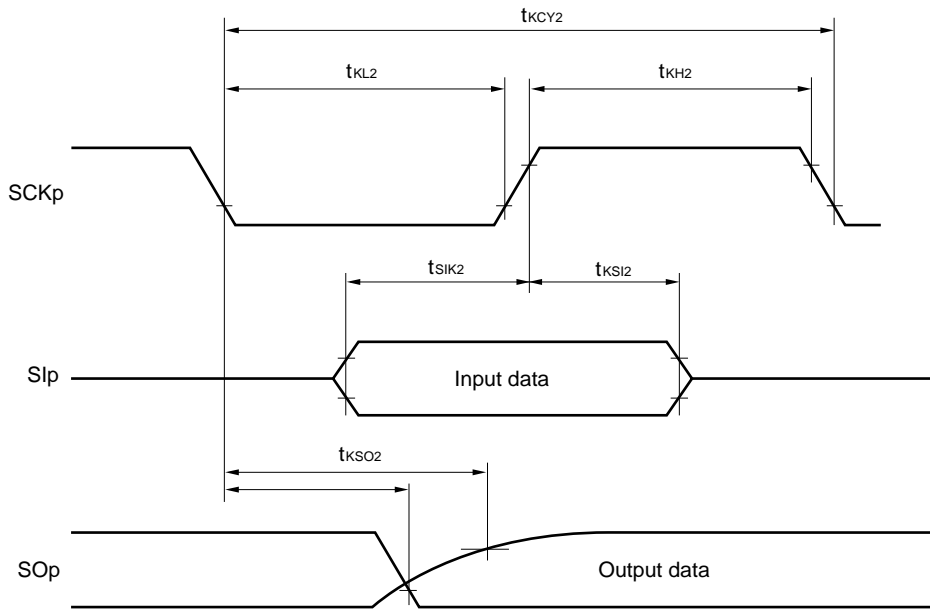

**CSI mode serial transfer timing (slave mode) (during communication at different potential)  
(When DAPmn = 0 and CKPmn = 1, or DAPmn = 1 and CKPmn = 0.)**

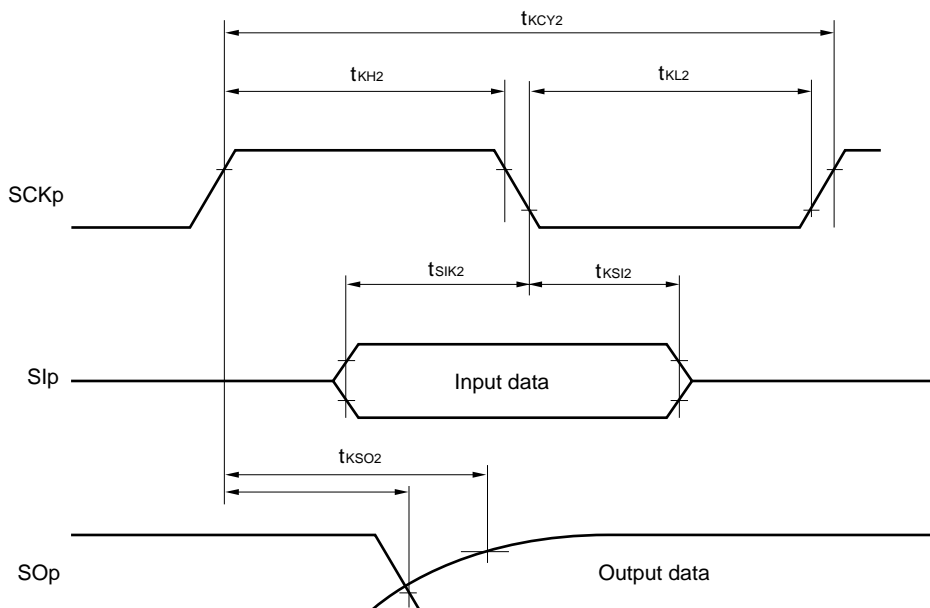

- Remarks 1.** p: CSI number (p = 00, 10, 20), m: Unit number, n: Channel number (mn = 00, 02, 10), g: PIM and POM number (g = 0, 1)
- 2.** CSI01, CSI11, and CSI21 cannot communicate at different potential. Use other CSI for communication at different potential.

**(8) Communication at different potential (1.8 V, 2.5 V) (simplified I<sup>2</sup>C mode) (1/2)****( $T_A = -40$  to  $+105^\circ\text{C}$ ,  $2.4\text{ V} \leq EV_{DD0} \leq V_{DD} \leq 3.6\text{ V}$ ,  $V_{SS} = EV_{SS0} = 0\text{ V}$ )**

Parameter	Symbol	Conditions	MIN.	MAX.	Unit
SCLr clock frequency	f <sub>SCL</sub>	2.7 V $\leq$ EV <sub>DD0</sub> $\leq$ 3.6 V, 2.3 V $\leq$ V <sub>b</sub> $\leq$ 2.7 V, C <sub>b</sub> = 50 pF, R <sub>b</sub> = 2.7 k $\Omega$		400 <sup>Note 1</sup>	kHz
		2.7 V $\leq$ EV <sub>DD0</sub> $\leq$ 3.6 V, 2.3 V $\leq$ V <sub>b</sub> $\leq$ 2.7 V, C <sub>b</sub> = 100 pF, R <sub>b</sub> = 2.7 k $\Omega$		100 <sup>Note 1</sup>	kHz
		2.4 V $\leq$ EV <sub>DD0</sub> < 3.3 V, 1.6 V $\leq$ V <sub>b</sub> $\leq$ 2.0 V, C <sub>b</sub> = 100 pF, R <sub>b</sub> = 5.5 k $\Omega$		100 <sup>Note 1</sup>	kHz
Hold time when SCLr = "L"	t <sub>LOW</sub>	2.7 V $\leq$ EV <sub>DD0</sub> $\leq$ 3.6 V, 2.3 V $\leq$ V <sub>b</sub> $\leq$ 2.7 V, C <sub>b</sub> = 50 pF, R <sub>b</sub> = 2.7 k $\Omega$	1200		ns
		2.7 V $\leq$ EV <sub>DD0</sub> $\leq$ 3.6 V, 2.3 V $\leq$ V <sub>b</sub> $\leq$ 2.7 V, C <sub>b</sub> = 100 pF, R <sub>b</sub> = 2.7 k $\Omega$	4600		ns
		2.4 V $\leq$ EV <sub>DD0</sub> < 3.3 V, 1.6 V $\leq$ V <sub>b</sub> $\leq$ 2.0 V, C <sub>b</sub> = 100 pF, R <sub>b</sub> = 5.5 k $\Omega$	4650		ns
Hold time when SCLr = "H"	t <sub>HIGH</sub>	2.7 V $\leq$ EV <sub>DD0</sub> $\leq$ 3.6 V, 2.3 V $\leq$ V <sub>b</sub> $\leq$ 2.7 V, C <sub>b</sub> = 50 pF, R <sub>b</sub> = 2.7 k $\Omega$	500		ns
		2.7 V $\leq$ EV <sub>DD0</sub> $\leq$ 3.6 V, 2.3 V $\leq$ V <sub>b</sub> $\leq$ 2.7 V, C <sub>b</sub> = 100 pF, R <sub>b</sub> = 2.7 k $\Omega$	2400		ns
		2.4 V $\leq$ EV <sub>DD0</sub> < 3.3 V, 1.6 V $\leq$ V <sub>b</sub> $\leq$ 2.0 V, C <sub>b</sub> = 100 pF, R <sub>b</sub> = 5.5 k $\Omega$	1830		ns

(Notes, Caution and Remarks are listed on the next page.)

**(8) Communication at different potential (1.8 V, 2.5 V) (simplified I<sup>2</sup>C mode) (2/2)****( $T_A = -40$  to  $+105^\circ\text{C}$ ,  $2.4\text{ V} \leq EV_{DD0} \leq V_{DD} \leq 3.6\text{ V}$ ,  $V_{SS} = EV_{SS0} = 0\text{ V}$ )**

Parameter	Symbol	Conditions	MIN.	MAX.	Unit
Data setup time (reception)	$t_{SU:DAT}$	$2.7\text{ V} \leq EV_{DD0} \leq 3.6\text{ V}$ , $2.3\text{ V} \leq V_b \leq 2.7\text{ V}$ , $C_b = 50\text{ pF}$ , $R_b = 2.7\text{ k}\Omega$	$1/f_{MCK} + 340$ <sup>Note 2</sup>		ns
		$2.7\text{ V} \leq EV_{DD0} \leq 3.6\text{ V}$ , $2.3\text{ V} \leq V_b \leq 2.7\text{ V}$ , $C_b = 100\text{ pF}$ , $R_b = 2.7\text{ k}\Omega$	$1/f_{MCK} + 760$ <sup>Note 2</sup>		ns
		$2.4\text{ V} \leq EV_{DD0} < 3.3\text{ V}$ , $1.6\text{ V} \leq V_b \leq 2.0\text{ V}$ , $C_b = 100\text{ pF}$ , $R_b = 5.5\text{ k}\Omega$	$1/f_{MCK} + 570$ <sup>Note 2</sup>		ns
Data hold time (transmission)	$t_{HD:DAT}$	$2.7\text{ V} \leq EV_{DD0} \leq 3.6\text{ V}$ , $2.3\text{ V} \leq V_b \leq 2.7\text{ V}$ , $C_b = 50\text{ pF}$ , $R_b = 2.7\text{ k}\Omega$	0	770	ns
		$2.7\text{ V} \leq EV_{DD0} \leq 3.6\text{ V}$ , $2.3\text{ V} \leq V_b \leq 2.7\text{ V}$ , $C_b = 100\text{ pF}$ , $R_b = 2.7\text{ k}\Omega$	0	1420	ns
		$2.4\text{ V} \leq EV_{DD0} < 3.3\text{ V}$ , $1.6\text{ V} \leq V_b \leq 2.0\text{ V}$ , $C_b = 100\text{ pF}$ , $R_b = 5.5\text{ k}\Omega$	0	1215	ns

**Notes 1.** The value must also be  $f_{CLK}/4$  or lower.

**2.** Set the  $f_{MCK}$  value to keep the hold time of  $SCLr = "L"$  and  $SCLr = "H"$ .

**Caution** Select the TTL input buffer and the N-ch open drain output ( $V_{DD}$  tolerance (When 25- to 48-pin products)/ $EV_{DD}$  tolerance (When 64-pin products)) mode for the  $SDAr$  pin and the N-ch open drain output ( $V_{DD}$  tolerance (When 25- to 48-pin products)/ $EV_{DD}$  tolerance (When 64-pin products)) mode for the  $SCLr$  pin by using port input mode register g (PIMg) and port output mode register g (POMg). For  $V_{IH}$  and  $V_{IL}$ , see the DC characteristics with TTL input buffer selected.

&lt;R&gt;

(Remarks are listed on the next page.)

**Simplified I<sup>2</sup>C mode connection diagram (during communication at different potential)**

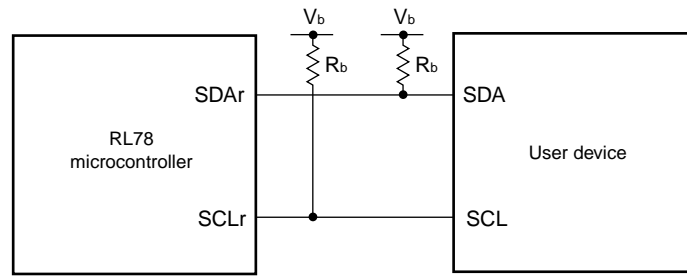

**Simplified I<sup>2</sup>C mode serial transfer timing (during communication at different potential)**

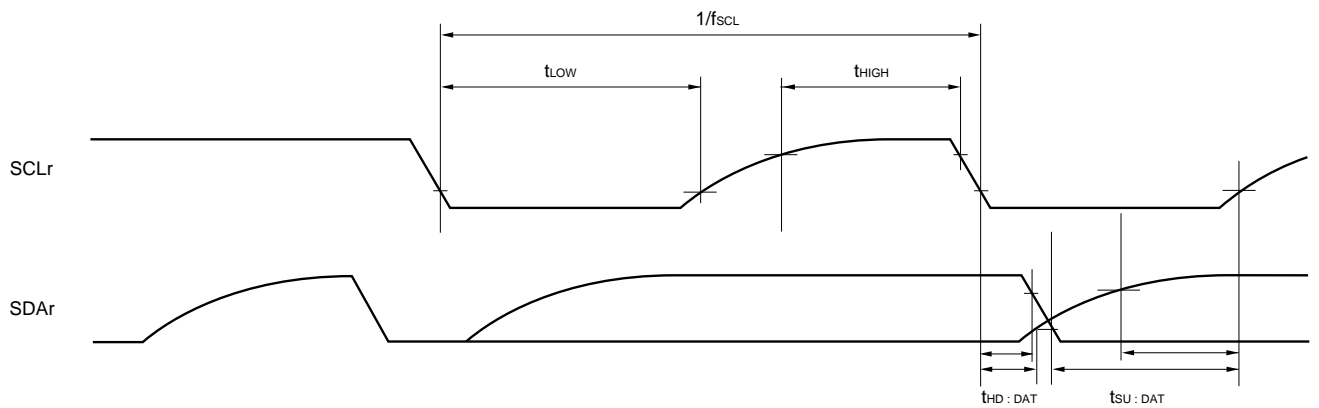

- Remarks**
1.  $R_b[\Omega]$ : Communication line (SDAr, SCLr) pull-up resistance,  $C_b[F]$ : Communication line (SDAr, SCLr) load capacitance,  $V_b[V]$ : Communication line voltage
  2. r: IIC number (r = 00, 10, 20), g: PIM, POM number (g = 0, 1)
  3.  $f_{mck}$ : Serial array unit operation clock frequency  
(Operation clock to be set by the CKSmn bit of serial mode register mn (SMRmn). m: Unit number, n: Channel number (mn = 00, 02, 10))
  4. IIC01, IIC11, and IIC21 cannot communicate at different potential. Use IIC00, IIC10, or IIC20 for communication at different potential.

### 3.5.2 Serial interface IICA

#### (1) I<sup>2</sup>C standard mode, fast mode

( $T_A = -40$  to  $+105^\circ\text{C}$ ,  $2.4\text{ V} \leq \text{EV}_{\text{DD0}} \leq \text{V}_{\text{DD}} \leq 3.6\text{ V}$ ,  $\text{V}_{\text{SS}} = \text{EV}_{\text{SS0}} = 0\text{ V}$ )

Parameter	Symbol	Conditions	Standard Mode		Fast Mode		Unit
			MIN.	MAX.	MIN.	MAX.	
SCLA0 clock frequency	$f_{\text{SCL}}$	Fast mode: $f_{\text{CLK}} \geq 3.5\text{ MHz}$			0	400	kHz
		Normal mode: $f_{\text{CLK}} \geq 1\text{ MHz}$	$2.4\text{ V} \leq \text{EV}_{\text{DD0}} \leq 3.6\text{ V}$	0	100		
Setup time of restart condition	$t_{\text{SU:STA}}$		4.7		0.6		$\mu\text{s}$
Hold time <sup>Note 1</sup>	$t_{\text{HD:STA}}$		4.0		0.6		$\mu\text{s}$
Hold time when SCLA0 = "L"	$t_{\text{LOW}}$		4.7		1.3		$\mu\text{s}$
Hold time when SCLA0 = "H"	$t_{\text{HIGH}}$		4.0		0.6		$\mu\text{s}$
Data setup time (reception)	$t_{\text{SU:DAT}}$		250		100		ns
Data hold time (transmission) <sup>Note 2</sup>	$t_{\text{HD:DAT}}$		0	3.45	0	0.9	$\mu\text{s}$
Setup time of stop condition	$t_{\text{SU:STO}}$		4.0		0.6		$\mu\text{s}$
Bus-free time	$t_{\text{BUF}}$		4.7		1.3		$\mu\text{s}$

- Notes**
- The first clock pulse is generated after this period when the start/restart condition is detected.
  - The maximum value (MAX.) of  $t_{\text{HD:DAT}}$  is during normal transfer and a wait state is inserted in the ACK (acknowledge) timing.

**Remark** The maximum value of  $C_b$  (communication line capacitance) and the value of  $R_b$  (communication line pull-up resistor) at that time in each mode are as follows.

Standard mode:  $C_b = 400\text{ pF}$ ,  $R_b = 2.7\text{ k}\Omega$

Fast mode:  $C_b = 320\text{ pF}$ ,  $R_b = 1.1\text{ k}\Omega$

IICA serial transfer timing

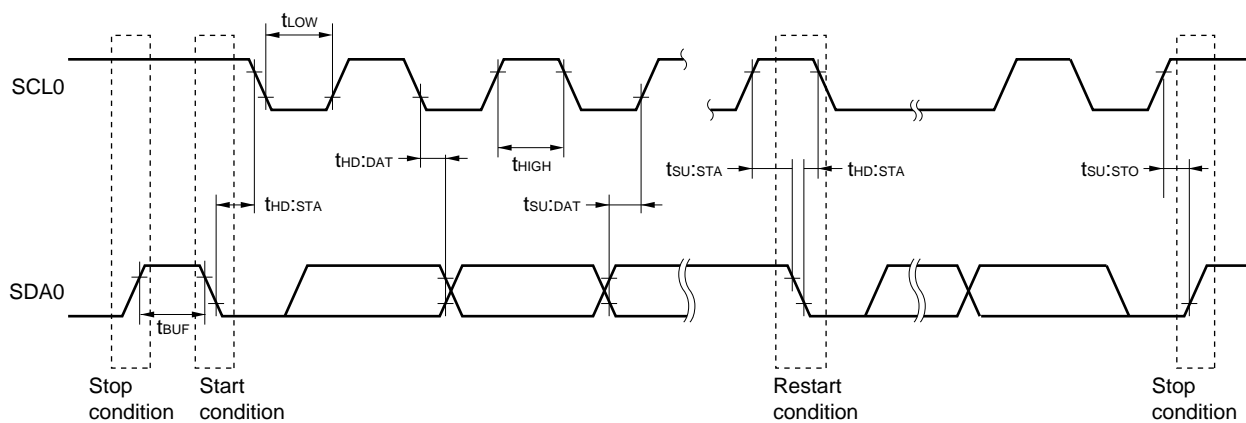

### 3.6 Analog Characteristics

#### 3.6.1 A/D converter characteristics

**Division of A/D Converter Characteristics**

Reference voltage Input channel	Reference voltage (+) = $AV_{REFP}$ Reference voltage (-) = $AV_{REFM}$	Reference voltage (+) = $AV_{DD}$ Reference voltage (-) = $AV_{SS}$	Reference voltage (+) = Internal reference voltage Reference voltage (-) = $AV_{SS}$
High-accuracy channel; ANI0 to ANI12 (input buffer power supply: $AV_{DD}$ )	See 3.6.1 (1)	See 3.6.1 (2)	See 3.6.1 (5)
Standard channel; ANI16 to ANI30 (input buffer power supply: $V_{DD}$ or $EV_{DD0}$ )	See 3.6.1 (3)	See 3.6.1 (4)	
Temperature sensor, internal reference voltage output	See 3.6.1 (3)	See 3.6.1 (4)	–

<R> (1) When reference voltage (+) =  $AV_{REFP}/ANI0$  ( $ADREFP1 = 0$ ,  $ADREFP0 = 1$ ), reference voltage (-) =  $AV_{REFM}/ANI1$  ( $ADREFM = 1$ ), target for conversion: ANI2 to ANI12

( $T_A = -40$  to  $+105^\circ\text{C}$ ,  $2.4\text{ V} \leq AV_{REFP} \leq AV_{DD} \leq V_{DD} \leq 3.6\text{ V}$ ,  $V_{SS} = 0\text{ V}$ ,  $AV_{SS} = 0\text{ V}$ , Reference voltage (+) =  $AV_{REFP}$ , Reference voltage (-) =  $AV_{REFM} = 0\text{ V}$ )

Parameter	Symbol	Conditions	MIN.	TYP.	MAX.	Unit
Resolution	$R_{ES}$	$2.4\text{ V} \leq AV_{REFP} \leq AV_{DD} \leq 3.6\text{ V}$	8.		12.	bit
Overall error <sup>Note</sup>	$A_{INL}$	12-bit resolution $2.4\text{ V} \leq AV_{REFP} \leq AV_{DD} \leq 3.6\text{ V}$			$\pm 6.0$	LSB
Conversion time	$t_{CONV}$	$ADTYP = 0$ , 12-bit resolution $2.4\text{ V} \leq AV_{REFP} \leq AV_{DD} \leq 3.6\text{ V}$	3.375			$\mu\text{s}$
Zero-scale error <sup>Note</sup>	$E_{ZS}$	12-bit resolution $2.4\text{ V} \leq AV_{REFP} \leq AV_{DD} \leq 3.6\text{ V}$			$\pm 4.5$	LSB
Full-scale error <sup>Note</sup>	$E_{FS}$	12-bit resolution $2.4\text{ V} \leq AV_{REFP} \leq AV_{DD} \leq 3.6\text{ V}$			$\pm 4.5$	LSB
Integral linearity error <sup>Note</sup>	$I_{LE}$	12-bit resolution $2.4\text{ V} \leq AV_{REFP} \leq AV_{DD} \leq 3.6\text{ V}$			$\pm 2.0$	LSB
Differential linearity error <sup>Note</sup>	$D_{LE}$	12-bit resolution $2.4\text{ V} \leq AV_{REFP} \leq AV_{DD} \leq 3.6\text{ V}$			$\pm 1.5$	LSB
Analog input voltage	$V_{AIN}$		0		$AV_{REFP}$	V

**Note** Excludes quantization error ( $\pm 1/2$  LSB).



<R> (2) When reference voltage (+) =  $AV_{DD}$  (ADREFP1 = 0, ADREFP0 = 0), reference voltage (-) =  $AV_{SS}$  (ADREFM = 0), target for conversion: ANI0 to ANI12

( $T_A = -40$  to  $+105^\circ\text{C}$ ,  $2.4\text{ V} \leq AV_{DD} \leq V_{DD} \leq 3.6\text{ V}$ ,  $V_{SS} = 0\text{ V}$ ,  $AV_{SS} = 0\text{ V}$ , Reference voltage (+) =  $AV_{DD}$ , Reference voltage (-) =  $AV_{SS} = 0\text{ V}$ )

Parameter	Symbol	Conditions		MIN.	TYP.	MAX.	Unit
Resolution	$R_{ES}$		$2.4\text{ V} \leq AV_{DD} \leq 3.6\text{ V}$	8		12	bit
Overall error <sup>Note</sup>	$A_{INL}$	12-bit resolution	$2.4\text{ V} \leq AV_{DD} \leq 3.6\text{ V}$			$\pm 7.5$	LSB
Conversion time	$t_{CONV}$	ADTYP = 0, 12-bit resolution	$2.4\text{ V} \leq AV_{DD} \leq 3.6\text{ V}$	3.375			$\mu\text{s}$
Zero-scale error <sup>Note</sup>	$E_{ZS}$	12-bit resolution	$2.4\text{ V} \leq AV_{DD} \leq 3.6\text{ V}$			$\pm 6.0$	LSB
Full-scale error <sup>Note</sup>	$E_{FS}$	12-bit resolution	$2.4\text{ V} \leq AV_{DD} \leq 3.6\text{ V}$			$\pm 6.0$	LSB
Integral linearity error <sup>Note</sup>	$I_{LE}$	12-bit resolution	$2.4\text{ V} \leq AV_{DD} \leq 3.6\text{ V}$			$\pm 3.0$	LSB
Differential linearity error <sup>Note</sup>	$D_{LE}$	12-bit resolution	$2.4\text{ V} \leq AV_{DD} \leq 3.6\text{ V}$			$\pm 2.0$	LSB
Analog input voltage	$V_{AIN}$			0		$AV_{DD}$	V

**Note** Excludes quantization error ( $\pm 1/2$  LSB).

<R> (3) When reference voltage (+) =  $AV_{REFP}/ANI0$  ( $ADREFP1 = 0$ ,  $ADREFP0 = 1$ ), reference voltage (-) =  $AV_{REFM}/ANI1$  ( $ADREFM = 1$ ), target for conversion: ANI16 to ANI30, internal reference voltage, temperature sensor output voltage

( $T_A = -40$  to  $+105^\circ\text{C}$ ,  $2.4\text{ V} \leq EV_{DD0} \leq V_{DD} \leq 3.6\text{ V}$ ,  $2.4\text{ V} \leq AV_{REFP} \leq AV_{DD} \leq V_{DD} \leq 3.6\text{ V}$ ,  $V_{SS} = EV_{SS0} = 0\text{ V}$ ,  $AV_{SS} = 0\text{ V}$ , Reference voltage (+) =  $AV_{REFP}$ , Reference voltage (-) =  $AV_{REFM} = 0\text{ V}$ )

Parameter	Symbol	Conditions		MIN.	TYP.	MAX.	Unit
Resolution	$R_{ES}$		$2.4\text{ V} \leq AV_{REFP} \leq AV_{DD} \leq 3.6\text{ V}$	8		12	bit
Overall error <sup>Note 1</sup>	$A_{INL}$	12-bit resolution	$2.4\text{ V} \leq AV_{REFP} \leq AV_{DD} \leq 3.6\text{ V}$			$\pm 7.0$	LSB
Conversion time	$t_{CONV}$	$ADTYP = 0$ , 12-bit resolution	$2.4\text{ V} \leq AV_{REFP} \leq AV_{DD} \leq 3.6\text{ V}$	4.125			$\mu\text{s}$
Zero-scale error <sup>Note 1</sup>	$E_{ZS}$	12-bit resolution	$2.4\text{ V} \leq AV_{REFP} \leq AV_{DD} \leq 3.6\text{ V}$			$\pm 5.0$	LSB
Full-scale error <sup>Note 1</sup>	$E_{FS}$	12-bit resolution	$2.4\text{ V} \leq AV_{REFP} \leq AV_{DD} \leq 3.6\text{ V}$			$\pm 5.0$	LSB
Integral linearity error <sup>Note 1</sup>	$I_{LE}$	12-bit resolution	$2.4\text{ V} \leq AV_{REFP} \leq AV_{DD} \leq 3.6\text{ V}$			$\pm 3.0$	LSB
Differential linearity error <sup>Note 1</sup>	$D_{LE}$	12-bit resolution	$2.4\text{ V} \leq AV_{REFP} \leq AV_{DD} \leq 3.6\text{ V}$			$\pm 2.0$	LSB
Analog input voltage	$V_{AIN}$			0.		$AV_{REFP}$ and $EV_{DD0}$	V
		Internal reference voltage ( $2.4\text{ V} \leq V_{DD} \leq 3.6\text{ V}$ , HS (high-speed main) mode)			$V_{BGR}$ <sup>Note 2</sup>		V
		Temperature sensor output voltage ( $2.4\text{ V} \leq V_{DD} \leq 3.6\text{ V}$ , HS (high-speed main) mode)			$V_{TMPS25}$ <sup>Note 2</sup>		V

**Notes 1.** Excludes quantization error ( $\pm 1/2$  LSB).

**2.** See 3.6.2 Temperature sensor, internal reference voltage output characteristics.

<R> (4) When reference voltage (+) =  $AV_{DD}$  (ADREFP1 = 0, ADREFP0 = 0), reference voltage (-) =  $AV_{SS}$  (ADREFM = 0), target for conversion: ANI16 to ANI30, internal reference voltage, temperature sensor output voltage

( $T_A = -40$  to  $+105^\circ\text{C}$ ,  $2.4\text{ V} \leq EV_{DD0} \leq V_{DD0} \leq 3.6\text{ V}$ ,  $2.4\text{ V} \leq AV_{DD} \leq V_{DD} \leq 3.6\text{ V}$ ,  $V_{SS} = EV_{SS0} = 0\text{ V}$ ,  $AV_{SS} = 0\text{ V}$ , Reference voltage (+) =  $AV_{DD}$ , Reference voltage (-) =  $AV_{SS} = 0\text{ V}$ )

Parameter	Symbol	Conditions		MIN.	TYP.	MAX.	Unit
Resolution	$R_{ES}$		$2.4\text{ V} \leq AV_{DD} \leq 3.6\text{ V}$	8		12	bit
Overall error <sup>Note 1</sup>	$A_{INL}$	12-bit resolution	$2.4\text{ V} \leq AV_{DD} \leq 3.6\text{ V}$			$\pm 8.5$	LSB
Conversion time	$t_{CONV}$	ADTYP = 0, 12-bit resolution	$2.4\text{ V} \leq AV_{DD} \leq 3.6\text{ V}$	4.125			$\mu\text{s}$
Zero-scale error <sup>Note 1</sup>	$E_{ZS}$	12-bit resolution	$2.4\text{ V} \leq AV_{DD} \leq 3.6\text{ V}$			$\pm 8.0$	LSB
Full-scale error <sup>Note 1</sup>	$E_{FS}$	12-bit resolution	$2.4\text{ V} \leq AV_{DD} \leq 3.6\text{ V}$			$\pm 8.0$	LSB
Integral linearity error <sup>Note 1</sup>	$I_{LE}$	12-bit resolution	$2.4\text{ V} \leq AV_{DD} \leq 3.6\text{ V}$			$\pm 3.5$	LSB
Differential linearity error <sup>Note 1</sup>	$D_{LE}$	12-bit resolution	$2.4\text{ V} \leq AV_{DD} \leq 3.6\text{ V}$			$\pm 2.5$	LSB
Analog input voltage	$V_{AIN}$			0		$AV_{DD}$ and $EV_{DD0}$	V
		Internal reference voltage ( $2.4\text{ V} \leq V_{DD} \leq 3.6\text{ V}$ , HS (high-speed main) mode)		$V_{BGR}$ <sup>Note 2</sup>			V
		Temperature sensor output voltage ( $2.4\text{ V} \leq V_{DD} \leq 3.6\text{ V}$ , HS (high-speed main) mode)		$V_{TMPS25}$ <sup>Note 2</sup>			V

**Notes 1.** Excludes quantization error ( $\pm 1/2$  LSB).

**2.** See 3.6.2 Temperature sensor, internal reference voltage output characteristics.

<R> (5) When reference voltage (+) = Internal reference voltage (1.45 V) (ADREFP1 = 1, ADREFP0 = 0), reference voltage (-) =  $AV_{SS}$  (ADREFM = 0), target for conversion: ANI0 to ANI12, ANI16 to ANI30

( $T_A = -40$  to  $+105^\circ\text{C}$ ,  $2.4\text{ V} \leq V_{DD} \leq 3.6\text{ V}$ ,  $2.4\text{ V} \leq EV_{DD} \leq V_{DD}$ ,  $2.4\text{ V} \leq AV_{DD} \leq V_{DD}$ ,  $V_{SS} = EV_{SS0} = 0\text{ V}$ ,  $AV_{SS} = 0\text{ V}$ , Reference voltage (+) = Internal reference voltage, Reference voltage (-) =  $AV_{SS} = 0\text{ V}$ , HS (high-speed main) mode)

Parameter	Symbol	Conditions	MIN.	TYP.	MAX.	Unit
Resolution	$R_{ES}$		8			bit
Conversion time	$t_{CONV}$	8-bit resolution	16.0			$\mu\text{s}$
Zero-scale error <sup>Note</sup>	$E_{ZS}$	8-bit resolution			$\pm 4.0$	LSB
Integral linearity error <sup>Note</sup>	$I_{LE}$	8-bit resolution			$\pm 2.0$	LSB
Differential linearity error <sup>Note</sup>	$D_{LE}$	8-bit resolution			$\pm 2.5$	LSB
Reference voltage (+)	$AV_{REF(+)}$	= Internal reference voltage ( $V_{BGR}$ )	1.38	1.45	1.50	V
Analog input voltage	$V_{AIN}$		0		$V_{BGR}$	V

**Note** Excludes quantization error ( $\pm 1/2$  LSB).

### 3.6.2 Temperature sensor, internal reference voltage output characteristics

( $T_A = -40$  to  $+105^\circ\text{C}$ ,  $2.4\text{ V} \leq V_{DD} \leq 3.6\text{ V}$ ,  $V_{SS} = 0\text{ V}$ , HS (high-speed main) mode)

Parameter	Symbol	Conditions	MIN.	TYP.	MAX.	Unit
Temperature sensor output voltage	$V_{TMPS25}$	Setting ADS register = 80H, $T_A = +25^\circ\text{C}$		1.05		V
Internal reference voltage	$V_{BGR}$	Setting ADS register = 81H	1.38	1.45	1.5	V
Temperature coefficient	$F_{VTMPS}$	Temperature sensor output voltage that depends on the temperature		-3.6		$\text{mV}/^\circ\text{C}$
Operation stabilization wait time	$t_{AMP}$		10			$\mu\text{s}$

### 3.6.3 POR circuit characteristics

( $T_A = -40$  to  $+105^\circ\text{C}$ ,  $V_{SS} = 0\text{ V}$ )

Parameter	Symbol	Conditions	MIN.	TYP.	MAX.	Unit
Detection voltage	$V_{POR}$	Power supply rise time	1.45	1.51	1.57	V
	$V_{PDR}$	Power supply fall time	1.44	1.50	1.56	V
Minimum pulse width <sup>Note</sup>	$T_{PW}$		300			$\mu\text{s}$

**Note** This is the time required for the POR circuit to execute a reset when  $V_{DD}$  falls below  $V_{PDR}$ . When the microcontroller enters STOP mode or if the main system clock ( $f_{MAIN}$ ) has been stopped by setting bit 0 (HIOSTOP) and bit 7 (MSTOP) of the clock operation status control register (CSC), this is the time required for the POR circuit to execute a reset before  $V_{DD}$  rises to  $V_{POR}$  after having fallen below 0.7 V.

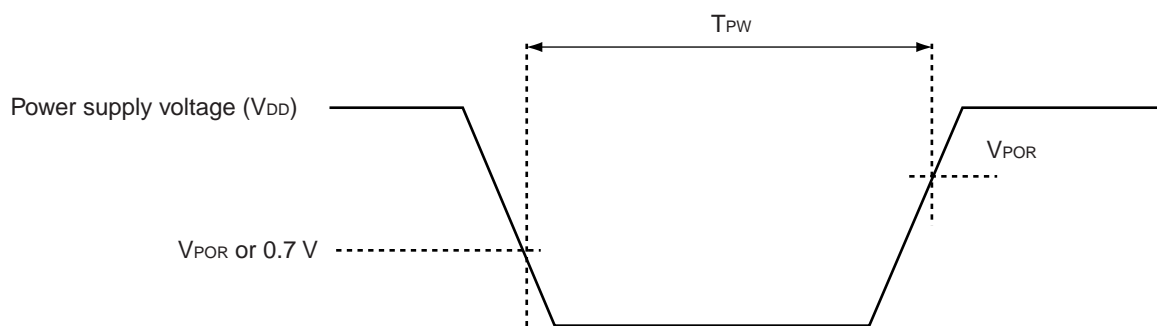

## 3.6.4 LVD circuit characteristics

**LVD Detection Voltage of Reset Mode and Interrupt Mode****( $T_A = -40$  to  $+105^\circ\text{C}$ ,  $V_{PDR} \leq V_{DD} \leq 3.6$  V,  $V_{SS} = 0$  V)**

Parameter	Symbol	Conditions	MIN.	TYP.	MAX.	Unit	
Detection voltage	$V_{LVD2}$	Power supply rise time	3.01	3.13	3.25	V	
		Power supply fall time	2.94	3.06	3.18	V	
	$V_{LVD3}$	Power supply rise time	2.90	3.02	3.14	V	
		Power supply fall time	2.85	2.96	3.07	V	
	$V_{LVD4}$	Power supply rise time	2.81	2.92	3.03	V	
		Power supply fall time	2.75	2.86	2.97	V	
	$V_{LVD5}$	Power supply rise time	2.70	2.81	2.92	V	
		Power supply fall time	2.64	2.75	2.86	V	
	$V_{LVD6}$	Power supply rise time	2.61	2.71	2.81	V	
		Power supply fall time	2.55	2.65	2.75	V	
	$V_{LVD7}$	Power supply rise time	2.51	2.61	2.71	V	
		Power supply fall time	2.45	2.55	2.65	V	
	Minimum pulse width	$t_{LW}$		300			$\mu\text{s}$
	Detection delay time					300	$\mu\text{s}$

**Remark**  $V_{LVD(n-1)} > V_{LVDn}$ :  $n = 3$  to  $7$ **LVD Detection Voltage of Interrupt & Reset Mode****( $T_A = -40$  to  $+105^\circ\text{C}$ ,  $V_{PDR} \leq V_{DD} \leq 3.6$  V,  $V_{SS} = 0$  V)**

Parameter	Symbol	Conditions	MIN.	TYP.	MAX.	Unit	
Interrupt & reset mode	$V_{LVD5}$	VPOC2, VPOC1, VPOC0 = 0, 1, 1, falling reset voltage	2.64	2.75	2.86	V	
	$V_{LVD4}$	LVIS1, LVIS0 = 1, 0	Rising release reset voltage	2.81	2.92	3.03	V
			Falling interrupt voltage	2.75	2.86	2.97	V
	$V_{LVD3}$	LVIS1, LVIS0 = 0, 1	Rising release reset voltage	2.90	3.02	3.14	V
			Falling interrupt voltage	2.85	2.96	3.07	V

**Caution** Set the detection voltage ( $V_{LVD}$ ) to be within the operating voltage range. The operating voltage range depends on the setting of the user option byte (000C2H/010C2H). The following shows the operating voltage range.

**HS (high-speed main) mode:**  $V_{DD} = 2.7$  to  $3.6$  V@1 MHz to 32 MHz

$V_{DD} = 2.4$  to  $3.6$  V@1 MHz to 16 MHz

## 3.6.5 Supply voltage rise slope characteristics

**( $T_A = -40$  to  $+105^\circ\text{C}$ ,  $V_{SS} = 0$  V)**

Parameter	Symbol	Conditions	MIN.	TYP.	MAX.	Unit
Supply voltage rise	$SV_{DD}$				54	V/ms

**Caution** Be sure to maintain the internal reset state until  $V_{DD}$  reaches the operating voltage range specified in 3.4 AC Characteristics, by using the LVD circuit or external reset pin.

<R> 3.7 RAM Data Retention Characteristics

<R> ( $T_A = -40$  to  $+105^\circ\text{C}$ ,  $V_{SS} = 0$  V)

Parameter	Symbol	Conditions	MIN.	TYP.	MAX.	Unit
Data retention supply voltage	$V_{DDDR}$		1.44 <sup>Note</sup>		3.6	V

<R> **Note** This depends on the POR detection voltage. For a falling voltage, data in RAM are retained until the voltage reaches the level that triggers a POR reset but not once it reaches the level at which a POR reset is generated.

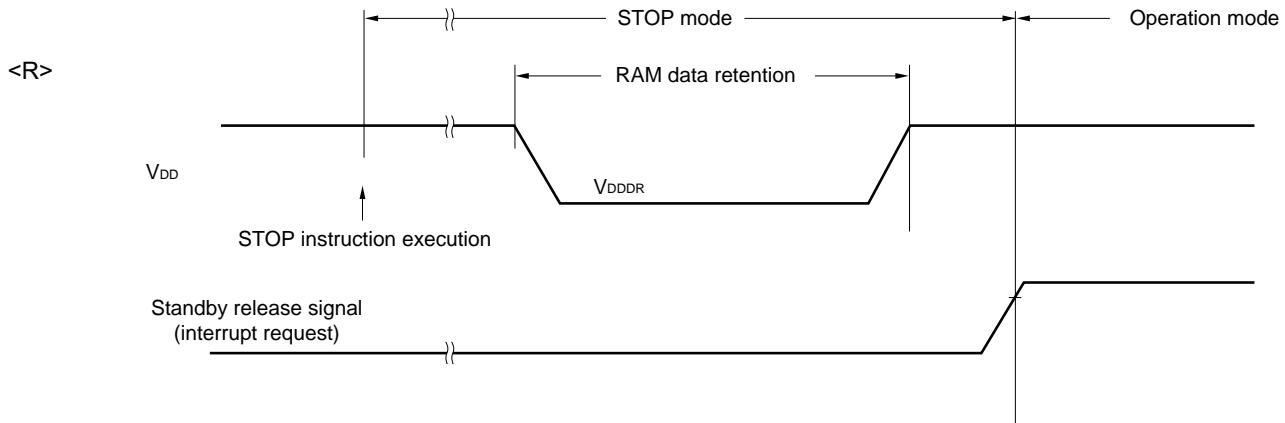

3.8 Flash Memory Programming Characteristics

( $T_A = -40$  to  $+105^\circ\text{C}$ ,  $2.4$  V  $\leq V_{DD} \leq 3.6$  V,  $V_{SS} = 0$  V)

Parameter	Symbol	Conditions	MIN.	TYP.	MAX.	Unit
CPU/peripheral hardware clock frequency	$f_{CLK}$	$2.4$ V $\leq V_{DD} \leq 3.6$ V	1		32	MHz
Number of code flash rewrites <sup>Notes 1, 2, 3</sup>	$C_{erwr}$	Retained for 20 years $T_A = 85^\circ\text{C}$	1,000			Times
Number of data flash rewrites <sup>Notes 1, 2, 3</sup>		Retained for 1 years $T_A = 25^\circ\text{C}$		1,000,000		
		Retained for 5 years $T_A = 85^\circ\text{C}$	100,000			
		Retained for 20 years $T_A = 85^\circ\text{C}$	10,000			

- Notes**
- 1 erase + 1 write after the erase is regarded as 1 rewrite. The retaining years are until next rewrite after the rewrite.
  2. When using flash memory programmer and Renesas Electronics self programming library
  3. These are the characteristics of the flash memory and the results obtained from reliability testing by Renesas Electronics Corporation.
  4. This temperature is the average value at which data are retained.

<R>

### 3.9 Dedicated Flash Memory Programmer Communication (UART)

( $T_A = -40$  to  $+105^\circ\text{C}$ ,  $2.4\text{ V} \leq EV_{DD0} \leq V_{DD} \leq 3.6\text{ V}$ ,  $V_{SS} = EV_{SS0} = 0\text{ V}$ )

Parameter	Symbol	Conditions	MIN.	TYP.	MAX.	Unit
Transfer rate		During flash memory programming	115.2 k		1 M	bps

### 3.10 Timing Specs for Switching Flash Memory Programming Modes

( $T_A = -40$  to  $+105^\circ\text{C}$ ,  $2.4\text{ V} \leq EV_{DD0} \leq V_{DD} \leq 3.6\text{ V}$ ,  $V_{SS} = EV_{SS0} = 0\text{ V}$ )

Parameter	Symbol	Conditions	MIN.	TYP.	MAX.	Unit
How long from when an external reset ends until the initial communication settings are specified	$t_{SUIINIT}$	POR and LVD reset must end before the external reset ends.			100	ms
How long from when the TOOL0 pin is placed at the low level until a external reset ends	$t_{SU}$	POR and LVD reset must end before the external reset ends.	10			$\mu\text{s}$
<R> How long the TOOL0 pin must be kept at the low level after an external reset ends (except flash firmware processing time)	$t_{HD}$	POR and LVD reset must end before the external reset ends.	1			ms

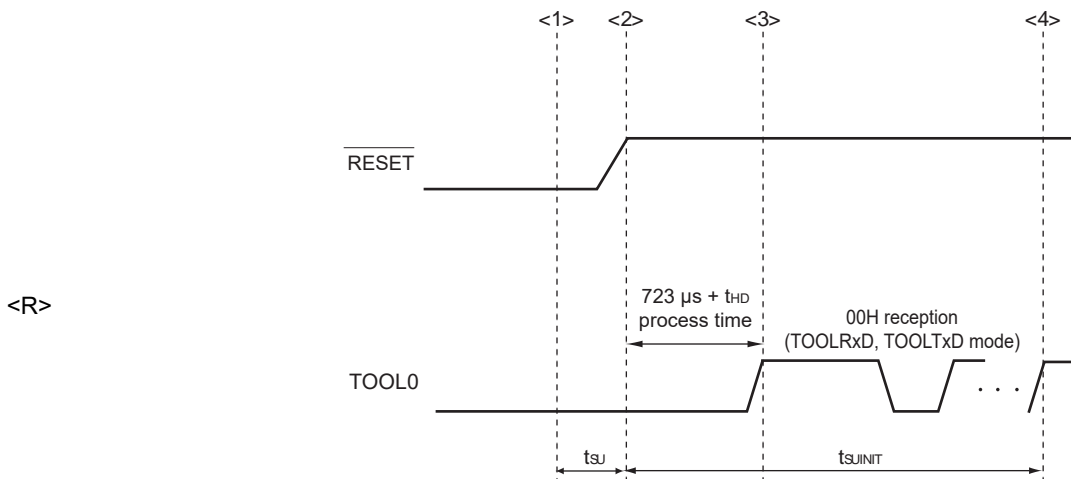

- <1> The low level is input to the TOOL0 pin.
- <2> The pins reset ends (POR and LVD reset must end before the external reset ends.).
- <3> The TOOL0 pin is set to the high level.
- <4> Setting of the flash memory programming mode by UART reception and complete the baud rate setting.

**Remark**  $t_{SUIINIT}$ : The segment shows that it is necessary to finish specifying the initial communication settings within 100 ms from when the resets end.

$t_{SU}$ : How long from when the TOOL0 pin is placed at the low level until a external reset ends

<R>  $t_{HD}$ : How long to keep the TOOL0 pin at the low level from when the external resets end (except flash firmware processing time)

### 4. PACKAGE DRAWINGS

#### 4.1 25-pin products

R5F10E8AALA, R5F10E8CALA, R5F10E8DALA, R5F10E8EALA

<R>	<b>JEITA Package Code</b>	<b>RENESAS Code</b>	<b>Previous Code</b>	<b>MASS (Typ) [g]</b>
	P-WFLGA25-3x3-0.50	PWLG0025KA-A	P25FC-50-2N2-3	0.01

Unit: mm

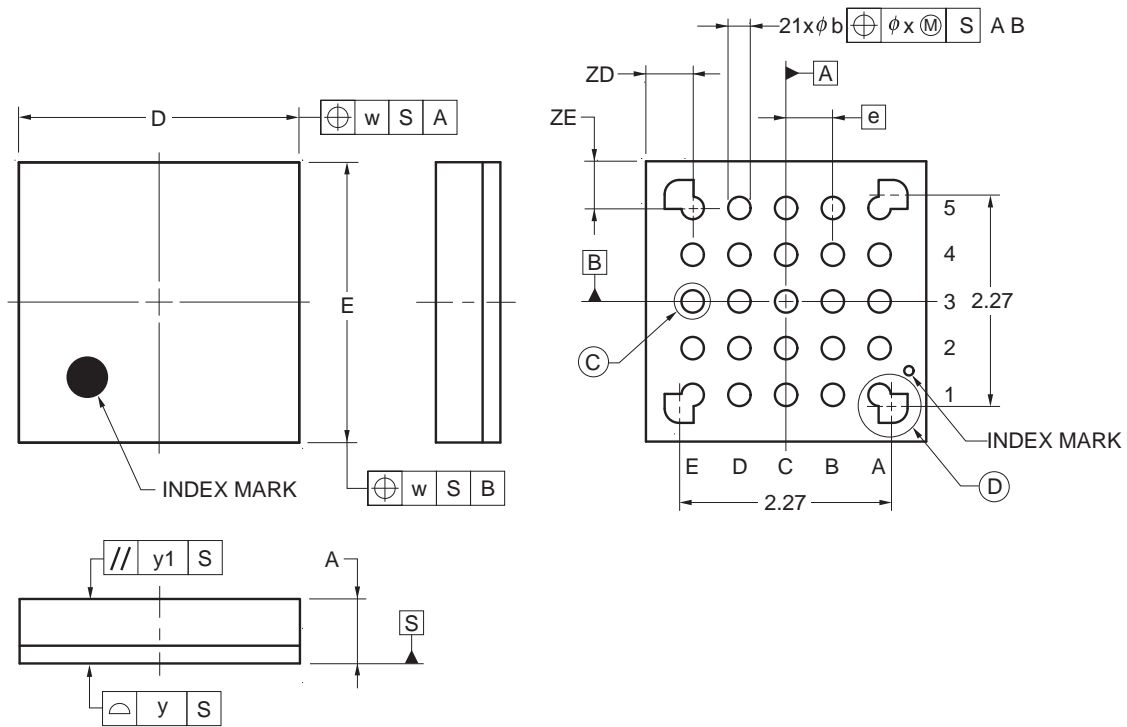

DETAIL OF © PART

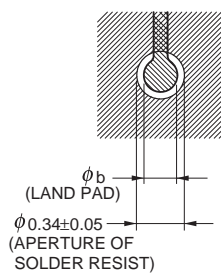

DETAIL OF © PART

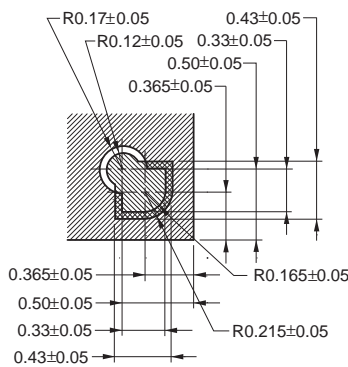

ITEM	DIMENSIONS
D	3.00±0.10
E	3.00±0.10
w	0.20
e	0.50
A	0.69±0.07
b	0.24±0.05
x	0.05
y	0.08
y1	0.20
ZD	0.50
ZE	0.50

© 2014 Renesas Electronics Corporation. All rights reserved.



4.2 32-pin products

R5F10EBAANA, R5F10EBCANA, R5F10EBDANA, R5F10EBEANA  
 R5F10EBAGNA, R5F10EBCGNA, R5F10EBDGNA, R5F10EBEGNA

JEITA Package code	RENESAS code	Previous code	MASS(TYP.)[g]
P-HWQFN32-5x5-0.50	PWQN0032KB-A	P32K8-50-3B4-5	0.06

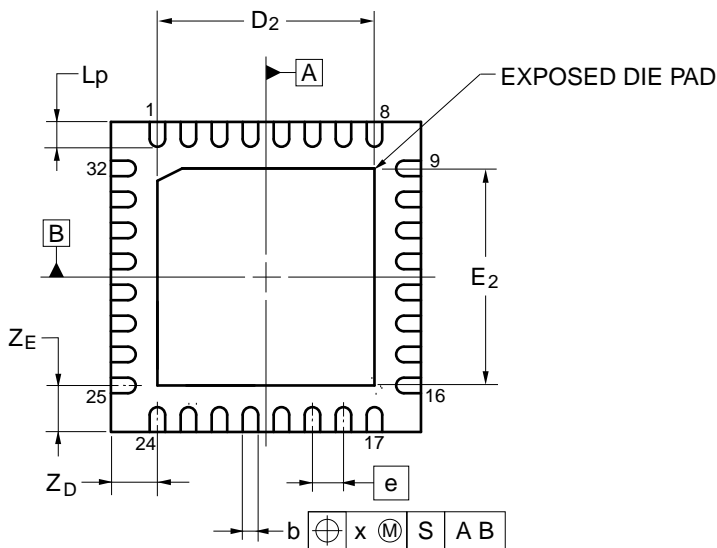
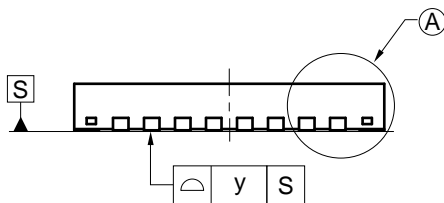
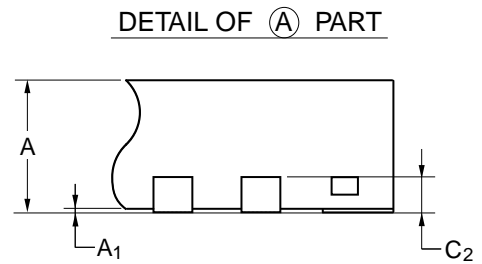
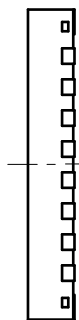
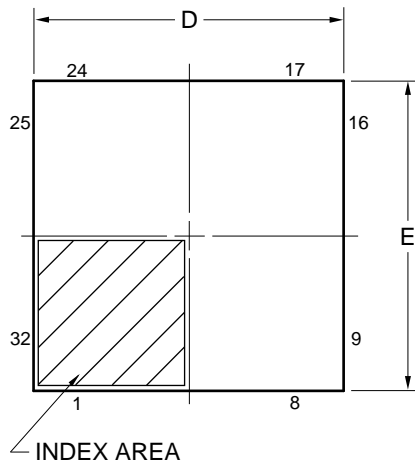

Reference Symbol	Dimension in Millimeters		
	Min	Nom	Max
D	4.95	5.00	5.05
E	4.95	5.00	5.05
A	—	—	0.80
A <sub>1</sub>	0.00	—	—
b	0.18	0.25	0.30
e	—	0.50	—
L <sub>p</sub>	0.30	0.40	0.50
x	—	—	0.05
y	—	—	0.05
Z <sub>D</sub>	—	0.75	—
Z <sub>E</sub>	—	0.75	—
c <sub>2</sub>	0.15	0.20	0.25
D <sub>2</sub>	—	3.50	—
E <sub>2</sub>	—	3.50	—

©2013 Renesas Electronics Corporation. All rights reserved.

4.3 48-pin products

R5F10EGAAFB, R5F10EGCAFB, R5F10EGDAFB, R5F10EGEAFB  
 R5F10EGAGFB, R5F10EGCGFB, R5F10EGDGF, R5F10EGEGFB

JEITA Package Code	RENESAS Code	Previous Code	MASS (TYP.) [g]
P-LFQFP48-7x7-0.50	PLQP0048KF-A	P48GA-50-8EU-1	0.16

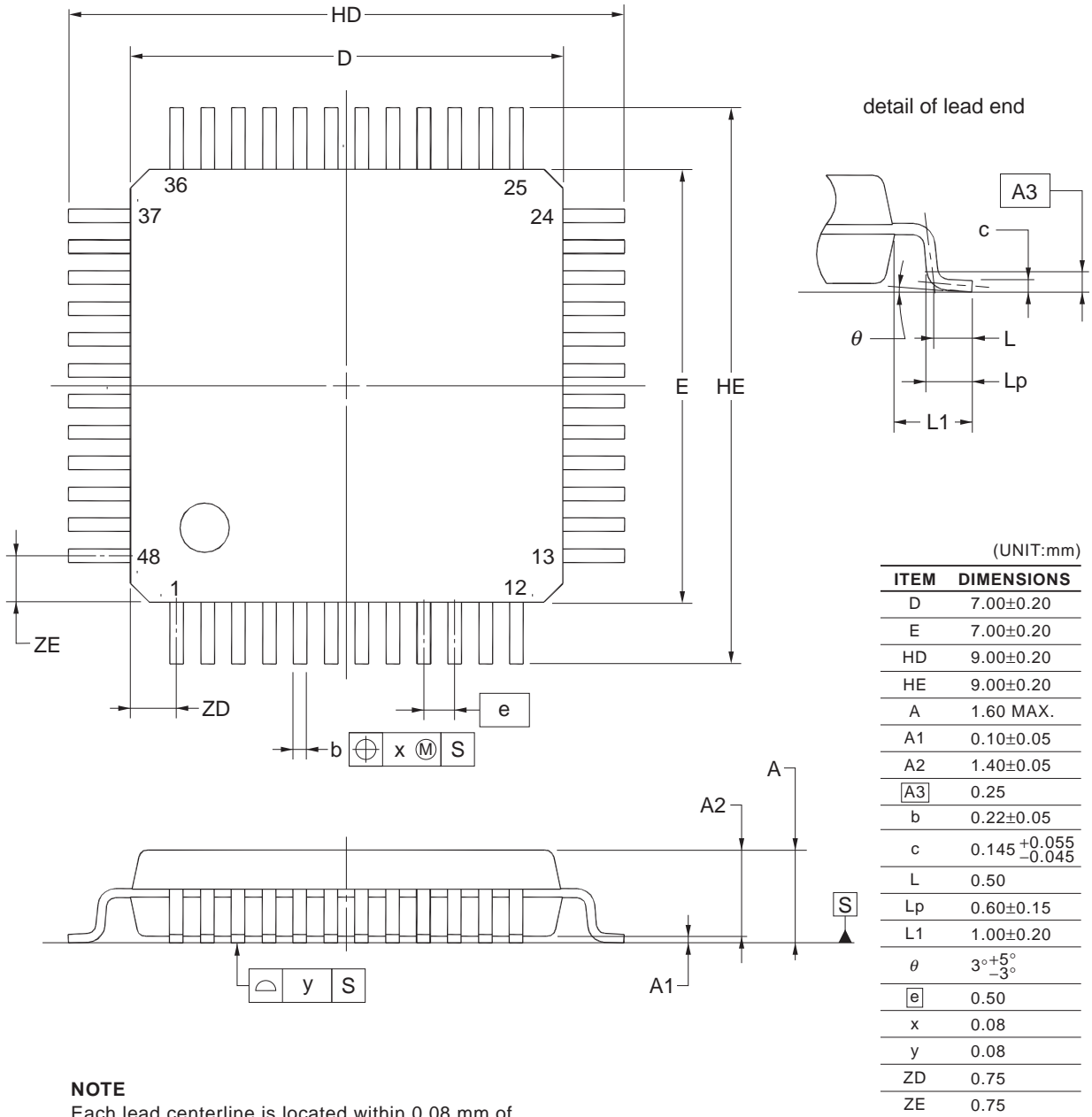

**NOTE**  
 Each lead centerline is located within 0.08 mm of its true position at maximum material condition.

R5F10EGAANA, R5F10EGCANA, R5F10EGDANA, R5F10EGEANA  
 R5F10EGAGNA, R5F10EGCGNA, R5F10EGDGNA, R5F10EGEGNA

<R>

JEITA Package Code	RENESAS Code	Previous Code	MASS (Typ) [g]
P-HWQFN48-7x7-0.50	PWQN0048KB-A	48PJN-A P48K8-50-5B4-7	0.13

Unit: mm

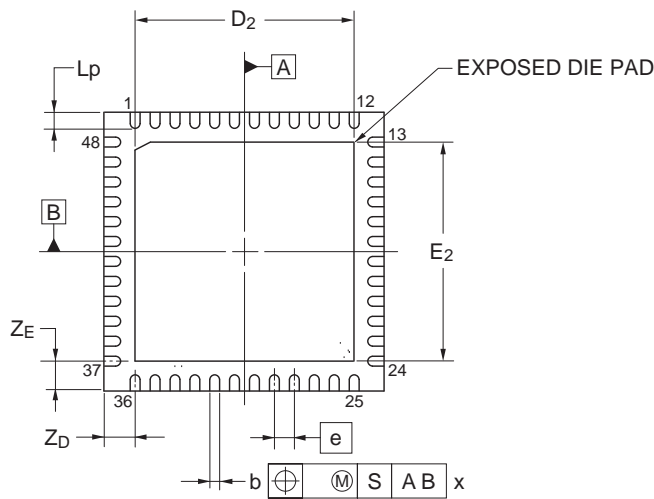
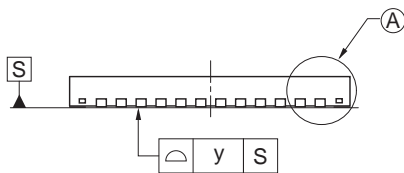
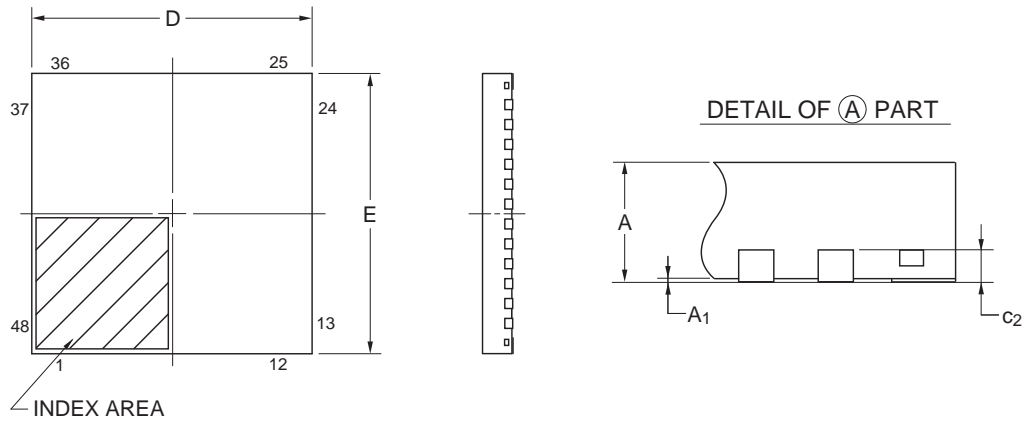

Reference Symbol	Dimensions in millimeters		
	Min	Nom	Max
D	6.95	7.00	7.05
E	6.95	7.00	7.05
A	—	—	0.80
A <sub>1</sub>	0.00	—	—
b	0.18	0.25	0.30
e	—	0.50	—
L <sub>p</sub>	0.30	0.40	0.50
x	—	—	0.05
y	—	—	0.05
Z <sub>D</sub>	—	0.75	—
Z <sub>E</sub>	—	0.75	—
c <sub>2</sub>	0.15	0.20	0.25
D <sub>2</sub>	—	5.50	—
E <sub>2</sub>	—	5.50	—

© 2015 Renesas Electronics Corporation. All rights reserved.

4.4 64-pin products

R5F10ELCAFB, R5F10ELDAFB, R5F10ELEAFB  
 R5F10ELCGFB, R5F10ELDGF, R5F10ELEGFB

JEITA Package Code	RENESAS Code	Previous Code	MASS (TYP.) [g]
P-LFQFP64-10x10-0.50	PLQP0064KF-A	P64GB-50-UEU-2	0.35

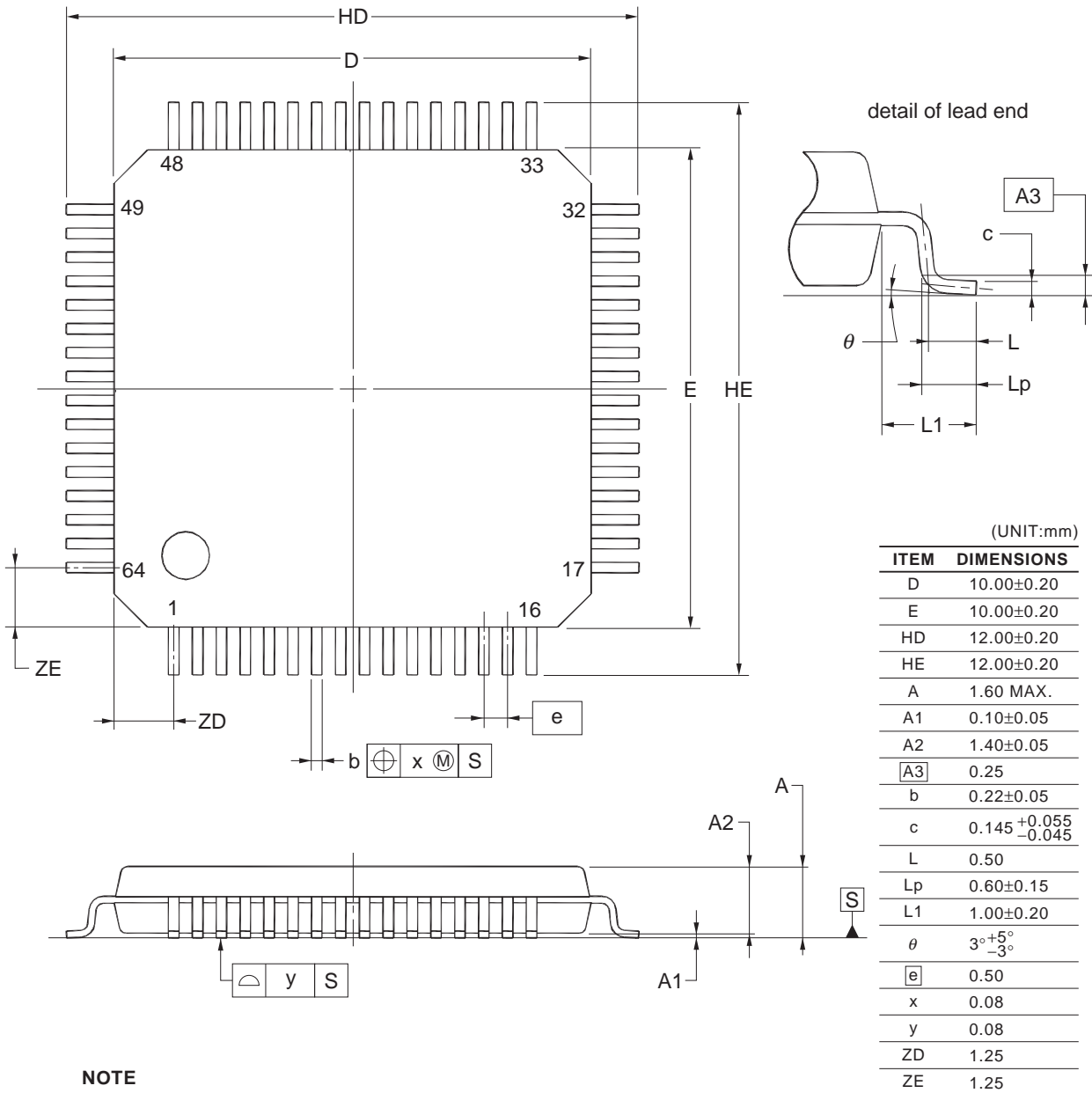

**NOTE**  
 Each lead centerline is located within 0.08 mm of its true position at maximum material condition.

R5F10ELCABG, R5F10ELDABG, R5F10ELEABG

JEITA Package Code	RENESAS Code	Previous Code	MASS (TYP.) [g]
P-VFBGA64-4x4-0.40	PVBG0064LA-A	P64F1-40-AA2-2	0.03

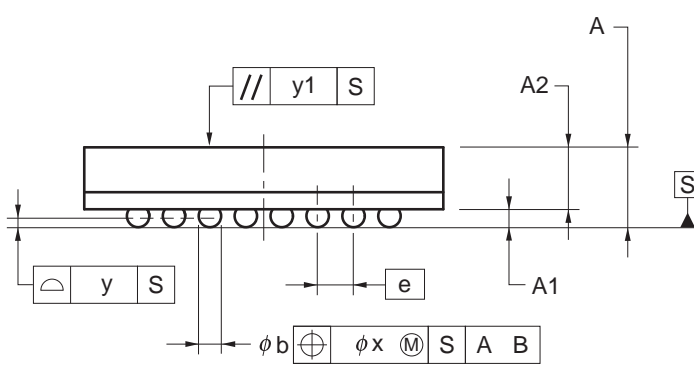
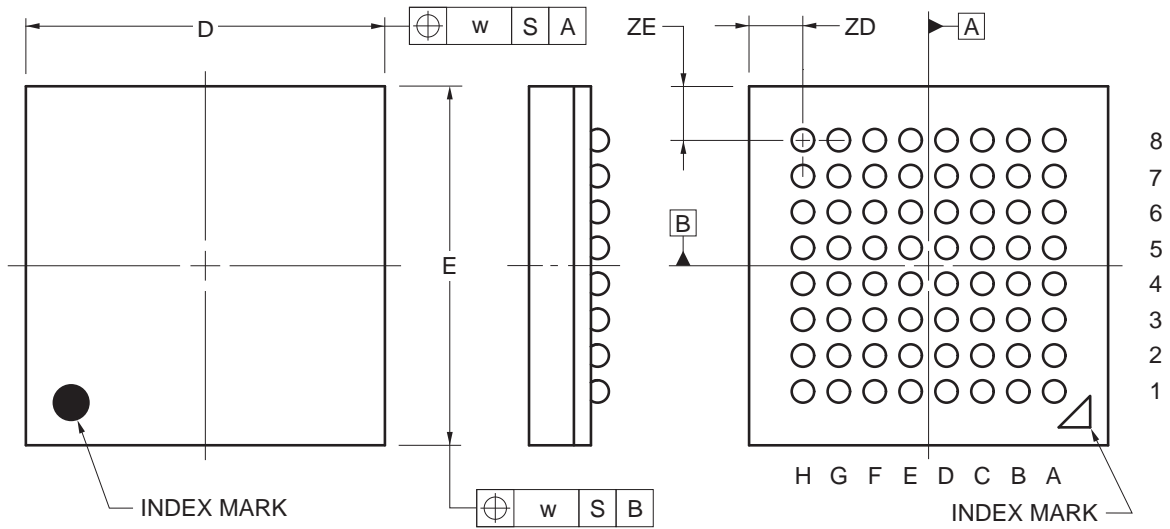

(UNIT:mm)

ITEM	DIMENSIONS
D	4.00±0.10
E	4.00±0.10
w	0.15
A	0.89±0.10
A1	0.20±0.05
A2	0.69
e	0.40
b	0.25±0.05
x	0.05
y	0.08
y1	0.20
ZD	0.60
ZE	0.60

©2012 Renesas Electronics Corporation. All rights reserved.

## Revision History

## RL78/G1A Data Sheet

Rev.	Date	Description	
		Page	Summary
0.01	Dec 26, 2011	-	First Edition issued
1.00	Sep 25, 2013	p.1	Modification of 1.1 Features
		p.4	Modification of Table 1-1. List of Ordering Part Numbers
		p.6	Modification of Remark 3 to 1.3.2 32-pin products.
		p.13	Modification of 1.5.2 32-pin products.
		p.14	Modification of 1.5.3 48-pin products.
		p.16	Modification of 1.6 Outline of Functions
		p.21	Modification of 2.2.1 X1, XT1 oscillator characteristics
		p.31, 32	Modification of Note 1 in 2.3.2 Supply current characteristics
		p.34, 35	Modification of Minimum Instruction Execution Time during Main System Clock Operation
		p.37	Modification of AC Timing Test Points in 2.5 Peripheral Functions Characteristics
		p.46 to 58	Modification of Caution to 2.5.1 Serial array unit.
		p.63 to 68	Modification of 2.6.1 A/D converter characteristics
		p.71	Modification of 2.7 Data Memory STOP Mode Low Supply Voltage Data Retention Characteristics
		p.71	Modification of 2.8 Flash Memory Programming Characteristics
p.72	Modification of 2.10 Timing Specs for Switching Flash Memory Programming Modes		
p.73 to 117	Addition of 3 ELECTRICAL SPECIFICATIONS (G: INDUSTRIAL APPLICATIONS $T_A = -40$ to $+105^\circ\text{C}$ )		
p.118 to 123	Modification of 4. PACKAGE DRAWINGS		
2.10	Nov 30, 2016	p.4	Modification of Table 1-1. List of Ordering Part Numbers
		p.5 to 10	Modification of the position of the index mark in 1.3.1 25-pin products to 1.3.4 64-pin products
		p.6	Modification of Remark 3
		p.13	Modification of 1.5.2 32-pin products
		p.14	Modification of 1.5.3 48-pin products
		p.16	Modification of description in 1.6 Outline of Functions
		p.21	Modification of 2.2.1 X1, XT1 oscillator characteristics
		p.31, 32	Modification of Note 1 in 2.3.2 Supply current characteristics
		p.34, 35	Modification of Minimum Instruction Execution Time during Main System Clock Operation
		p.36	Modification of AC Timing Test Points and TI/TO Timing
		p.38	Modification of AC Timing Test Points in 2.5 Peripheral Functions Characteristics
		p.48, 50 to 52, 55, 59	Modification of Caution in 2.5.1 Serial array unit
		p.64 to 69	Modification of conditions of 2.6.1 A/D converter characteristics
		p.72	Renamed to 2.7 RAM Data Retention Characteristics, and modification of note and figure
p.72	Modification of 2.8 Flash Memory Programming Characteristics		

Rev.	Date	Description	
		Page	Summary
2.10	Nov 30, 2016	p.73	Modification of 2.10 Timing Specs for Switching Flash Memory Programming Modes
		p.77	Modification of 3.2.1 X1, XT1 oscillator characteristics
		p.78, 79	Modification of 3.3.1 Pin characteristics
		p.88	Modification of 3.3.2 Supply current characteristics
		p.90	Modification of Minimum Instruction Execution Time during Main System Clock Operation
		p.91	Modification of AC Timing Test Points and TI/TO Timing
		p.93	Modification of AC Timing Test Points in 3.5 Peripheral Functions Characteristics
		p.95	Modification of 3.5.1 Serial array unit
		p.99, 100, 102, 103, 105, 109	Modification of Caution in 2.5.1 Serial array unit
		p.112 to 116	Modification of 3.6.1 (1) to (5)
		p.118	Renamed to 3.7 RAM Data Retention Characteristics, and modification of note and figure
		p.118	Addition of note 4 to 3.8 Flash Memory Programming Characteristics
		p.119	Modification of 3.10 Timing Specs for Switching Flash Memory Programming Modes
		p.120	Modification of 4.1 25-pin products
p.123	Modification of 4.3 48-pin products		

All trademarks and registered trademarks are the property of their respective owners

SuperFlash is a registered trademark of Silicon Storage Technology, Inc. in several countries including the United States and Japan.

Caution: This product uses SuperFlash® technology licensed from Silicon Storage Technology, Inc.
--

## NOTES FOR CMOS DEVICES

- (1) **VOLTAGE APPLICATION WAVEFORM AT INPUT PIN:** Waveform distortion due to input noise or a reflected wave may cause malfunction. If the input of the CMOS device stays in the area between VIL (MAX) and VIH (MIN) due to noise, etc., the device may malfunction. Take care to prevent chattering noise from entering the device when the input level is fixed, and also in the transition period when the input level passes through the area between VIL (MAX) and VIH (MIN).
- (2) **HANDLING OF UNUSED INPUT PINS:** Unconnected CMOS device inputs can be cause of malfunction. If an input pin is unconnected, it is possible that an internal input level may be generated due to noise, etc., causing malfunction. CMOS devices behave differently than Bipolar or NMOS devices. Input levels of CMOS devices must be fixed high or low by using pull-up or pull-down circuitry. Each unused pin should be connected to VDD or GND via a resistor if there is a possibility that it will be an output pin. All handling related to unused pins must be judged separately for each device and according to related specifications governing the device.
- (3) **PRECAUTION AGAINST ESD:** A strong electric field, when exposed to a MOS device, can cause destruction of the gate oxide and ultimately degrade the device operation. Steps must be taken to stop generation of static electricity as much as possible, and quickly dissipate it when it has occurred. Environmental control must be adequate. When it is dry, a humidifier should be used. It is recommended to avoid using insulators that easily build up static electricity. Semiconductor devices must be stored and transported in an anti-static container, static shielding bag or conductive material. All test and measurement tools including work benches and floors should be grounded. The operator should be grounded using a wrist strap. Semiconductor devices must not be touched with bare hands. Similar precautions need to be taken for PW boards with mounted semiconductor devices.
- (4) **STATUS BEFORE INITIALIZATION:** Power-on does not necessarily define the initial status of a MOS device. Immediately after the power source is turned ON, devices with reset functions have not yet been initialized. Hence, power-on does not guarantee output pin levels, I/O settings or contents of registers. A device is not initialized until the reset signal is received. A reset operation must be executed immediately after power-on for devices with reset functions.
- (5) **POWER ON/OFF SEQUENCE:** In the case of a device that uses different power supplies for the internal operation and external interface, as a rule, switch on the external power supply after switching on the internal power supply. When switching the power supply off, as a rule, switch off the external power supply and then the internal power supply. Use of the reverse power on/off sequences may result in the application of an overvoltage to the internal elements of the device, causing malfunction and degradation of internal elements due to the passage of an abnormal current. The correct power on/off sequence must be judged separately for each device and according to related specifications governing the device.
- (6) **INPUT OF SIGNAL DURING POWER OFF STATE :** Do not input signals or an I/O pull-up power supply while the device is not powered. The current injection that results from input of such a signal or I/O pull-up power supply may cause malfunction and the abnormal current that passes in the device at this time may cause degradation of internal elements. Input of signals during the power off state must be judged separately for each device and according to related specifications governing the device.



## Notice

1. Descriptions of circuits, software and other related information in this document are provided only to illustrate the operation of semiconductor products and application examples. You are fully responsible for the incorporation of these circuits, software, and information in the design of your equipment. Renesas Electronics assumes no responsibility for any losses incurred by you or third parties arising from the use of these circuits, software, or information.
2. Renesas Electronics has used reasonable care in preparing the information included in this document, but Renesas Electronics does not warrant that such information is error free. Renesas Electronics assumes no liability whatsoever for any damages incurred by you resulting from errors in or omissions from the information included herein.
3. Renesas Electronics does not assume any liability for infringement of patents, copyrights, or other intellectual property rights of third parties by or arising from the use of Renesas Electronics products or technical information described in this document. No license, express, implied or otherwise, is granted hereby under any patents, copyrights or other intellectual property rights of Renesas Electronics or others.
4. You should not alter, modify, copy, or otherwise misappropriate any Renesas Electronics product, whether in whole or in part. Renesas Electronics assumes no responsibility for any losses incurred by you or third parties arising from such alteration, modification, copy or otherwise misappropriation of Renesas Electronics product.
5. Renesas Electronics products are classified according to the following two quality grades: "Standard" and "High Quality". The recommended applications for each Renesas Electronics product depends on the product's quality grade, as indicated below.  
"Standard": Computers; office equipment; communications equipment; test and measurement equipment; audio and visual equipment; home electronic appliances; machine tools; personal electronic equipment; and industrial robots etc.  
"High Quality": Transportation equipment (automobiles, trains, ships, etc.); traffic control systems; anti-disaster systems; anti-crime systems; and safety equipment etc.  
Renesas Electronics products are neither intended nor authorized for use in products or systems that may pose a direct threat to human life or bodily injury (artificial life support devices or systems, surgical implantations etc.), or may cause serious property damages (nuclear reactor control systems, military equipment etc.). You must check the quality grade of each Renesas Electronics product before using it in a particular application. You may not use any Renesas Electronics product for any application for which it is not intended. Renesas Electronics shall not be in any way liable for any damages or losses incurred by you or third parties arising from the use of any Renesas Electronics product for which the product is not intended by Renesas Electronics.
6. You should use the Renesas Electronics products described in this document within the range specified by Renesas Electronics, especially with respect to the maximum rating, operating supply voltage range, movement power voltage range, heat radiation characteristics, installation and other product characteristics. Renesas Electronics shall have no liability for malfunctions or damages arising out of the use of Renesas Electronics products beyond such specified ranges.
7. Although Renesas Electronics endeavors to improve the quality and reliability of its products, semiconductor products have specific characteristics such as the occurrence of failure at a certain rate and malfunctions under certain use conditions. Further, Renesas Electronics products are not subject to radiation resistance design. Please be sure to implement safety measures to guard them against the possibility of physical injury, and injury or damage caused by fire in the event of the failure of a Renesas Electronics product, such as safety design for hardware and software including but not limited to redundancy, fire control and malfunction prevention, appropriate treatment for aging degradation or any other appropriate measures. Because the evaluation of microcomputer software alone is very difficult, please evaluate the safety of the final products or systems manufactured by you.
8. Please contact a Renesas Electronics sales office for details as to environmental matters such as the environmental compatibility of each Renesas Electronics product. Please use Renesas Electronics products in compliance with all applicable laws and regulations that regulate the inclusion or use of controlled substances, including without limitation, the EU RoHS Directive. Renesas Electronics assumes no liability for damages or losses occurring as a result of your noncompliance with applicable laws and regulations.
9. Renesas Electronics products and technology may not be used for or incorporated into any products or systems whose manufacture, use, or sale is prohibited under any applicable domestic or foreign laws or regulations. You should not use Renesas Electronics products or technology described in this document for any purpose relating to military applications or use by the military, including but not limited to the development of weapons of mass destruction. When exporting the Renesas Electronics products or technology described in this document, you should comply with the applicable export control laws and regulations and follow the procedures required by such laws and regulations.
10. It is the responsibility of the buyer or distributor of Renesas Electronics products, who distributes, disposes of, or otherwise places the product with a third party, to notify such third party in advance of the contents and conditions set forth in this document, Renesas Electronics assumes no responsibility for any losses incurred by you or third parties as a result of unauthorized use of Renesas Electronics products.
11. This document may not be reproduced or duplicated in any form, in whole or in part, without prior written consent of Renesas Electronics.
12. Please contact a Renesas Electronics sales office if you have any questions regarding the information contained in this document or Renesas Electronics products, or if you have any other inquiries.

(Note 1) "Renesas Electronics" as used in this document means Renesas Electronics Corporation and also includes its majority-owned subsidiaries.

(Note 2) "Renesas Electronics product(s)" means any product developed or manufactured by or for Renesas Electronics.



### SALES OFFICES

Renesas Electronics Corporation

<http://www.renesas.com>

Refer to "<http://www.renesas.com/>" for the latest and detailed information.

#### **Renesas Electronics America Inc.**

2801 Scott Boulevard Santa Clara, CA 95050-2549, U.S.A.  
Tel: +1-408-588-6000, Fax: +1-408-588-6130

#### **Renesas Electronics Canada Limited**

9251 Yonge Street, Suite 8309 Richmond Hill, Ontario Canada L4C 9T3  
Tel: +1-905-237-2004

#### **Renesas Electronics Europe Limited**

Dukes Meadow, Millboard Road, Bourne End, Buckinghamshire, SL8 5FH, U.K  
Tel: +44-1628-585-100, Fax: +44-1628-585-900

#### **Renesas Electronics Europe GmbH**

Arcadiastrasse 10, 40472 Düsseldorf, Germany  
Tel: +49-211-6503-0, Fax: +49-211-6503-1327

#### **Renesas Electronics (China) Co., Ltd.**

Room 1709, Quantum Plaza, No.27 ZhiChunLu Haidian District, Beijing 100191, P.R.China  
Tel: +86-10-8235-1155, Fax: +86-10-8235-7679

#### **Renesas Electronics (Shanghai) Co., Ltd.**

Unit 301, Tower A, Central Towers, 555 Langao Road, Putuo District, Shanghai, P. R. China 200333  
Tel: +86-21-2226-0888, Fax: +86-21-2226-0999

#### **Renesas Electronics Hong Kong Limited**

Unit 1601-1611, 16/F., Tower 2, Grand Century Place, 193 Prince Edward Road West, Mongkok, Kowloon, Hong Kong  
Tel: +852-2265-6688, Fax: +852 2886-9022

#### **Renesas Electronics Taiwan Co., Ltd.**

13F, No. 363, Fu Shing North Road, Taipei 10543, Taiwan  
Tel: +886-2-8175-9600, Fax: +886 2-8175-9670

#### **Renesas Electronics Singapore Pte. Ltd.**

80 Bendemeer Road, Unit #06-02 Hyflux Innovation Centre, Singapore 339949  
Tel: +65-6213-0200, Fax: +65-6213-0300

#### **Renesas Electronics Malaysia Sdn.Bhd.**

Unit 1207, Block B, Menara Amcorp, Amcorp Trade Centre, No. 18, Jln Persiaran Barat, 46050 Petaling Jaya, Selangor Darul Ehsan, Malaysia  
Tel: +60-3-7955-9390, Fax: +60-3-7955-9510

#### **Renesas Electronics India Pvt. Ltd.**

No.777C, 100 Feet Road, HAL II Stage, Indiranagar, Bangalore, India  
Tel: +91-80-67208700, Fax: +91-80-67208777

#### **Renesas Electronics Korea Co., Ltd.**

12F., 234 Teheran-ro, Gangnam-Gu, Seoul, 135-080, Korea  
Tel: +82-2-558-3737, Fax: +82-2-558-5141

# Mouser Electronics

Authorized Distributor

Click to View Pricing, Inventory, Delivery & Lifecycle Information:

## Renesas Electronics:

[R5F10ELCAFB#V0](#) [R5F10EGCANA#U0](#) [R5F10EGEAFB#V0](#) [R5F10EBEANA#U0](#) [R5F10EGCAFB#V0](#)  
[R5F10E8EALA#U0](#) [R5F10ELDADF#V0](#) [R5F10FLCANA#U0](#) [R5F10FMDADF#V0](#) [R5F10FMCAFB#V0](#)  
[R5F10FMEAFB#V0](#) [R5F10ELDABG#U0](#) [R5F10EGCGFB#V0](#) [R5F10EGEANA#U0](#) [R5F10EGEGFB#V0](#)  
[R5F10E8CALA#U0](#) [R5F10EGDANA#U0](#) [R5F10FLDANA#U0](#) [R5F10FLEANA#U0](#) [R5F10EGDAFB#V0](#)  
[R5F10ELCABG#U0](#) [R5F10ELEAFB#V0](#) [R5F10ELEGFB#V0](#) [R5F10EBAANA#U0](#) [R5F10EGAANA#U0](#)  
[R5F10E8AALA#U0](#) [R5F10ELEABG#U0](#) [R5F10E8DALA#U0](#) [R5F10EBCANA#U0](#) [R5F10EBDANA#U0](#)  
[R5F10EGAAFB#V0](#) [R5F10ELEGFB#X0](#) [R5F10E8AALA#W0](#) [R5F10E8AGLA#U0](#) [R5F10E8AGLA#W0](#)  
[R5F10E8CALA#W0](#) [R5F10E8CGLA#U0](#) [R5F10E8CGLA#W0](#) [R5F10ELEGBG#U0](#) [R5F10ELEGBG#W0](#)  
[R5F10ELDGBG#U0](#) [R5F10ELDGBG#W0](#) [R5F10ELDGFB#V0](#) [R5F10ELDGFB#X0](#) [R5F10ELEABG#W0](#)  
[R5F10ELEAFB#X0](#) [R5F10ELCGBG#U0](#) [R5F10ELCGBG#W0](#) [R5F10ELCGFB#V0](#) [R5F10ELCGFB#X0](#)  
[R5F10ELDABG#W0](#) [R5F10ELDADF#X0](#) [R5F10EGEANA#W0](#) [R5F10EGEGFB#X0](#) [R5F10EGEGNA#U0](#)  
[R5F10EGEGNA#W0](#) [R5F10ELCABG#W0](#) [R5F10ELCAFB#X0](#) [R5F10EGDANA#W0](#) [R5F10EGDGFB#W0](#)  
[R5F10EGDGFB#X0](#) [R5F10EGDGNA#U0](#) [R5F10EGDGNA#W0](#) [R5F10EGEAFB#X0](#) [R5F10EGCAFB#X0](#)  
[R5F10EGCANA#W0](#) [R5F10EGCGFB#X0](#) [R5F10EGCGNA#U0](#) [R5F10EGCGNA#W0](#) [R5F10EGDAFB#X0](#)  
[R5F10EGAAFB#X0](#) [R5F10EGAANA#W0](#) [R5F10EGAGFB#V0](#) [R5F10EGAGFB#X0](#) [R5F10EGAGNA#U0](#)  
[R5F10EGAGNA#W0](#) [R5F10EBDANA#W0](#) [R5F10EBDGNA#U0](#) [R5F10EBDGNA#W0](#) [R5F10EBEANA#W0](#)  
[R5F10EBEGNA#U0](#) [R5F10EBEGNA#W0](#) [R5F10EBAANA#W0](#) [R5F10EBAGNA#U0](#) [R5F10EBAGNA#W0](#)  
[R5F10EBCANA#W0](#) [R5F10EBCGNA#U0](#) [R5F10EBCGNA#W0](#) [R5F10E8DALA#W0](#) [R5F10E8DGLA#U0](#)  
[R5F10E8DGLA#W0](#) [R5F10E8EALA#W0](#) [R5F10E8EGLA#U0](#) [R5F10E8EGLA#W0](#)

Компания «Океан Электроники» предлагает заключение долгосрочных отношений при поставках импортных электронных компонентов на взаимовыгодных условиях!

Наши преимущества:

- Поставка оригинальных импортных электронных компонентов напрямую с производств Америки, Европы и Азии, а так же с крупнейших складов мира;
- Широкая линейка поставок активных и пассивных импортных электронных компонентов (более 30 млн. наименований);
- Поставка сложных, дефицитных, либо снятых с производства позиций;
- Оперативные сроки поставки под заказ (от 5 рабочих дней);
- Экспресс доставка в любую точку России;
- Помощь Конструкторского Отдела и консультации квалифицированных инженеров;
- Техническая поддержка проекта, помощь в подборе аналогов, поставка прототипов;
- Поставка электронных компонентов под контролем ВП;
- Система менеджмента качества сертифицирована по Международному стандарту ISO 9001;
- При необходимости вся продукция военного и аэрокосмического назначения проходит испытания и сертификацию в лаборатории (по согласованию с заказчиком);
- Поставка специализированных компонентов военного и аэрокосмического уровня качества (Xilinx, Altera, Analog Devices, Intersil, Interpoint, Microsemi, Actel, Aeroflex, Peregrine, VPT, Syfer, Eurofarad, Texas Instruments, MS Kennedy, Miteq, Cobham, E2V, MA-COM, Hittite, Mini-Circuits, General Dynamics и др.);

Компания «Океан Электроники» является официальным дистрибьютором и эксклюзивным представителем в России одного из крупнейших производителей разъемов военного и аэрокосмического назначения «JONHON», а так же официальным дистрибьютором и эксклюзивным представителем в России производителя высокотехнологичных и надежных решений для передачи СВЧ сигналов «FORSTAR».



## JONHON

«JONHON» (основан в 1970 г.)

Разъемы специального, военного и аэрокосмического назначения:

(Применяются в военной, авиационной, аэрокосмической, морской, железнодорожной, горно- и нефтедобывающей отраслях промышленности)

«FORSTAR» (основан в 1998 г.)

ВЧ соединители, коаксиальные кабели, кабельные сборки и микроволновые компоненты:

(Применяются в телекоммуникациях гражданского и специального назначения, в средствах связи, РЛС, а так же военной, авиационной и аэрокосмической отраслях промышленности).



Телефон: 8 (812) 309-75-97 (многоканальный)

Факс: 8 (812) 320-03-32

Электронная почта: [ocean@oceanchips.ru](mailto:ocean@oceanchips.ru)

Web: <http://oceanchips.ru/>

Адрес: 198099, г. Санкт-Петербург, ул. Калинина, д. 2, корп. 4, лит. А