

Applications

- Satellite Communications
- Data Link
- Radar

Product Features

- Frequency Range: 13.4 – 16.5 GHz
- P_{SAT} : 44 dBm @ PIN = 17 dBm
- PAE: >28% @ PIN = 17 dBm
- Large Signal Gain: 27 dB @ PIN = 17 dBm
- Small Signal Gain: >33 dB
- Bias: $V_D = 28$ V, $I_{DQ} = 450$ mA, $V_G = -2.5$ V Typical
- Process Technology: TQGaN15
- Chip Dimensions: 4.35 x 3.33 x 0.10 mm
- Performance Under CW Operation

Functional Block Diagram

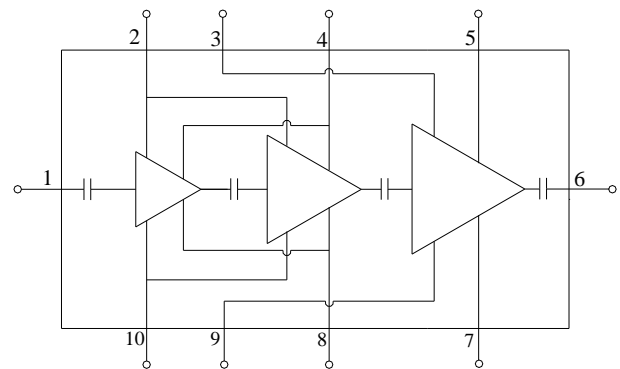

General Description

TriQuint's TGA2219 is a Ku-band, high power MMIC amplifier fabricated on TriQuint's production 0.15um GaN on SiC process. The TGA2219 operates from 13.4 – 16.5 GHz and provides 25 W of saturated output power with 27 dB of large signal gain and greater than 28% power-added efficiency.

This high performance combination provides system designers the flexibility to improve system performance while reducing size and cost.

The TGA2219 is fully matched to 50 Ohms with integrated DC blocking capacitors on RF ports simplifying system integration. It is ideally suited for military and commercial Ku-band radar and satellite communication systems.

Lead-free and RoHS compliant.

Evaluation boards are available upon request.

Pad Configuration

Pad No.	Symbol
1	RF In
2, 10	V_{G12}
3, 9	V_{G3}
4, 8	V_{D12}
5, 7	V_{D3}
6	RF Out

Ordering Information

Part	ECCN	Description
TGA2219	3A001.b.2.c	13.4 – 16.5 GHz 25 W GaN Power Amplifier

Absolute Maximum Ratings

Parameter	Value
Drain Voltage (V_D)	29.5 V
Gate Voltage Range (V_G)	-8 to -0 V
Drain Current (I_{D1-2})	2.9 A
Drain Current (I_{D3})	4.3 A
Gate Current	See plot on page 3
Power Dissipation (P_{DISS}), 85°C, CW	73 W
Input Power (P_{IN}), CW, 50Ω, $V_D = 28$ V, $I_{DQ} = 450$ mA, 85°C	30 dBm
Input Power (P_{IN}), CW, VSWR 3:1, $V_D = 28$ V, $I_{DQ} = 450$ mA, 85°C	27 dBm
Channel Temperature (T_{CH})	275°C
Mounting Temperature (30 seconds)	320°C
Storage Temperature	-40 to 150°C

Operation of this device outside the parameter ranges given above may cause permanent damage. These are stress ratings only, and functional operation of the device at these conditions is not implied.

Recommended Operating Conditions

Parameter	Value
Drain Voltage (V_D)	28 V
Drain Current (I_{DQ})	450 mA (Total)
Gate Voltage (V_G)	-2.5 V (Typ.)

Electrical specifications are measured at specified test conditions. Specifications are not guaranteed over all recommended operating conditions.

Electrical Specifications

Test conditions unless otherwise noted: 25°C, $V_D = 28$ V, $I_{DQ} = 450$ mA, $V_G = -2.5$ V Typical, CW

Parameter	Min	Typical	Max	Units
Operational Frequency Range	13.4		16.5	GHz
Small Signal Gain		> 33		dB
Input Return Loss		> 11		dB
Output Return Loss		> 5		dB
Power Gain ($P_{in} = 17$ dBm)		27		dB
Output Power ($P_{in} = 17$ dBm)		44		dBm
Power Added Efficiency ($P_{in} = 17$ dBm)		> 28		%
Small Signal Gain Temperature Coefficient		-0.8		dB/°C
Output Power Temperature Coefficient (Temp: 25°C – 85°C @ $P_{in} = 17$ dBm)		-0.01		dB/°C
Recommended Operating Voltage		20 to 28	28	V

Thermal and Reliability Information

Parameter	Test Conditions	Value	Units
Thermal Resistance (θ_{JC}) ⁽¹⁾	$T_{base} = 85^{\circ}C$	2.54	$^{\circ}C/W$
Channel Temperature (T_{CH}) (No RF drive)	$V_D = 28 V, I_{DQ} = 450 mA$	117	$^{\circ}C$
Median Lifetime (T_M)	$P_{DISS} = 12.6 W$	4.3×10^{11}	Hrs
Thermal Resistance (θ_{JC}) ⁽¹⁾	$T_{base} = 85^{\circ}C, CW, V_D = 28 V, I_{DQ} = 450 mA$	2.57	$^{\circ}C/W$
Channel Temperature (T_{CH}) (Under RF drive)	Freq = 14.0 GHz, $I_{D_Drive} = 2.9 A,$	234	$^{\circ}C$
Median Lifetime (T_M)	$P_{IN} = 19 dBm, P_{OUT} = 44.5 dBm, P_{DISS} = 58 W$	3.66×10^6	Hrs

Notes:

1. Thermal resistance measured to back of carrier plate. MMIC mounted on 40 mils CuMo (75/25) carrier using 1.5 mil AuSn.

Median Lifetime

Test Conditions: $V_D = 28 V$; Failure Criteria = 10% reduction in I_{D_MAX}

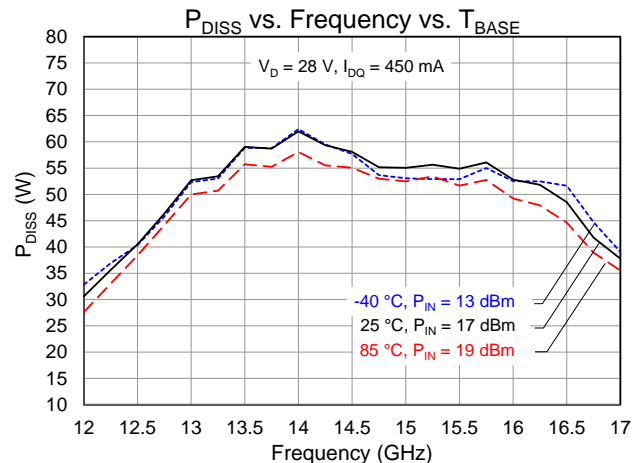
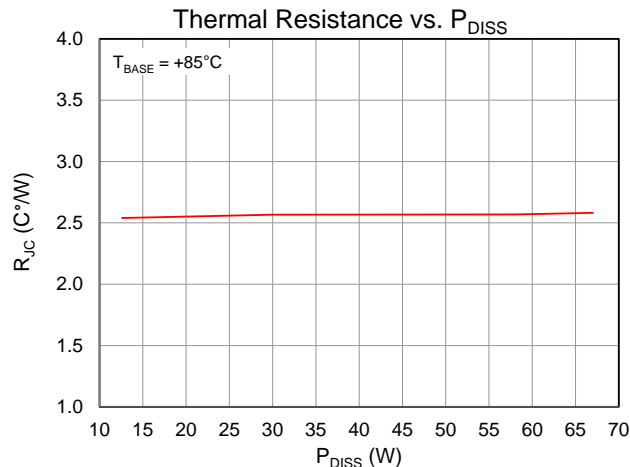
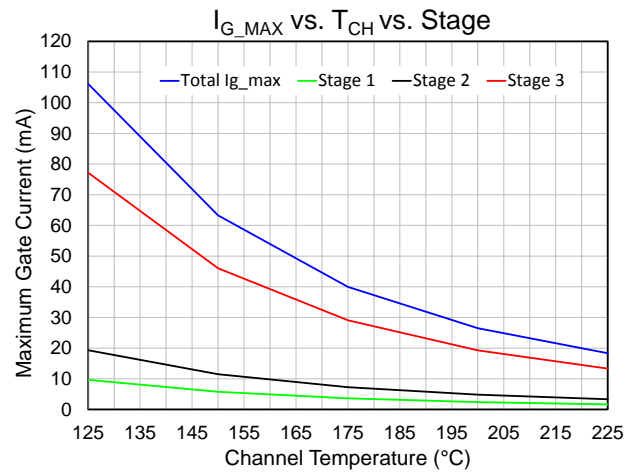
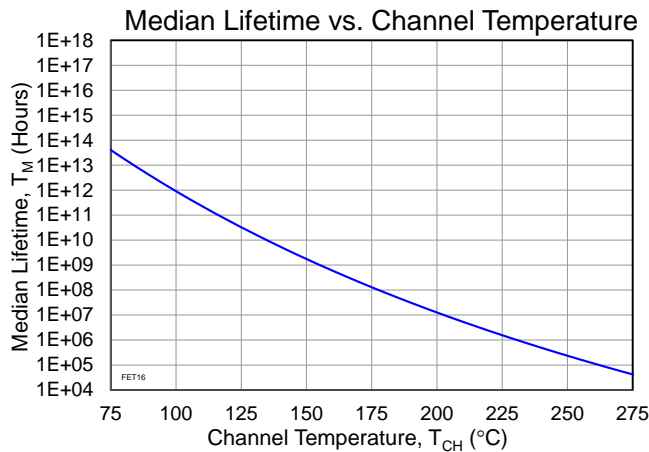

Typical Performance (Small Signal)

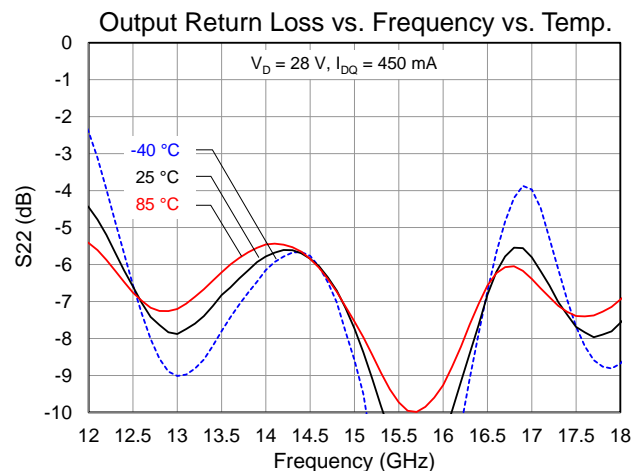
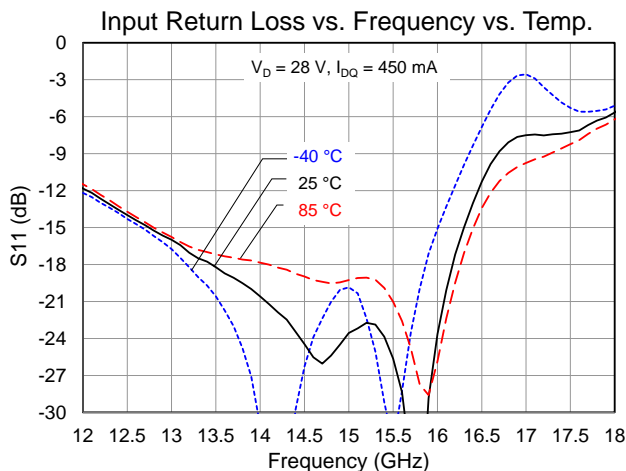
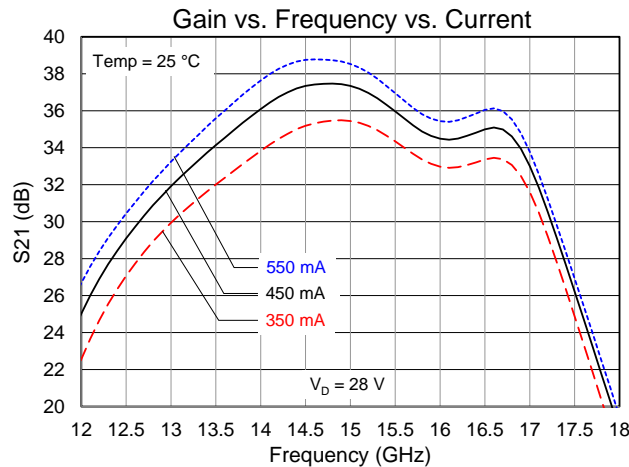
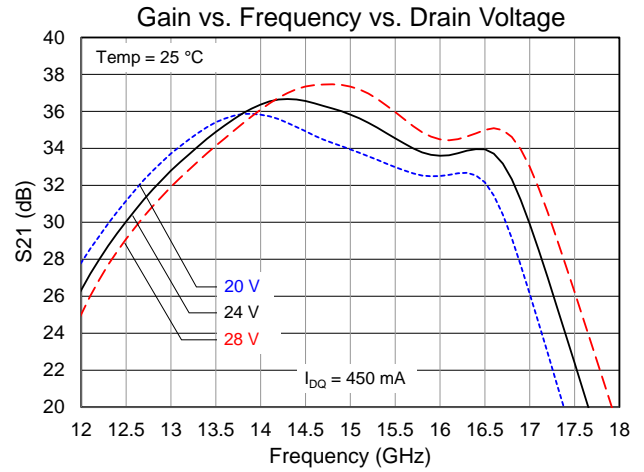
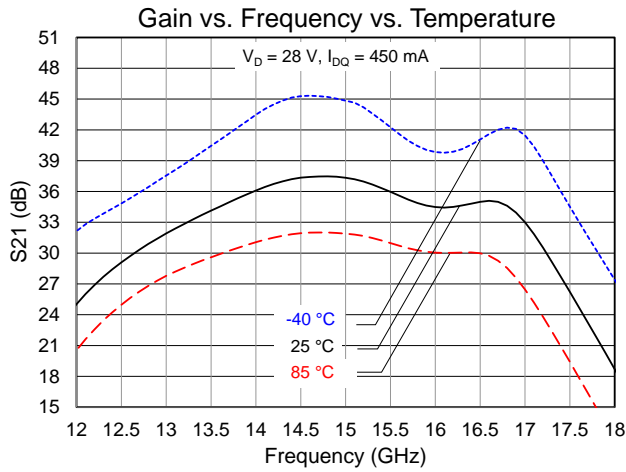

Typical Performance (CW Operation)

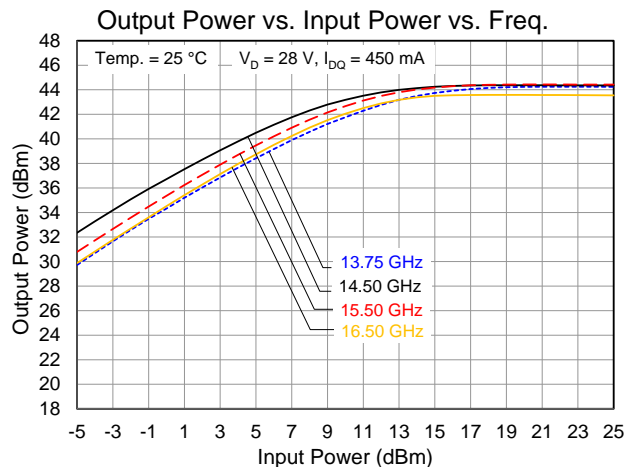
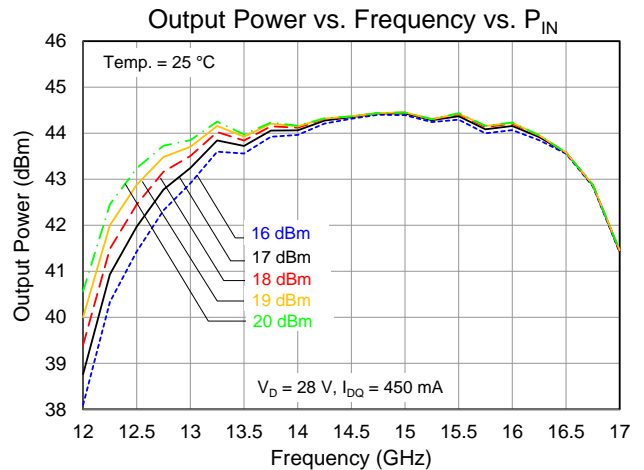
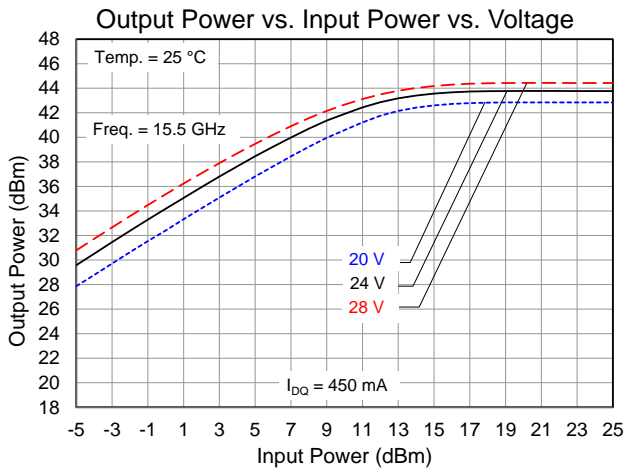
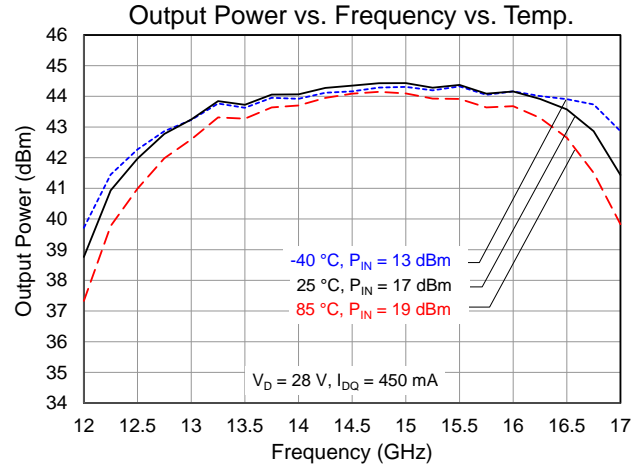
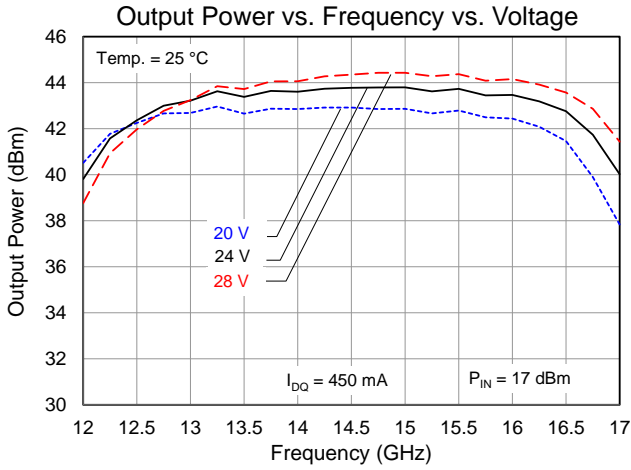

Typical Performance (CW Operation)

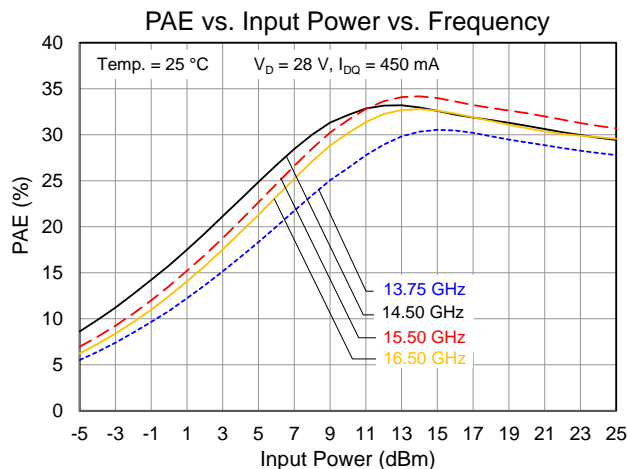
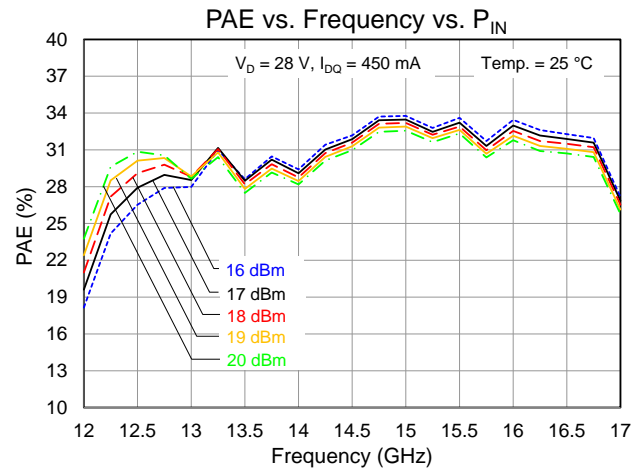
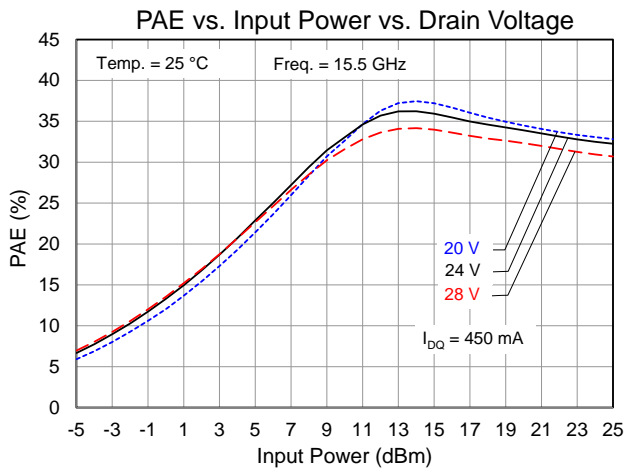
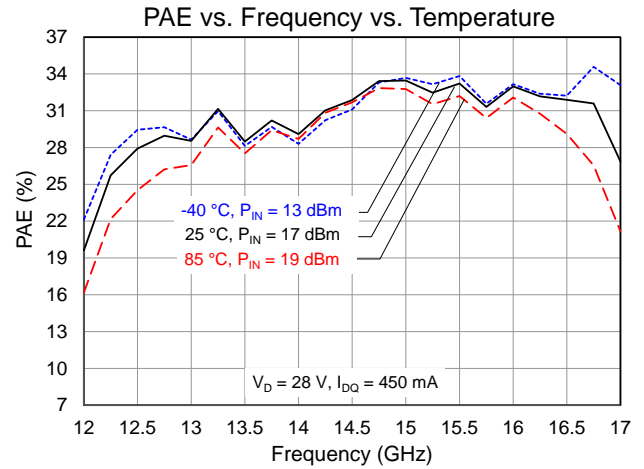
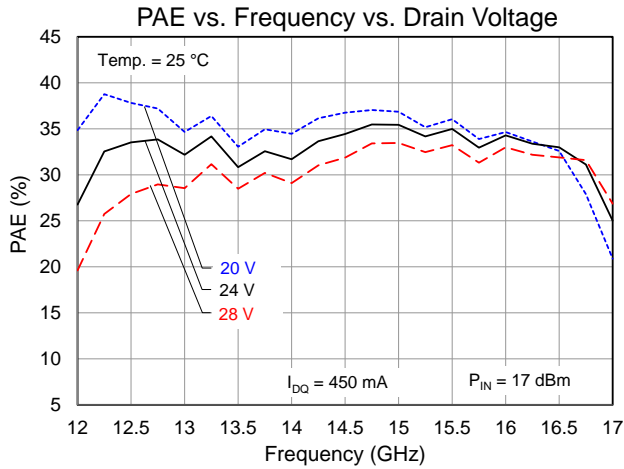

Typical Performance (CW Operation)

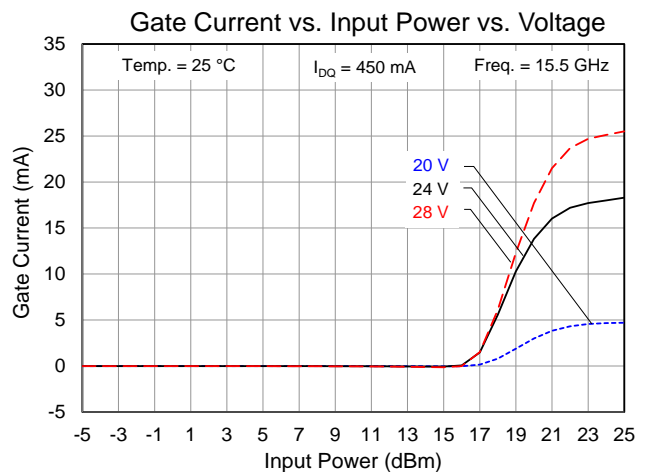
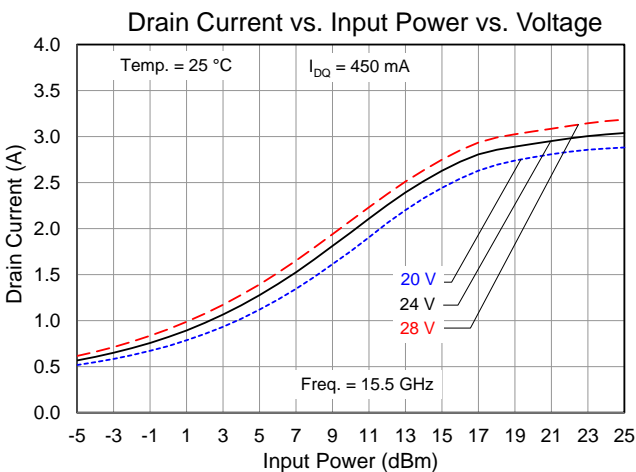
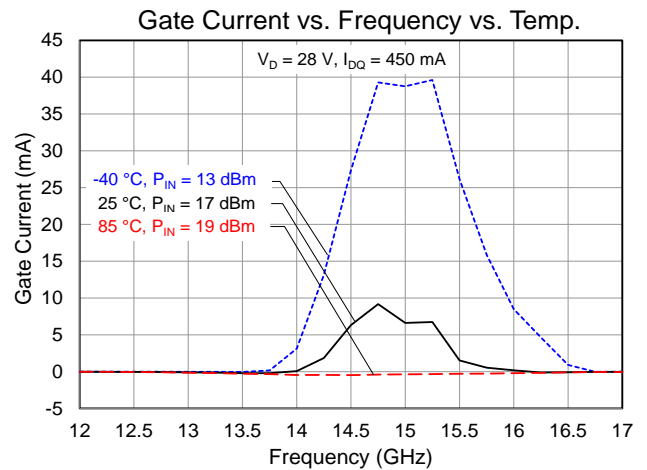
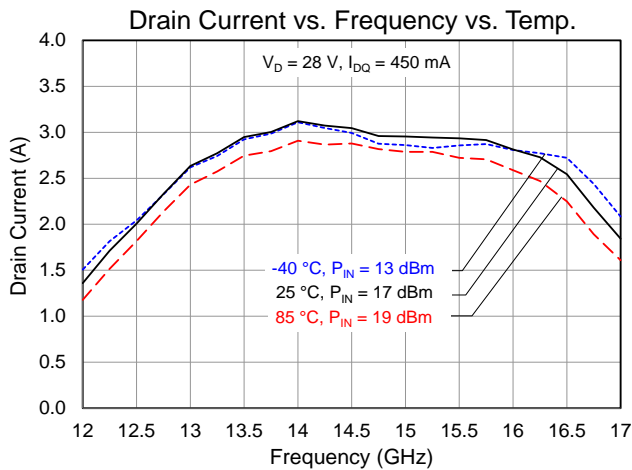
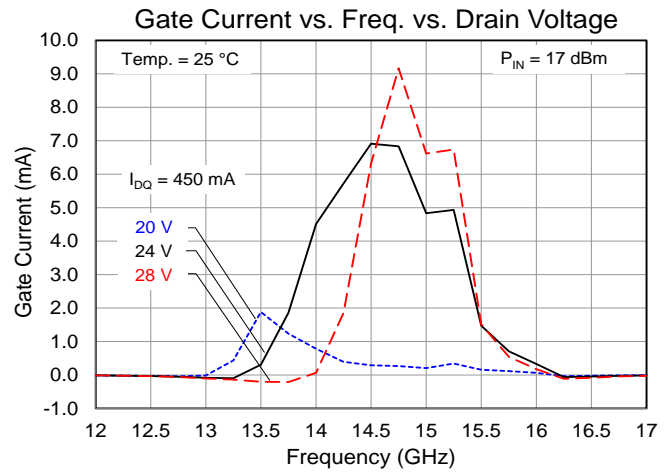
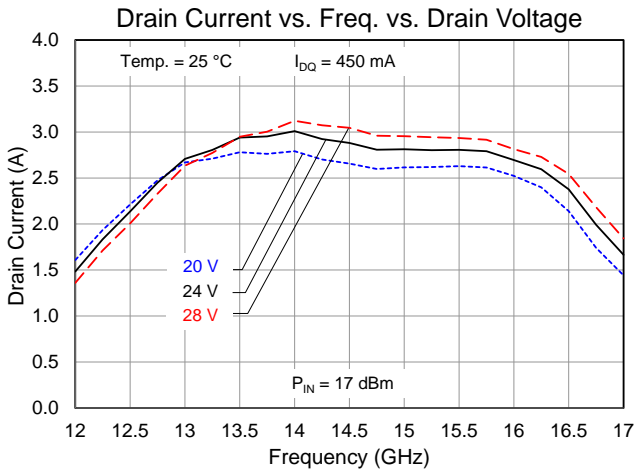

Typical Performance (CW Operation)

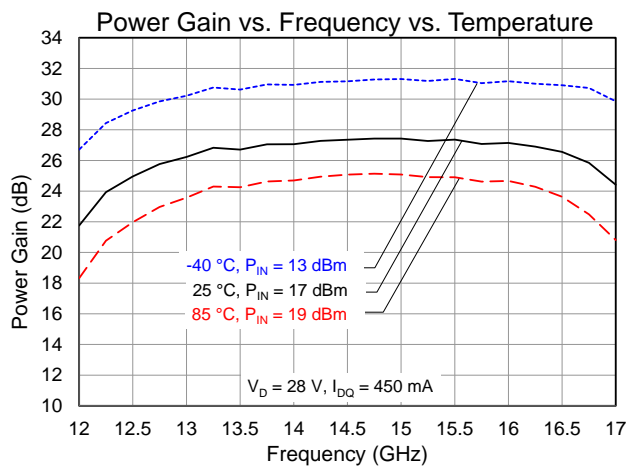
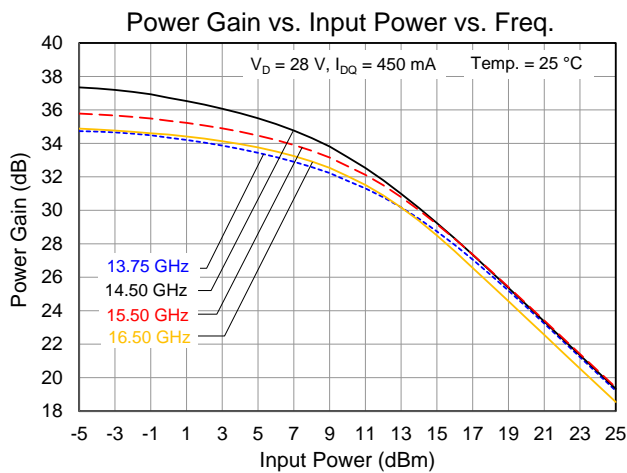
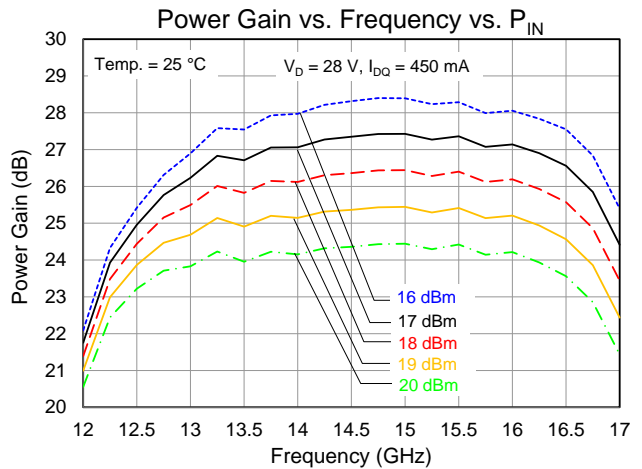
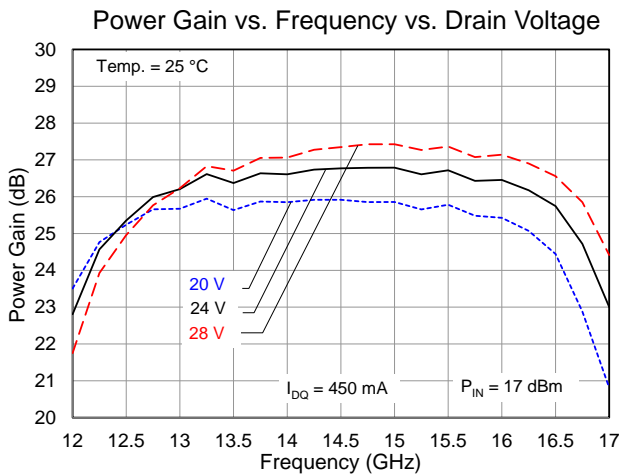
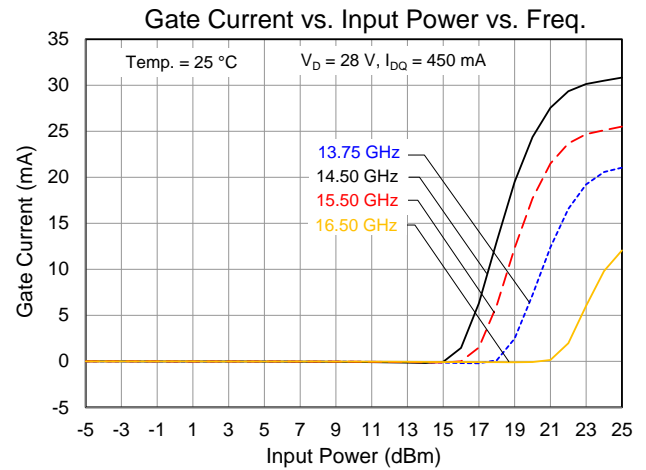
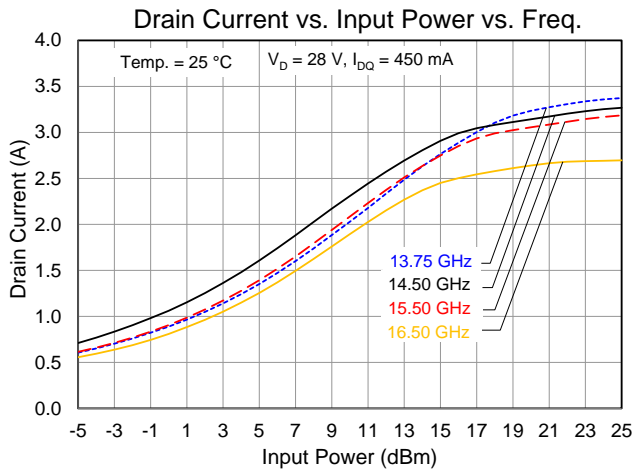

Typical Performance (Linearity)

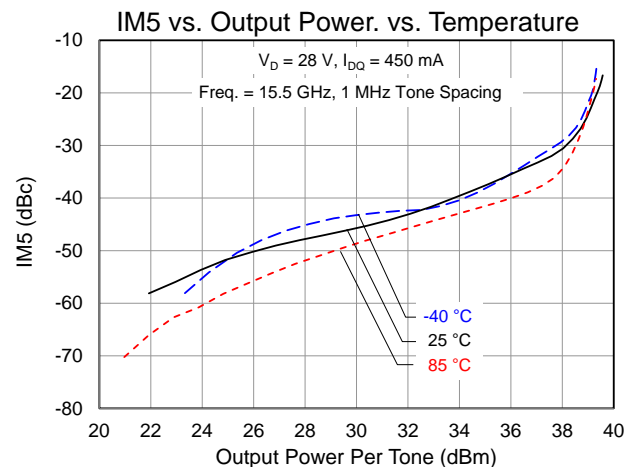
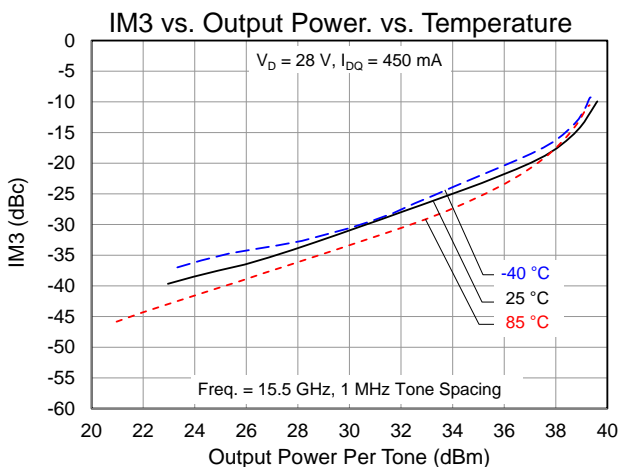
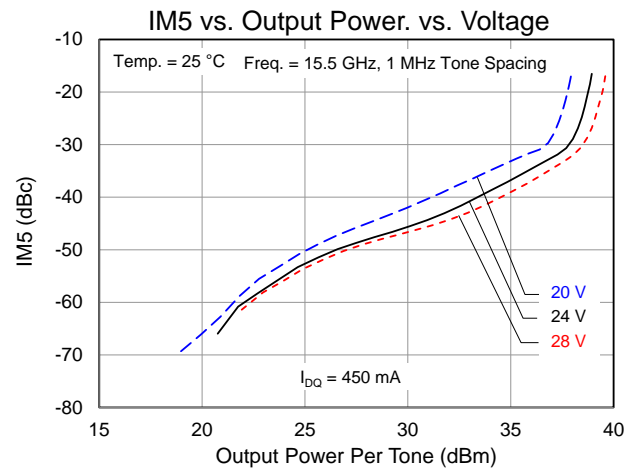
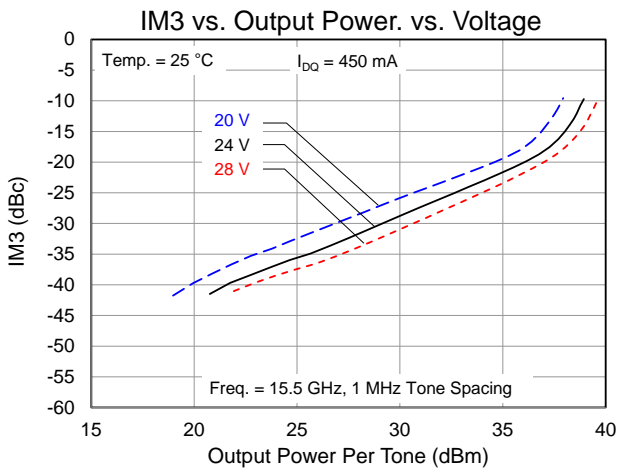
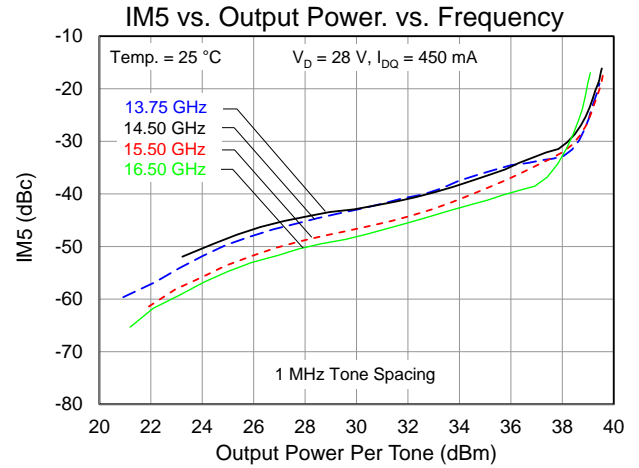
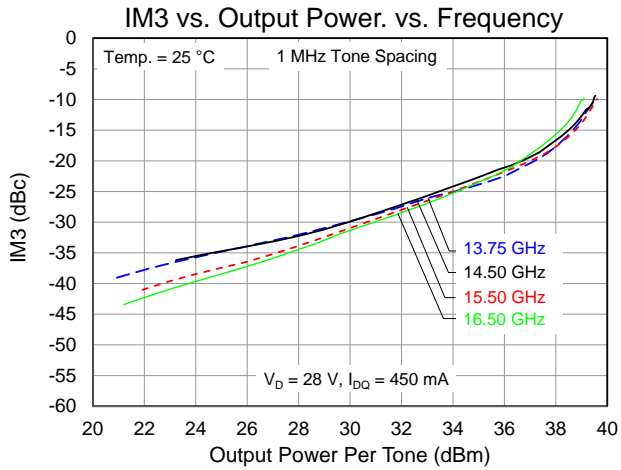

Typical Performance (Linearity)

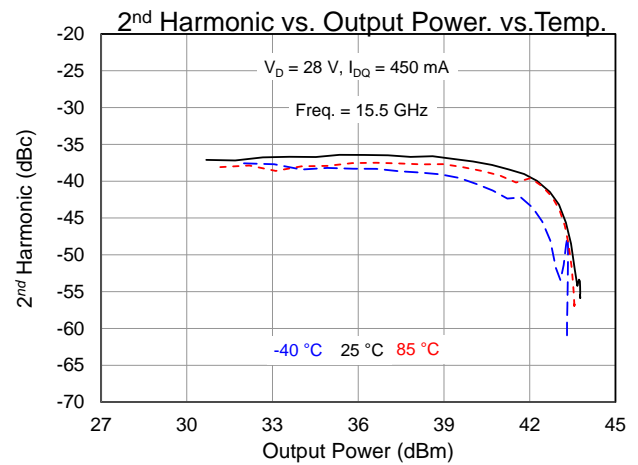
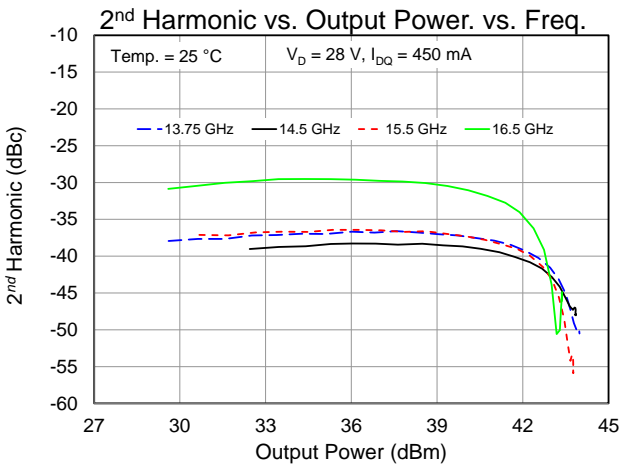
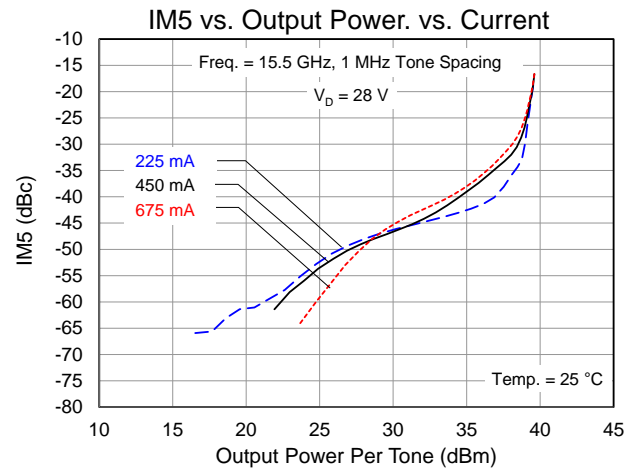
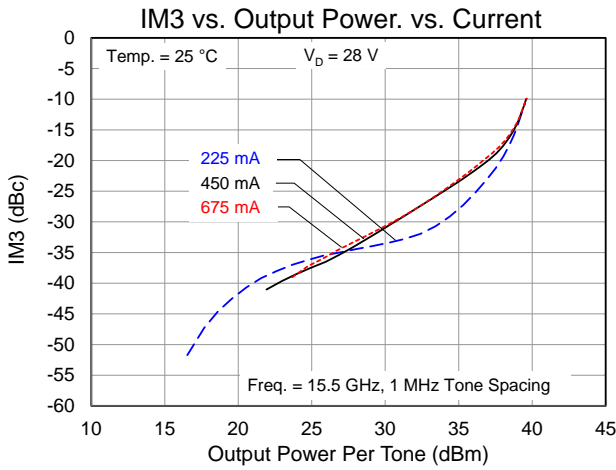

Application Circuit

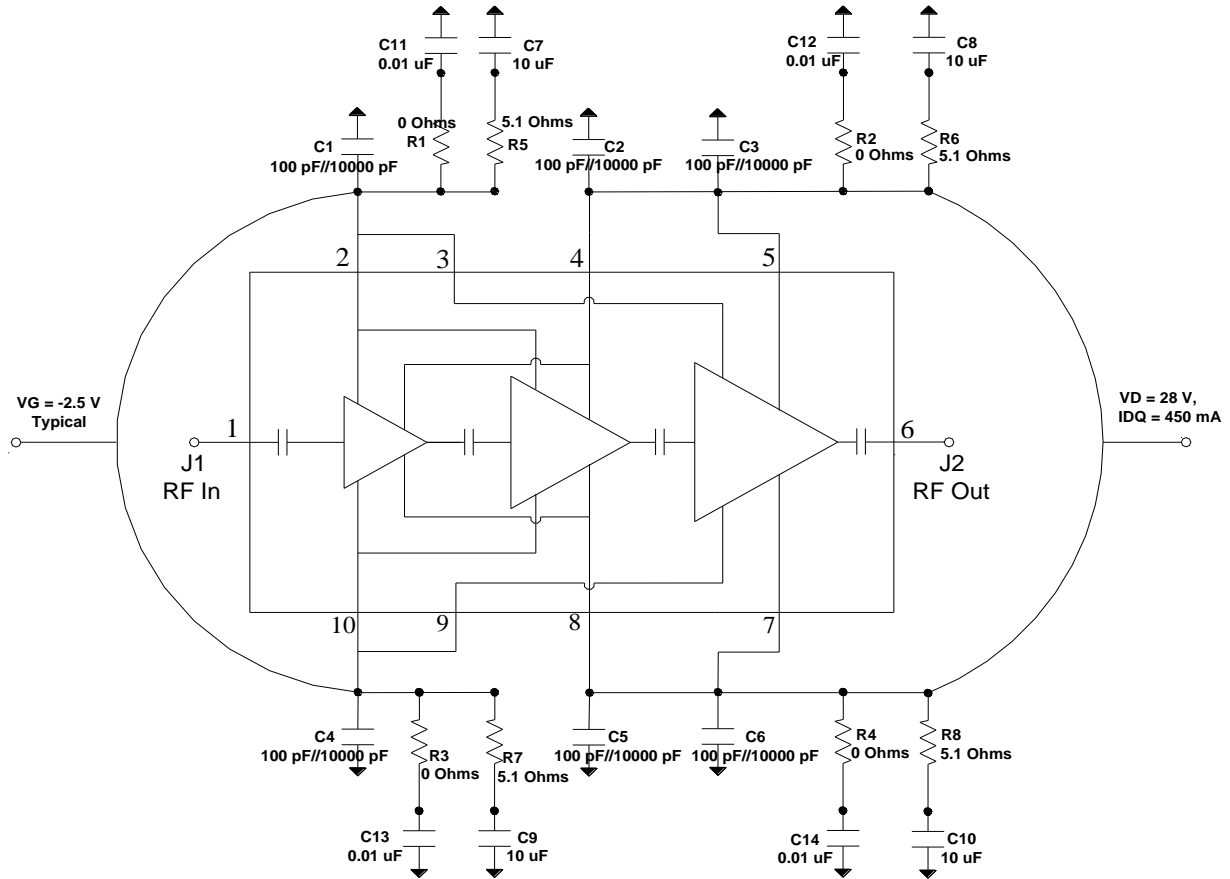

Notes:

V_G & V_D can be biased from either side of top or bottom.

Bias-up Procedure

1. Set I_D limit to 3.5 A, I_G limit to 50 mA
2. Set V_G to -5.0 V
3. Set V_D +28 V
4. Adjust V_G more positive until $I_{DQ} = 450$ mA ($V_G \sim -2.5$ V Typical)
5. Apply RF signal

Bias-down Procedure

1. Turn off RF signal
2. Reduce V_G to -5.0 V. Ensure $I_{DQ} \sim 0$ mA
3. Set V_D to 0 V
4. Turn off V_D supply
5. Turn off V_G supply

Evaluation Board (EVB) Layout Assembly

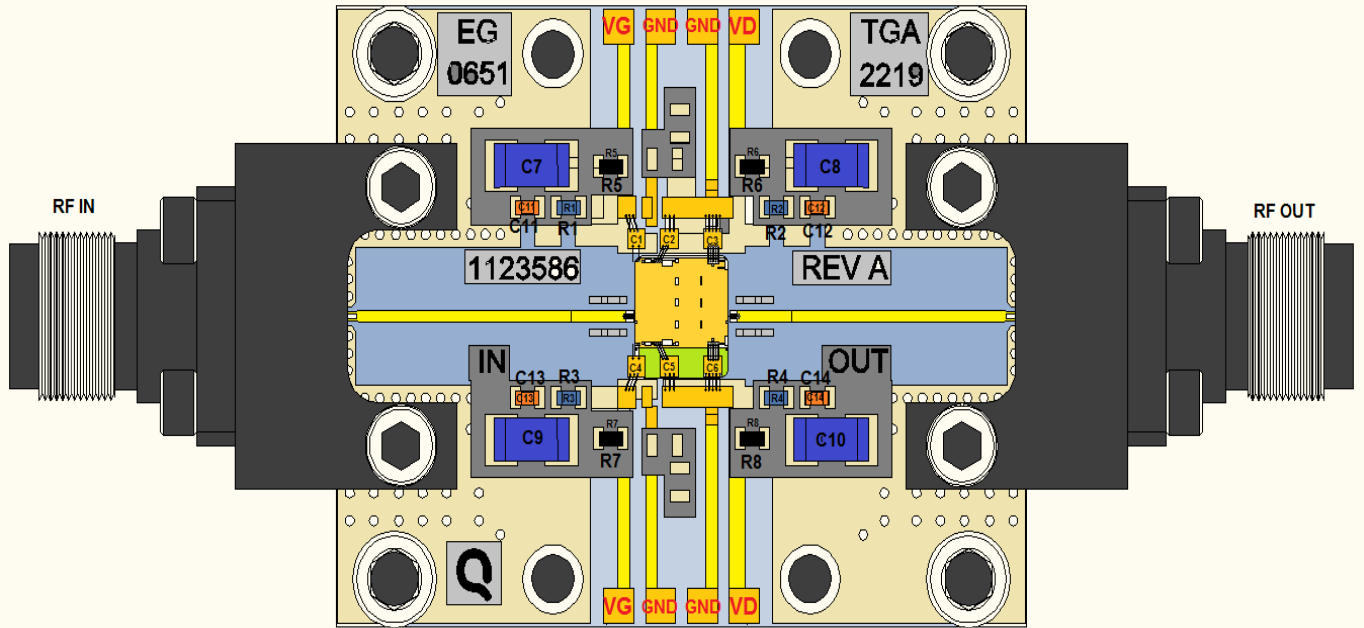

Notes: V_G & V_D can be biased from either side of top or bottom.

Bill of Materials

Reference Design	Value	Description	Manufacturer	Part Number
C1 – C6	100 pF 10000 pF	SLC, 50V	Various	
C7 – C10	10 uF	Cap, 1206, 50V, 20%, X5R	Various	
C11 – C14	0.01uF	Cap, 0402, 50V, 10%, X7R	Various	
R1 – R4	0 Ω	Res, 0402, 5%, SMD	Various	
R5 – R8	5.1 Ω	Res, 0402, 5%, 50 V, SMT	Various	

Mechanical Drawing & Bond Pad Description

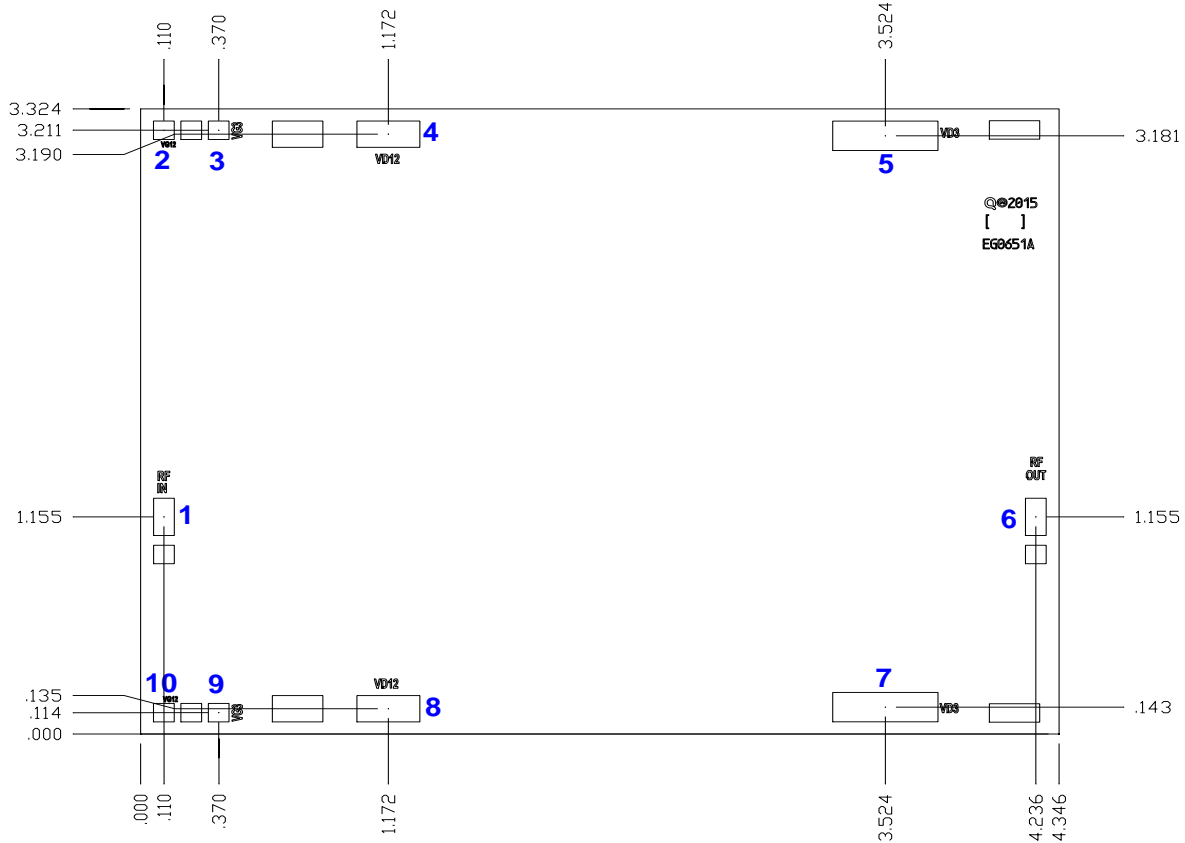

Unit: millimeters
 Thickness: 0.10
 Die x, y size tolerance: +/- 0.050
 Chip edge to bond pad dimensions are shown to center of pad
 Ground is backside of die

Bond Pad	Symbol	Pad Size	Description
1	RF In	0.098 x 0.198	RF Input; matched to 50Ω; DC Blocked
2, 10	V _{G12}	0.098 x 0.098	Gate voltage 1-2, bias network is required; see Application Circuit on page 11 as an example.
3, 9	V _{G3}	0.098 x 0.098	Gate voltage 3, bias network is required; see Application Circuit on page 11 as an example.
4, 8	V _{D12}	0.298 x 0.140	Drain voltage 1-2, bias network is required; see Application Circuit on page 11 as an example.
5, 7	V _{D3}	0.498 x 0.156	Drain voltage 3, bias network is required; see Application Circuit on page 11 as an example.
6	RF Out	0.098 x 0.198	RF Output; matched to 50Ω; DC Blocked .

Assembly Notes

Component placement and adhesive attachment assembly notes:

- Vacuum pencils and/or vacuum collets are the preferred method of pick up.
- Air bridges must be avoided during placement.
- The force impact is critical during auto placement.
- Organic attachment (i.e. epoxy) can be used in low-power applications.
- Curing should be done in a convection oven; proper exhaust is a safety concern.

Reflow process assembly notes:

- Use AuSn (80/20) solder and limit exposure to temperatures above 300°C to 3-4 minutes, maximum.
- An alloy station or conveyor furnace with reducing atmosphere should be used.
- Do not use any kind of flux.
- Coefficient of thermal expansion matching is critical for long-term reliability.
- Devices must be stored in a dry nitrogen atmosphere.

Interconnect process assembly notes:

- Thermosonic ball bonding is the preferred interconnect technique.
- Force, time, and ultrasonic are critical parameters.
- Aluminum wire should not be used.
- Devices with small pad sizes should be bonded with 0.0007-inch wire.

Product Compliance Information

ESD Sensitivity Ratings



Caution! ESD-Sensitive Device

ESD Rating: TBD
Value: TBD
Test: Human Body Model (HBM)
Standard: JEDEC Standard JESD22-A114

ECCN

US Department of Commerce: 3A001.b.2.c

Solderability

Use only AuSn (80/20) solder and limit exposure to temperature above 300 °C to 3–4 minutes, maximum.

RoHS–Compliance

This part is compliant with EU 2002/95/EC RoHS directive (Restrictions on the Use of Certain Hazardous Substances in Electrical and Electronic Equipment).

This product also has the following attributes:

- Lead Free
- Halogen Free (Chlorine, Bromine)
- Antimony Free
- TBBP-A (C₁₅H₁₂Br₄O₂) Free
- PFOS Free
- SVHC Free

Contact Information

For the latest specifications, additional product information, worldwide sales and distribution locations, and information about TriQuint:

Web: www.triquint.com
Email: info-sales@triquint.com

Tel: +1.972.994.8465
Fax: +1.972.994.8504

For technical questions and application information: Email: info-products@triquint.com

Important Notice

The information contained herein is believed to be reliable. TriQuint makes no warranties regarding the information contained herein. TriQuint assumes no responsibility or liability whatsoever for any of the information contained herein. TriQuint assumes no responsibility or liability whatsoever for the use of the information contained herein. The information contained herein is provided "AS IS, WHERE IS" and with all faults, and the entire risk associated with such information is entirely with the user. All information contained herein is subject to change without notice. Customers should obtain and verify the latest relevant information before placing orders for TriQuint products. The information contained herein or any use of such information does not grant, explicitly or implicitly, to any party any patent rights, licenses, or any other intellectual property rights, whether with regard to such information itself or anything described by such information.

TriQuint products are not warranted or authorized for use as critical components in medical, life-saving, or life-sustaining applications, or other applications where a failure would reasonably be expected to cause severe personal injury or death.

Компания «Океан Электроники» предлагает заключение долгосрочных отношений при поставках импортных электронных компонентов на взаимовыгодных условиях!

Наши преимущества:

- Поставка оригинальных импортных электронных компонентов напрямую с производств Америки, Европы и Азии, а так же с крупнейших складов мира;
- Широкая линейка поставок активных и пассивных импортных электронных компонентов (более 30 млн. наименований);
- Поставка сложных, дефицитных, либо снятых с производства позиций;
- Оперативные сроки поставки под заказ (от 5 рабочих дней);
- Экспресс доставка в любую точку России;
- Помощь Конструкторского Отдела и консультации квалифицированных инженеров;
- Техническая поддержка проекта, помощь в подборе аналогов, поставка прототипов;
- Поставка электронных компонентов под контролем ВП;
- Система менеджмента качества сертифицирована по Международному стандарту ISO 9001;
- При необходимости вся продукция военного и аэрокосмического назначения проходит испытания и сертификацию в лаборатории (по согласованию с заказчиком);
- Поставка специализированных компонентов военного и аэрокосмического уровня качества (Xilinx, Altera, Analog Devices, Intersil, Interpoint, Microsemi, Actel, Aeroflex, Peregrine, VPT, Syfer, Eurofarad, Texas Instruments, MS Kennedy, Miteq, Cobham, E2V, MA-COM, Hittite, Mini-Circuits, General Dynamics и др.);

Компания «Океан Электроники» является официальным дистрибьютором и эксклюзивным представителем в России одного из крупнейших производителей разъемов военного и аэрокосмического назначения «JONHON», а так же официальным дистрибьютором и эксклюзивным представителем в России производителя высокотехнологичных и надежных решений для передачи СВЧ сигналов «FORSTAR».



JONHON

«JONHON» (основан в 1970 г.)

Разъемы специального, военного и аэрокосмического назначения:

(Применяются в военной, авиационной, аэрокосмической, морской, железнодорожной, горно- и нефтедобывающей отраслях промышленности)

«FORSTAR» (основан в 1998 г.)

ВЧ соединители, коаксиальные кабели, кабельные сборки и микроволновые компоненты:

(Применяются в телекоммуникациях гражданского и специального назначения, в средствах связи, РЛС, а так же военной, авиационной и аэрокосмической отраслях промышленности).



Телефон: 8 (812) 309-75-97 (многоканальный)

Факс: 8 (812) 320-03-32

Электронная почта: ocean@oceanchips.ru

Web: <http://oceanchips.ru/>

Адрес: 198099, г. Санкт-Петербург, ул. Калинина, д. 2, корп. 4, лит. А