

# 3M™ Pak 5 Plug

0.5 mm Straight SMT Plug

PK5 Series

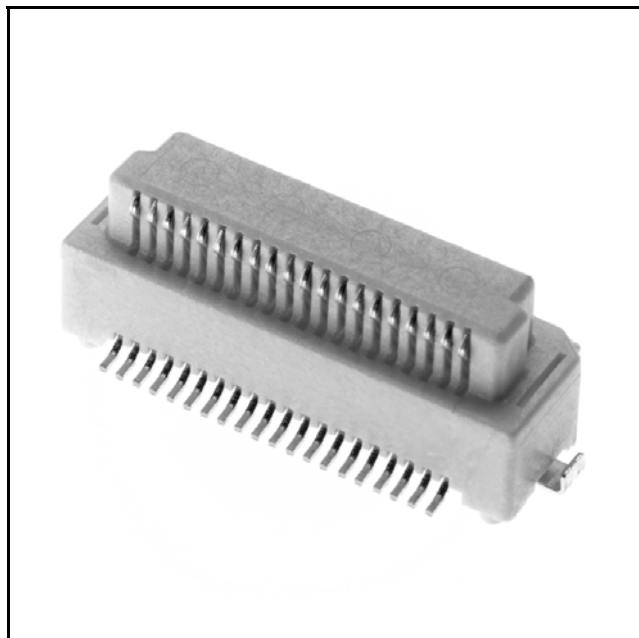

- 0.5 mm pitch high density plug conserves board space
- Mated heights available from 4 to 8 mm
- Surface mount design allows for easy inspection and repair of solder tails
- Tape and reel packaging available
- RoHS\* compliant

Date Modified: July 25, 2006

TS-1153-02  
Sheet 1 of 4

## Physical

### Insulation

Material: Glass filled LCP  
Flammability: UL 94V-0  
Color: White

### Contact

Material: Copper Alloy

### Plating

Underplating: Nickel  
Wiping Area:  $2 \mu\text{m}$  [  $0.05 \mu\text{m}$  ] min. Gold over Nickel  
Solder Tails: Gold over Nickel

## Electrical

**Current Rating:** 0.3 A

**Insulation Resistance:**  $10^3 \text{ M}\Omega$  min at 250 VDC

**Withstanding Voltage:** 200 VAC for 1 minute

## Environmental

**Temperature Rating:**  $-55^\circ\text{C}$  to  $+85^\circ\text{C}$

**Process Rating:**  $260^\circ\text{C}$  (per J-STD-020C)

\* RoHS = Directive 2002/95/EC, Restriction of the Use of Certain Hazardous Substances in Electrical and Electronic Equipment  
"RoHS compliant" means that the product or part does not contain any of the following substances in excess of the following maximum concentration values in any homogeneous material, unless the substance is in an application that is exempt under RoHS: (a) 0.1% (by weight) for lead, mercury, hexavalent chromium, polybrominated biphenyls or polybrominated diphenyl ethers; or (b) 0.01% (by weight) for cadmium. Unless otherwise stated by 3M in writing, this information represents 3M's knowledge and belief based upon information provided by third party suppliers to 3M.



Interconnect Solutions

<http://www.3M.com/interconnects/>

3M is a trademark of 3M Company.  
For technical, sales or ordering information call

800-225-5373

# 3M™ Pak 5 Plug

0.5 mm Straight SMT Plug

PK5 Series

Plug for 4, 5, 6 mm stacked height.

Product Table / Dimensions

Contact Quantity	A	B	C	D	E	F	G	H
40	9.50 [0.374]	10.62 [0.418]	11.52 [0.454]	13.22 [0.520]	10.50 [0.413]	11.76 [0.463]	14.54 [0.572]	13.59 [0.535]
50	12.00 [0.472]	13.12 [0.517]	14.02 [0.552]	15.72 [0.619]	13.00 [0.512]	14.26 [0.561]	17.04 [0.671]	16.09 [0.633]
60	14.50 [0.571]	15.62 [0.615]	16.52 [0.650]	18.22 [0.717]	15.50 [0.610]	16.76 [0.660]	19.54 [0.769]	18.59 [0.732]
80	19.50 [0.768]	20.62 [0.812]	21.52 [0.847]	23.22 [0.914]	20.50 [0.807]	21.76 [0.857]	24.54 [0.966]	23.59 [0.929]
100	24.50 [0.965]	25.62 [1.009]	26.52 [1.044]	28.22 [1.111]	25.50 [1.004]	26.76 [1.054]	29.54 [1.163]	28.59 [1.126]
120	29.50 [1.161]	30.62 [1.206]	31.52 [1.241]	33.22 [1.308]	30.50 [1.201]	31.76 [1.250]	34.54 [1.360]	33.59 [1.322]
140	34.50 [1.358]	35.62 [1.402]	36.52 [1.438]	38.22 [1.505]	35.50 [1.398]	36.76 [1.447]	39.54 [1.557]	38.59 [1.519]
160	39.50 [1.555]	40.62 [1.599]	41.52 [1.635]	43.22 [1.702]	40.50 [1.594]	41.76 [1.644]	44.54 [1.754]	43.59 [1.716]

X-X' Cross Section

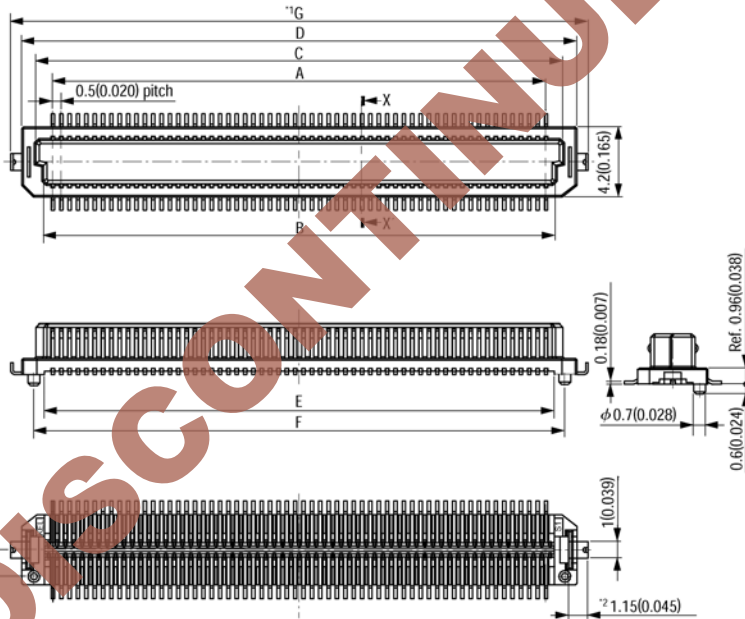
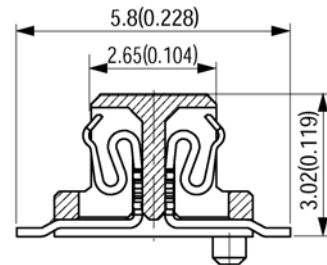

Printed Circuit Board Layout (Component Side View)

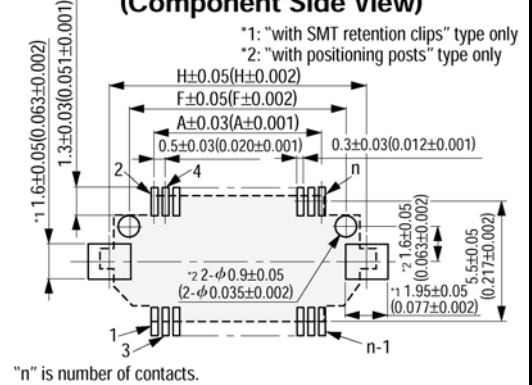

TS-1153-02  
Sheet 2 of 4

# 3M™ Pak 5 Plug

0.5 mm Straight SMT Plug

PK5 Series

Plug for 6, 7, 8 mm stacked height.

Product Table / Dimensions

Contact Quantity	A	B	C	D	E	F	G	H
40	9.50	10.62	11.52	13.22	10.50	11.76	14.54	13.59
	[0.374]	[0.418]	[0.454]	[0.520]	[0.413]	[0.463]	[0.572]	[0.535]
50	12.00	13.12	14.02	15.72	13.00	14.26	17.04	16.09
	[0.472]	[0.517]	[0.552]	[0.619]	[0.512]	[0.561]	[0.671]	[0.633]
60	14.50	15.62	16.52	18.22	15.50	16.76	19.54	18.59
	[0.571]	[0.615]	[0.650]	[0.717]	[0.610]	[0.660]	[0.769]	[0.732]
80	19.50	20.62	21.52	23.22	20.50	21.76	24.54	23.59
	[0.768]	[0.812]	[0.847]	[0.914]	[0.807]	[0.857]	[0.966]	[0.929]
100	24.50	25.62	26.52	28.22	25.50	26.76	29.54	28.59
	[0.965]	[1.009]	[1.044]	[1.111]	[1.004]	[1.054]	[1.163]	[1.126]
120	29.50	30.62	31.52	33.22	30.50	31.76	34.54	33.59
	[1.161]	[1.206]	[1.241]	[1.308]	[1.201]	[1.250]	[1.360]	[1.322]
140	34.50	35.62	36.52	38.22	35.50	36.76	39.54	38.59
	[1.358]	[1.402]	[1.438]	[1.505]	[1.398]	[1.447]	[1.557]	[1.519]
160	39.50	40.62	41.52	43.22	40.50	41.76	44.54	43.59
	[1.555]	[1.599]	[1.635]	[1.702]	[1.594]	[1.644]	[1.754]	[1.716]

X-X' Cross Section

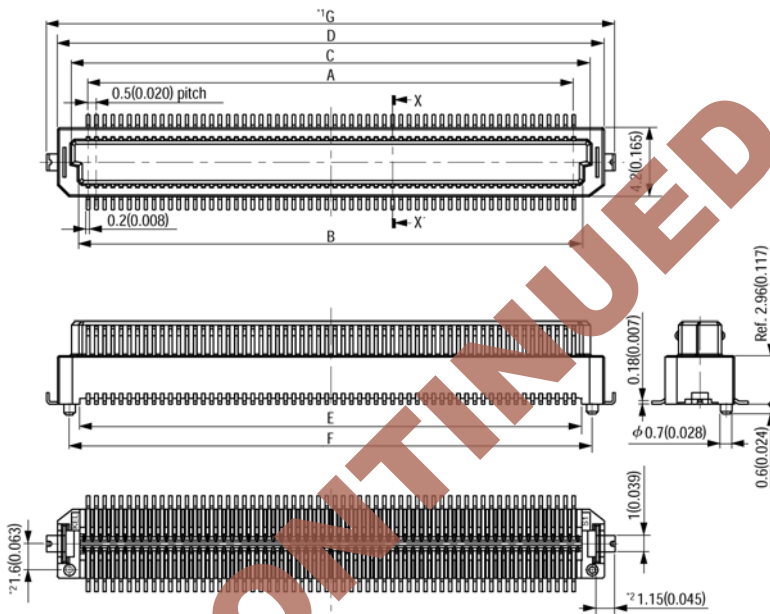
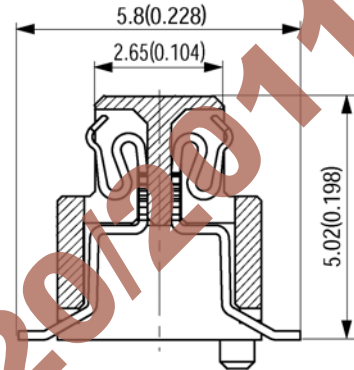

Printed Circuit Board Layout (Component Side View)

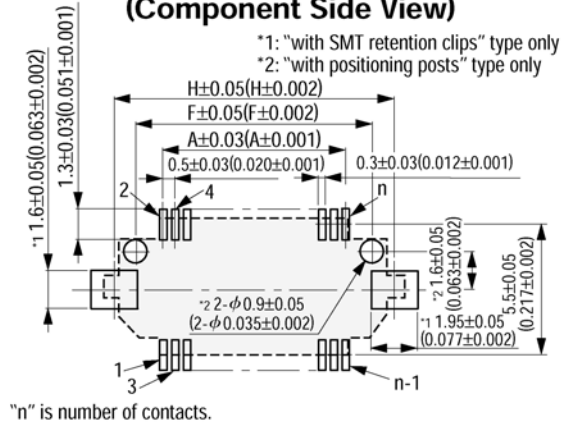

TS-1153-02  
 Sheet 3 of 4

# 3M™ Pak 5 Plug

0.5 mm Straight SMT Plug

PK5 Series

## STACKED MATING COMBINATIONS

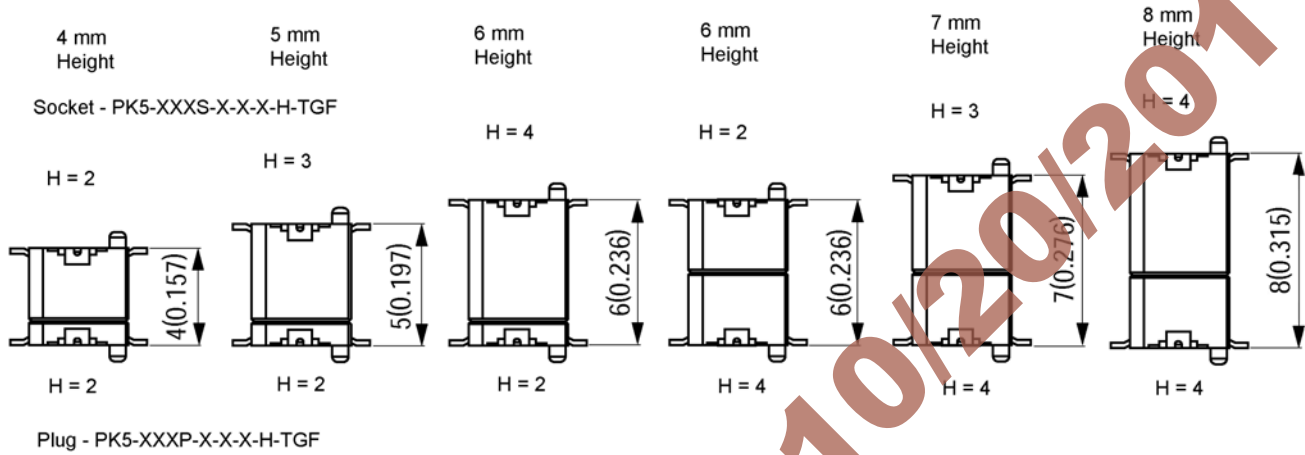

## Ordering Information

PK5 - XXXP - X - X - X - X - GGF

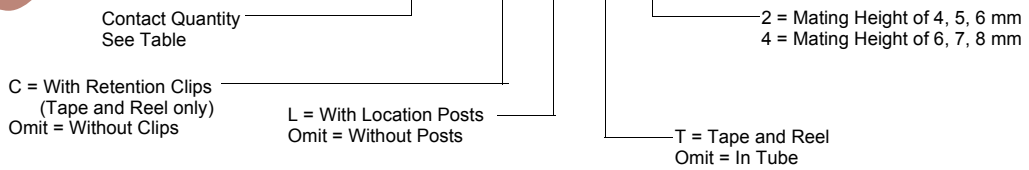

TS-1153-02  
Sheet 4 of 4



Interconnect Solutions

<http://www.3M.com/interconnects/>

3M is a trademark of 3M Company.  
For technical, sales or ordering information call  
800-225-5373

3M CONTINUED 10/20/2011

### Important Notice

All statements, technical information, and recommendations related to 3M's products are based on information believed to be reliable, but the accuracy or completeness is not guaranteed. Before using this product, you must evaluate it and determine if it is suitable for your intended application. You assume all risks and liability associated with such use. Any statements related to the product which are not contained in 3M's current publications, or any contrary statements contained on your purchase order shall have no force or effect unless expressly agreed upon, in writing, by an authorized officer of 3M.



### 3M Electronics

6801 River Place Blvd.  
Austin, TX 78726-9000  
800/225-5373  
[www.3M.com/electronics](http://www.3M.com/electronics)

### Warranty; Limited Remedy; Limited Liability.

This product will be free from defects in material and manufacture for a period of one (1) year from the time of purchase. **3M MAKES NO OTHER WARRANTIES INCLUDING, BUT NOT LIMITED TO, ANY IMPLIED WARRANTY OF MERCHANTABILITY OR FITNESS FOR A PARTICULAR PURPOSE.** If this product is defective within the warranty period stated above, your exclusive remedy shall be, at 3M's option, to replace or repair the 3M product or refund the purchase price of the 3M product. **Except where prohibited by law, 3M will not be liable for any indirect, special, incidental or consequential loss or damage arising from this 3M product, regardless of the legal theory asserted.**



Minimum 10%  
Post-Consumer Fiber

Printed in USA.

© 3M 2006

Компания «Океан Электроники» предлагает заключение долгосрочных отношений при поставках импортных электронных компонентов на взаимовыгодных условиях!

Наши преимущества:

- Поставка оригинальных импортных электронных компонентов напрямую с производств Америки, Европы и Азии, а так же с крупнейших складов мира;
- Широкая линейка поставок активных и пассивных импортных электронных компонентов (более 30 млн. наименований);
- Поставка сложных, дефицитных, либо снятых с производства позиций;
- Оперативные сроки поставки под заказ (от 5 рабочих дней);
- Экспресс доставка в любую точку России;
- Помощь Конструкторского Отдела и консультации квалифицированных инженеров;
- Техническая поддержка проекта, помощь в подборе аналогов, поставка прототипов;
- Поставка электронных компонентов под контролем ВП;
- Система менеджмента качества сертифицирована по Международному стандарту ISO 9001;
- При необходимости вся продукция военного и аэрокосмического назначения проходит испытания и сертификацию в лаборатории (по согласованию с заказчиком);
- Поставка специализированных компонентов военного и аэрокосмического уровня качества (Xilinx, Altera, Analog Devices, Intersil, Interpoint, Microsemi, Actel, Aeroflex, Peregrine, VPT, Syfer, Eurofarad, Texas Instruments, MS Kennedy, Miteq, Cobham, E2V, MA-COM, Hittite, Mini-Circuits, General Dynamics и др.);

Компания «Океан Электроники» является официальным дистрибьютором и эксклюзивным представителем в России одного из крупнейших производителей разъемов военного и аэрокосмического назначения «JONHON», а так же официальным дистрибьютором и эксклюзивным представителем в России производителя высокотехнологичных и надежных решений для передачи СВЧ сигналов «FORSTAR».



## JONHON

«JONHON» (основан в 1970 г.)

Разъемы специального, военного и аэрокосмического назначения:

(Применяются в военной, авиационной, аэрокосмической, морской, железнодорожной, горно- и нефтедобывающей отраслях промышленности)

«FORSTAR» (основан в 1998 г.)

ВЧ соединители, коаксиальные кабели,  
кабельные сборки и микроволновые компоненты:

(Применяются в телекоммуникациях гражданского и специального назначения, в средствах связи, РЛС, а так же военной, авиационной и аэрокосмической отраслях промышленности).



Телефон: 8 (812) 309-75-97 (многоканальный)

Факс: 8 (812) 320-03-32

Электронная почта: [ocean@oceanchips.ru](mailto:ocean@oceanchips.ru)

Web: <http://oceanchips.ru/>

Адрес: 198099, г. Санкт-Петербург, ул. Калинина, д. 2, корп. 4, лит. А