



CY7C1470BV33
 CY7C1472BV33
 CY7C1474BV33

72-Mbit (2M × 36/4M × 18/1M × 72) Pipelined SRAM with NoBL™ Architecture

Features

- Pin-compatible and functionally equivalent to ZBT™
- Supports 250 MHz bus operations with zero wait states
 - Available speed grades are 250, 200, and 167 MHz
- Internally self timed output buffer control to eliminate the need to use asynchronous OE
- Fully registered (inputs and outputs) for pipelined operation
- Byte Write capability
- Single 3.3 V power supply
- 3.3 V/2.5 V I/O power supply
- Fast clock-to-output time
 - 3.0 ns (for 250 MHz device)
- Clock Enable ($\overline{\text{CEN}}$) pin to suspend operation
- Synchronous self timed writes
- CY7C1470BV33, CY7C1472BV33 available in JEDEC-standard Pb-free 100-pin TQFP, Pb-free and non-Pb-free 165-ball FBGA package. CY7C1474BV33 available in Pb-free and non-Pb-free 209-ball FBGA package
- IEEE 1149.1 JTAG Boundary Scan compatible
- Burst capability – linear or interleaved burst order
- “ZZ” Sleep Mode option and Stop Clock option

Functional Description

The CY7C1470BV33, CY7C1472BV33, and CY7C1474BV33 are 3.3 V, 2M × 36/4M × 18/1M × 72 Synchronous pipelined burst SRAMs with No Bus Latency™ (NoBL™) logic, respectively. They are designed to support unlimited true back-to-back read or write operations with no wait states. The CY7C1470BV33, CY7C1472BV33, and CY7C1474BV33 are equipped with the advanced (NoBL) logic required to enable consecutive read or write operations with data being transferred on every clock cycle. This feature dramatically improves the throughput of data in systems that require frequent read or write transitions. The CY7C1470BV33, CY7C1472BV33, and CY7C1474BV33 are pin compatible and functionally equivalent to ZBT devices.

All synchronous inputs pass through input registers controlled by the rising edge of the clock. All data outputs pass through output registers controlled by the rising edge of the clock. The clock input is qualified by the Clock Enable ($\overline{\text{CEN}}$) signal, which when deasserted suspends operation and extends the previous clock cycle.

Write operations are controlled by the Byte Write Selects ($\text{BW}_a\text{--}\text{BW}_d$ for CY7C1470BV33, $\text{BW}_a\text{--}\text{BW}_b$ for CY7C1472BV33, and $\text{BW}_a\text{--}\text{BW}_h$ for CY7C1474BV33) and a Write Enable ($\overline{\text{WE}}$) input. All writes are conducted with on-chip synchronous self timed write circuitry.

Three synchronous Chip Enables ($\overline{\text{CE}}_1$, CE_2 , $\overline{\text{CE}}_3$) and an asynchronous Output Enable ($\overline{\text{OE}}$) provide for easy bank selection and output tri-state control. To avoid bus contention, the output drivers are synchronously tri-stated during the data portion of a write sequence.

For a complete list of related documentation, click [here](#).

Selection Guide

Description	250 MHz	200 MHz	167 MHz	Unit
Maximum Access Time	3.0	3.0	3.4	ns
Maximum Operating Current	500	500	450	mA
Maximum CMOS Standby Current	120	120	120	mA

Logic Block Diagram – CY7C1470BV33



Logic Block Diagram – CY7C1472BV33





Logic Block Diagram – CY7C1474BV33

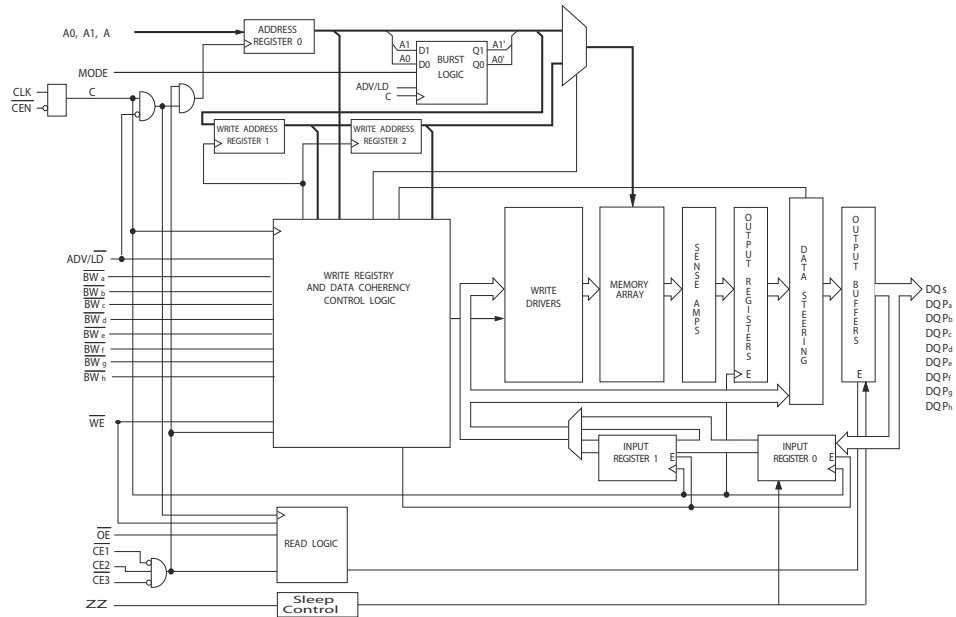



Contents

Pin Configurations	5	Identification Register Definitions	20
Pin Definitions	8	Scan Register Sizes	20
Functional Overview	9	Identification Codes	20
Single Read Accesses	9	Boundary Scan Exit Order	21
Burst Read Accesses	9	Boundary Scan Exit Order	21
Single Write Accesses	9	Boundary Scan Exit Order	22
Burst Write Accesses	10	Maximum Ratings	23
Sleep Mode	10	Operating Range	23
Interleaved Burst Address Table	10	Neutron Soft Error Immunity	23
Linear Burst Address Table	10	Electrical Characteristics	23
ZZ Mode Electrical Characteristics	10	Capacitance	25
Truth Table	11	Thermal Resistance	25
Partial Write Cycle Description	12	AC Test Loads and Waveforms	25
IEEE 1149.1 Serial Boundary Scan (JTAG)	13	Switching Characteristics	26
Disabling the JTAG Feature	13	Switching Waveforms	27
Test Access Port (TAP)	13	Ordering Information	29
PERFORMING A TAP RESET	13	Ordering Code Definitions	29
TAP REGISTERS	13	Package Diagrams	30
TAP Instruction Set	14	Acronyms	33
TAP Controller State Diagram	15	Document Conventions	33
TAP Controller Block Diagram	16	Units of Measure	33
TAP Timing	17	Document History Page	34
TAP AC Switching Characteristics	18	Sales, Solutions, and Legal Information	35
3.3 V TAP AC Test Conditions	19	Worldwide Sales and Design Support	35
3.3 V TAP AC Output Load Equivalent	19	Products	35
2.5 V TAP AC Test Conditions	19	PSoC® Solutions	35
2.5 V TAP AC Output Load Equivalent	19	Cypress Developer Community	35
TAP DC Electrical Characteristics		Technical Support	35
and Operating Conditions	19		



Pin Configurations

Figure 1. 100-pin TQFP (14 × 20 × 1.4 mm) pinout

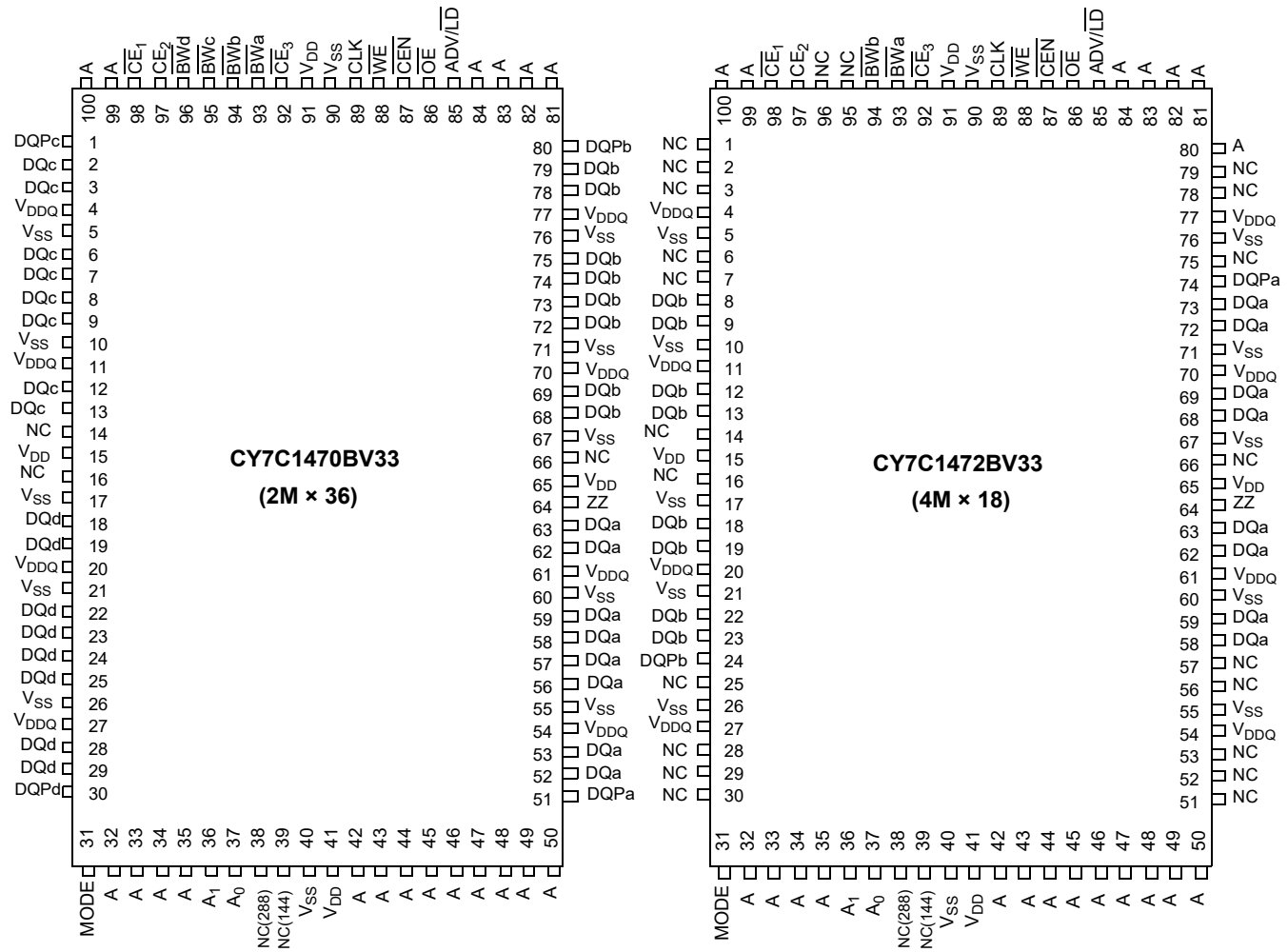



Pin Configurations (continued)

Figure 2. 165-ball FBGA (15 × 17 × 1.4 mm) pinout

CY7C1470BV33 (2M × 36)

	1	2	3	4	5	6	7	8	9	10	11
A	NC/576M	A	\overline{CE}_1	\overline{BW}_c	\overline{BW}_b	\overline{CE}_3	\overline{CEN}	ADV/LD	A	A	NC
B	NC/1G	A	CE2	\overline{BW}_d	\overline{BW}_a	CLK	\overline{WE}	\overline{OE}	A	A	NC
C	DQP _c	NC	V _{DDQ}	V _{SS}	V _{SS}	V _{SS}	V _{SS}	V _{SS}	V _{DDQ}	NC	DQP _b
D	DQ _c	DQ _c	V _{DDQ}	V _{DD}	V _{SS}	V _{SS}	V _{SS}	V _{DD}	V _{DDQ}	DQ _b	DQ _b
E	DQ _c	DQ _c	V _{DDQ}	V _{DD}	V _{SS}	V _{SS}	V _{SS}	V _{DD}	V _{DDQ}	DQ _b	DQ _b
F	DQ _c	DQ _c	V _{DDQ}	V _{DD}	V _{SS}	V _{SS}	V _{SS}	V _{DD}	V _{DDQ}	DQ _b	DQ _b
G	DQ _c	DQ _c	V _{DDQ}	V _{DD}	V _{SS}	V _{SS}	V _{SS}	V _{DD}	V _{DDQ}	DQ _b	DQ _b
H	NC	NC	NC	V _{DD}	V _{SS}	V _{SS}	V _{SS}	V _{DD}	NC	NC	ZZ
J	DQ _d	DQ _d	V _{DDQ}	V _{DD}	V _{SS}	V _{SS}	V _{SS}	V _{DD}	V _{DDQ}	DQ _a	DQ _a
K	DQ _d	DQ _d	V _{DDQ}	V _{DD}	V _{SS}	V _{SS}	V _{SS}	V _{DD}	V _{DDQ}	DQ _a	DQ _a
L	DQ _d	DQ _d	V _{DDQ}	V _{DD}	V _{SS}	V _{SS}	V _{SS}	V _{DD}	V _{DDQ}	DQ _a	DQ _a
M	DQ _d	DQ _d	V _{DDQ}	V _{DD}	V _{SS}	V _{SS}	V _{SS}	V _{DD}	V _{DDQ}	DQ _a	DQ _a
N	DQP _d	NC	V _{DDQ}	V _{SS}	NC	NC	NC	V _{SS}	V _{DDQ}	NC	DQP _a
P	NC/144M	A	A	A	TDI	A1	TDO	A	A	A	NC/288M
R	MODE	A	A	A	TMS	A0	TCK	A	A	A	A

CY7C1472BV33 (4M × 18)

	1	2	3	4	5	6	7	8	9	10	11
A	NC/576M	A	\overline{CE}_1	\overline{BW}_b	NC	\overline{CE}_3	\overline{CEN}	ADV/LD	A	A	A
B	NC/1G	A	CE2	NC	\overline{BW}_a	CLK	\overline{WE}	\overline{OE}	A	A	NC
C	NC	NC	V _{DDQ}	V _{SS}	V _{SS}	V _{SS}	V _{SS}	V _{SS}	V _{DDQ}	NC	DQP _a
D	NC	DQ _b	V _{DDQ}	V _{DD}	V _{SS}	V _{SS}	V _{SS}	V _{DD}	V _{DDQ}	NC	DQ _a
E	NC	DQ _b	V _{DDQ}	V _{DD}	V _{SS}	V _{SS}	V _{SS}	V _{DD}	V _{DDQ}	NC	DQ _a
F	NC	DQ _b	V _{DDQ}	V _{DD}	V _{SS}	V _{SS}	V _{SS}	V _{DD}	V _{DDQ}	NC	DQ _a
G	NC	DQ _b	V _{DDQ}	V _{DD}	V _{SS}	V _{SS}	V _{SS}	V _{DD}	V _{DDQ}	NC	DQ _a
H	NC	NC	NC	V _{DD}	V _{SS}	V _{SS}	V _{SS}	V _{DD}	NC	NC	ZZ
J	DQ _b	NC	V _{DDQ}	V _{DD}	V _{SS}	V _{SS}	V _{SS}	V _{DD}	V _{DDQ}	DQ _a	NC
K	DQ _b	NC	V _{DDQ}	V _{DD}	V _{SS}	V _{SS}	V _{SS}	V _{DD}	V _{DDQ}	DQ _a	NC
L	DQ _b	NC	V _{DDQ}	V _{DD}	V _{SS}	V _{SS}	V _{SS}	V _{DD}	V _{DDQ}	DQ _a	NC
M	DQ _b	NC	V _{DDQ}	V _{DD}	V _{SS}	V _{SS}	V _{SS}	V _{DD}	V _{DDQ}	DQ _a	NC
N	DQP _b	NC	V _{DDQ}	V _{SS}	NC	NC	NC	V _{SS}	V _{DDQ}	NC	NC
P	NC/144M	A	A	A	TDI	A1	TDO	A	A	A	NC/288M
R	MODE	A	A	A	TMS	A0	TCK	A	A	A	A



Pin Configurations (continued)

Figure 3. 209-ball FBGA (14 × 22 × 1.76 mm) pinout

CY7C1474BV33 (1M × 72)

	1	2	3	4	5	6	7	8	9	10	11
A	DQg	DQg	A	CE ₂	A	ADV/LD	A	CE ₃	A	DQb	DQb
B	DQg	DQg	BWS _c	BWS _g	NC	WE	A	BWS _b	BWS _f	DQb	DQb
C	DQg	DQg	BWS _h	BWS _d	NC/576M	CE ₁	NC	BWS _e	BWS _a	DQb	DQb
D	DQg	DQg	V _{SS}	NC	NC/1G	OE	NC	NC	V _{SS}	DQb	DQb
E	DQPg	DQPc	V _{DDQ}	V _{DDQ}	V _{DD}	V _{DD}	V _{DD}	V _{DDQ}	V _{DDQ}	DQPf	DQPb
F	DQc	DQc	V _{SS}	V _{SS}	V _{SS}	NC	V _{SS}	V _{SS}	V _{SS}	DQf	DQf
G	DQc	DQc	V _{DDQ}	V _{DDQ}	V _{DD}	NC	V _{DD}	V _{DDQ}	V _{DDQ}	DQf	DQf
H	DQc	DQc	V _{SS}	V _{SS}	V _{SS}	NC	V _{SS}	V _{SS}	V _{SS}	DQf	DQf
J	DQc	DQc	V _{DDQ}	V _{DDQ}	V _{DD}	NC	V _{DD}	V _{DDQ}	V _{DDQ}	DQf	DQf
K	NC	NC	CLK	NC	V _{SS}	CEN	V _{SS}	NC	NC	NC	NC
L	DQh	DQh	V _{DDQ}	V _{DDQ}	V _{DD}	NC	V _{DD}	V _{DDQ}	V _{DDQ}	DQa	DQa
M	DQh	DQh	V _{SS}	V _{SS}	V _{SS}	NC	V _{SS}	V _{SS}	V _{SS}	DQa	DQa
N	DQh	DQh	V _{DDQ}	V _{DDQ}	V _{DD}	NC	V _{DD}	V _{DDQ}	V _{DDQ}	DQa	DQa
P	DQh	DQh	V _{SS}	V _{SS}	V _{SS}	ZZ	V _{SS}	V _{SS}	V _{SS}	DQa	DQa
R	DQPd	DQPd	V _{DDQ}	V _{DDQ}	V _{DD}	V _{DD}	V _{DD}	V _{DDQ}	V _{DDQ}	DQPd	DQPd
T	DQd	DQd	V _{SS}	NC	NC	MODE	NC	NC	V _{SS}	DQe	DQe
U	DQd	DQd	NC/144M	A	A	A	A	A	NC/288M	DQe	DQe
V	DQd	DQd	A	A	A	A1	A	A	A	DQe	DQe
W	DQd	DQd	TMS	TDI	A	A0	A	TDO	TCK	DQe	DQe



Pin Definitions

Pin Name	I/O Type	Pin Description
A ₀ , A ₁ , A	Input-Synchronous	Address Inputs Used to Select One of the Address Locations. Sampled at the rising edge of the CLK.
\overline{BW}_a , \overline{BW}_b , \overline{BW}_c , \overline{BW}_d , \overline{BW}_e , \overline{BW}_f , \overline{BW}_g , \overline{BW}_h	Input-Synchronous	Byte Write Select Inputs, Active LOW. Qualified with \overline{WE} to conduct writes to the SRAM. Sampled on the rising edge of CLK. \overline{BW}_a controls DQ _a and DQP _a , \overline{BW}_b controls DQ _b and DQP _b , \overline{BW}_c controls DQ _c and DQP _c , \overline{BW}_d controls DQ _d and DQP _d , \overline{BW}_e controls DQ _e and DQP _e , \overline{BW}_f controls DQ _f and DQP _f , \overline{BW}_g controls DQ _g and DQP _g , \overline{BW}_h controls DQ _h and DQP _h .
\overline{WE}	Input-Synchronous	Write Enable Input, Active LOW. Sampled on the rising edge of CLK if \overline{CEN} is active LOW. This signal must be asserted LOW to initiate a write sequence.
ADV/LD	Input-Synchronous	Advance/Load Input Used to Advance the On-chip Address Counter or Load a New Address. When HIGH (and \overline{CEN} is asserted LOW) the internal burst counter is advanced. When LOW, a new address can be loaded into the device for an access. After being deselected, ADV/LD must be driven LOW to load a new address.
CLK	Input-Clock	Clock Input. Used to capture all synchronous inputs to the device. CLK is qualified with \overline{CEN} . CLK is only recognized if \overline{CEN} is active LOW.
\overline{CE}_1	Input-Synchronous	Chip Enable 1 Input, Active LOW. Sampled on the rising edge of CLK. Used in conjunction with \overline{CE}_2 and \overline{CE}_3 to select or deselect the device.
\overline{CE}_2	Input-Synchronous	Chip Enable 2 Input, Active HIGH. Sampled on the rising edge of CLK. Used in conjunction with \overline{CE}_1 and \overline{CE}_3 to select or deselect the device.
\overline{CE}_3	Input-Synchronous	Chip Enable 3 Input, Active LOW. Sampled on the rising edge of CLK. Used in conjunction with \overline{CE}_1 and \overline{CE}_2 to select or deselect the device.
\overline{OE}	Input-Asynchronous	Output Enable, Active LOW. Combined with the synchronous logic block inside the device to control the direction of the I/O pins. When LOW, the I/O pins are enabled to behave as outputs. When deasserted HIGH, I/O pins are tri-stated, and act as input data pins. \overline{OE} is masked during the data portion of a write sequence, during the first clock when emerging from a deselected state and when the device has been deselected.
\overline{CEN}	Input-Synchronous	Clock Enable Input, Active LOW. When asserted LOW the clock signal is recognized by the SRAM. When deasserted HIGH the clock signal is masked. Since deasserting \overline{CEN} does not deselect the device, \overline{CEN} can be used to extend the previous cycle when required.
DQ _s	I/O-Synchronous	Bidirectional Data I/O Lines. As inputs, they feed into an on-chip data register that is triggered by the rising edge of CLK. As outputs, they deliver the data contained in the memory location specified by A _[17:0] during the previous clock rise of the read cycle. The direction of the pins is controlled by \overline{OE} and the internal control logic. When \overline{OE} is asserted LOW, the pins can behave as outputs. When HIGH, DQ _a –DQ _d are placed in a tri-state condition. The outputs are automatically tri-stated during the data portion of a write sequence, during the first clock when emerging from a deselected state, and when the device is deselected, regardless of the state of \overline{OE} .
DQP _x	I/O-Synchronous	Bidirectional Data Parity I/O Lines. Functionally, these signals are identical to DQ _x . During write sequences, DQP _a is controlled by \overline{BW}_a , DQP _b is controlled by \overline{BW}_b , DQP _c is controlled by \overline{BW}_c , and DQP _d is controlled by \overline{BW}_d , DQP _e is controlled by \overline{BW}_e , DQP _f is controlled by \overline{BW}_f , DQP _g is controlled by \overline{BW}_g , DQP _h is controlled by \overline{BW}_h .
MODE	Input Strap Pin	Mode Input. Selects the burst order of the device. Tied HIGH selects the interleaved burst order. Pulled LOW selects the linear burst order. MODE must not change states during operation. When left floating MODE defaults HIGH, to an interleaved burst order.
TDO	JTAG Serial Output Synchronous	Serial Data Out to the JTAG Circuit. Delivers data on the negative edge of TCK.
TDI	JTAG Serial Input Synchronous	Serial Data In to the JTAG Circuit. Sampled on the rising edge of TCK.



Pin Definitions (continued)

Pin Name	I/O Type	Pin Description
TMS	Test Mode Select Synchronous	This pin Controls the Test Access Port State Machine. Sampled on the rising edge of TCK.
TCK	JTAG Clock	Clock Input to the JTAG Circuitry.
V _{DD}	Power Supply	Power Supply Inputs to the Core of the Device.
V _{DDQ}	I/O Power Supply	Power Supply for the I/O Circuitry.
V _{SS}	Ground	Ground for the Device. Should be connected to ground of the system.
NC	–	No Connects. This pin is not connected to the die.
NC(144M, 288M, 576M, 1G)	–	These Pins are Not Connected. They are used for expansion to the 144M, 288M, 576M, and 1G densities.
ZZ	Input-Asynchronous	ZZ “Sleep” Input. This active HIGH input places the device in a non-time critical “sleep” condition with data integrity preserved. During normal operation, this pin must be LOW or left floating. ZZ pin has an internal pull-down.

Functional Overview

The CY7C1470BV33, CY7C1472BV33, and CY7C1474BV33 are synchronous-pipelined Burst NoBL SRAMs designed specifically to eliminate wait states during read or write transitions. All synchronous inputs pass through input registers controlled by the rising edge of the clock. The clock signal is qualified with the Clock Enable input signal (\overline{CEN}). If \overline{CEN} is HIGH, the clock signal is not recognized and all internal states are maintained. All synchronous operations are qualified with \overline{CEN} . All data outputs pass through output registers controlled by the rising edge of the clock. Maximum access delay from the clock rise (t_{CO}) is 3.0 ns (250 MHz device).

Accesses can be initiated by asserting all three Chip Enables (CE_1 , CE_2 , CE_3) active at the rising edge of the clock. If \overline{CEN} is active LOW and $\overline{ADV/LD}$ is asserted LOW, the address presented to the device is latched. The access can either be a read or write operation, depending on the status of the Write Enable (\overline{WE}). $\overline{BW}_{[x]}$ can be used to conduct Byte Write operations.

Write operations are qualified by the Write Enable (\overline{WE}). All writes are simplified with on-chip synchronous self timed write circuitry.

Three synchronous Chip Enables (\overline{CE}_1 , CE_2 , \overline{CE}_3) and an asynchronous Output Enable (\overline{OE}) simplify depth expansion. All operations (reads, writes, and deselected) are pipelined. $\overline{ADV/LD}$ must be driven LOW after the device has been deselected to load a new address for the next operation.

Single Read Accesses

A read access is initiated when the following conditions are satisfied at clock rise: (1) \overline{CEN} is asserted LOW, (2) \overline{CE}_1 , \overline{CE}_2 , and \overline{CE}_3 are ALL asserted active, (3) the input signal \overline{WE} is deasserted HIGH, and (4) $\overline{ADV/LD}$ is asserted LOW. The address presented to the address inputs is latched into the Address Register and presented to the memory core and control logic. The control logic determines that a read access is in progress and allows the requested data to propagate to the input

of the output register. At the rising edge of the next clock the requested data is allowed to propagate through the output register and onto the data bus within 3.0 ns (250 MHz device) provided \overline{OE} is active LOW. After the first clock of the read access the output buffers are controlled by \overline{OE} and the internal control logic. \overline{OE} must be driven LOW to drive out the requested data. During the second clock, a subsequent operation (read, write, or deselect) can be initiated. Deselecting the device is also pipelined. Therefore, when the SRAM is deselected at clock rise by one of the chip enable signals, its output tri-states following the next clock rise.

Burst Read Accesses

The CY7C1470BV33, CY7C1472BV33, and CY7C1474BV33 have an on-chip burst counter that enables the user to supply a single address and conduct up to four reads without reasserting the address inputs. $\overline{ADV/LD}$ must be driven LOW to load a new address into the SRAM, as described in the section [Single Read Accesses](#). The sequence of the burst counter is determined by the MODE input signal. A LOW input on MODE selects a linear burst mode, a HIGH selects an interleaved burst sequence. Both burst counters use A0 and A1 in the burst sequence, and wraps around when incremented sufficiently. A HIGH input on $\overline{ADV/LD}$ increments the internal burst counter regardless of the state of chip enables inputs or \overline{WE} . \overline{WE} is latched at the beginning of a burst cycle. Therefore, the type of access (read or write) is maintained throughout the burst sequence.

Single Write Accesses

Write accesses are initiated when the following conditions are satisfied at clock rise: (1) \overline{CEN} is asserted LOW, (2) \overline{CE}_1 , \overline{CE}_2 , and \overline{CE}_3 are all asserted active, and (3) the signal \overline{WE} is asserted LOW. The address presented to the address inputs is loaded into the Address Register. The write signals are latched into the Control Logic block.

On the subsequent clock rise the data lines are automatically tri-stated regardless of the state of the \overline{OE} input signal. This allows the external logic to present the data on DQ and DQP ($DQ_{a,b,c,d}/DQP_{a,b,c,d}$ for CY7C1470BV33, $DQ_{a,b}/DQP_{a,b}$ for



CY7C1472BV33, and $DQ_{a,b,c,d,e,f,g,h}/DQP_{a,b,c,d,e,f,g,h}$ for CY7C1474BV33). In addition, the address for the subsequent access (read, write, or deselect) is latched into the Address Register (provided the appropriate control signals are asserted).

On the next clock rise the data presented to DQ and DQP ($DQ_{a,b,c,d}/DQP_{a,b,c,d}$ for CY7C1470BV33, $DQ_{a,b}/DQP_{a,b}$ for CY7C1472BV33, and $DQ_{a,b,c,d,e,f,g,h}/DQP_{a,b,c,d,e,f,g,h}$ for CY7C1474BV33) (or a subset for byte write operations, see [Partial Write Cycle Description on page 12](#) for details) inputs is latched into the device and the write is complete.

The data written during the Write operation is controlled by \overline{BW} ($BW_{a,b,c,d}$ for CY7C1470BV33, $BW_{a,b}$ for CY7C1472BV33, and $BW_{a,b,c,d,e,f,g,h}$ for CY7C1474BV33) signals. The CY7C1470BV33, CY7C1472BV33, and CY7C1474BV33 provides Byte Write capability that is described in [Partial Write Cycle Description on page 12](#). Asserting the Write Enable input (\overline{WE}) with the selected \overline{BW} input selectively writes to only the desired bytes. Bytes not selected during a Byte Write operation remain unaltered. A synchronous self timed write mechanism has been provided to simplify the write operations. Byte Write capability has been included to greatly simplify read, modify, or write sequences, which can be reduced to simple Byte Write operations.

Because the CY7C1470BV33, CY7C1472BV33, and CY7C1474BV33 are common I/O devices, data must not be driven into the device while the outputs are active. The \overline{OE} can be deasserted HIGH before presenting data to the DQ and DQP ($DQ_{a,b,c,d}/DQP_{a,b,c,d}$ for CY7C1470BV33, $DQ_{a,b}/DQP_{a,b}$ for CY7C1472BV33, and $DQ_{a,b,c,d,e,f,g,h}/DQP_{a,b,c,d,e,f,g,h}$ for CY7C1474BV33) inputs. Doing so tri-states the output drivers. As a safety precaution, DQ and DQP ($DQ_{a,b,c,d}/DQP_{a,b,c,d}$ for CY7C1470BV33, $DQ_{a,b}/DQP_{a,b}$ for CY7C1472BV33, and $DQ_{a,b,c,d,e,f,g,h}/DQP_{a,b,c,d,e,f,g,h}$ for CY7C1474BV33) are automatically tri-stated during the data portion of a write cycle, regardless of the state of \overline{OE} .

Burst Write Accesses

The CY7C1470BV33, CY7C1472BV33, and CY7C1474BV33 has an on-chip burst counter that enables the user to supply a single address and conduct up to four write operations without reasserting the address inputs. $\overline{ADV/LD}$ must be driven LOW to load the initial address, as described in the section [Single Write](#)

[Accesses on page 9](#). When $\overline{ADV/LD}$ is driven HIGH on the subsequent clock rise, the Chip Enables (\overline{CE}_1 , \overline{CE}_2 , and \overline{CE}_3) and \overline{WE} inputs are ignored and the burst counter is incremented. The correct \overline{BW} ($BW_{a,b,c,d}$ for CY7C1470BV33, $BW_{a,b}$ for CY7C1472BV33, and $BW_{a,b,c,d,e,f,g,h}$ for CY7C1474BV33) inputs must be driven in each cycle of the burst write to write the correct bytes of data.

Sleep Mode

The ZZ input pin is an asynchronous input. Asserting ZZ places the SRAM in a power conservation “sleep” mode. Two clock cycles are required to enter into or exit from this “sleep” mode. While in this mode, data integrity is guaranteed. Accesses pending when entering the “sleep” mode are not considered valid nor is the completion of the operation guaranteed. The device must be deselected before entering the “sleep” mode. \overline{CE}_1 , \overline{CE}_2 , and \overline{CE}_3 , must remain inactive for the duration of t_{ZZREC} after the ZZ input returns LOW.

Interleaved Burst Address Table

(MODE = Floating or V_{DD})

First Address A1:A0	Second Address A1:A0	Third Address A1:A0	Fourth Address A1:A0
00	01	10	11
01	00	11	10
10	11	00	01
11	10	01	00

Linear Burst Address Table

(MODE = GND)

First Address A1:A0	Second Address A1:A0	Third Address A1:A0	Fourth Address A1:A0
00	01	10	11
01	10	11	00
10	11	00	01
11	00	01	10

ZZ Mode Electrical Characteristics

Parameter	Description	Test Conditions	Min	Max	Unit
I_{DDZZ}	Sleep mode standby current	$ZZ \geq V_{DD} - 0.2 V$	–	120	mA
t_{ZZS}	Device operation to ZZ	$ZZ \geq V_{DD} - 0.2 V$	–	$2t_{CYC}$	ns
t_{ZZREC}	ZZ recovery time	$ZZ \leq 0.2 V$	$2t_{CYC}$	–	ns
t_{ZZI}	ZZ active to sleep current	This parameter is sampled	–	$2t_{CYC}$	ns
t_{RZZI}	ZZ Inactive to exit sleep current	This parameter is sampled	0	–	ns



Truth Table

The truth table for CY7C1470BV33, CY7C1472BV33, and CY7C1474BV33 follows. [1, 2, 3, 4, 5, 6, 7]

Operation	Address Used	$\overline{\text{CE}}$	ZZ	$\overline{\text{ADV/LD}}$	$\overline{\text{WE}}$	$\overline{\text{BW}}_x$	$\overline{\text{OE}}$	$\overline{\text{CEN}}$	CLK	DQ
Deselect Cycle	None	H	L	L	X	X	X	L	L–H	Tri-State
Continue Deselect Cycle	None	X	L	H	X	X	X	L	L–H	Tri-State
Read Cycle (Begin Burst)	External	L	L	L	H	X	L	L	L–H	Data Out (Q)
Read Cycle (Continue Burst)	Next	X	L	H	X	X	L	L	L–H	Data Out (Q)
NOP/Dummy Read (Begin Burst)	External	L	L	L	H	X	H	L	L–H	Tri-State
Dummy Read (Continue Burst)	Next	X	L	H	X	X	H	L	L–H	Tri-State
Write Cycle (Begin Burst)	External	L	L	L	L	L	X	L	L–H	Data In (D)
Write Cycle (Continue Burst)	Next	X	L	H	X	L	X	L	L–H	Data In (D)
NOP/Write Abort (Begin Burst)	None	L	L	L	L	H	X	L	L–H	Tri-State
Write Abort (Continue Burst)	Next	X	L	H	X	H	X	L	L–H	Tri-State
Ignore Clock Edge (Stall)	Current	X	L	X	X	X	X	H	L–H	-
Sleep Mode	None	X	H	X	X	X	X	X	X	Tri-State

Notes

1. X = "Don't Care", H = Logic HIGH, L = Logic LOW, $\overline{\text{CE}}$ stands for ALL Chip Enables active. $\overline{\text{BW}}_x = 0$ signifies at least one Byte Write Select is active, $\overline{\text{BW}}_x = \text{Valid}$ signifies that the desired byte write selects are asserted, see [Partial Write Cycle Description on page 12](#) for details.
2. Write is defined by $\overline{\text{WE}}$ and $\overline{\text{BW}}_{[a:d]}$. See [Partial Write Cycle Description on page 12](#) for details.
3. When a write cycle is detected, all IOs are tri-stated, even during Byte Writes.
4. The DQ and DQP pins are controlled by the current cycle and the $\overline{\text{OE}}$ signal.
5. $\overline{\text{CEN}} = \text{H}$ inserts wait states.
6. Device powers up deselected with the IOs in a tri-state condition, regardless of $\overline{\text{OE}}$.
7. $\overline{\text{OE}}$ is asynchronous and is not sampled with the clock rise. It is masked internally during Write cycles. During a read cycle DQ_s and $\text{DQP}_{[a:d]} = \text{tri-state}$ when $\overline{\text{OE}}$ is inactive or when the device is deselected, and $\text{DQ}_s = \text{data}$ when $\overline{\text{OE}}$ is active.



Partial Write Cycle Description

The partial write cycle description for CY7C1470BV33, CY7C1472BV33, and CY7C1474BV33 follows. [8, 9, 10, 11]

Function (CY7C1470BV33)	\overline{WE}	\overline{BW}_d	\overline{BW}_c	\overline{BW}_b	\overline{BW}_a
Read	H	X	X	X	X
Write – No bytes written	L	H	H	H	H
Write Byte a – (DQ _a and DQP _a)	L	H	H	H	L
Write Byte b – (DQ _b and DQP _b)	L	H	H	L	H
Write Bytes b, a	L	H	H	L	L
Write Byte c – (DQ _c and DQP _c)	L	H	L	H	H
Write Bytes c, a	L	H	L	H	L
Write Bytes c, b	L	H	L	L	H
Write Bytes c, b, a	L	H	L	L	L
Write Byte d – (DQ _d and DQP _d)	L	L	H	H	H
Write Bytes d, a	L	L	H	H	L
Write Bytes d, b	L	L	H	L	H
Write Bytes d, b, a	L	L	H	L	L
Write Bytes d, c	L	L	L	H	H
Write Bytes d, c, a	L	L	L	H	L
Write Bytes d, c, b	L	L	L	L	H
Write All Bytes	L	L	L	L	L

Function (CY7C1472BV33)	\overline{WE}	\overline{BW}_b	\overline{BW}_a
Read	H	x	x
Write – No Bytes Written	L	H	H
Write Byte a – (DQ _a and DQP _a)	L	H	L
Write Byte b – (DQ _b and DQP _b)	L	L	H
Write Both Bytes	L	L	L

Function (CY7C1474BV33)	\overline{WE}	\overline{BW}_x
Read	H	x
Write – No Bytes Written	L	H
Write Byte X – (DQ _x and DQP _x)	L	L
Write All Bytes	L	All $\overline{BW} = L$

Notes

- X = "Don't Care", H = Logic HIGH, L = Logic LOW, \overline{CE} stands for ALL Chip Enables active. $\overline{BW}_x = 0$ signifies at least one Byte Write Select is active, $\overline{BW}_x = \text{Valid}$ signifies that the desired byte write selects are asserted, see [Partial Write Cycle Description on page 12](#) for details.
- Write is defined by \overline{WE} and $\overline{BW}_{[a:d]}$. See [Partial Write Cycle Description on page 12](#) for details.
- When a write cycle is detected, all IOs are tri-stated, even during Byte Writes.
- Table lists only a partial listing of the Byte Write combinations. Any combination of $\overline{BW}_{[a:d]}$ is valid. Appropriate Write is based on which Byte Write is active.



IEEE 1149.1 Serial Boundary Scan (JTAG)

The CY7C1470BV33, CY7C1472BV33, and CY7C1474BV33 incorporates a serial boundary scan test access port (TAP). This port operates in accordance with IEEE Standard 1149.1-1990 but does not have the set of functions required for full 1149.1 compliance. These functions from the IEEE specification are excluded because their inclusion places an added delay in the critical speed path of the SRAM. Note that the TAP controller functions in a manner that does not conflict with the operation of other devices using 1149.1 fully compliant TAPs. The TAP operates using JEDEC-standard 3.3 V or 2.5 V I/O logic levels.

The CY7C1470BV33, CY7C1472BV33, and CY7C1474BV33 contains a TAP controller, instruction register, boundary scan register, bypass register, and ID register.

Disabling the JTAG Feature

It is possible to operate the SRAM without using the JTAG feature. To disable the TAP controller, TCK must be tied LOW (V_{SS}) to prevent clocking of the device. TDI and TMS are internally pulled up and may be unconnected. They may alternately be connected to V_{DD} through a pull up resistor. TDO must be left unconnected. During power up, the device comes up in a reset state, which does not interfere with the operation of the device.

Test Access Port (TAP)

Test Clock (TCK)

The test clock is used only with the TAP controller. All inputs are captured on the rising edge of TCK. All outputs are driven from the falling edge of TCK.

Test Mode Select (TMS)

The TMS input is used to give commands to the TAP controller and is sampled on the rising edge of TCK. It is allowable to leave this ball unconnected if the TAP is not used. The ball is pulled up internally, resulting in a logic HIGH level.

Test Data-In (TDI)

The TDI ball is used to serially input information into the registers and can be connected to the input of any of the registers. The register between TDI and TDO is chosen by the instruction that is loaded into the TAP instruction register. For information about loading the instruction register, see the [TAP Controller State Diagram](#). TDI is internally pulled up and can be unconnected if the TAP is unused in an application. TDI is connected to the most significant bit (MSB) of any register.

Test Data-Out (TDO)

The TDO output ball is used to serially clock data-out from the registers. The output is active depending upon the current state of the TAP state machine. The output changes on the falling edge of TCK. TDO is connected to the least significant bit (LSB) of any register.

Performing a TAP Reset

A RESET is performed by forcing TMS HIGH (V_{DD}) for five rising edges of TCK. This RESET does not affect the operation of the SRAM and may be performed while the SRAM is operating.

During power up, the TAP is reset internally to ensure that TDO comes up in a High Z state.

TAP Registers

Registers are connected between the TDI and TDO balls and scans data into and out of the SRAM test circuitry. Only one register can be selected at a time through the instruction register. Data is serially loaded into the TDI ball on the rising edge of TCK. Data is output on the TDO ball on the falling edge of TCK.

Instruction Register

Three bit instructions can be serially loaded into the instruction register. This register is loaded when it is placed between the TDI and TDO balls as shown in the [TAP Controller Block Diagram on page 16](#). During power up, the instruction register is loaded with the IDCODE instruction. It is also loaded with the IDCODE instruction if the controller is placed in a reset state as described in the previous section.

When the TAP controller is in the Capture-IR state, the two least significant bits are loaded with a binary '01' pattern to enable fault isolation of the board-level serial test data path.

Bypass Register

To save time when serially shifting data through registers, it is sometimes advantageous to skip certain chips. The bypass register is a single bit register that can be placed between the TDI and TDO balls. This shifts data through the SRAM with minimal delay. The bypass register is set LOW (V_{SS}) when the BYPASS instruction is executed.

Boundary Scan Register

The boundary scan register is connected to all the input and bidirectional balls on the SRAM.

The boundary scan register is loaded with the contents of the RAM I/O ring when the TAP controller is in the Capture-DR state and is then placed between the TDI and TDO balls when the controller is moved to the Shift-DR state. The EXTEST, SAMPLE/PRELOAD and SAMPLE Z instructions can be used to capture the contents of the I/O ring.

The Boundary Scan Order tables show the order in which the bits are connected. Each bit corresponds to one of the bumps on the SRAM package. The MSB of the register is connected to TDI and the LSB is connected to TDO.

Identification (ID) Register

The ID register is loaded with a vendor-specific, 32 bit code during the Capture-DR state when the IDCODE command is loaded in the instruction register. The IDCODE is hardwired into the SRAM and can be shifted out when the TAP controller is in the Shift-DR state. The ID register has a vendor code and other information described in [Identification Register Definitions on page 20](#).



TAP Instruction Set

Overview

Eight different instructions are possible with the three bit instruction register. All combinations are listed in [Identification Codes on page 20](#). Three of these instructions are listed as RESERVED and must not be used. The other five instructions are described in this section in detail.

The TAP controller used in this SRAM is not fully compliant to the 1149.1 convention because some of the mandatory 1149.1 instructions are not fully implemented.

The TAP controller cannot be used to load address data or control signals into the SRAM and cannot preload the I/O buffers. The SRAM does not implement the 1149.1 commands EXTEST or INTEST or the PRELOAD portion of SAMPLE/PRELOAD; rather, it performs a capture of the I/O ring when these instructions are executed.

Instructions are loaded into the TAP controller during the Shift-IR state when the instruction register is placed between TDI and TDO. During this state, instructions are shifted through the instruction register through the TDI and TDO balls. To execute the instruction after it is shifted in, the TAP controller is moved into the Update-IR state.

EXTEST

EXTEST is a mandatory 1149.1 instruction which is executed whenever the instruction register is loaded with all 0s. EXTEST is not implemented in this SRAM TAP controller, and therefore this device is not compliant to 1149.1. The TAP controller does recognize an all-0 instruction.

When an EXTEST instruction is loaded into the instruction register, the SRAM responds as if a SAMPLE/PRELOAD instruction has been loaded. There is one difference between the two instructions. Unlike the SAMPLE/PRELOAD instruction, EXTEST places the SRAM outputs in a High Z state.

IDCODE

The IDCODE instruction loads a vendor-specific, 32 bit code into the instruction register. It also places the instruction register between the TDI and TDO balls and shifts the IDCODE out of the device when the TAP controller enters the Shift-DR state.

The IDCODE instruction is loaded into the instruction register during power up or whenever the TAP controller is in a test logic reset state.

SAMPLE Z

The SAMPLE Z instruction connects the boundary scan register between the TDI and TDO balls when the TAP controller is in a

Shift-DR state. It also places all SRAM outputs into a High Z state.

SAMPLE/PRELOAD

SAMPLE/PRELOAD is a 1149.1 mandatory instruction. The PRELOAD portion of this instruction is not implemented, so the device TAP controller is not fully 1149.1 compliant.

When the SAMPLE/PRELOAD instruction is loaded into the instruction register and the TAP controller is in the Capture-DR state, a snapshot of data on the inputs and bidirectional balls is captured in the boundary scan register.

The user must be aware that the TAP controller clock can only operate at a frequency up to 20 MHz, while the SRAM clock operates more than an order of magnitude faster. Because there is a large difference in the clock frequencies, it is possible that during the Capture-DR state, an input or output may undergo a transition. The TAP may then try to capture a signal while in transition (metastable state). This does not harm the device, but there is no guarantee as to the value that is captured. Repeatable results may not be possible.

To guarantee that the boundary scan register captures the correct value of a signal, the SRAM signal must be stabilized long enough to meet the TAP controller's capture setup plus hold time (t_{CS} plus t_{CH}).

The SRAM clock input might not be captured correctly if there is no way in a design to stop (or slow) the clock during a SAMPLE/PRELOAD instruction. If this is an issue, it is still possible to capture all other signals and simply ignore the value of the CLK captured in the boundary scan register.

After the data is captured, it is possible to shift out the data by putting the TAP into the Shift-DR state. This places the boundary scan register between the TDI and TDO balls.

Note that since the PRELOAD part of the command is not implemented, putting the TAP to the Update-DR state while performing a SAMPLE/PRELOAD instruction has the same effect as the Pause-DR command.

BYPASS

When the BYPASS instruction is loaded in the instruction register and the TAP is placed in a Shift-DR state, the bypass register is placed between the TDI and TDO balls. The advantage of the BYPASS instruction is that it shortens the boundary scan path when multiple devices are connected together on a board.

Reserved

These instructions are not implemented but are reserved for future use. Do not use these instructions.



TAP Controller State Diagram

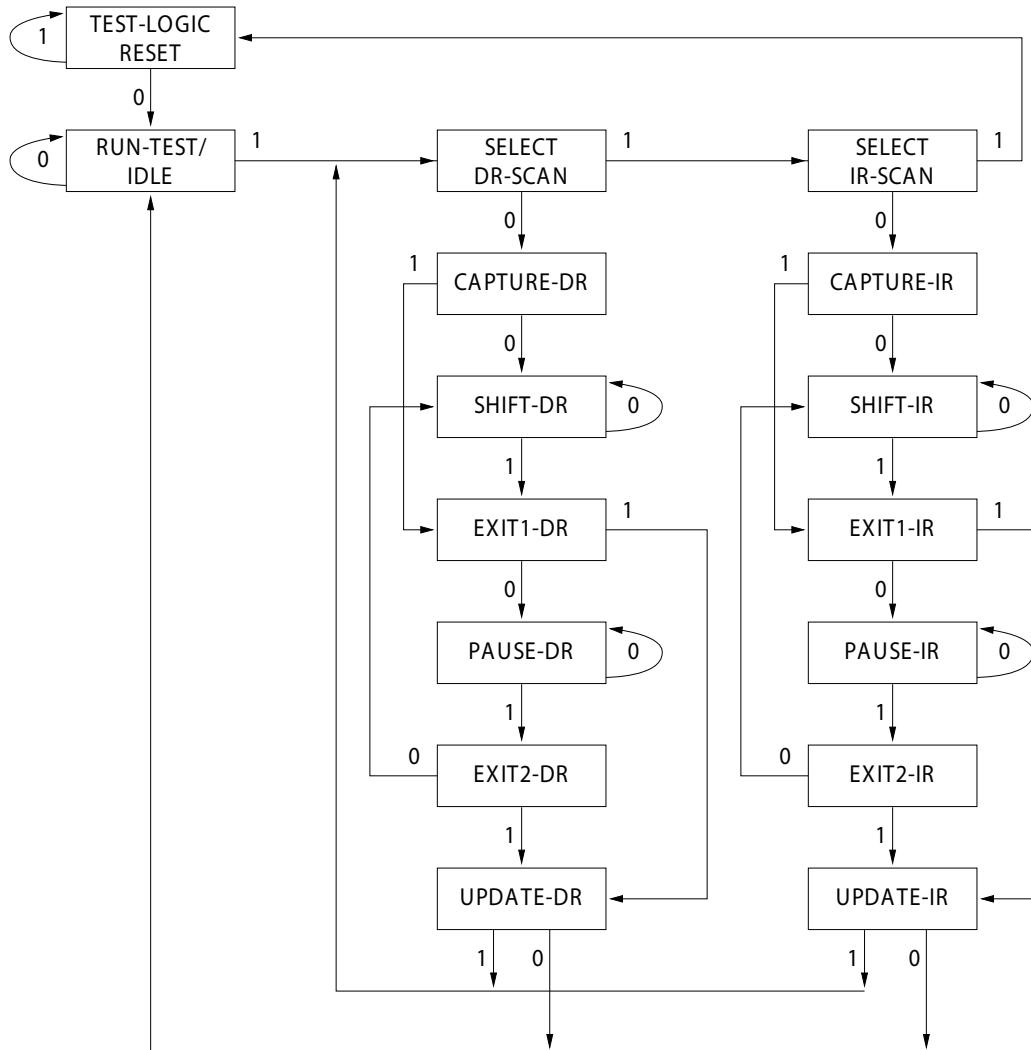

The 0/1 next to each state represents the value of TMS at the rising edge of TCK.



TAP Controller Block Diagram

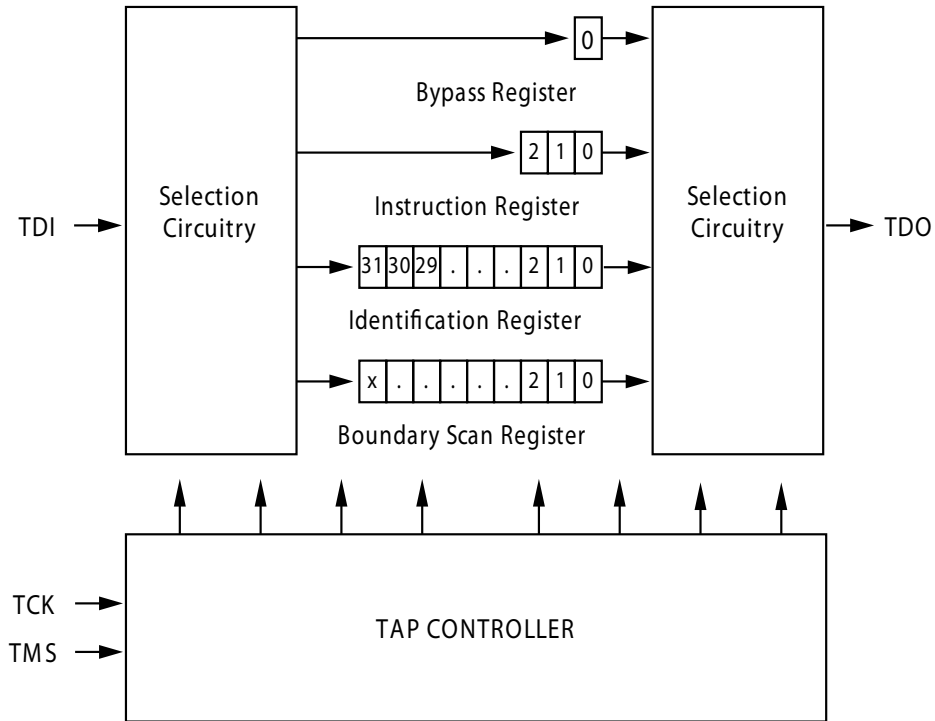

TAP Timing

Figure 4. TAP Timing

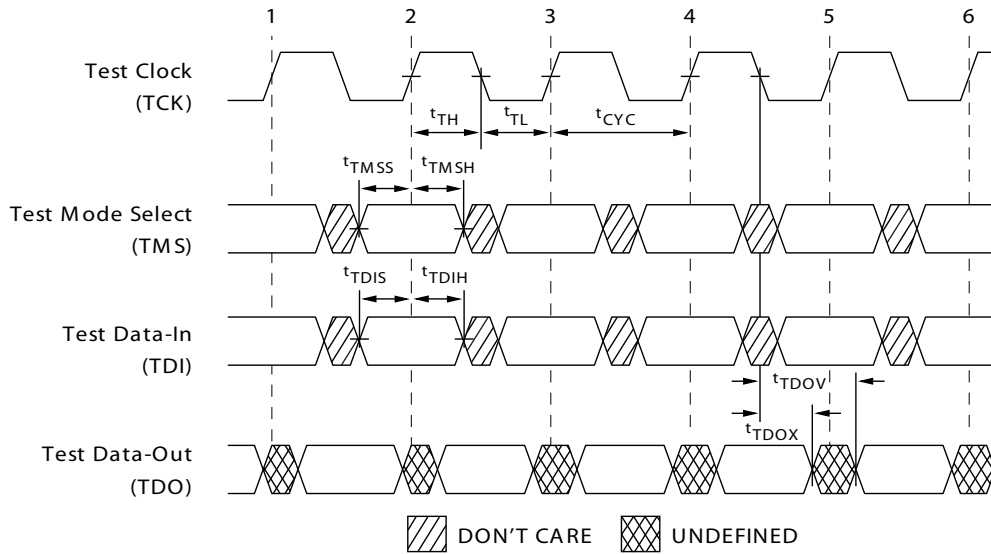



TAP AC Switching Characteristics

Over the Operating Range

Parameter ^[12, 13]	Description	Min	Max	Unit
Clock				
t_{TCYC}	TCK Clock Cycle Time	50	–	ns
t_{TF}	TCK Clock Frequency	–	20	MHz
t_{TH}	TCK Clock HIGH time	20	–	ns
t_{TL}	TCK Clock LOW time	20	–	ns
Output Times				
t_{TDOV}	TCK Clock LOW to TDO Valid	–	10	ns
t_{TDOX}	TCK Clock LOW to TDO Invalid	0	–	ns
Setup Times				
t_{TMSS}	TMS Setup to TCK Clock Rise	5	–	ns
t_{TDIS}	TDI Setup to TCK Clock Rise	5	–	ns
t_{CS}	Capture Setup to TCK Rise	5	–	ns
Hold Times				
t_{TMSh}	TMS Hold after TCK Clock Rise	5	–	ns
t_{TDIH}	TDI Hold after Clock Rise	5	–	ns
t_{CH}	Capture Hold after Clock Rise	5	–	ns

Notes

12. t_{CS} and t_{CH} refer to the setup and hold time requirements of latching data from the boundary scan register.
 13. Test conditions are specified using the load in TAP AC Test Conditions. $t_R/t_F = 1$ ns.



3.3 V TAP AC Test Conditions

Input pulse levels V_{SS} to 3.3 V
 Input rise and fall times 1 ns
 Input timing reference levels 1.5 V
 Output reference levels 1.5 V
 Test load termination supply voltage 1.5 V

3.3 V TAP AC Output Load Equivalent

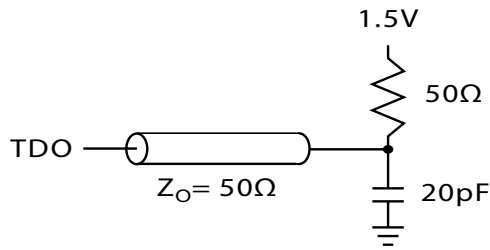

2.5 V TAP AC Test Conditions

Input pulse levels V_{SS} to 2.5 V
 Input rise and fall time 1 ns
 Input timing reference levels 1.25 V
 Output reference levels 1.25 V
 Test load termination supply voltage 1.25 V

2.5 V TAP AC Output Load Equivalent

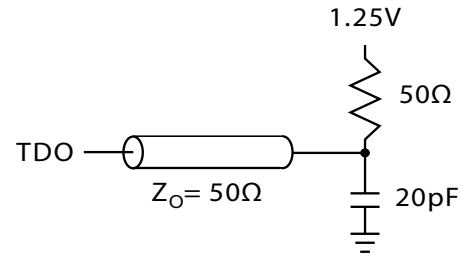

TAP DC Electrical Characteristics and Operating Conditions

(0 °C < T_A < +70 °C; V_{DD} = 3.135 V to 3.6 V unless otherwise noted)

Parameter ^[14]	Description	Test Conditions	Min	Max	Unit
V _{OH1}	Output HIGH Voltage	I _{OH} = -4.0 mA, V _{DDQ} = 3.3 V	2.4	-	V
		I _{OH} = -1.0 mA, V _{DDQ} = 2.5 V	2.0	-	V
V _{OH2}	Output HIGH Voltage	I _{OH} = -100 μA, V _{DDQ} = 3.3 V	2.9	-	V
		I _{OH} = -100 μA, V _{DDQ} = 2.5 V	2.1	-	V
V _{OL1}	Output LOW Voltage	I _{OL} = 8.0 mA, V _{DDQ} = 3.3 V	-	0.4	V
		I _{OL} = 1.0 mA, V _{DDQ} = 2.5 V	-	0.4	V
V _{OL2}	Output LOW Voltage	I _{OL} = 100 μA, V _{DDQ} = 3.3 V	-	0.2	V
		I _{OL} = 100 μA, V _{DDQ} = 2.5 V	-	0.2	V
V _{IH}	Input HIGH Voltage	V _{DDQ} = 3.3 V	2.0	V _{DD} + 0.3	V
		V _{DDQ} = 2.5 V	1.7	V _{DD} + 0.3	V
V _{IL}	Input LOW Voltage	V _{DDQ} = 3.3 V	-0.3	0.8	V
		V _{DDQ} = 2.5 V	-0.3	0.7	V
I _X	Input Load Current	GND ≤ V _{IN} ≤ V _{DDQ}	-5	5	μA

Note

14. All voltages refer to V_{SS} (GND).



Identification Register Definitions

Instruction Field	CY7C1470BV33 (2M × 36)	CY7C1472BV33 (4M × 18)	CY7C1474BV33 (1M × 72)	Description
Revision Number (31:29)	000	000	000	Describes the version number
Device Depth (28:24) ^[15]	01011	01011	01011	Reserved for internal use
Architecture/Memory Type(23:18)	001000	001000	001000	Defines memory type and architecture
Bus Width/Density(17:12)	100100	010100	110100	Defines width and density
Cypress JEDEC ID Code (11:1)	00000110100	00000110100	00000110100	Enables unique identification of SRAM vendor
ID Register Presence Indicator (0)	1	1	1	Indicates the presence of an ID register

Scan Register Sizes

Register Name	Bit Size (× 36)	Bit Size (× 18)	Bit Size (× 72)
Instruction	3	3	3
Bypass	1	1	1
ID	32	32	32
Boundary Scan Order – 165-ball FBGA	71	52	–
Boundary Scan Order – 209-ball FBGA	–	–	110

Identification Codes

Instruction	Code	Description
EXTEST	000	Captures I/O ring contents. Places the boundary scan register between TDI and TDO. Forces all SRAM outputs to High Z state. This instruction is not 1149.1 compliant.
IDCODE	001	Loads the ID register with the vendor ID code and places the register between TDI and TDO. This operation does not affect SRAM operations.
SAMPLE Z	010	Captures I/O ring contents. Places the boundary scan register between TDI and TDO. Forces all SRAM output drivers to a High Z state.
RESERVED	011	Do Not Use: This instruction is reserved for future use.
SAMPLE/PRELOAD	100	Captures I/O ring contents. Places the boundary scan register between TDI and TDO. Does not affect SRAM operation. This instruction does not implement 1149.1 preload function and is therefore not 1149.1 compliant.
RESERVED	101	Do Not Use: This instruction is reserved for future use.

Note

15. Bit #24 is "1" in the ID Register Definitions for both 2.5 V and 3.3 V versions of this device.



Boundary Scan Exit Order

(2M × 36)

Bit #	165-ball ID
1	C1
2	D1
3	E1
4	D2
5	E2
6	F1
7	G1
8	F2
9	G2
10	J1
11	K1
12	L1
13	J2
14	M1
15	N1
16	K2
17	L2
18	M2
19	R1
20	R2

Bit #	165-ball ID
21	R3
22	P2
23	R4
24	P6
25	R6
26	R8
27	P3
28	P4
29	P8
30	P9
31	P10
32	R9
33	R10
34	R11
35	N11
36	M11
37	L11
38	M10
39	L10
40	K11

Bit #	165-ball ID
41	J11
42	K10
43	J10
44	H11
45	G11
46	F11
47	E11
48	D10
49	D11
50	C11
51	G10
52	F10
53	E10
54	A9
55	B9
56	A10
57	B10
58	A8
59	B8
60	A7

Bit #	165-ball ID
61	B7
62	B6
63	A6
64	B5
65	A5
66	A4
67	B4
68	B3
69	A3
70	A2
71	B2

Boundary Scan Exit Order

(4M × 18)

Bit #	165-ball ID
1	D2
2	E2
3	F2
4	G2
5	J1
6	K1
7	L1
8	M1
9	N1
10	R1
11	R2
12	R3
13	P2

Bit #	165-ball ID
14	R4
15	P6
16	R6
17	R8
18	P3
19	P4
20	P8
21	P9
22	P10
23	R9
24	R10
25	R11
26	M10

Bit #	165-ball ID
27	L10
28	K10
29	J10
30	H11
31	G11
32	F11
33	E11
34	D11
35	C11
36	A11
37	A9
38	B9
39	A10

Bit #	165-ball ID
40	B10
41	A8
42	B8
43	A7
44	B7
45	B6
46	A6
47	B5
48	A4
49	B3
50	A3
51	A2
52	B2



Boundary Scan Exit Order

(1M × 72)

Bit #	209-ball ID	Bit #	209-ball ID	Bit #	209-ball ID	Bit #	209-ball ID
1	A1	29	T1	57	U10	85	B11
2	A2	30	T2	58	T11	86	B10
3	B1	31	U1	59	T10	87	A11
4	B2	32	U2	60	R11	88	A10
5	C1	33	V1	61	R10	89	A7
6	C2	34	V2	62	P11	90	A5
7	D1	35	W1	63	P10	91	A9
8	D2	36	W2	64	N11	92	U8
9	E1	37	T6	65	N10	93	A6
10	E2	38	V3	66	M11	94	D6
11	F1	39	V4	67	M10	95	K6
12	F2	40	U4	68	L11	96	B6
13	G1	41	W5	69	L10	97	K3
14	G2	42	V6	70	P6	98	A8
15	H1	43	W6	71	J11	99	B4
16	H2	44	V5	72	J10	100	B3
17	J1	45	U5	73	H11	101	C3
18	J2	46	U6	74	H10	102	C4
19	L1	47	W7	75	G11	103	C8
20	L2	48	V7	76	G10	104	C9
21	M1	49	U7	77	F11	105	B9
22	M2	50	V8	78	F10	106	B8
23	N1	51	V9	79	E10	107	A4
24	N2	52	W11	80	E11	108	C6
25	P1	53	W10	81	D11	109	B7
26	P2	54	V11	82	D10	110	A3
27	R2	55	V10	83	C11		
28	R1	56	U11	84	C10		



Maximum Ratings

Exceeding maximum ratings may impair the useful life of the device. These user guidelines are not tested.

Storage Temperature -65 °C to +150 °C
 Ambient Temperature with
 Power Applied -55 °C to +125 °C
 Supply Voltage on V_{DD} Relative to GND -0.5 V to +4.6 V
 Supply Voltage on V_{DDQ} Relative to GND -0.5 V to +V_{DD}
 DC to Outputs in Tri-State -0.5 V to V_{DDQ} + 0.5 V
 DC Input Voltage -0.5 V to V_{DD} + 0.5 V
 Current into Outputs (LOW) 20 mA
 Static Discharge Voltage
 (MIL-STD-883, Method 3015) > 2001V
 Latch Up Current > 200 mA

Operating Range

Range	Ambient Temperature	V _{DD}	V _{DDQ}
Commercial	0 °C to +70 °C	3.3 V – 5% / +10%	2.5 V – 5% to V _{DD}
Industrial	-40 °C to +85 °C		

Neutron Soft Error Immunity

Parameter	Description	Test Conditions	Typ	Max*	Unit
LSBU	Logical Single Bit Upsets	25 °C	361	394	FIT/Mb
LMBU	Logical Multi Bit Upsets	25 °C	0	0.01	FIT/Mb
SEL	Single Event Latch up	85 °C	0	0.1	FIT/Dev

* No LMBU or SEL events occurred during testing; this column represents a statistical χ^2 , 95% confidence limit calculation. For more details refer to Application Note AN54908 "Accelerated Neutron SER Testing and Calculation of Terrestrial Failure Rates".

Electrical Characteristics

Over the Operating Range

Parameter ^[16, 17]	Description	Test Conditions	Min	Max	Unit
V _{DD}	Power supply voltage		3.135	3.6	V
V _{DDQ}	I/O supply voltage	For 3.3 V I/O	3.135	V _{DD}	V
		For 2.5 V I/O	2.375	2.625	V
V _{OH}	Output HIGH voltage	For 3.3 V I/O, I _{OH} = -4.0 mA	2.4	-	V
		For 2.5 V I/O, I _{OH} = -1.0 mA	2.0	-	V
V _{OL}	Output LOW voltage	For 3.3 V I/O, I _{OL} = 8.0 mA	-	0.4	V
		For 2.5 V I/O, I _{OL} = 1.0 mA	-	0.4	V
V _{IH}	Input HIGH voltage ^[16]	For 3.3 V I/O	2.0	V _{DD} + 0.3	V
		For 2.5 V I/O	1.7	V _{DD} + 0.3	V
V _{IL}	Input LOW voltage ^[16]	For 3.3 V I/O	-0.3	0.8	V
		For 2.5 V I/O	-0.3	0.7	V
I _X	Input leakage current except ZZ and MODE	GND ≤ V _I ≤ V _{DDQ}	-5	5	μA
	Input current of MODE	Input = V _{SS}	-30	-	μA
		Input = V _{DD}	-	5	μA
	Input current of ZZ	Input = V _{SS}	-5	-	μA
Input = V _{DD}		-	30	μA	
I _{OZ}	Output leakage current	GND ≤ V _I ≤ V _{DDQ} , output disabled	-5	5	μA

Notes

16. Overshoot: V_{IH(AC)} < V_{DD} + 1.5 V (pulse width less than t_{CYC/2}). Undershoot: V_{IL(AC)} > -2 V (pulse width less than t_{CYC/2}).
 17. T_{power up}: assumes a linear ramp from 0 V to V_{DD(min)} within 200 ms. During this time V_{IH} < V_{DD} and V_{DDQ} ≤ V_{DD}.



Electrical Characteristics (continued)

Over the Operating Range

Parameter ^[16, 17]	Description	Test Conditions	Min	Max	Unit	
I _{DD} ^[18]	V _{DD} Operating Supply	V _{DD} = Max, I _{OUT} = 0 mA, f = f _{MAX} = 1/t _{CYC}	4.0-ns cycle, 250 MHz	–	500	mA
			5.0-ns cycle, 200 MHz	–	500	mA
			6.0-ns cycle, 167 MHz	–	450	mA
I _{SB1}	Automatic CE power-down current – TTL Inputs	Max V _{DD} , Device Deselected, V _{IN} ≥ V _{IH} or V _{IN} ≤ V _{IL} , f = f _{MAX} = 1/t _{CYC}	4.0-ns cycle, 250 MHz	–	245	mA
			5.0-ns cycle, 200 MHz	–	245	mA
			6.0-ns cycle, 167 MHz	–	245	mA
I _{SB2}	Automatic CE power-down current – CMOS Inputs	Max V _{DD} , Device Deselected, V _{IN} ≤ 0.3 V or V _{IN} ≥ V _{DDQ} – 0.3 V, f = 0	All speed grades	–	120	mA
I _{SB3}	Automatic CE power-down current – CMOS Inputs	Max V _{DD} , Device Deselected, V _{IN} ≤ 0.3 V or V _{IN} ≥ V _{DDQ} – 0.3 V, f = f _{MAX} = 1/t _{CYC}	4.0-ns cycle, 250 MHz	–	245	mA
			5.0-ns cycle, 200 MHz	–	245	mA
			6.0-ns cycle, 167 MHz	–	245	mA
I _{SB4}	Automatic CE Power Down Current – TTL Inputs	Max V _{DD} , Device Deselected, V _{IN} ≥ V _{IH} or V _{IN} ≤ V _{IL} , f = 0	All speed grades	–	135	mA

Note

18. The operation current is calculated with 50% read cycle and 50% write cycle.



Capacitance

Parameter ^[19]	Description	Test Conditions	100-pin TQFP Max	165-ball FBGA Max	209-ball FBGA Max	Unit
C _{ADDRESS}	Address input capacitance	T _A = 25 °C, f = 1 MHz, V _{DD} = 3.3 V, V _{DDQ} = 2.5 V	6	6	6	pF
C _{DATA}	Data input capacitance		5	5	5	pF
C _{CTRL}	Control input capacitance		8	8	8	pF
C _{CLK}	Clock input capacitance		6	6	6	pF
C _{I/O}	I/O capacitance		5	5	5	pF

Thermal Resistance

Parameter ^[19]	Description	Test Conditions	100-pin TQFP Package	165-ball FBGA Package	209-ball FBGA Package	Unit
Θ _{JA}	Thermal resistance (junction to ambient)	Test conditions follow standard test methods and procedures for measuring thermal impedance, per EIA/JESD51.	24.63	16.3	15.2	°C/W
Θ _{JC}	Thermal resistance (junction to case)		2.28	2.1	1.7	°C/W

AC Test Loads and Waveforms

Figure 5. AC Test Loads and Waveforms

3.3 V I/O Test Load

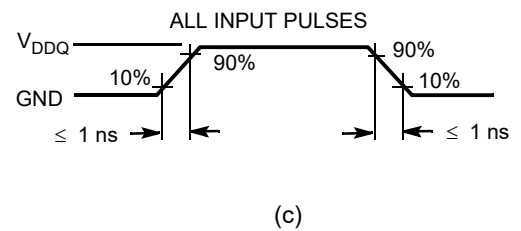
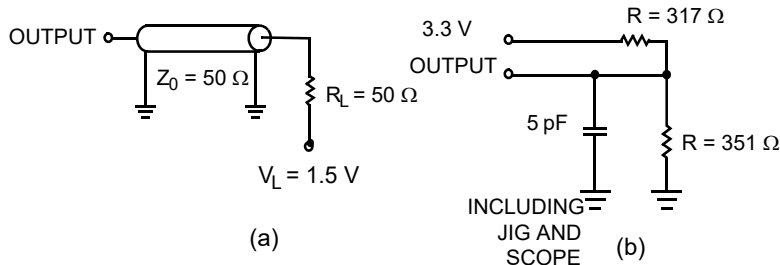

2.5 V I/O Test Load

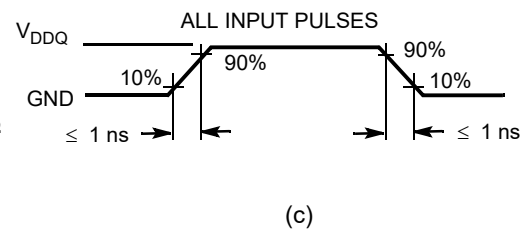
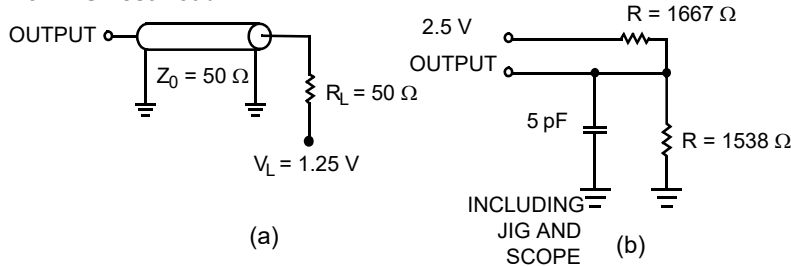

Note

19. Tested initially and after any design or process changes that may affect these parameters.



Switching Characteristics

Over the Operating Range

Parameter [20, 21]	Description	-250		-200		-167		Unit
		Min	Max	Min	Max	Min	Max	
$t_{Power}^{[22]}$	V_{CC} (typical) to the first access read or write	1	–	1	–	1	–	ms
Clock								
t_{CYC}	Clock cycle time	4.0	–	5.0	–	6.0	–	ns
F_{MAX}	Maximum operating frequency	–	250	–	200	–	167	MHz
t_{CH}	Clock HIGH	2.0	–	2.0	–	2.2	–	ns
t_{CL}	Clock LOW	2.0	–	2.0	–	2.2	–	ns
Output Times								
t_{CO}	Data output valid after CLK rise	–	3.0	–	3.0	–	3.4	ns
$t_{OE\bar{V}}$	\overline{OE} LOW to output valid	–	3.0	–	3.0	–	3.4	ns
t_{DOH}	Data output hold after CLK rise	1.3	–	1.3	–	1.5	–	ns
t_{CHZ}	Clock to high Z [23, 24, 25]	–	3.0	–	3.0	–	3.4	ns
t_{CLZ}	Clock to low Z [23, 24, 25]	1.3	–	1.3	–	1.5	–	ns
t_{EOHZ}	\overline{OE} HIGH to output high Z [23, 24, 25]	–	3.0	–	3.0	–	3.4	ns
t_{EOLZ}	\overline{OE} LOW to output low Z [23, 24, 25]	0	–	0	–	0	–	ns
Setup Times								
t_{AS}	Address setup before CLK rise	1.4	–	1.4	–	1.5	–	ns
t_{DS}	Data input setup before CLK rise	1.4	–	1.4	–	1.5	–	ns
t_{CENS}	\overline{CEN} setup before CLK rise	1.4	–	1.4	–	1.5	–	ns
t_{WES}	\overline{WE} , \overline{BW}_x setup before CLK rise	1.4	–	1.4	–	1.5	–	ns
t_{ALS}	ADV/LD setup before CLK rise	1.4	–	1.4	–	1.5	–	ns
t_{CES}	Chip select setup	1.4	–	1.4	–	1.5	–	ns
Hold Times								
t_{AH}	Address hold after CLK rise	0.4	–	0.4	–	0.5	–	ns
t_{DH}	Data input hold after CLK rise	0.4	–	0.4	–	0.5	–	ns
t_{CENH}	\overline{CEN} hold after CLK rise	0.4	–	0.4	–	0.5	–	ns
t_{WEH}	\overline{WE} , \overline{BW}_x hold after CLK rise	0.4	–	0.4	–	0.5	–	ns
t_{ALH}	ADV/LD hold after CLK rise	0.4	–	0.4	–	0.5	–	ns
t_{CEH}	Chip select hold after CLK rise	0.4	–	0.4	–	0.5	–	ns

Notes

20. Timing reference is 1.5 V when $V_{DDQ} = 3.3$ V and is 1.25 V when $V_{DDQ} = 2.5$ V.
 21. Test conditions shown in (a) of Figure 5 on page 25 unless otherwise noted.
 22. This part has an internal voltage regulator; t_{Power} is the time power is supplied above V_{DD} minimum initially, before a read or write operation can be initiated.
 23. t_{CHZ} , t_{CLZ} , t_{EOLZ} , and t_{EOHZ} are specified with AC test conditions shown in (b) of Figure 5 on page 25. Transition is measured ± 200 mV from steady-state voltage.
 24. At any voltage and temperature, t_{EOHZ} is less than t_{EOLZ} and t_{CHZ} is less than t_{CLZ} to eliminate bus contention between SRAMs when sharing the same data bus. These specifications do not imply a bus contention condition, but reflect parameters guaranteed over worst case user conditions. Device is designed to achieve High Z before Low Z under the same system conditions.
 25. This parameter is sampled and not 100% tested.



Switching Waveforms

Figure 6. Read/Write Timing [26, 27, 28]

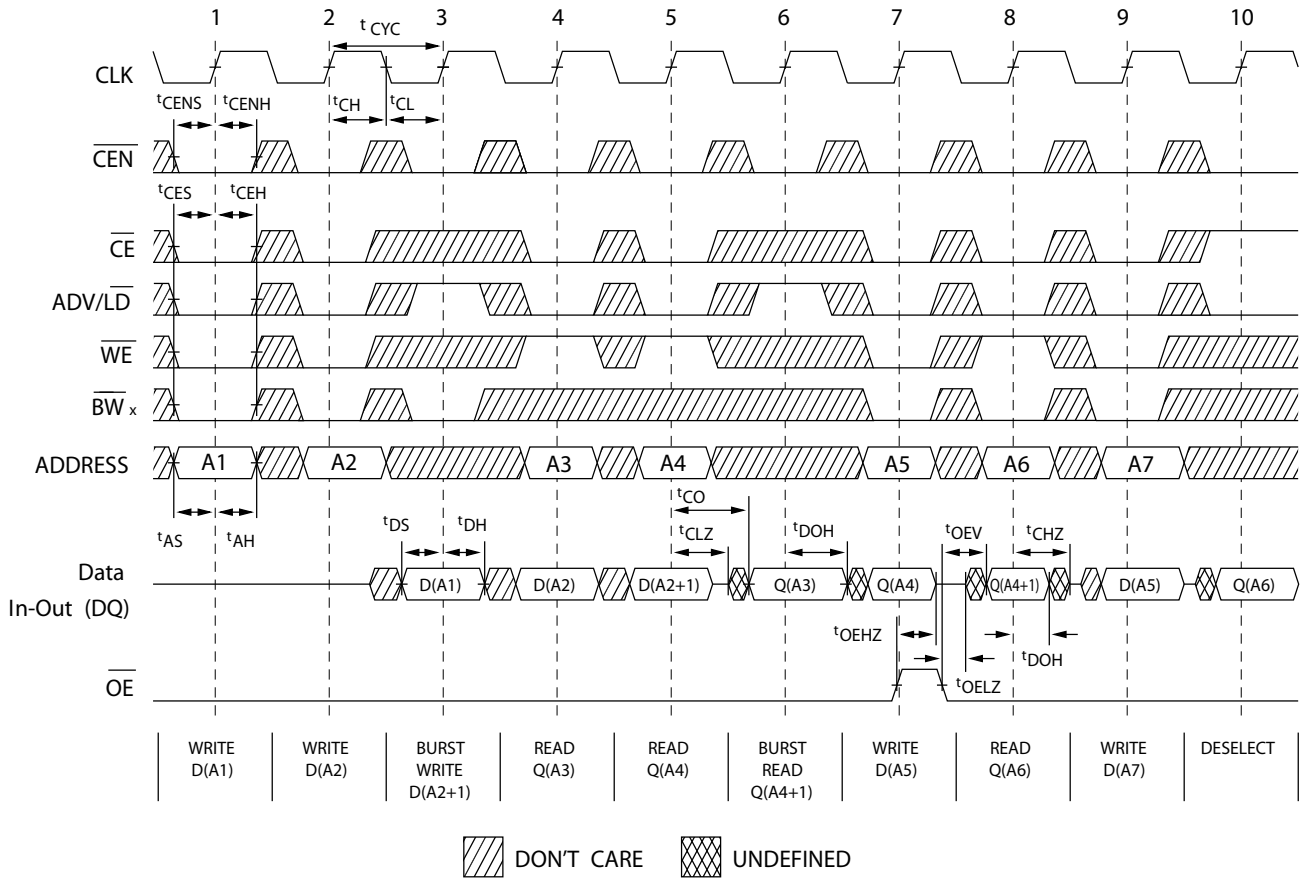

Notes

26. For this waveform ZZ is tied LOW.

27. When \overline{CE} is LOW, \overline{CE}_1 is LOW, \overline{CE}_2 is HIGH, and \overline{CE}_3 is LOW. When \overline{CE} is HIGH, \overline{CE}_1 is HIGH, \overline{CE}_2 is LOW or \overline{CE}_3 is HIGH.

28. Order of the Burst sequence is determined by the status of the MODE (0 = Linear, 1 = Interleaved). Burst operations are optional.



Switching Waveforms (continued)

Figure 7. NOP, STALL and DESELECT Cycles [29, 30, 31]

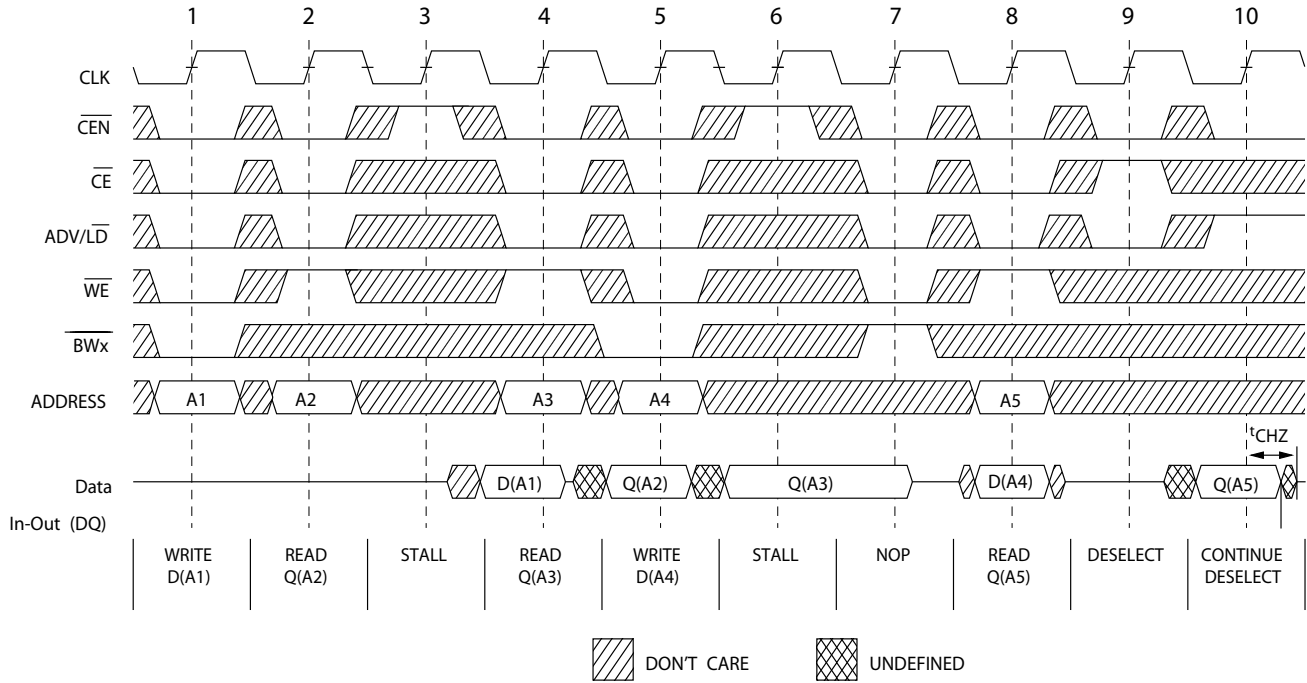
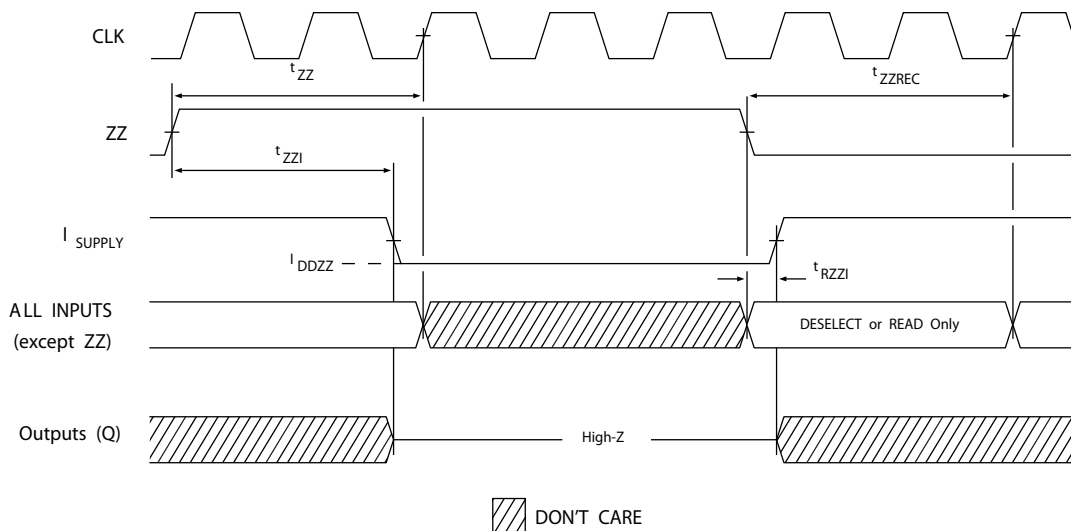

Figure 8. ZZ Mode Timing [32, 33]



Notes

- 29. For this waveform ZZ is tied LOW.
- 30. When CE is LOW, CE₁ is LOW, CE₂ is HIGH, and CE₃ is LOW. When CE is HIGH, CE₁ is HIGH, CE₂ is LOW or CE₃ is HIGH.
- 31. The IGNORE CLOCK EDGE or STALL cycle (Clock 3) illustrated CEN being used to create a pause. A Write is not performed during this cycle.
- 32. Device must be deselected when entering ZZ mode. See Truth Table on page 11 for all possible signal conditions to deselect the device.
- 33. IOs are in High Z when exiting ZZ sleep mode.



Ordering Information

The table below contains only the parts that are currently available. If you don't see what you are looking for, please contact your local sales representative. For more information, visit the Cypress website at www.cypress.com and refer to the product summary page at <http://www.cypress.com/products>.

Cypress maintains a worldwide network of offices, solution centers, manufacturer's representatives and distributors. To find the office closest to you, visit us at <http://www.cypress.com/go/datasheet/offices>.

Speed (MHz)	Ordering Code	Package Diagram	Part and Package Type	Operating Range
167	CY7C1470BV33-167AXC	51-85050	100-pin TQFP (14 × 20 × 1.4 mm) Pb-free	Commercial
	CY7C1470BV33-167BZXC	51-85165	165-ball FBGA (15 × 17 × 1.4 mm) Pb-free	
	CY7C1470BV33-167AXI	51-85050	100-pin TQFP (14 × 20 × 1.4 mm) Pb-free	Industrial
	CY7C1472BV33-167AXI			
	CY7C1470BV33-167BZI	51-85165	165-ball FBGA (15 × 17 × 1.4 mm)	
200	CY7C1470BV33-200AXC	51-85050	100-pin TQFP (14 × 20 × 1.4 mm) Pb-free	Commercial
	CY7C1472BV33-200BZXC	51-85165	165-ball FBGA (15 × 17 × 1.4 mm) Pb-free	
	CY7C1474BV33-200BGXC	51-85167	209-ball FBGA (14 × 22 × 1.76 mm) Pb-free	
	CY7C1470BV33-200AXI	51-85050	100-pin TQFP (14 × 20 × 1.4 mm) Pb-free	Industrial
	CY7C1470BV33-200BZXI	51-85165	165-ball FBGA (15 × 17 × 1.4 mm) Pb-free	
250	CY7C1470BV33-250BZXC	51-85165	165-ball FBGA (15 × 17 × 1.4 mm) Pb-free	Commercial

Ordering Code Definitions

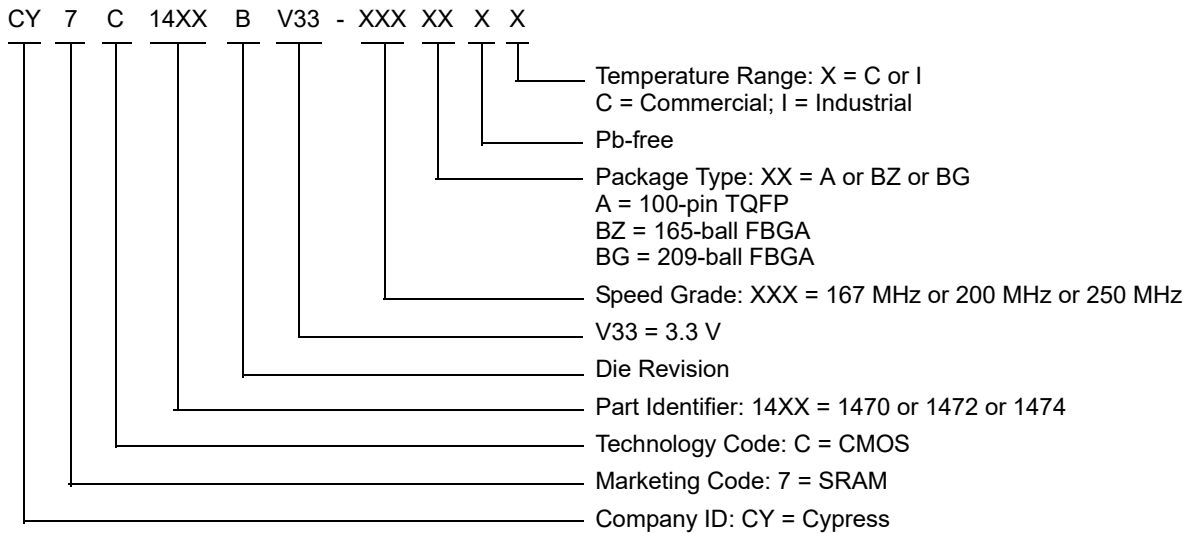



Package Diagrams

Figure 9. 100-pin TQFP (14 × 20 × 1.4 mm) A100RA Package Outline, 51-85050

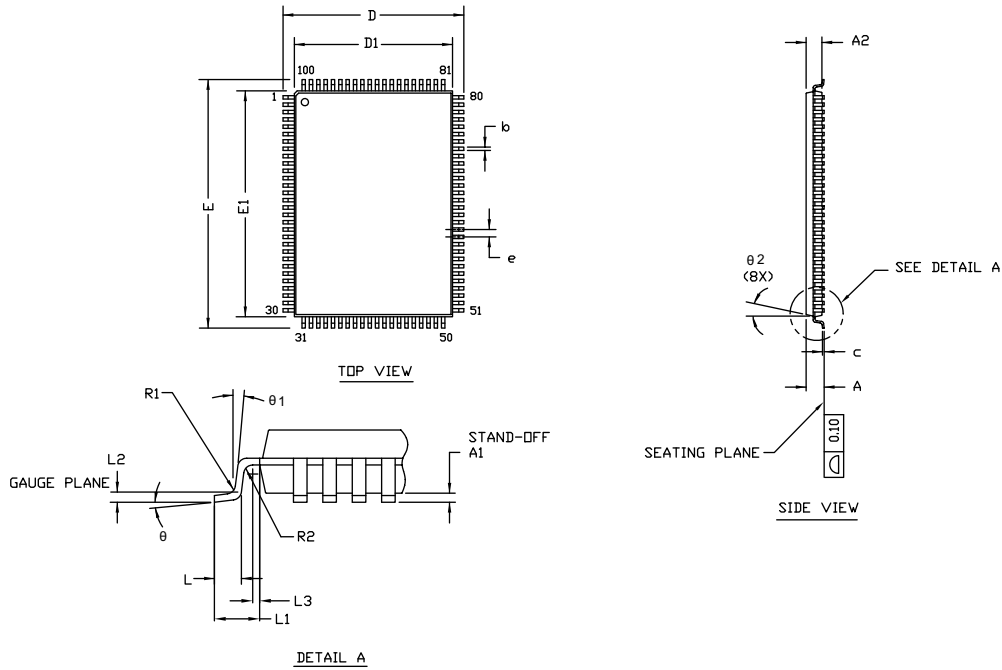

SYMBOL	DIMENSIONS		
	MIN.	NOM.	MAX.
A	—	—	1.60
A1	0.05	—	0.15
A2	1.35	1.40	1.45
D	15.80	16.00	16.20
D1	13.90	14.00	14.10
E	21.80	22.00	22.20
E1	19.90	20.00	20.10
R1	0.08	—	0.20
R2	0.08	—	0.20
θ	0°	—	7°
θ1	0°	—	—
θ2	11°	12°	13°
c	—	—	0.20
b	0.22	0.30	0.38
L	0.45	0.60	0.75
L1	1.00 REF		
L2	0.25 BSC		
L3	0.20	—	—
e	0.65 TYP		

- NOTE:
- ALL DIMENSIONS ARE IN MILLIMETERS.
 - BODY LENGTH DIMENSION DOES NOT INCLUDE MOLD PROTRUSION/END FLASH. MOLD PROTRUSION/END FLASH SHALL NOT EXCEED 0.0098 in (0.25 mm) PER SIDE. BODY LENGTH DIMENSIONS ARE MAX PLASTIC BODY SIZE INCLUDING MOLD MISMATCH.
 - JEDEC SPECIFICATION NO. REF: MS-026.

51-85050 *G



Package Diagrams (continued)

Figure 10. 165-ball FBGA (15 × 17 × 1.40 mm) (0.45 Ball Diameter) Package Outline, 51-85165

NOTES:
 SOLDER PAD TYPE: SOLDER MASK DEFINED (SMD)
 PACKAGE WEIGHT: 0.60g
 JEDEC REFERENCE: MO-216 / ISSUE E
 PACKAGE CODES: BB0AA / BW0AG

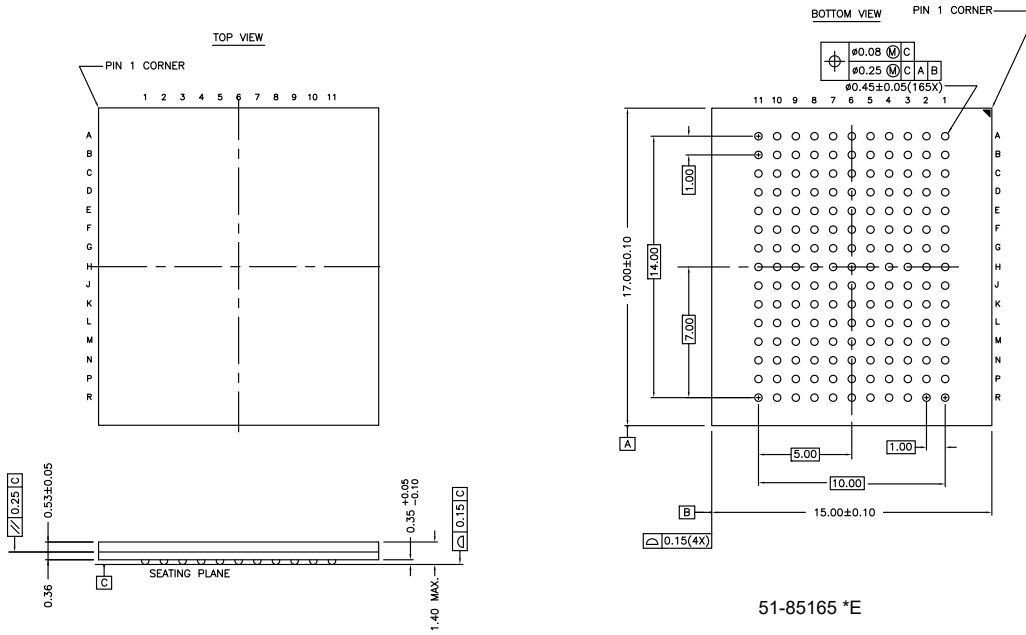

Package Diagrams (continued)

Figure 11. 209-ball FBGA (14 × 22 × 1.76 mm) BB209A Package Outline, 51-85167

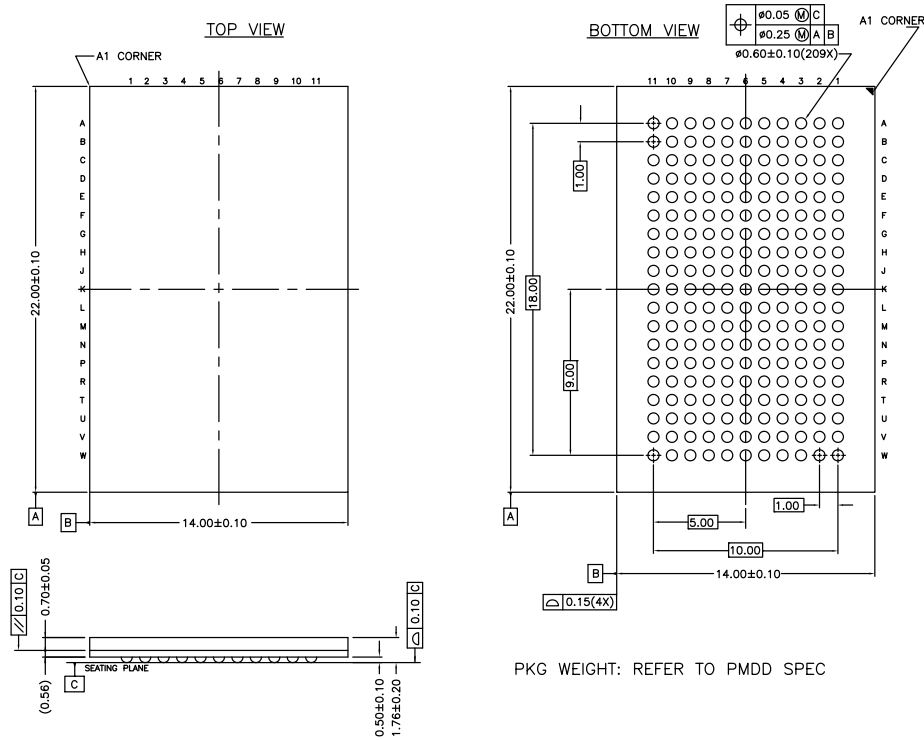

PKG WEIGHT: REFER TO PMDD SPEC

51-85167 *C



Acronyms

Acronym	Description
CMOS	Complementary Metal Oxide Semiconductor
EIA	Electronic Industries Alliance
FBGA	Fine-Pitch Ball Grid Array
I/O	Input/Output
JTAG	Joint Test Action Group
LSB	Least Significant Bit
LMBU	Logical Multi Bit Upsets
LSBU	Logical Single Bit Upsets
MSB	Most Significant Bit
\overline{OE}	Output Enable
SEL	Single Event Latch-up
SRAM	Static Random Access Memory
TAP	Test Access Port
TCK	Test Clock
TDI	Test Data-In
TDO	Test Data-Out
TMS	Test Mode Select
TQFP	Thin Quad Flat Pack
TTL	Transistor-Transistor Logic
\overline{WE}	Write Enable

Document Conventions

Units of Measure

Symbol	Unit of Measure
°C	degree Celsius
MHz	megahertz
μA	microampere
μs	microsecond
mA	milliamperere
mm	millimeter
ms	millisecond
ns	nanosecond
Ω	ohm
%	percent
pF	picofarad
V	volt
W	watt

Document History Page

Document Title: CY7C1470BV33/CY7C1472BV33/CY7C1474BV33, 72-Mbit (2M × 36/4M × 18/1M × 72) Pipelined SRAM with NoBL™ Architecture				
Document Number: 001-15031				
Revision	ECN	Orig. of Change	Submission Date	Description of Change
**	1032642	VKN / KKVTMP	05/02/2007	New data sheet.
*A	1897447	VKN / AESA	01/09/2008	Updated Electrical Characteristics (Added Note 18 and referred the same note in I _{DD} parameter).
*B	2082487	VKN	02/11/2008	Changed status from Preliminary to Final.
*C	2159486	VKN / PYRS	03/03/2008	Minor Change (Post to external web).
*D	2755901	VKN	08/25/2009	Added Neutron Soft Error Immunity . Updated Ordering Information (Updated part numbers; and modified the disclaimer for the Ordering information). Updated Package Diagrams : spec 51-85165 – Changed revision from *A to *B.
*E	2903057	VKN	04/01/2010	Updated Ordering Information (Updated part numbers). Updated Package Diagrams : spec 51-85050 – Changed revision from *B to *C. spec 51-85167 – Changed revision from ** to *A.
*F	2953769	YHB	06/16/2010	Updated Ordering Information (Updated part numbers).
*G	3052861	NJY	10/08/2010	Updated Ordering Information : Updated part numbers. Added Ordering Code Definitions .
*H	3253430	NJY	05/10/2011	Updated Ordering Information (Updated part numbers). Updated Package Diagrams spec 51-85050 – Changed revision from *C to *D. Added Acronyms and Units of Measure . Updated to new template. Completing Sunset Review.
*I	3425159	VIDB	11/11/2011	Updated Ordering Information (Updated part numbers). Updated Package Diagrams spec 51-85165 – Changed revision from *B to *D. spec 51-85167 – Changed revision from *A to *B.
*J	3593603	PRIT / GOPA	04/26/2012	Updated Ordering Information (Updated part numbers). Completing Sunset Review.
*K	4010294	PRIT	05/24/2013	Updated Package Diagrams : spec 51-85167 – Changed revision from *B to *C. Completing Sunset Review.
*L	4396527	PRIT	06/02/2014	Updated Package Diagrams : spec 51-85050 – Changed revision from *D to *E. Updated to new template. Completing Sunset Review.
*M	4575272	PRIT	11/20/2014	Updated Functional Description : Added “For a complete list of related documentation, click here .” at the end.
*N	4810937	PRIT	06/25/2015	Updated Package Diagrams : spec 51-85165 – Changed revision from *D to *E. Updated to new template. Completing Sunset Review.
*O	6058890	CNX	02/07/2018	Updated Package Diagrams : spec 51-85050 – Changed revision from *E to *G. Updated to new template.



Sales, Solutions, and Legal Information

Worldwide Sales and Design Support

Cypress maintains a worldwide network of offices, solution centers, manufacturer's representatives, and distributors. To find the office closest to you, visit us at [Cypress Locations](#).

Products

Arm® Cortex® Microcontrollers	cypress.com/arm
Automotive	cypress.com/automotive
Clocks & Buffers	cypress.com/clocks
Interface	cypress.com/interface
Internet of Things	cypress.com/iot
Memory	cypress.com/memory
Microcontrollers	cypress.com/mcu
PSoC	cypress.com/psoc
Power Management ICs	cypress.com/pmic
Touch Sensing	cypress.com/touch
USB Controllers	cypress.com/usb
Wireless Connectivity	cypress.com/wireless

PSoC® Solutions

[PSoC 1](#) | [PSoC 3](#) | [PSoC 4](#) | [PSoC 5LP](#) | [PSoC 6 MCU](#)

Cypress Developer Community

[Community](#) | [Projects](#) | [Video](#) | [Blogs](#) | [Training](#) | [Components](#)

Technical Support

cypress.com/support

© Cypress Semiconductor Corporation, 2007-2018. This document is the property of Cypress Semiconductor Corporation and its subsidiaries, including Spansion LLC ("Cypress"). This document, including any software or firmware included or referenced in this document ("Software"), is owned by Cypress under the intellectual property laws and treaties of the United States and other countries worldwide. Cypress reserves all rights under such laws and treaties and does not, except as specifically stated in this paragraph, grant any license under its patents, copyrights, trademarks, or other intellectual property rights. If the Software is not accompanied by a license agreement and you do not otherwise have a written agreement with Cypress governing the use of the Software, then Cypress hereby grants you a personal, non-exclusive, nontransferable license (without the right to sublicense) (1) under its copyright rights in the Software (a) for Software provided in source code form, to modify and reproduce the Software solely for use with Cypress hardware products, only internally within your organization, and (b) to distribute the Software in binary code form externally to end users (either directly or indirectly through resellers and distributors), solely for use on Cypress hardware product units, and (2) under those claims of Cypress's patents that are infringed by the Software (as provided by Cypress, unmodified) to make, use, distribute, and import the Software solely for use with Cypress hardware products. Any other use, reproduction, modification, translation, or compilation of the Software is prohibited.

TO THE EXTENT PERMITTED BY APPLICABLE LAW, CYPRESS MAKES NO WARRANTY OF ANY KIND, EXPRESS OR IMPLIED, WITH REGARD TO THIS DOCUMENT OR ANY SOFTWARE OR ACCOMPANYING HARDWARE, INCLUDING, BUT NOT LIMITED TO, THE IMPLIED WARRANTIES OF MERCHANTABILITY AND FITNESS FOR A PARTICULAR PURPOSE. To the extent permitted by applicable law, Cypress reserves the right to make changes to this document without further notice. Cypress does not assume any liability arising out of the application or use of any product or circuit described in this document. Any information provided in this document, including any sample design information or programming code, is provided only for reference purposes. It is the responsibility of the user of this document to properly design, program, and test the functionality and safety of any application made of this information and any resulting product. Cypress products are not designed, intended, or authorized for use as critical components in systems designed or intended for the operation of weapons, weapons systems, nuclear installations, life-support devices or systems, other medical devices or systems (including resuscitation equipment and surgical implants), pollution control or hazardous substances management, or other uses where the failure of the device or system could cause personal injury, death, or property damage ("Unintended Uses"). A critical component is any component of a device or system whose failure to perform can be reasonably expected to cause the failure of the device or system, or to affect its safety or effectiveness. Cypress is not liable, in whole or in part, and you shall and hereby do release Cypress from any claim, damage, or other liability arising from or related to all Unintended Uses of Cypress products. You shall indemnify and hold Cypress harmless from and against all claims, costs, damages, and other liabilities, including claims for personal injury or death, arising from or related to any Unintended Uses of Cypress products.

Cypress, the Cypress logo, Spansion, the Spansion logo, and combinations thereof, WICED, PSoC, CapSense, EZ-USB, F-RAM, and Traveo are trademarks or registered trademarks of Cypress in the United States and other countries. For a more complete list of Cypress trademarks, visit cypress.com. Other names and brands may be claimed as property of their respective owners.

Компания «Океан Электроники» предлагает заключение долгосрочных отношений при поставках импортных электронных компонентов на взаимовыгодных условиях!

Наши преимущества:

- Поставка оригинальных импортных электронных компонентов напрямую с производств Америки, Европы и Азии, а так же с крупнейших складов мира;
- Широкая линейка поставок активных и пассивных импортных электронных компонентов (более 30 млн. наименований);
- Поставка сложных, дефицитных, либо снятых с производства позиций;
- Оперативные сроки поставки под заказ (от 5 рабочих дней);
- Экспресс доставка в любую точку России;
- Помощь Конструкторского Отдела и консультации квалифицированных инженеров;
- Техническая поддержка проекта, помощь в подборе аналогов, поставка прототипов;
- Поставка электронных компонентов под контролем ВП;
- Система менеджмента качества сертифицирована по Международному стандарту ISO 9001;
- При необходимости вся продукция военного и аэрокосмического назначения проходит испытания и сертификацию в лаборатории (по согласованию с заказчиком);
- Поставка специализированных компонентов военного и аэрокосмического уровня качества (Xilinx, Altera, Analog Devices, Intersil, Interpoint, Microsemi, Actel, Aeroflex, Peregrine, VPT, Syfer, Eurofarad, Texas Instruments, MS Kennedy, Miteq, Cobham, E2V, MA-COM, Hittite, Mini-Circuits, General Dynamics и др.);

Компания «Океан Электроники» является официальным дистрибьютором и эксклюзивным представителем в России одного из крупнейших производителей разъемов военного и аэрокосмического назначения «JONHON», а так же официальным дистрибьютором и эксклюзивным представителем в России производителя высокотехнологичных и надежных решений для передачи СВЧ сигналов «FORSTAR».



JONHON

«JONHON» (основан в 1970 г.)

Разъемы специального, военного и аэрокосмического назначения:

(Применяются в военной, авиационной, аэрокосмической, морской, железнодорожной, горно- и нефтедобывающей отраслях промышленности)

«FORSTAR» (основан в 1998 г.)

ВЧ соединители, коаксиальные кабели,
кабельные сборки и микроволновые компоненты:

(Применяются в телекоммуникациях гражданского и специального назначения, в средствах связи, РЛС, а так же военной, авиационной и аэрокосмической отраслях промышленности).



Телефон: 8 (812) 309-75-97 (многоканальный)

Факс: 8 (812) 320-03-32

Электронная почта: ocean@oceanchips.ru

Web: <http://oceanchips.ru/>

Адрес: 198099, г. Санкт-Петербург, ул. Калинина, д. 2, корп. 4, лит. А