



MCP2003/4/3A/4A

LIN J2602 Transceiver

Features

- The MCP2003/2003A and MCP2004/2004A are compliant with Local Interconnect Network (LIN) Bus Specifications 1.3, 2.0 and 2.1 and are compliant to SAE J2602
- Support Baud Rates up to 20 Kbaud with LIN-compatible output driver
- 43V load dump protected
- Very low EMI meets stringent OEM requirements
- Very high ESD immunity:
 - >20kV on VBB (IEC 61000-4-2)
 - >14kV on LBUS (IEC 61000-4-2)
- Very high immunity to RF disturbances meets stringent OEM requirements
- Wide supply voltage, 6.0V-27.0V continuous
- Extended Temperature Range: -40 to +125°C
- Interface to PIC® MCU EUSART and standard USARTs
- LIN bus pin:
 - Internal pull-up resistor and diode
 - Protected against battery shorts
 - Protected against loss of ground
 - High current drive
- Automatic thermal shutdown
- Low-power mode:
 - Receiver monitoring bus and transmitter off, ($\cong 5 \mu\text{A}$)



Description

This device provides a bidirectional, half-duplex communication, physical interface to automotive and industrial LIN systems to meet the LIN bus specification Revision 2.1 and SAE J2602. The device is short-circuit and over-temperature protected by internal circuitry. The device has been specifically designed to operate in the automotive operating environment and will survive all specified transient conditions while meeting all of the stringent quiescent current requirements.

MCP200X family members:

- 8-pin PDIP, DFN and SOIC packages:
 - MCP2003, LIN-compatible driver, with $\overline{\text{WAKE}}$ pins, wake up on falling edge of LBUS
 - MCP2003A, LIN-compatible driver, with $\overline{\text{WAKE}}$ pins, wake up on rising edge of LBUS
 - MCP2004, LIN-compatible driver, with $\overline{\text{FAULT/TXE}}$ pins, wake up on falling edge of LBUS
 - MCP2004A, LIN-compatible driver, with $\overline{\text{FAULT/TXE}}$ pins, wake up on rising edge of LBUS

Package Types



MCP2003/4/3A/4A

MCP2003/2003A Block Diagram



MCP2004/2004A Block Diagram



1.0 DEVICE OVERVIEW

The MCP2003/4/3A/4A devices provide a physical interface between a microcontroller and a LIN bus. These devices will translate the CMOS/TTL logic levels to LIN logic level, and vice versa. It is intended for automotive and industrial applications with serial bus speeds up to 20 Kbaud.

LIN specification 2.1 requires that the transceiver of all nodes in the system is connected via the LIN pin, referenced to ground and with a maximum external termination resistance load of 510Ω from LIN bus to battery supply. The 510Ω corresponds to 1 master and 15 slave nodes.

The VREN pin can be used to drive the logic input of an external voltage regulator. This pin is high in all modes except for Power-Down mode.

1.1 External Protection

1.1.1 REVERSE BATTERY PROTECTION

An external reverse-battery-blocking diode should be used to provide polarity protection (see [Example 1-1](#)).

1.1.2 TRANSIENT VOLTAGE PROTECTION (LOAD DUMP)

An external 43V transient suppressor (TVS) diode, between VBB and ground, with a 50Ω transient protection resistor (RTP) in series with the battery supply and the VBB pin serve to protect the device from power transients (see [Example 1-1](#)) and ESD events. While this protection is optional, it is considered good engineering practice.

1.2 Internal Protection

1.2.1 ESD PROTECTION

For component-level ESD ratings, please refer to the maximum operation specifications.

1.2.2 GROUND LOSS PROTECTION

The LIN Bus specification states that the LIN pin must transition to the recessive state when ground is disconnected. Therefore, a loss of ground effectively forces the LIN line to a high-impedance level.

1.2.3 THERMAL PROTECTION

The thermal protection circuit monitors the die temperature and is able to shut down the LIN transmitter.

There are two causes for a thermal overload. A thermal shut down can be triggered by either, or both, of the following thermal overload conditions.

- LIN bus output overload
- Increase in die temperature due to increase in environment temperature

Driving the TXD and checking the RXD pin makes it possible to determine whether there is a bus contention (Rx = low, Tx = high) or a thermal overload condition (Rx = high, Tx = low). After a thermal overload event, the device will automatically recover once the die temperature has fallen below the recovery temperature threshold. See [Figure 1-1](#).

FIGURE 1-1: THERMAL SHUTDOWN STATE DIAGRAM

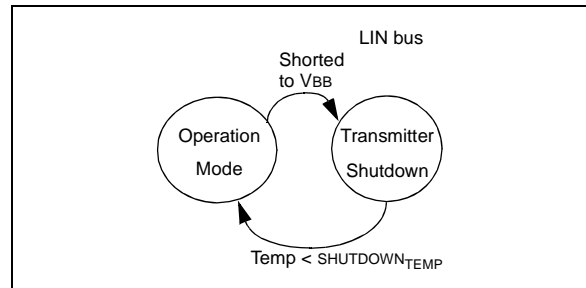

MCP2003/4/3A/4A

1.3 Modes of Operation

For an overview of all operational modes, refer to [Table 1-1](#).

1.3.1 POWER-DOWN MODE

In Power-Down mode, everything is off except the wake-up section. This is the lowest power mode. The receiver is off, thus its output is open-drain.

On CS going to a high level or a falling edge on WAKE (MCP2003/MCP2003A only), the device will enter Ready Mode as soon as internal voltage stabilizes. Refer to the AC Spec table. In addition, LIN bus activity will change the device from power-down mode to ready mode; MCP2003/4 wakes up on a falling edge of LIN bus and MCP2003/4A on a rising edge, following a low level lasting at least 20 μ S of time. Refer to [Figure 1-2](#) – [Figure 1-5](#) about remote wake up. If CS is held high as the device transitions from Power-Down to Ready mode, the device will transition to either Operation or Transmitter Off mode, depending on TXD input, as soon as internal voltages stabilize.

1.3.2 READY MODE

Upon entering the Ready mode, VREN is enabled and the receiver detect circuit is powered up. The transmitter remains disabled and the device is ready to receive data but not to transmit.

Upon VBB supply pin power-on, the device will remain in Ready mode as long as CS is low. When CS transitions high, the device will either enter Operation mode, if TXD pin is held high, or the device will enter Transmitter Off mode, if TXD pin is held low.

1.3.3 OPERATION MODE

In this mode, all internal modules are operational.

The device will go into the Power-Down mode on the falling edge of CS. For the MCP2003/4 device, a specific process should be followed to put all nodes into Power-down mode. Refer to [Section 1.6 “Enter Power-Down Mode”](#) and [Figure 1-6](#). The device will enter Transmitter Off mode in the event of a Fault condition. These include: thermal overload, bus contention and TXD timer expiration.

The MCP2004/2004A device can also enter Transmitter Off mode if the FAULT/TXE pin is pulled low. The VBB-LBUS pull-up resistor is connected only in Operation mode.

1.3.4 TRANSMITTER OFF MODE

Transmitter Off mode is reached whenever the transmitter is disabled either due to a Fault condition or pulling the nFAULT/TXE pin low on the MCP2004/2004A. The fault conditions include: thermal overload, bus contention or TXD timer expiration.

The device will go into Power-Down mode on the falling edge of CS, or return to Operation mode if all faults are resolved and the FAULT/TXE pin on the MCP2004/2004A is high.

FIGURE 1-2: OPERATIONAL MODES STATE DIAGRAM – MCP2003



FIGURE 1-3: OPERATIONAL MODES STATE DIAGRAM – MCP2003A



FIGURE 1-4: OPERATIONAL MODES STATE DIAGRAM – MCP2004



MCP2003/4/3A/4A

FIGURE 1-5: OPERATIONAL MODES STATE DIAGRAM – MCP2004A



TABLE 1-1: OVERVIEW OF OPERATIONAL MODES

State	Transmitter	Receiver	Vren	Operation	Comments
POR	OFF	OFF	OFF	Check CS, if low then Ready; If high transitions to either TOFF or Operation mode, depending on TXD (2003/A), or TXD and FAULT/TXE (2004/A).	$V_{BB} > V_{BB}(\text{min})$ and Internal Supply stable
Ready	OFF	ON	ON	If CS high level, then either Operation or TXOFF mode.	Bus Off state
Operation	ON	ON	ON	If CS low level, then Power-Down; If FAULT/TXE low level, then Transmitter Off mode.	Normal Operation mode
Power-Down	OFF	Activity Detect	OFF	On CS high level, go to READY then either Operation mode or TXOFF. MCP2003/2003A: Falling edge on WAKE will put the device into READY mode. MCP2003/MCP2004: falling edge on LIN bus will put the device into READY mode. MCP2003A/MCP2004A: rising edge on LIN bus will put the device into READY mode.	Low Power mode
Transmitter Off	OFF	ON	ON	If CS low level, then Power-Down; If FAULT/TXE and TXD high, then Operation mode	FAULT/TXE only available on MCP2004/2004A

1.4 Typical Applications

EXAMPLE 1-1: TYPICAL MCP2003/2003A APPLICATION



EXAMPLE 1-2: TYPICAL MCP2004/2004A APPLICATION



MCP2003/4/3A/4A

EXAMPLE 1-3: TYPICAL LIN NETWORK CONFIGURATION



1.5 Pin Descriptions

TABLE 1-2: PINOUT DESCRIPTIONS

Pin Name	8-Pin PDIP, SOIC	8-Pin DFN	MCP2003/2003A	MCP2004/2004A
			Normal Operation	Normal Operation
RxD	1	1	Receive Data Output (OD), HV tolerant	Receive Data Output (OD), HV tolerant
CS	2	2	Chip Select (TTL), HV tolerant	Chip Select/Local WAKE (TTL), HV tolerant
WAKE (MCP2003/2003A only) FAULT/TXE (MCP2004/2004A only)	3	3	Wake up, HV tolerant	Fault Detect Output (OD) Transmitter Enable (TTL) HV tolerant
TxD	4	4	Transmit Data Input (TTL), HV tolerant	Transmit Data Input (TTL), HV tolerant
Vss	5	5	Ground	Ground
LBUS	6	6	LIN Bus (bidirectional)	LIN Bus (bidirectional)
VBB	7	7	Battery Positive	Battery Positive
VREN	8	8	Voltage Regulator Enable Output	Voltage Regulator Enable Output
EP	—	9	Exposed Thermal Pad. Do not electrically connect or connect to Vss	Exposed Thermal Pad. Do not electrically connect or connect to Vss

Legend: TTL = TTL Input Buffer; OD = Open-Drain Output

1.5.1 RECEIVE DATA OUTPUT (RxD)

The Receive Data Output pin is an open drain (OD) output and follows the state of the LIN pin, except in Power Down mode.

1.5.2 CS (CHIP SELECT)

This is the Chip Select Input pin. An internal pull-down resistor will keep the CS pin low. This is done to ensure that no disruptive data will be present on the bus while the microcontroller is executing a Power-on Reset and an I/O initialization sequence. The pin must detect a high level to activate the transmitter. An internal Low-Pass filter, with a typical time constant of 10 μ S, prevents unwanted wake-up (or transition to Power Down mode) on glitches.

If CS = 0 when the VBB supply is turned on, the device goes to Ready mode as soon as internal voltages stabilize, and stays there as long as the CS pin is held low (0). In Ready mode, the receiver is on, and the LIN transmitter driver is off.

If CS = 1 when the VBB supply is turned on, the device will proceed to Operation mode, or TXOFF (refer to Figure 1-2 – Figure 1-5), as soon as internal voltages stabilize.

This pin may also be used as a local wake-up input (refer to [Example 1-1](#)). In this implementation, the microcontroller I/O controlling the CS should be

converted to a high-impedance input allowing the internal pull-down resistor to keep CS low. An external switch, or other source, can then wake-up both the transceiver and the microcontroller (if powered). Refer to Section [1.3 “Modes of Operation”](#), for detailed operation of CS.

Note: It is not recommended to tie CS high as this can result in the device entering Operation mode before the microcontroller is initialized and may result in unintentional LIN traffic.

1.5.3 WAKE UP INPUT ($\overline{\text{WAKE}}$)

This pin is only available on the MCP2003/2003A.

The $\overline{\text{WAKE}}$ pin has an internal 800K pull up to VBB. A falling edge on the $\overline{\text{WAKE}}$ pin causes the device to wake from Power-Down mode. Upon waking, the MCP2003/3A will enter Ready mode.

1.5.4 $\overline{\text{FAULT/TXE}}$

This pin is only available on the MCP2004/2004A. This pin is bidirectional and allows disabling of the transmitter, as well as fault reporting related to disabling the transmitter. This pin is an open-drain output, with states as defined in [TABLE 1-3: “FAULT/TXE Truth Table”](#). The transmitter is disabled whenever this pin is low ('0'), either from an internal

MCP2003/4/3A/4A

Fault condition or by an external drive. While the transmitter is disabled, the internal 30 k Ω pull-up resistor on the LBUS pin is also disconnected to reduce current.

Note: The $\overline{\text{FAULT/TXE}}$ pin is true ('0') whenever the internal circuits have detected a short or thermal excursion and have disabled the LBUS output driver.

TABLE 1-3: $\overline{\text{FAULT/TXE}}$ TRUTH TABLE

TxD In	RxD Out	LINBUS I/O	Thermal Override	$\overline{\text{FAULT/TXE}}$		Definition
				External Input	Driven Output	
L	H	VBB	OFF	H	L	FAULT, TxD driven low, LINBUS shorted to VBB (Note 1)
H	H	VBB	OFF	H	H	OK
L	L	GND	OFF	H	H	OK
H	L	GND	OFF	H	H	OK, data is being received from the LINBUS
x	x	VBB	ON	H	L	FAULT, Transceiver in thermal shutdown
x	x	VBB	x	L	x	NO FAULT, the CPU is commanding the transceiver to turn off the transmitter driver

Legend: x = don't care

Note 1: The $\overline{\text{FAULT/TXE}}$ is valid after approximately 25 μs after TxD falling edge. This is to eliminate false fault reporting during bus propagation delays.

1.5.5 TRANSMIT DATA INPUT (TxD)

The Transmit Data Input pin has an internal pull-up. The LIN pin is low (dominant) when TxD is low, and high (recessive) when TxD is high.

For extra bus security, TxD is internally forced to '1' whenever the transmitter is disabled regardless of external TxD voltage.

1.5.5.1 TxD Dominant Timeout

If TxD is driven low for longer than approximately 25 mS, the LBUS pin is switched to recessive mode and the part enters TOFF Mode. This is to prevent the LIN node from permanently driving the LIN Bus dominant. The transmitter is reenabled on TxD rising edge.

1.5.6 GROUND (Vss)

This is the Ground pin.

1.5.7 LIN BUS (LBUS)

The bidirectional LIN Bus pin (LBUS) is controlled by the TxD input. LBUS has a current limited open collector output. To reduce EMI, the edges during the signal changes are slope controlled and include corner rounding control for both falling and rising edges.

The internal LIN receiver observes the activities on the LIN bus, and matches the output signal RxD to follow the state of the LBUS pin.

1.5.7.1 Bus Dominant Timer

The Bus Dominant Timer is an internal timer that deactivates the LBUS transmitter after approximately 25 milliseconds of dominant state on the LBUS pin. The timer is reset on any recessive LBUS state.

The LIN bus transmitter will be reenabled after a recessive state on the LBUS pin as long as CS is high. Disabling can be caused by the LIN bus being externally held dominant, or by TxD being driven low. Additionally, on the MCP2004/2004A, the $\overline{\text{FAULT}}$ pin will be driven low to indicate the Transmitter Off state.

1.5.8 BATTERY (VBB)

This is the Battery Positive Supply Voltage pin.

1.5.9 VOLTAGE REGULATOR ENABLE OUTPUT (VREN)

This is the External Voltage Regulator Enable pin. Open source output is pulled high to VBB in all modes, except Power-Down.

1.5.10 EXPOSED THERMAL PAD (EP)

Do not electrically connect, or connect to Vss.

1.6 MCP2003/4 and MCP2003A/4A Difference Details

The differences between the MCP2003/4 and the MCP2003/4A devices are isolated to the wake-up functionality. The changes were implemented to make the device more robust to LIN bus conditions, outside of the normal operating conditions. The MCP2003/4 will wake-up from Power Down Mode during any LIN falling edge held low longer than 20us.

In the case where a LIN system is designed to minimize stand-by current by disconnecting all bus pull-ups resistors (including the external master pull-up resistor to VBB), the original MCP2003/4 could wake up, if the floating bus drifted to a valid low level. The MCP2003/4A revisions were modified to require a rising edge after a valid low level. This will prevent an undesired system wake-up in this scenario, while maintaining functional capability with the original version.

It should be noted that the original MCP2003/4 meets all LIN transceiver specification requirements and modules can be designed to pass all LIN system requirements. However, when all bus pull-up resistors are disconnected, the MCP2003/4 requires the module designer to write firmware to monitor the LIN Bus after any wake-up event to prevent the transceiver from automatically transitioning from Ready mode to Operational mode.

If the MCP2003/4 is placed into Operational mode, VBB-LBUS pull-up resistor is automatically connected,

which will raise the LIN bus to a recessive level; then putting the device to Power-Down mode may cause LBUS to be floating, and thus wake up all bus nodes. To prevent this, the designer should insure TXD (MCP2003) or TXE (MCP2004) is held low until valid bus activity is verified (see Figure 1-6). This will ensure the transceiver transitions from Ready mode to Transmitter Off mode, until bus activity can be verified.

In the case of valid bus activity, the transceiver can shift to Operation mode, while if there is no bus activity, the device can be again placed into Power Down. The design practices needed to accomplish this are fully detailed in **Tech Brief TB3067 - "MCP2003 Power-Down Mode and Wake-Up Handling in Case of LIN Bus Loss"** (DS93067).

The revised MCP2003/4A devices now eliminate the need for firmware to prevent system wide wake-up. The revised devices now require a longer valid bus low (see updated tBDB value in the Specification tables and **FIGURE 2-7: "MCP2003A/4A Remote Wake-up"**), which enables a rising edge detect circuit. The device will now only wake up after a rising edge, following a low longer than tBDB. While the module designer can still hold TXD (MCP2003) or TXE (MCP2004) low during wake-up, to enter Transmitter Off mode from Ready mode, it is not required to prevent an advertent system wake-up.

In addition to the longer tBDB value, the time from wake-up detect to VREN enable is shortened as documented in the Specification table.

FIGURE 1-6: MCP2003/2004 Switching Timing Diagram for the Forced Power-Down Mode Sequence



MCP2003/4/3A/4A

2.0 ELECTRICAL CHARACTERISTICS

2.1 Absolute Maximum Ratings†

V _{IN} DC Voltage on RXD, TXD, $\overline{\text{FAULT}}/\text{TXE}$, CS	-0.3 to +43V
V _{IN} DC Voltage on $\overline{\text{WAKE}}$ and VREN	-0.3 to +V _{BB}
V _{BB} Battery Voltage, continuous, non-operating (Note 1)	-0.3 to +40V
V _{BB} Battery Voltage, non-operating (LIN bus recessive) (Note 2)	-0.3 to +43V
V _{BB} Battery Voltage, transient ISO 7637 Test 1	-200V
V _{BB} Battery Voltage, transient ISO 7637 Test 2a	+150V
V _{BB} Battery Voltage, transient ISO 7637 Test 3a	-300V
V _{BB} Battery Voltage, transient ISO 7637 Test 3b	+200V
V _{LBUS} Bus Voltage, continuous	-18 to +40V
V _{LBUS} Bus Voltage, transient (Note 3)	-27 to +43V
I _{LBUS} Bus Short Circuit Current Limit	200 mA
ESD protection on LIN, V _{BB} , $\overline{\text{WAKE}}$ (IEC 61000-4-2) (Note 4)	±8 KV
ESD protection on LIN, V _{BB} (Human Body Model) (Note 5)	±8 KV
ESD protection on all other pins (Human Body Model) (Note 5)	±4 KV
ESD protection on all pins (Charge Device Model) (Note 6)	±2 KV
ESD protection on all pins (Machine Model) (Note 7)	±200V
Maximum Junction Temperature	150°C
Storage Temperature	-65 to +150°C

Note 1: LIN 2.x compliant specification.

2: SAE J2602 compliant specification.

3: ISO 7637/1 load dump compliant (t < 500 ms).

4: According to IEC 61000-4-2, 330 ohm, 150 pF and Transceiver EMC Test Specifications [2] to [4]. For $\overline{\text{WAKE}}$ pin to meet the specification, series resistor must be in place (refer to [Example 1-2](#)).

5: According to AEC-Q100-002 / JESD22-A114.

6: According to AEC-Q100-011B.

7: According to AEC-Q100-003 / JESD22-A115.

† **NOTICE:** Stresses above those listed under “Absolute Maximum Ratings” may cause permanent damage to the device. This is a stress rating only and functional operation of the device, at those or any other conditions above those indicated in the operational listings of this specification, is not implied. Exposure to maximum rating conditions for extended periods may affect device reliability.

2.2 Nomenclature used in this document

Some terms and names used in this data sheet deviate from those referred to in the LIN specifications. Equivalent values are shown below.

LIN 2.1 Name	Term used in the following tables	Definition
V _{BAT}	<i>not used</i>	ECU operating voltage
V _{SUP}	V _{BB}	Supply voltage at device pin
I _{BUS_LIM}	ISC	Current Limit of Driver
V _{BUSREC}	V _{IH} (LBUS)	Recessive state
V _{BUSDOM}	V _{IL} (LBUS)	Dominant state

2.3 DC Specifications

DC Specifications	Electrical Characteristics:					
	Unless otherwise indicated, all limits are specified for: V _{BB} = 6.0V to 30.0V T _A = -40°C to +125°C					
Parameter	Sym	Min.	Typ.	Max.	Units	Conditions
Power						
V _{BB} Quiescent Operating Current	I _{BBQ}		90	150	μA	Operating Mode, bus recessive (Note 1)
V _{BB} Transmitter-off Current	I _{BBTO}	—	75	120	μA	Transmitter off, bus recessive (Note 1)
V _{BB} Power-Down Current	I _{BBPD}	—	5	15	μA	
V _{BB} Current with V _{SS} Floating	I _{BBNOGND}	-1	—	1	mA	V _{BB} = 12V, GND to V _{BB} , V _{LIN} = 0-27V
Microcontroller Interface						
High Level Input Voltage (T _{xD} , FAULT/T _{XE})	V _{IH}	2.0	—	30	V	
Low Level Input Voltage (T _{xD} , FAULT/T _{XE})	V _{IL}	-0.3	—	0.8	V	
High Level Input Current (T _{xD} , FAULT/T _{XE})	I _{IH}	-2.5	—	—	μA	Input voltage = 4.0V
Low Level Input Current (T _{xD} , FAULT/T _{XE})	I _{IL}	-10	—	—	μA	Input voltage = 0.5V
High Level Voltage (V _{REN})	V _{HVREN}	-0.3	—	V _{BB} +0.3		
High Level Output Current (V _{REN})	I _{HVREN}	-20	—	-10	mA	Output voltage = V _{BB} -0.5V
High Level Input Voltage (CS)	V _{IH}	2.0	—	30	V	Through a current limiting resistor
Low Level Input Voltage (CS)	V _{IL}	-0.3	—	0.8	V	
High Level Input Current (CS)	I _{IH}	—	—	10.0	μA	Input voltage = 4.0V
Low Level Input Current (CS)	I _{IL}	—	—	5.0	μA	Input voltage = 0.5V
Low Level Input Voltage (WAKE)	V _{IL}	V _{BB} - 4.0V	—	—	V	
Low Level Output Voltage (R _{xD})	V _{OL}	—	—	0.4	V	I _{IN} = 2 mA
High Level Output Current (R _{xD})	I _{OH}	-1	—	-1	μA	V _{LIN} = V _{BB} , V _{RxD} = 5.5V

Note 1: Internal current limited. 2.0 ms maximum recovery time (R_{LBUS} = 0Ω, T_X = 0.4 V_{REG}, V_{LBUS} = V_{BB}).

2: Node has to sustain the current that can flow under this condition; bus must be operational under this condition.

MCP2003/4/3A/4A

2.3 DC Specifications (Continued)

DC Specifications	Electrical Characteristics: Unless otherwise indicated, all limits are specified for: $V_{BB} = 6.0V$ to $30.0V$ $T_A = -40^{\circ}C$ to $+125^{\circ}C$						
	Parameter	Sym	Min.	Typ.	Max.	Units	Conditions
Bus Interface							
High Level Input Voltage	$V_{IH}(LBUS)$	$0.6 V_{BB}$	—	—	—	V	Recessive state
Low Level Input Voltage	$V_{IL}(LBUS)$	-8	—	—	$0.4 V_{BB}$	V	Dominant state
Input Hysteresis	V_{HYS}	—	—	—	$0.175 V_{BB}$	V	$V_{IH}(LBUS) - V_{IL}(LBUS)$
Low Level Output Current	$I_{OL}(LBUS)$	40	—	—	200	mA	Output voltage = $0.1 V_{BB}$, $V_{BB} = 12V$
High Level Output Current	$I_{OH}(LBUS)$	—	—	—	20	μA	
Pull-up Current on Input	$I_{PU}(LBUS)$	5	—	—	180	μA	~30 k Ω internal pull-up @ $V_{IH}(LBUS) = 0.7 V_{BB}$
Short Circuit Current Limit	I_{SC}	50	—	—	200	mA	(Note 1)
High Level Output Voltage	$V_{OH}(LBUS)$	$0.9 V_{BB}$	—	—	V_{BB}	V	
Driver Dominant Voltage	V_{LOSUP}	—	—	—	1.2	V	$V_{BB} = 7V$, $R_{LOAD} = 500\Omega$
Driver Dominant Voltage	V_{HISUP}	—	—	—	2.0	V	$V_{BB} = 18V$, $R_{LOAD} = 500\Omega$
Driver Dominant Voltage	$V_{LOSUP-1K}$	0.6	—	—	—	V	$V_{BB} = 7V$, $R_{LOAD} = 1 k\Omega$
Driver Dominant Voltage	$V_{HISUP-1K}$	0.8	—	—	—	V	$V_{BB} = 18V$, $R_{LOAD} = 1 k\Omega$
Input Leakage Current (at the receiver during dominant bus level)	$I_{BUS_PAS_DOM}$	-1	-0.4	—	—	mA	Driver off, $V_{BUS} = 0V$, $V_{BB} = 12V$
Input Leakage Current (at the receiver during recessive bus level)	$I_{BUS_PAS_REC}$	—	12	—	20	μA	Driver off, $8V < V_{BB} < 18V$ $8V < V_{BUS} < 18V$ $V_{BUS} \geq V_{BB}$
Leakage Current (disconnected from ground)	$I_{BUS_NO_GND}$	-10	1.0	—	+10	μA	$GND_{DEVICE} = V_{BB}$, $0V < V_{BUS} < 18V$, $V_{BB} = 12V$
Leakage Current (disconnected from V_{BB})	$I_{BUS_NO_VBB}$	—	—	—	10	μA	$V_{BB} = GND$, $0 < V_{BUS} < 18V$, (Note 2)
Receiver Center Voltage	V_{BUS_CNT}	$0.475 V_{BB}$	$0.5 V_{BB}$	—	$0.525 V_{BB}$	V	$V_{BUS_CNT} = (V_{IL}(LBUS) + V_{IH}(LBUS))/2$
Slave Termination	R_{SLAVE}	20	30	—	47	k Ω	
Capacitance of Slave Node	C_{SLAVE}	—	—	—	50	pF	

Note 1: Internal current limited. 2.0 ms maximum recovery time ($R_{LBUS} = 0\Omega$, $T_X = 0.4 V_{REG}$, $V_{LBUS} = V_{BB}$).

Note 2: Node has to sustain the current that can flow under this condition; bus must be operational under this condition.

2.4 AC Specifications

AC CHARACTERISTICS		V _{BB} = 6.0V to 27.0V; T _A = -40°C to +125°C				
Parameter	Sym	Min.	Typ.	Max.	Units	Test Conditions
Bus Interface – Constant Slope Time Parameters						
Slope Rising and Falling Edges	tslope	3.5	—	22.5	μs	7.3V ≤ V _{BB} ≤ 18V
Propagation Delay of Transmitter	ttranspd	—	—	4.0	μs	ttranspd = max (ttranspdr or ttranspdf)
Propagation Delay of Receiver	trecpd	—	—	6.0	μs	trecpd = max (trecpdr or trecpdf)
Symmetry of Propagation Delay of Receiver Rising Edge w.r.t. Falling Edge	trecsym	-2.0	—	2.0	μs	trecsym = max (trecpdf – trecpdr) RRXD 2.4Ω TO VCC, CRXD 20 pF
Symmetry of Propagation Delay of Transmitter Rising Edge w.r.t. Falling Edge	ttrans-sym	-2.0	—	2.0	μs	ttranssym = max (ttranspdf - ttranspdr)
Time to Sample of FAULT/TXE for Bus Conflict Reporting	tfault	—	—	32.5	μs	tfault = max (ttranspd + tslope + trecpd)
Duty Cycle 1 @20.0 kbit/sec		.396	—	—		Cbus; Rbus conditions: 1 nF; 1 kΩ 6.8 nF; 660Ω 10 nF; 500Ω THrec(max) = 0.744 x V _{BB} , THdom(max) = 0.581 x V _{BB} , V _{BB} = 7.0V – 18V; tbit = 50 μs D1 = tbus_rec(min)/2 x tbit)
Duty Cycle 2 @20.0 kbit/sec		—	—	.581		Cbus; Rbus conditions: 1 nF; 1 kΩ 6.8 nF; 660Ω 10 nF; 500Ω THrec(max) = 0.284 x V _{BB} , THdom(max) = 0.422 x V _{BB} , V _{BB} = 7.6V – 18V; tbit = 50 μs D2 = tbus_rec(max)/2 x tbit)
Duty Cycle 3 @10.4 kbit/sec		.417	—	—		Cbus; Rbus conditions: 1 nF; 1 kΩ 6.8 nF; 660Ω 10 nF; 500Ω THrec(max) = 0.778 x V _{BB} , THdom(max) = 0.616 x V _{BB} , V _{BB} = 7.0V – 18V; tbit = 96 μs D3 = tbus_rec(min)/2 x tbit)
Duty Cycle 4 @10.4 kbit/sec		—	—	.590		Cbus; Rbus conditions: 1 nF; 1 kΩ 6.8 nF; 660Ω 10 nF; 500Ω THrec(max) = 0.251 x V _{BB} , THdom(max) = 0.389 x V _{BB} , V _{BB} = 7.6V – 18V; tbit = 96 μs D4 = tbus_rec(max)/2 x tbit)
Wake-up Timing						
Bus Activity Debounce time	tBDB	5		20	μs	MCP2003/2004
		30	70	125	μs	MCP2003A/2004A
Bus Activity to Vren on	tBACTVE	35		150	μs	MCP2003/2004
		10	30	90	μs	MCP2003A/2004A
WAKE to Vren on	tWAKE			150	μs	
Chip Select to Vren on	tCSOR	—		150	μs	Vren floating
Chip Select to Vren off	tCSPD	—		80	μs	Vren floating

MCP2003/4/3A/4A

2.5 Thermal Specifications

THERMAL CHARACTERISTICS					
Parameter	Symbol	Typ	Max	Units	Test Conditions
Recovery Temperature	$\theta_{RECOVERY}$	+140	—	°C	
Shutdown Temperature	$\theta_{SHUTDOWN}$	+150	—	°C	
Short Circuit Recovery Time	tTHERM	1.5	5.0	ms	
Thermal Package Resistances					
Thermal Resistance, 8L-DFN	θ_{JA}	35.7	—	°C/W	
Thermal Resistance, 8L-PDIP	θ_{JA}	89.3	—	°C/W	
Thermal Resistance, 8L-SOIC	θ_{JA}	149.5	—	°C/W	

Note 1: The maximum power dissipation is a function of T_{JMAX} , θ_{JA} and ambient temperature T_A . The maximum allowable power dissipation at an ambient temperature is $P_D = (T_{JMAX} - T_A) \theta_{JA}$. If this dissipation is exceeded, the die temperature will rise above 150°C and the device will go into thermal shutdown.

2.6 Typical Performance Curves

Note: The graphs and tables provided following this note are a statistical summary based on a limited number of samples and are provided for informational purposes only. The performance characteristics listed herein are not tested or guaranteed. In some graphs or tables, the data presented may be outside the specified operating range (e.g., outside specified power supply range) and therefore outside the warranted range.

Note: Unless otherwise indicated, $V_{BB} = 6.0V$ to $18.0V$, $T_A = -40^{\circ}C$ to $+125^{\circ}C$.

FIGURE 2-1: TYPICAL IBBQ



FIGURE 2-3: TYPICAL IBBTO



FIGURE 2-2: TYPICAL IBBPD



MCP2003/4/3A/4A

2.7 Timing Diagrams and Specifications

FIGURE 2-4: BUS TIMING DIAGRAM



FIGURE 2-5: CS TO VREN TIMING DIAGRAM



FIGURE 2-6: MCP2003/4 REMOTE WAKE-UP



FIGURE 2-7: MCP2003A/4A REMOTE WAKE-UP



MCP2003/4/3A/4A

3.0 PACKAGING INFORMATION

3.1 Package Marking Information

8-Lead DFN (4x4)



Examples:

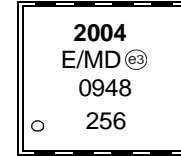

8-Lead PDIP (300 mil)



Examples:

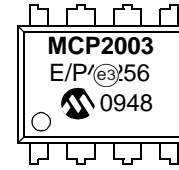
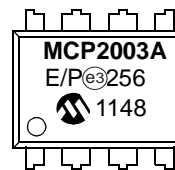

8-Lead SOIC (150 mil)

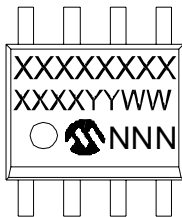

Examples:

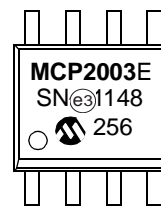

Legend:	XX...X	Customer-specific information
	Y	Year code (last digit of calendar year)
	YY	Year code (last 2 digits of calendar year)
	WW	Week code (week of January 1 is week '01')
	NNN	Alphanumeric traceability code
	(e3)	Pb-free JEDEC designator for Matte Tin (Sn)
	*	This package is Pb-free. The Pb-free JEDEC designator (e3) can be found on the outer packaging for this package.

Note: In the event the full Microchip part number cannot be marked on one line, it will be carried over to the next line, thus limiting the number of available characters for customer-specific information.

MCP2003/4/3A/4A

8-Lead Plastic Dual Flat, No Lead Package (MD) – 4x4x0.9 mm Body [DFN]

Note: For the most current package drawings, please see the Microchip Packaging Specification located at <http://www.microchip.com/packaging>



Microchip Technology Drawing C04-131E Sheet 1 of 2

MCP2003/4/3A/4A

8-Lead Plastic Dual Flat, No Lead Package (MD) – 4x4x0.9 mm Body [DFN]

Note: For the most current package drawings, please see the Microchip Packaging Specification located at <http://www.microchip.com/packaging>



Dimension Limits	Units	MILLIMETERS		
		MIN	NOM	MAX
Number of Pins	N	8		
Pitch	e	0.80 BSC		
Overall Height	A	0.80	0.90	1.00
Standoff	A1	0.00	0.02	0.05
Contact Thickness	A3	0.20 REF		
Overall Length	D	4.00 BSC		
Exposed Pad Width	E2	2.60	2.70	2.80
Overall Width	E	4.00 BSC		
Exposed Pad Length	D2	3.40	3.50	3.60
Contact Width	b	0.25	0.30	0.35
Contact Length	L	0.30	0.40	0.50
Contact-to-Exposed Pad	K	0.20	-	-

Notes:

1. Pin 1 visual index feature may vary, but must be located within the hatched area.
2. Package may have one or more exposed tie bars at ends.
3. Package is saw singulated
4. Dimensioning and tolerancing per ASME Y14.5M
BSC: Basic Dimension. Theoretically exact value shown without tolerances.
REF: Reference Dimension, usually without tolerance, for information purposes only.

Microchip Technology Drawing C04-131E Sheet 2 of 2

8-Lead Plastic Dual Flat, No Lead Package (MD) - 4x4x0.9 mm Body [DFN]

Note: For the most current package drawings, please see the Microchip Packaging Specification located at <http://www.microchip.com/packaging>

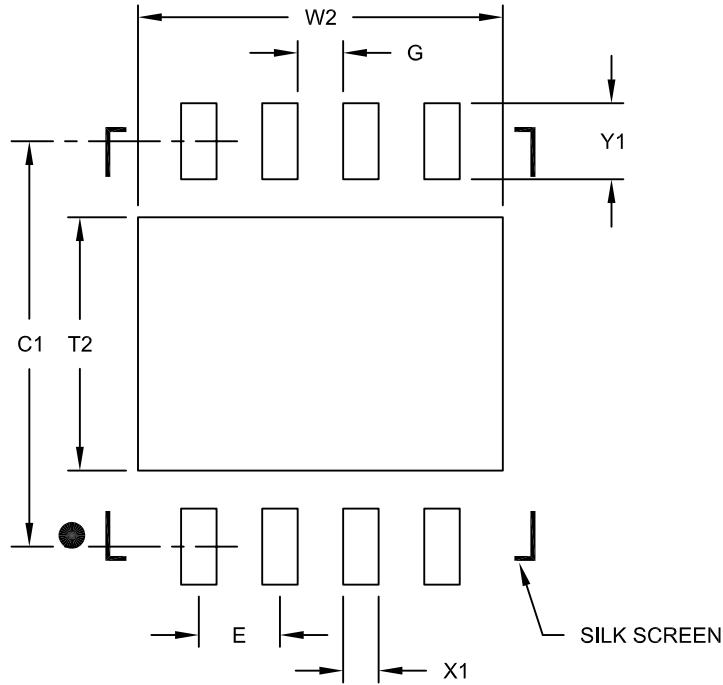

RECOMMENDED LAND PATTERN

Dimension Limits	Units	MILLIMETERS		
		MIN	NOM	MAX
Contact Pitch	E	0.80 BSC		
Optional Center Pad Width	W2			3.60
Optional Center Pad Length	T2			2.50
Contact Pad Spacing	C1		4.00	
Contact Pad Width (X8)	X1			0.35
Contact Pad Length (X8)	Y1			0.75
Distance Between Pads	G	0.45		

Notes:

1. Dimensioning and tolerancing per ASME Y14.5M

BSC: Basic Dimension. Theoretically exact value shown without tolerances.

Microchip Technology Drawing No. C04-2131C

MCP2003/4/3A/4A

8-Lead Plastic Dual In-Line (P) – 300 mil Body [PDIP]

Note: For the most current package drawings, please see the Microchip Packaging Specification located at <http://www.microchip.com/packageing>



Dimension Limits	Units	INCHES		
		MIN	NOM	MAX
Number of Pins	N	8		
Pitch	e	.100 BSC		
Top to Seating Plane	A	–	–	.210
Molded Package Thickness	A2	.115	.130	.195
Base to Seating Plane	A1	.015	–	–
Shoulder to Shoulder Width	E	.290	.310	.325
Molded Package Width	E1	.240	.250	.280
Overall Length	D	.348	.365	.400
Tip to Seating Plane	L	.115	.130	.150
Lead Thickness	c	.008	.010	.015
Upper Lead Width	b1	.040	.060	.070
Lower Lead Width	b	.014	.018	.022
Overall Row Spacing §	eB	–	–	.430

Notes:

- Pin 1 visual index feature may vary, but must be located with the hatched area.
- § Significant Characteristic.
- Dimensions D and E1 do not include mold flash or protrusions. Mold flash or protrusions shall not exceed .010" per side.
- Dimensioning and tolerancing per ASME Y14.5M.
BSC: Basic Dimension. Theoretically exact value shown without tolerances.

Microchip Technology Drawing C04-018B

8-Lead Plastic Small Outline (SN) - Narrow, 3.90 mm Body [SOIC]

Note: For the most current package drawings, please see the Microchip Packaging Specification located at <http://www.microchip.com/packaging>



Microchip Technology Drawing No. C04-057C Sheet 1 of 2

MCP2003/4/3A/4A

8-Lead Plastic Small Outline (SN) - Narrow, 3.90 mm Body [SOIC]

Note: For the most current package drawings, please see the Microchip Packaging Specification located at <http://www.microchip.com/packaging>



Dimension Limits	Units	MILLIMETERS		
		MIN	NOM	MAX
Number of Pins	N	8		
Pitch	e	1.27 BSC		
Overall Height	A	-	-	1.75
Molded Package Thickness	A2	1.25	-	-
Standoff §	A1	0.10	-	0.25
Overall Width	E	6.00 BSC		
Molded Package Width	E1	3.90 BSC		
Overall Length	D	4.90 BSC		
Chamfer (Optional)	h	0.25	-	0.50
Foot Length	L	0.40	-	1.27
Footprint	L1	1.04 REF		
Foot Angle	φ	0°	-	8°
Lead Thickness	c	0.17	-	0.25
Lead Width	b	0.31	-	0.51
Mold Draft Angle Top	α	5°	-	15°
Mold Draft Angle Bottom	β	5°	-	15°

Notes:

1. Pin 1 visual index feature may vary, but must be located within the hatched area.
2. § Significant Characteristic
3. Dimensions D and E1 do not include mold flash or protrusions. Mold flash or protrusions shall not exceed 0.15mm per side.
4. Dimensioning and tolerancing per ASME Y14.5M

BSC: Basic Dimension. Theoretically exact value shown without tolerances.

REF: Reference Dimension, usually without tolerance, for information purposes only.

Microchip Technology Drawing No. C04-057C Sheet 2 of 2

8-Lead Plastic Small Outline (SN) – Narrow, 3.90 mm Body [SOIC]

Note: For the most current package drawings, please see the Microchip Packaging Specification located at <http://www.microchip.com/packaging>



RECOMMENDED LAND PATTERN

Dimension Limits	Units	MILLIMETERS		
		MIN	NOM	MAX
Contact Pitch	E	1.27 BSC		
Contact Pad Spacing	C		5.40	
Contact Pad Width (X8)	X1			0.60
Contact Pad Length (X8)	Y1			1.55

Notes:

1. Dimensioning and tolerancing per ASME Y14.5M

BSC: Basic Dimension. Theoretically exact value shown without tolerances.

Microchip Technology Drawing No. C04-2057A

MCP2003/4/3A/4A

NOTES:

APPENDIX A: REVISION HISTORY

Revision D (December 2011)

The following is the list of modifications:

1. Added the MCP2003A and MCP2004A devices and related information throughout the document.
2. Updated Figures 1.2, 1.3, 1.4, 1.5, 2.6, 2.7.

Revision C (August 2010)

The following is the list of modifications:

1. Updated all references of Sleep mode to Power-Down mode, and updated the Max. parameter for Duty Cycle 2 in [Section 2.4 "AC Specifications"](#).

Revision B (July 2010)

The following is the list of modifications:

1. Added [Section 2.2 "Nomenclature used in this document"](#), and added the "Capacitance of Slave Node" parameter to [Section 2.3 "DC Specifications"](#).

Revision A (March 2010)

- Original Release of this Document.

MCP2003/4/3A/4A

NOTES:

PRODUCT IDENTIFICATION SYSTEM

To order or obtain information, e.g., on pricing or delivery, refer to the factory or the listed sales office.

<u>PART NO.</u>	<u>X</u>	<u>/XX</u>	Examples:
Device	Temperature Range	Package	
Device:	MCP2003:	LIN Transceiver, with $\overline{\text{WAKE}}$ pins, wake up on falling edge of LBUS	a) MCP2003A-E/MD: Extended Temperature, 8L-DFN package
	MCP2003T:	LIN Transceiver, with $\overline{\text{WAKE}}$ pins, wake up on falling edge of LBUS (Tape and Reel) (DFN and SOIC)	b) MCP2003A-E/P: Extended Temperature, 8L-PDIP package
	MCP2003A:	LIN Transceiver, with $\overline{\text{WAKE}}$ pins, wake up on rising edge of LBUS	c) MCP2003A-E/SN: Extended Temperature, 8L-SOIC package
	MCP2003AT:	LIN Transceiver, with $\overline{\text{WAKE}}$ pins, wake up on rising edge of LBUS (Tape and Reel) (DFN and SOIC)	d) MCP2003AT-E/MD: Tape and Reel, Extended Temperature, 8L-DFN package
	MCP2004:	LIN Transceiver with $\overline{\text{FAULT/TXE}}$ pins, wake up on falling edge of LBUS	e) MCP2003AT-E/SN: Tape and Reel, Extended Temperature, 8L-SOIC package
	MCP2004T:	LIN Transceiver with $\overline{\text{FAULT/TXE}}$ pins, wake up on falling edge of LBUS (Tape and Reel) (DFN and SOIC)	a) MCP2004-E/MD: Extended Temperature, 8L-DFN package
	MCP2004A:	LIN Transceiver with $\overline{\text{FAULT/TXE}}$ pins, wake up on rising edge of LBUS	b) MCP2004-E/P: Extended Temperature, 8L-PDIP package
	MCP2004AT:	LIN Transceiver with $\overline{\text{FAULT/TXE}}$ pins, wake up on rising edge of LBUS (Tape and Reel) (DFN and SOIC)	c) MCP2004A-E/SN: Extended Temperature, 8L-SOIC package
			d) MCP2004AT-E/MD: Tape and Reel, Extended Temperature, 8L-DFN package
			e) MCP2004AT-E/SN: Tape and Reel, Extended Temperature, 8L-SOIC package
Temperature Range:	E	= -40°C to +125°C	
Package:	MD	= Plastic Micro Small Outline (4x4), 8-lead	
	P	= Plastic DIP (300 mil Body), 8-lead, 14-lead	
	SN	= Plastic SOIC, (150 mil Body), 8-lead	

MCP2003/4/3A/4A

NOTES:

Note the following details of the code protection feature on Microchip devices:

- Microchip products meet the specification contained in their particular Microchip Data Sheet.
- Microchip believes that its family of products is one of the most secure families of its kind on the market today, when used in the intended manner and under normal conditions.
- There are dishonest and possibly illegal methods used to breach the code protection feature. All of these methods, to our knowledge, require using the Microchip products in a manner outside the operating specifications contained in Microchip's Data Sheets. Most likely, the person doing so is engaged in theft of intellectual property.
- Microchip is willing to work with the customer who is concerned about the integrity of their code.
- Neither Microchip nor any other semiconductor manufacturer can guarantee the security of their code. Code protection does not mean that we are guaranteeing the product as “unbreakable.”

Code protection is constantly evolving. We at Microchip are committed to continuously improving the code protection features of our products. Attempts to break Microchip's code protection feature may be a violation of the Digital Millennium Copyright Act. If such acts allow unauthorized access to your software or other copyrighted work, you may have a right to sue for relief under that Act.

Information contained in this publication regarding device applications and the like is provided only for your convenience and may be superseded by updates. It is your responsibility to ensure that your application meets with your specifications. MICROCHIP MAKES NO REPRESENTATIONS OR WARRANTIES OF ANY KIND WHETHER EXPRESS OR IMPLIED, WRITTEN OR ORAL, STATUTORY OR OTHERWISE, RELATED TO THE INFORMATION, INCLUDING BUT NOT LIMITED TO ITS CONDITION, QUALITY, PERFORMANCE, MERCHANTABILITY OR FITNESS FOR PURPOSE. Microchip disclaims all liability arising from this information and its use. Use of Microchip devices in life support and/or safety applications is entirely at the buyer's risk, and the buyer agrees to defend, indemnify and hold harmless Microchip from any and all damages, claims, suits, or expenses resulting from such use. No licenses are conveyed, implicitly or otherwise, under any Microchip intellectual property rights.

Trademarks

The Microchip name and logo, the Microchip logo, dsPIC, KEELOQ, KEELOQ logo, MPLAB, PIC, PICmicro, PICSTART, PIC³² logo, rfPIC and UNI/O are registered trademarks of Microchip Technology Incorporated in the U.S.A. and other countries.

FilterLab, Hampshire, HI-TECH C, Linear Active Thermistor, MXDEV, MXLAB, SEEVAL and The Embedded Control Solutions Company are registered trademarks of Microchip Technology Incorporated in the U.S.A.

Analog-for-the-Digital Age, Application Maestro, chipKIT, chipKIT logo, CodeGuard, dsPICDEM, dsPICDEM.net, dsPICworks, dsSPEAK, ECAN, ECONOMONITOR, FanSense, HI-TIDE, In-Circuit Serial Programming, ICSP, Mindi, MiWi, MPASM, MPLAB Certified logo, MPLIB, MPLINK, mTouch, Omniscient Code Generation, PICC, PICC-18, PICDEM, PICDEM.net, PICKit, PICtail, REAL ICE, rfLAB, Select Mode, Total Endurance, TSHARC, UniWinDriver, WiperLock and ZENA are trademarks of Microchip Technology Incorporated in the U.S.A. and other countries.

SQTP is a service mark of Microchip Technology Incorporated in the U.S.A.

All other trademarks mentioned herein are property of their respective companies.

© 2010-2011, Microchip Technology Incorporated, Printed in the U.S.A., All Rights Reserved.

 Printed on recycled paper.

ISBN: 978-1-61341-920-5

Microchip received ISO/TS-16949:2009 certification for its worldwide headquarters, design and wafer fabrication facilities in Chandler and Tempe, Arizona; Gresham, Oregon and design centers in California and India. The Company's quality system processes and procedures are for its PIC[®] MCUs and dsPIC[®] DSCs, KEELOQ[®] code hopping devices, Serial EEPROMs, microperipherals, nonvolatile memory and analog products. In addition, Microchip's quality system for the design and manufacture of development systems is ISO 9001:2000 certified.

QUALITY MANAGEMENT SYSTEM
CERTIFIED BY DNV
== ISO/TS 16949:2009 ==



MICROCHIP

Worldwide Sales and Service

AMERICAS

Corporate Office
2355 West Chandler Blvd.
Chandler, AZ 85224-6199
Tel: 480-792-7200
Fax: 480-792-7277
Technical Support:
<http://www.microchip.com/support>
Web Address:
www.microchip.com

Atlanta
Duluth, GA
Tel: 678-957-9614
Fax: 678-957-1455

Boston
Westborough, MA
Tel: 774-760-0087
Fax: 774-760-0088

Chicago
Itasca, IL
Tel: 630-285-0071
Fax: 630-285-0075

Cleveland
Independence, OH
Tel: 216-447-0464
Fax: 216-447-0643

Dallas
Addison, TX
Tel: 972-818-7423
Fax: 972-818-2924

Detroit
Farmington Hills, MI
Tel: 248-538-2250
Fax: 248-538-2260

Indianapolis
Noblesville, IN
Tel: 317-773-8323
Fax: 317-773-5453

Los Angeles
Mission Viejo, CA
Tel: 949-462-9523
Fax: 949-462-9608

Santa Clara
Santa Clara, CA
Tel: 408-961-6444
Fax: 408-961-6445

Toronto
Mississauga, Ontario,
Canada
Tel: 905-673-0699
Fax: 905-673-6509

ASIA/PACIFIC

Asia Pacific Office
Suites 3707-14, 37th Floor
Tower 6, The Gateway
Harbour City, Kowloon
Hong Kong
Tel: 852-2401-1200
Fax: 852-2401-3431

Australia - Sydney
Tel: 61-2-9868-6733
Fax: 61-2-9868-6755

China - Beijing
Tel: 86-10-8569-7000
Fax: 86-10-8528-2104

China - Chengdu
Tel: 86-28-8665-5511
Fax: 86-28-8665-7889

China - Chongqing
Tel: 86-23-8980-9588
Fax: 86-23-8980-9500

China - Hangzhou
Tel: 86-571-2819-3187
Fax: 86-571-2819-3189

China - Hong Kong SAR
Tel: 852-2401-1200
Fax: 852-2401-3431

China - Nanjing
Tel: 86-25-8473-2460
Fax: 86-25-8473-2470

China - Qingdao
Tel: 86-532-8502-7355
Fax: 86-532-8502-7205

China - Shanghai
Tel: 86-21-5407-5533
Fax: 86-21-5407-5066

China - Shenyang
Tel: 86-24-2334-2829
Fax: 86-24-2334-2393

China - Shenzhen
Tel: 86-755-8203-2660
Fax: 86-755-8203-1760

China - Wuhan
Tel: 86-27-5980-5300
Fax: 86-27-5980-5118

China - Xian
Tel: 86-29-8833-7252
Fax: 86-29-8833-7256

China - Xiamen
Tel: 86-592-2388138
Fax: 86-592-2388130

China - Zhuhai
Tel: 86-756-3210040
Fax: 86-756-3210049

ASIA/PACIFIC

India - Bangalore
Tel: 91-80-3090-4444
Fax: 91-80-3090-4123

India - New Delhi
Tel: 91-11-4160-8631
Fax: 91-11-4160-8632

India - Pune
Tel: 91-20-2566-1512
Fax: 91-20-2566-1513

Japan - Osaka
Tel: 81-66-152-7160
Fax: 81-66-152-9310

Japan - Yokohama
Tel: 81-45-471-6166
Fax: 81-45-471-6122

Korea - Daegu
Tel: 82-53-744-4301
Fax: 82-53-744-4302

Korea - Seoul
Tel: 82-2-554-7200
Fax: 82-2-558-5932 or
82-2-558-5934

Malaysia - Kuala Lumpur
Tel: 60-3-6201-9857
Fax: 60-3-6201-9859

Malaysia - Penang
Tel: 60-4-227-8870
Fax: 60-4-227-4068

Philippines - Manila
Tel: 63-2-634-9065
Fax: 63-2-634-9069

Singapore
Tel: 65-6334-8870
Fax: 65-6334-8850

Taiwan - Hsin Chu
Tel: 886-3-5778-366
Fax: 886-3-5770-955

Taiwan - Kaohsiung
Tel: 886-7-536-4818
Fax: 886-7-330-9305

Taiwan - Taipei
Tel: 886-2-2500-6610
Fax: 886-2-2508-0102

Thailand - Bangkok
Tel: 66-2-694-1351
Fax: 66-2-694-1350

EUROPE

Austria - Wels
Tel: 43-7242-2244-39
Fax: 43-7242-2244-393

Denmark - Copenhagen
Tel: 45-4450-2828
Fax: 45-4485-2829

France - Paris
Tel: 33-1-69-53-63-20
Fax: 33-1-69-30-90-79

Germany - Munich
Tel: 49-89-627-144-0
Fax: 49-89-627-144-44

Italy - Milan
Tel: 39-0331-742611
Fax: 39-0331-466781

Netherlands - Drunen
Tel: 31-416-690399
Fax: 31-416-690340

Spain - Madrid
Tel: 34-91-708-08-90
Fax: 34-91-708-08-91

UK - Wokingham
Tel: 44-118-921-5869
Fax: 44-118-921-5820

11/29/11

Компания «Океан Электроники» предлагает заключение долгосрочных отношений при поставках импортных электронных компонентов на взаимовыгодных условиях!

Наши преимущества:

- Поставка оригинальных импортных электронных компонентов напрямую с производств Америки, Европы и Азии, а так же с крупнейших складов мира;
- Широкая линейка поставок активных и пассивных импортных электронных компонентов (более 30 млн. наименований);
- Поставка сложных, дефицитных, либо снятых с производства позиций;
- Оперативные сроки поставки под заказ (от 5 рабочих дней);
- Экспресс доставка в любую точку России;
- Помощь Конструкторского Отдела и консультации квалифицированных инженеров;
- Техническая поддержка проекта, помощь в подборе аналогов, поставка прототипов;
- Поставка электронных компонентов под контролем ВП;
- Система менеджмента качества сертифицирована по Международному стандарту ISO 9001;
- При необходимости вся продукция военного и аэрокосмического назначения проходит испытания и сертификацию в лаборатории (по согласованию с заказчиком);
- Поставка специализированных компонентов военного и аэрокосмического уровня качества (Xilinx, Altera, Analog Devices, Intersil, Interpoint, Microsemi, Actel, Aeroflex, Peregrine, VPT, Syfer, Eurofarad, Texas Instruments, MS Kennedy, Miteq, Cobham, E2V, MA-COM, Hittite, Mini-Circuits, General Dynamics и др.);

Компания «Океан Электроники» является официальным дистрибьютором и эксклюзивным представителем в России одного из крупнейших производителей разъемов военного и аэрокосмического назначения «JONHON», а так же официальным дистрибьютором и эксклюзивным представителем в России производителя высокотехнологичных и надежных решений для передачи СВЧ сигналов «FORSTAR».



JONHON

«JONHON» (основан в 1970 г.)

Разъемы специального, военного и аэрокосмического назначения:

(Применяются в военной, авиационной, аэрокосмической, морской, железнодорожной, горно- и нефтедобывающей отраслях промышленности)

«FORSTAR» (основан в 1998 г.)

ВЧ соединители, коаксиальные кабели,
кабельные сборки и микроволновые компоненты:

(Применяются в телекоммуникациях гражданского и специального назначения, в средствах связи, РЛС, а так же военной, авиационной и аэрокосмической отраслях промышленности).



Телефон: 8 (812) 309-75-97 (многоканальный)

Факс: 8 (812) 320-03-32

Электронная почта: ocean@oceanchips.ru

Web: <http://oceanchips.ru/>

Адрес: 198099, г. Санкт-Петербург, ул. Калинина, д. 2, корп. 4, лит. А