

FEATURES

Conversion gain: 10 dB typical
Image rejection: 30 dBc typical
Noise figure: 6 dB typical
Input power for 1 dB compression (P1dB): -10 dBm typical
Input third-order intercept (IP3): -2 dBm typical
Input second-order intercept (IP2): 25 dBm typical
6× LO leakage at RFIN: -40 dBm typical
Radio frequency (RF) return loss: 10 dB typical
Local oscillator (LO) return loss: 20 dB typical
Die size: 3.599 mm × 2.199 mm × 0.05 mm

APPLICATIONS

E-band communication systems
High capacity wireless backhauls
Test and measurement

GENERAL DESCRIPTION

The **HMC7587** is an integrated, E-band gallium arsenide (GaAs), monolithic microwave integrated circuit (MMIC), in-phase/quadrature (I/Q) downconverter chip that operates from 81 GHz to 86 GHz. The **HMC7587** provides a small signal conversion gain of 10 dB with 30 dBc of image rejection across the frequency band. The device uses a low noise amplifier followed by an image rejection mixer that is driven by a 6× multiplier.

The image rejection mixer eliminates the need for a filter following the low noise amplifier. Differential I and Q mixer outputs are provided for direct conversion applications. Alternatively, the outputs can be combined using an external 90° hybrid and two external 180° hybrids to allow for single-sideband applications. All data includes the effect of a 3 mil wide ribbon wedge bond on the RF port, and a 1 mil gold wire wedge bond on the intermediate frequency (IF) ports.

FUNCTIONAL BLOCK DIAGRAM

Figure 1.

Rev. A

[Document Feedback](#)

Information furnished by Analog Devices is believed to be accurate and reliable. However, no responsibility is assumed by Analog Devices for its use, nor for any infringements of patents or other rights of third parties that may result from its use. Specifications subject to change without notice. No license is granted by implication or otherwise under any patent or patent rights of Analog Devices. Trademarks and registered trademarks are the property of their respective owners.

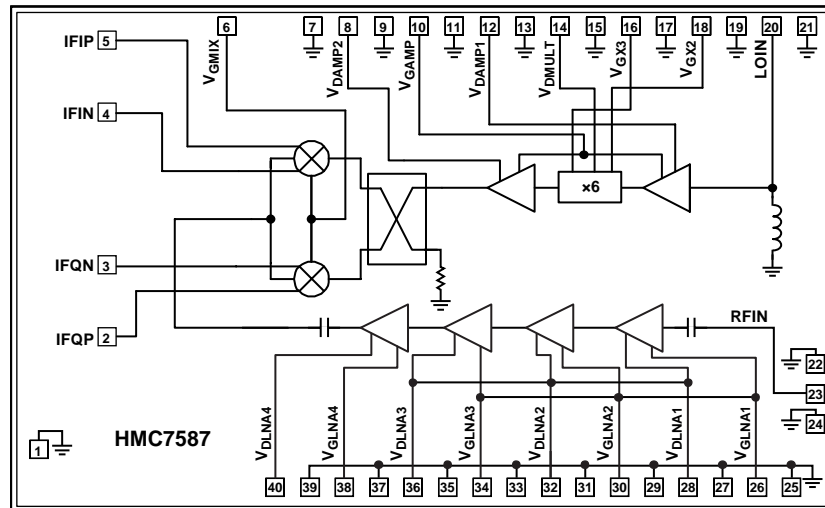
One Technology Way, P.O. Box 9106, Norwood, MA 02062-9106, U.S.A.
 Tel: 781.329.4700 ©2016 Analog Devices, Inc. All rights reserved.
[Technical Support](#) www.analog.com

TABLE OF CONTENTS

Features	1	Spurious Performance with Upper Sideband Selected, IF = 500 MHz	44
Applications	1	Spurious Performance with Upper Sideband Selected, IF = 1000 MHz	45
General Description	1	Spurious Performance with Upper Sideband Selected, IF = 2000 MHz	46
Functional Block Diagram	1	Spurious Performance with Lower Sideband Selected, IF = 500 MHz	47
Revision History	2	Spurious Performance with Lower Sideband Selected, IF = 1000 MHz	48
Specifications	3	Spurious Performance with Lower Sideband Selected, IF = 2000 MHz	49
Absolute Maximum Ratings	4	Theory of Operation	50
Thermal Resistance	4	Applications Information	51
ESD Caution	4	Biasing Sequence	51
Pin Configuration and Function Descriptions	5	Image Rejection Downconversion	51
Interface Schematics	6	Zero IF Direct Conversion	52
Typical Performance Characteristics	7	Assembly Diagram	53
Upper Sideband Selected, IF = 500 MHz	7	Mounting and Bonding Techniques for Millimeterwave GaAs MMICs	54
Upper Sideband Selected, IF = 1000 MHz	13	Handling Precautions	54
Upper Sideband Selected, IF = 2000 MHz	18	Mounting	54
Noise Figure Performance with Upper Sideband Selected ...	23	Wire Bonding	54
Amplitude Balance Performance with Upper Sideband Selected	24	Outline Dimensions	55
Phase Balance Performance with Upper Sideband Selected	25	Ordering Guide	55
Lower Sideband Selected, IF = 500 MHz	26		
Lower Sideband Selected, IF = 1000 MHz	31		
Lower Sideband Selected, IF = 2000 MHz	36		
Noise Figure Performance with Lower Sideband Selected ...	41		
Amplitude Balance Performance with Lower Sideband Selected	42		
Phase Balance Performance with Lower Sideband Selected.	43		

REVISION HISTORY

3/16—Revision A: Initial Version

SPECIFICATIONS

$T_A = 25^\circ\text{C}$, $IF = 500\text{ MHz}$, $V_{GMIX} = -1\text{ V}$, $V_{DAMPx} = 4\text{ V}$, $V_{DMULT} = 1.5\text{ V}$, voltage on the V_{DLNAX} pins (V_{DLNA}) = 3 V , $LO = 2\text{ dBm}$, upper sideband selected. Measurements performed as a downconverter with external 90° and 180° hybrids at the IF ports, unless otherwise noted.

Table 1.

Parameter	Test Conditions/Comments	Min	Typ	Max	Unit
OPERATING CONDITIONS					
RF Frequency Range		81		86	GHz
LO Frequency Range		11.83		14.33	GHz
IF Frequency Range		0		10	GHz
LO Drive Range		2		8	dBm
PERFORMANCE					
Conversion Gain		8	10		dB
Image Rejection		20	30		dBc
Input Third-Order Intercept (IP3)			-2		dBm
Input Second-Order Intercept (IP2)			25		dBm
Input Power for 1 dB Compression (P1dB)			-10		dBm
6× LO Leakage at RF Input (RFIN)			-40		dBm
1× LO Leakage at IF Output (IFOUT)			-50		dBm
Amplitude Balance ¹			-0.5		dB
Phase Balance ¹			±4		Degrees
Noise Figure			6		dB
RF Return Loss	LO = 2 dBm at 12 GHz		10		dB
LO Return Loss			20		dB
IF Return Loss ¹			25		dB
POWER SUPPLY					
Supply Current					
I_{DAMP}^2	Under LO drive		175		mA
I_{DMULT}^3			80		mA
I_{DLNA}^4			50		mA

¹ These measurements were performed without external hybrids at the IF ports.

² Adjust V_{GAMP} between -2 V and 0 V to achieve the total quiescent current, $I_{DAMP} = I_{DAMP1} + I_{DAMP2} = 175\text{ mA}$.

³ Adjust V_{GX2} and V_{GX3} between -2 V and 0 V to achieve the quiescent current, $I_{DMULT} = 1\text{ mA}$ to 2 mA . See the Applications Information section for more information.

⁴ Adjust V_{GLNAX} between -2 V and 0 V to achieve the quiescent current, $I_{DLNA1} + I_{DLNA2} + I_{DLNA3} + I_{DLNA4} = 50\text{ mA}$.

ABSOLUTE MAXIMUM RATINGS

Table 2.

Parameter	Rating
Drain Bias Voltage	
V_{DAMP1}, V_{DAMP2}	4.5 V
V_{DMULT}	3 V
$V_{DLNA1}, V_{DLNA2}, V_{DLNA3}, V_{DLNA4}$	4.5 V
Gate Bias Voltage	
V_{GAMP}	-3 V to 0 V
V_{GX2}, V_{GX3}	-3 V to 0 V
$V_{GLNA1}, V_{GLNA2}, V_{GLNA3}, V_{GLNA4}$	-3 V to 0 V
V_{GMIX}	-3 V to 0 V
LO Input Power	10 dBm
Maximum Junction Temperature (to Maintain 1 Million Hours Mean Time to Failure (MTTF))	175°C
Storage Temperature Range	-65°C to +150°C
Operating Temperature Range	-55°C to +85°C

Stresses at or above those listed under Absolute Maximum Ratings may cause permanent damage to the product. This is a stress rating only; functional operation of the product at these or any other conditions above those indicated in the operational section of this specification is not implied. Operation beyond the maximum operating conditions for extended periods may affect product reliability.

THERMAL RESISTANCE

Table 3. Thermal Resistance

Package Type	θ_{JC}^1	Unit
40-Pad Bare Die [CHIP]	61.7	°C/W

¹ Based on ABLEBOND® 84-1LMIT as die attach epoxy with thermal conductivity of 3.6 W/mK.

ESD CAUTION



ESD (electrostatic discharge) sensitive device. Charged devices and circuit boards can discharge without detection. Although this product features patented or proprietary protection circuitry, damage may occur on devices subjected to high energy ESD. Therefore, proper ESD precautions should be taken to avoid performance degradation or loss of functionality.

PIN CONFIGURATION AND FUNCTION DESCRIPTIONS

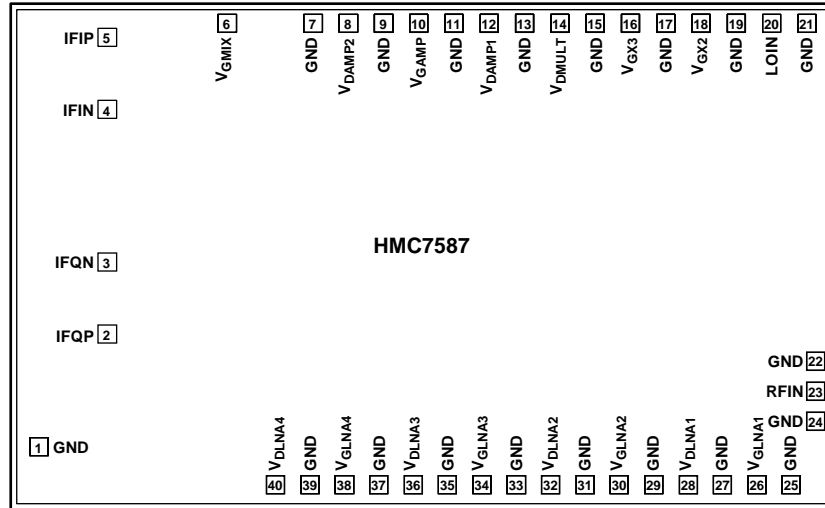

Figure 2. Pad Configuration

Table 4. Pad Function Descriptions

Pad No.	Mnemonic	Description
1, 7, 9, 11, 13, 15, 17, 19, 21, 22, 24, 25, 27, 29, 31, 33, 35, 37, 39	GND	Ground Connect (See Figure 3).
2, 3	IFQP, IFQN	Positive and Negative IF Q Inputs. These pads are dc-coupled. When operation to dc is not required, block these pads externally using a series capacitor with a value chosen to pass the necessary frequency range. For operation to dc, these pads must not source or sink more than 3 mA of current or die malfunction and possible die failure may result (see Figure 4).
4, 5	IFIN, IFIP	Negative and Positive IF I Inputs. These pads are dc-coupled. When operation to dc is not required, block these pads externally using a series capacitor with a value chosen to pass the necessary frequency range. For operation to dc, these pads must not source or sink more than 3 mA of current or die malfunction and possible die failure may result (see Figure 4).
6	VG MIX	Gate Voltage for the FET Mixer (See Figure 5). External bypass capacitors of 120 pF, 0.01 μF, and 4.7 μF are recommended (see Figure 211).
8, 12	VDAMP2, VDAMP1	Power Supply Voltage for the First and the Second Stage LO Amplifier (See Figure 5). External bypass capacitors of 120 pF, 0.01 μF, and 4.7 μF are recommended (see Figure 211).
10	VGAMP	Gate Voltage for the First and the Second Stage LO Amplifier (See Figure 5). External bypass capacitors of 120 pF, 0.01 μF, and 4.7 μF are recommended (see Figure 211).
14	VDMULT	Power Supply Voltage for the LO Multiplier (See Figure 5). External bypass capacitors of 120 pF, 0.01 μF, and 4.7 μF are recommended (see Figure 211).
16, 18	VGX3, VGX2	Gate Voltage for the LO Multiplier (See Figure 5). External bypass capacitors of 120 pF, 0.01 μF, and 4.7 μF are recommended (see Figure 211).
20	LOIN	Local Oscillator Input. This pad is dc-coupled and matched to 50 Ω (see Figure 6).
23	RFIN	RF Input. This pad is ac-coupled and matched to 50 Ω (see Figure 7).
26, 30, 34, 38	VGLNA1, VGLNA2, VGLNA3, VGLNA4	Gate Voltage for the Low Noise Amplifier (See Figure 8). External bypass capacitors of 120 pF, 0.01 μF, and 4.7 μF are recommended (see Figure 211).
28, 32, 36, 40	VDLNA1, VDLNA2, VDLNA3, VDLNA4	Power Supply Voltage for the Low Noise Amplifier (See Figure 8). External bypass capacitors of 120 pF, 0.01 μF, and 4.7 μF are recommended (see Figure 211).
Die Bottom	GND	Ground. The die bottom must be connected to RF/dc ground (see Figure 3).

INTERFACE SCHEMATICS



Figure 3. GND Interface

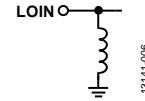

Figure 6. LOIN Interface

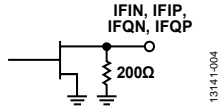

Figure 4. IFIN, IFIP, IFQN, and IFQP Interface

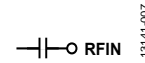

Figure 7. RFIN Interface

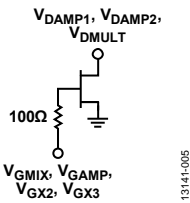

Figure 5. V_{GMIX} , V_{DAMP1} , V_{DAMP2} , V_{DMULT} , V_{GAMP} , V_{GX2} , and V_{GX3} Interface

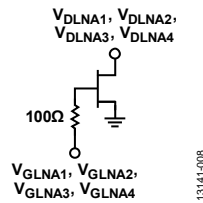

Figure 8. V_{DLNA1} , V_{DLNA2} , V_{DLNA3} , V_{DLNA4} , V_{GLNA1} , V_{GLNA2} , V_{GLNA3} , and V_{GLNA4} Interface

TYPICAL PERFORMANCE CHARACTERISTICS

UPPER SIDEBAND SELECTED, IF = 500 MHz

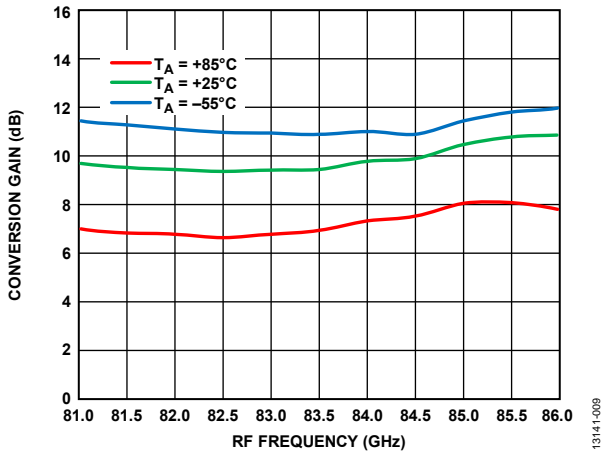

Figure 9. Conversion Gain vs. RF Frequency at Various Temperatures, $R_{FIN} = -20$ dBm, $LO = 2$ dBm, $IF = 500$ MHz, Voltage on the V_{DLNAx} Pins ($V_{DLNA} = 4$ V

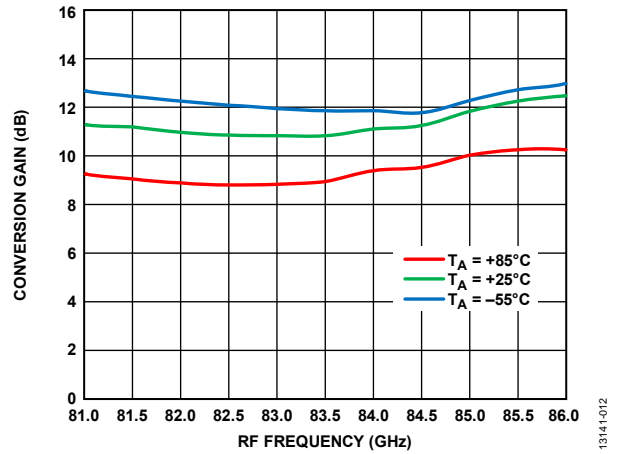

Figure 12. Conversion Gain vs. RF Frequency at Various Temperatures, $R_{FIN} = -20$ dBm, $LO = 2$ dBm, $IF = 500$ MHz, $V_{DLNA} = 3$ V

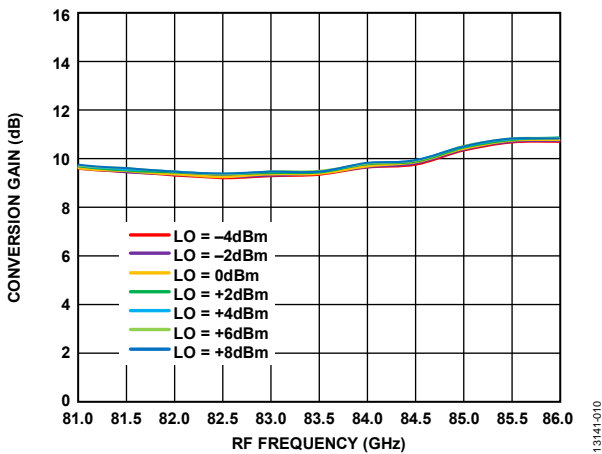

Figure 10. Conversion Gain vs. RF Frequency at Various LO Powers, $R_{FIN} = -20$ dBm, $IF = 500$ MHz, $V_{DLNA} = 4$ V

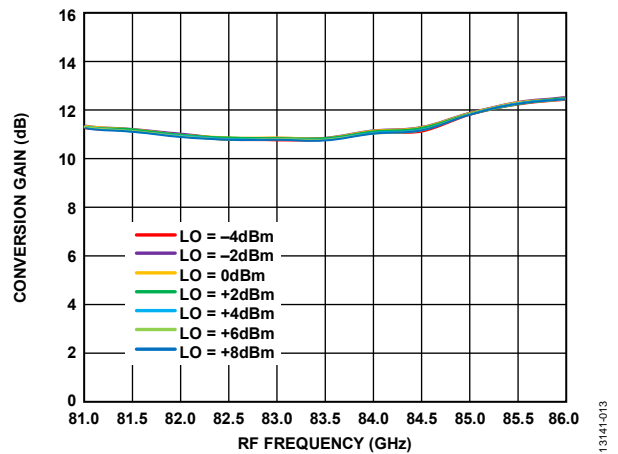

Figure 13. Conversion Gain vs. RF Frequency at Various LO Powers, $R_{FIN} = -20$ dBm, $IF = 500$ MHz, $V_{DLNA} = 3$ V

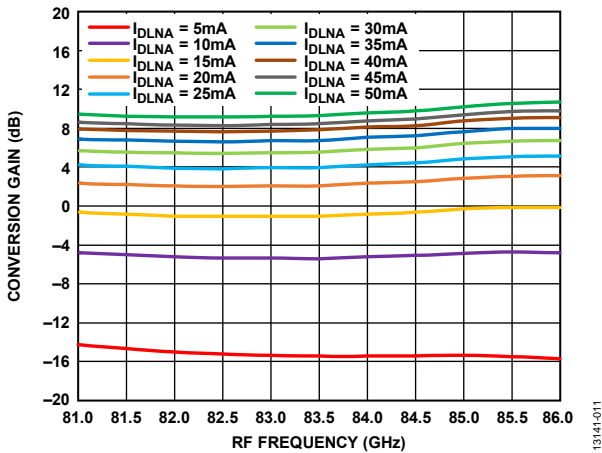

Figure 11. Conversion Gain vs. RF Frequency at Various I_{DLNA} Values, $R_{FIN} = -20$ dBm, $LO = 2$ dBm, $IF = 500$ MHz, $V_{DLNA} = 4$ V

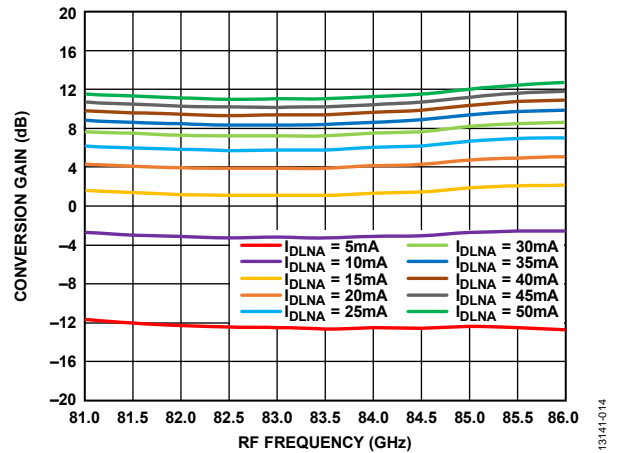

Figure 14. Conversion Gain vs. RF Frequency at Various I_{DLNA} Values, $R_{FIN} = -20$ dBm, $LO = 2$ dBm, $IF = 500$ MHz, $V_{DLNA} = 3$ V

13141-009

13141-012

13141-010

13141-013

13141-011

13141-014

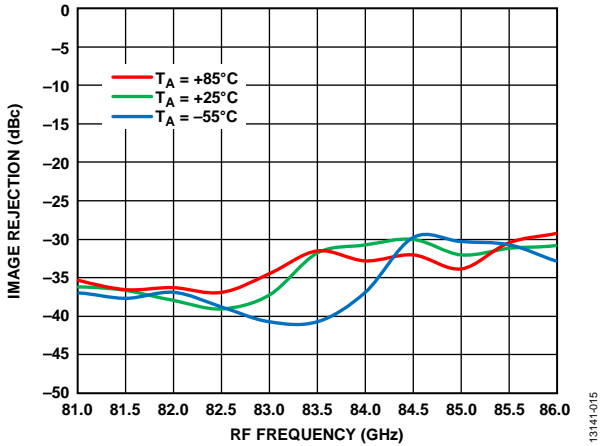

Figure 15. Image Rejection vs. RF Frequency at Various Temperatures, $R_{FIN} = -20$ dBm, $L_O = 2$ dBm, $I_F = 500$ MHz, $V_{DLNA} = 4$ V

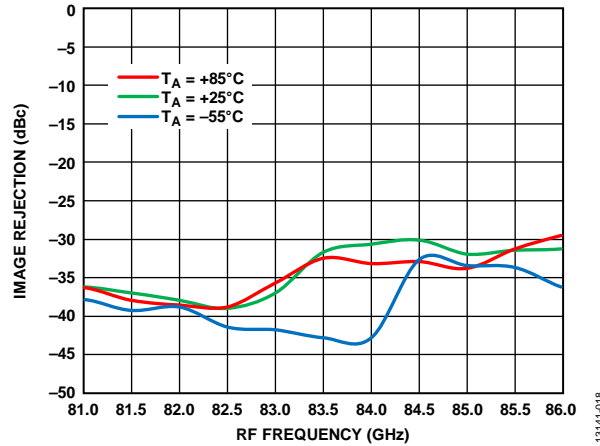

Figure 18. Image Rejection vs. RF Frequency at Various Temperatures, $R_{FIN} = -20$ dBm, $L_O = 2$ dBm, $I_F = 500$ MHz, $V_{DLNA} = 3$ V

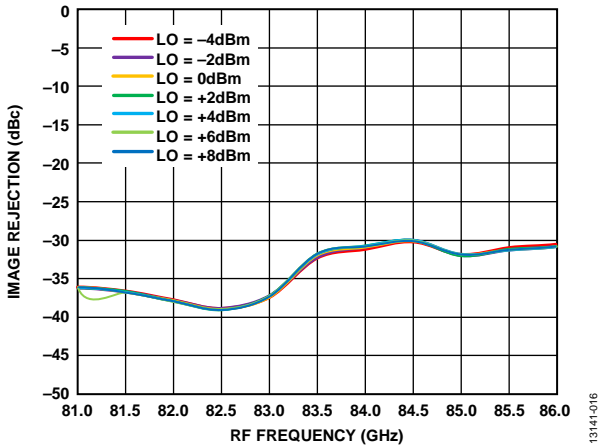

Figure 16. Image Rejection vs. RF Frequency at Various LO Powers, $R_{FIN} = -20$ dBm, $I_F = 500$ MHz, $V_{DLNA} = 4$ V

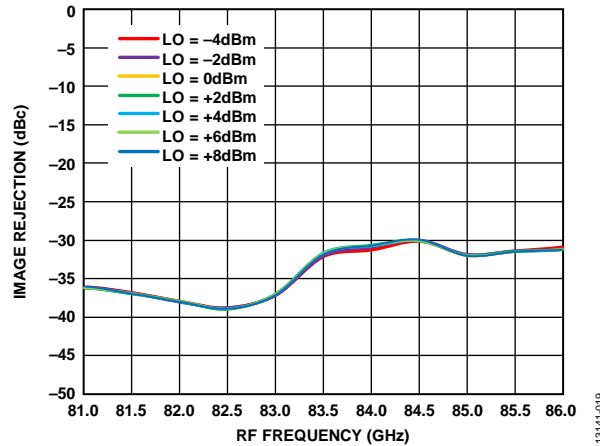

Figure 19. Image Rejection vs. RF Frequency at Various LO Powers, $R_{FIN} = -20$ dBm, $I_F = 500$ MHz, $V_{DLNA} = 3$ V

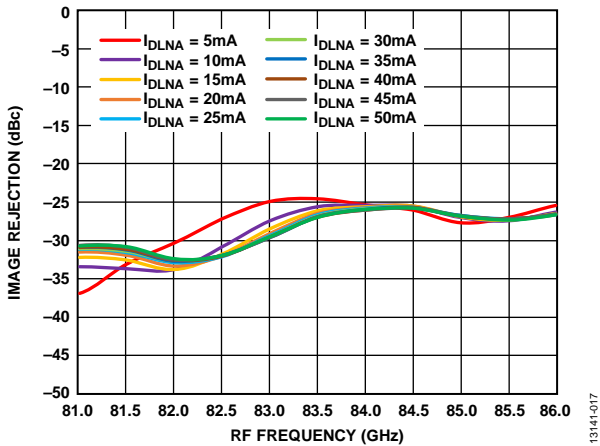

Figure 17. Image Rejection vs. RF Frequency at Various I_{DLNA} Values, $R_{FIN} = -20$ dBm, $L_O = 2$ dBm, $I_F = 500$ MHz, $V_{DLNA} = 4$ V

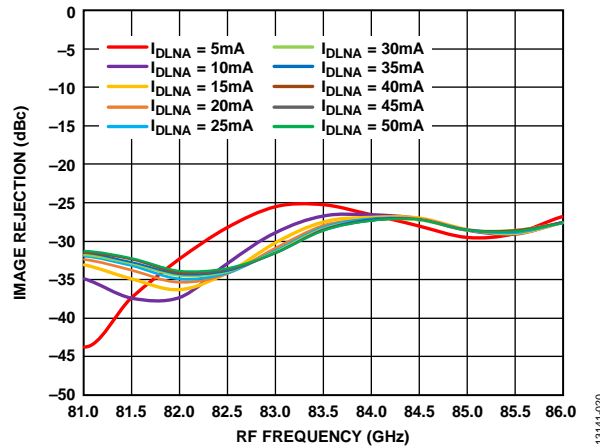

Figure 20. Image Rejection vs. RF Frequency at Various I_{DLNA} Values, $R_{FIN} = -20$ dBm, $L_O = 2$ dBm, $I_F = 500$ MHz, $V_{DLNA} = 3$ V

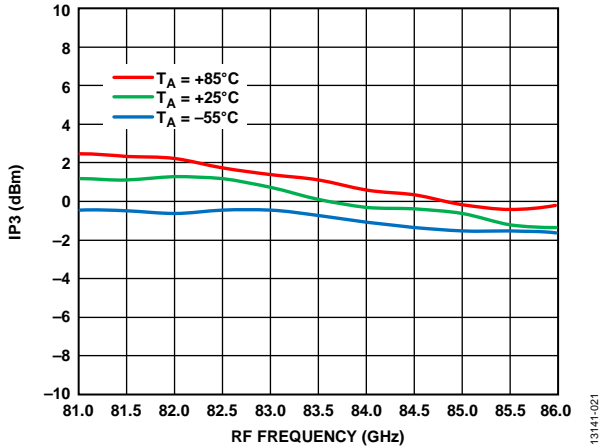

Figure 21. Input IP3 vs. RF Frequency at Various Temperatures, $R_{FIN} = -20$ dBm, LO = 2 dBm, IF = 500 MHz, $V_{DLNA} = 4$ V

13141-021

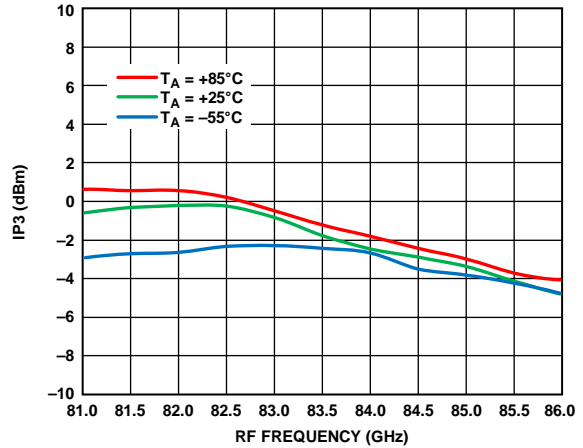

Figure 24. Input IP3 vs. RF Frequency at Various Temperatures, $R_{FIN} = -20$ dBm, LO = 2 dBm, IF = 500 MHz, $V_{DLNA} = 3$ V

13141-024

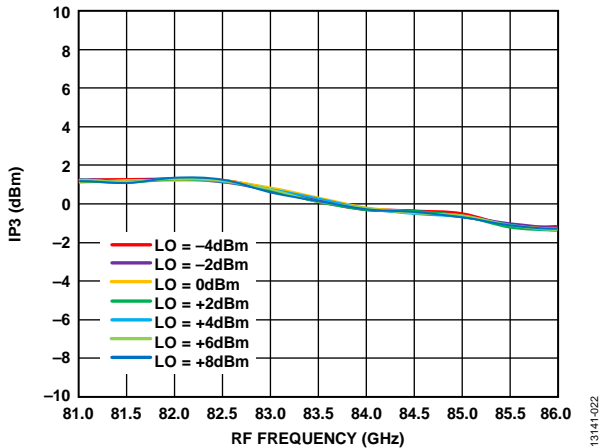

Figure 22. Input IP3 vs. RF Frequency at Various LO Powers, $R_{FIN} = -20$ dBm, IF = 500 MHz, $V_{DLNA} = 4$ V

13141-022

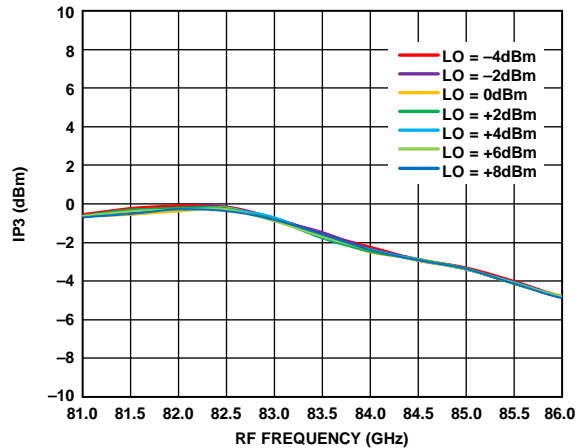

Figure 25. Input IP3 vs. RF Frequency at Various LO Powers, $R_{FIN} = -20$ dBm, IF = 500 MHz, $V_{DLNA} = 3$ V

13141-025

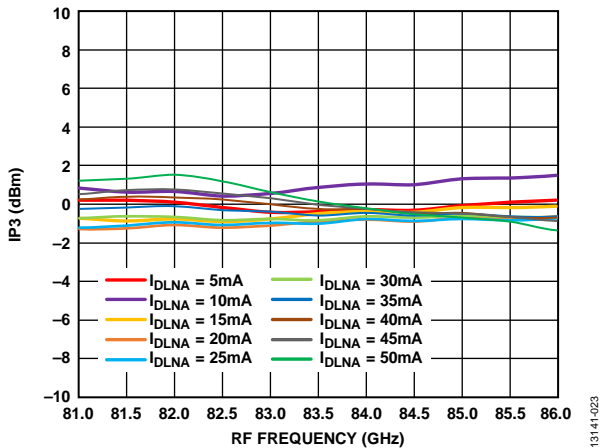

Figure 23. Input IP3 vs. RF Frequency at Various I_{DLNA} Values, $R_{FIN} = -20$ dBm, LO = 2 dBm, IF = 500 MHz, $V_{DLNA} = 4$ V

13141-023

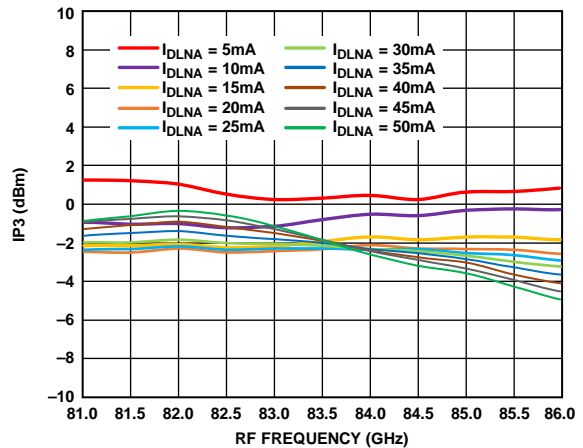

Figure 26. Input IP3 vs. RF Frequency at Various I_{DLNA} Values, $R_{FIN} = -20$ dBm, LO = 2 dBm, IF = 500 MHz, $V_{DLNA} = 3$ V

13141-026

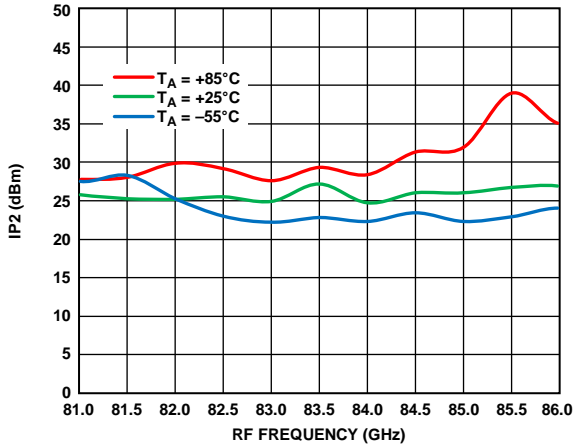

Figure 27. Input IP2 vs. RF Frequency at Various Temperatures, $R_{FIN} = -20$ dBm, LO = 2 dBm, IF = 500 MHz, $V_{DLNA} = 4$ V

13141-027

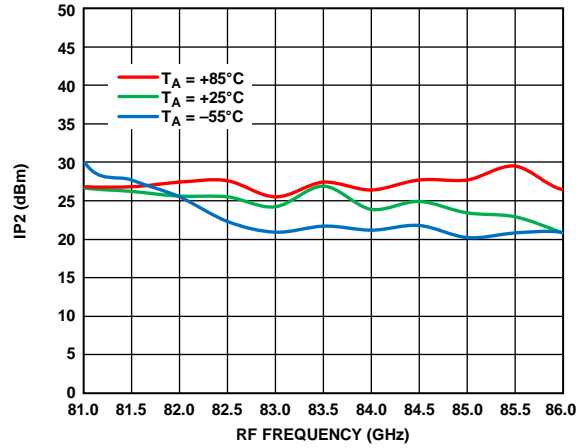

Figure 30. Input IP2 vs. RF Frequency at Various Temperatures, $R_{FIN} = -20$ dBm, LO = 2 dBm, IF = 500 MHz, $V_{DLNA} = 3$ V

13141-030

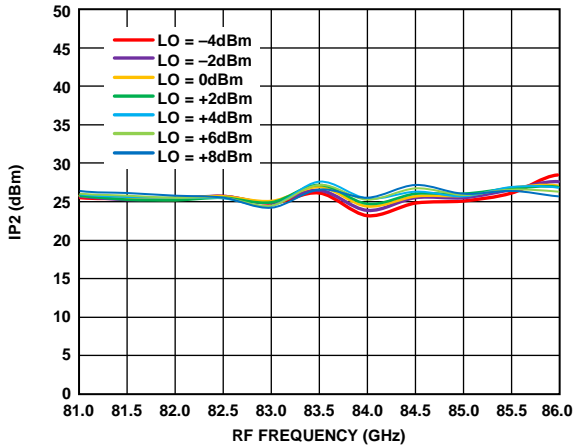

Figure 28. Input IP2 vs. RF Frequency at Various LO Powers, $R_{FIN} = -20$ dBm, IF = 500 MHz, $V_{DLNA} = 4$ V

13141-028

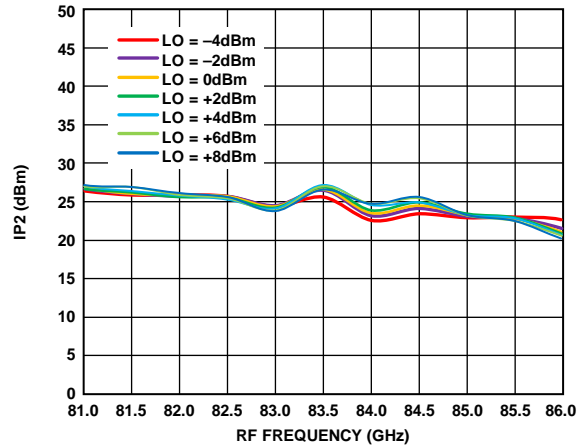

Figure 31. Input IP2 vs. RF Frequency at Various LO Powers, $R_{FIN} = -20$ dBm, IF = 500 MHz, $V_{DLNA} = 3$ V

13141-031

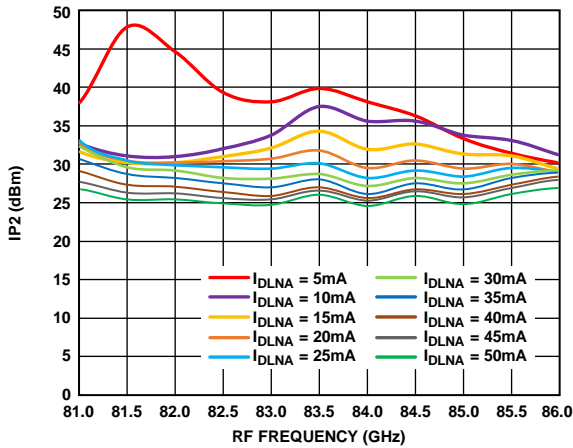

Figure 29. Input IP2 vs. RF Frequency at Various I_{DLNA} Values, $R_{FIN} = -20$ dBm, LO = 2 dBm, IF = 500 MHz, $V_{DLNA} = 4$ V

13141-029

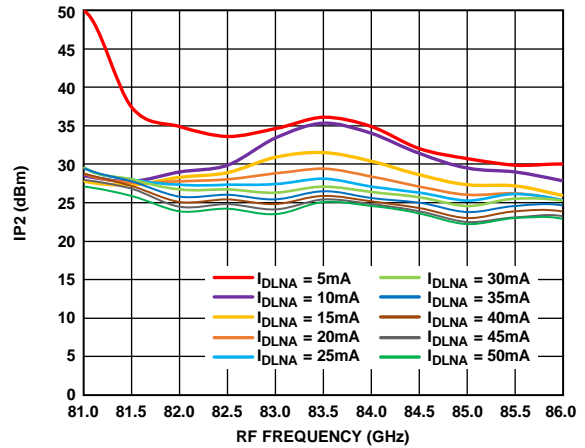

Figure 32. Input IP2 vs. RF Frequency at Various I_{DLNA} Values, $R_{FIN} = -20$ dBm, LO = 2 dBm, IF = 500 MHz, $V_{DLNA} = 3$ V

13141-032

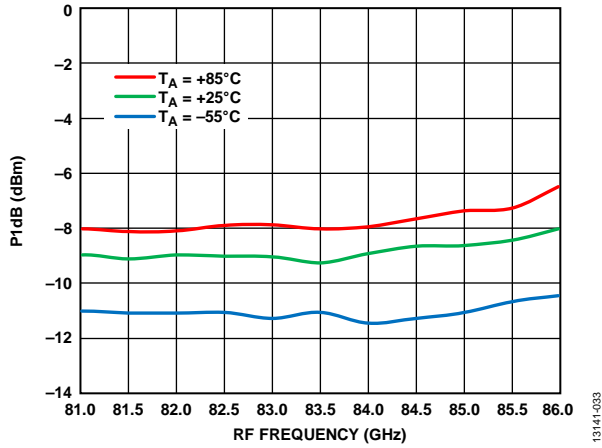

Figure 33. Input P1dB vs. RF Frequency at Various Temperatures, LO = 2 dBm, IF = 500 MHz, V_{DLNA} = 4 V

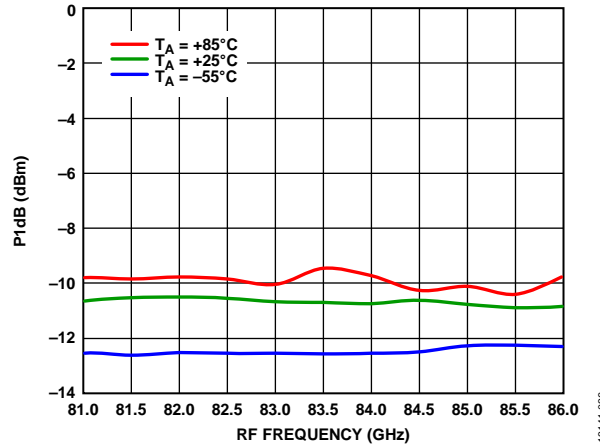

Figure 36. Input P1dB vs. RF Frequency at Various Temperatures, LO = 2 dBm, IF = 500 MHz, V_{DLNA} = 3 V

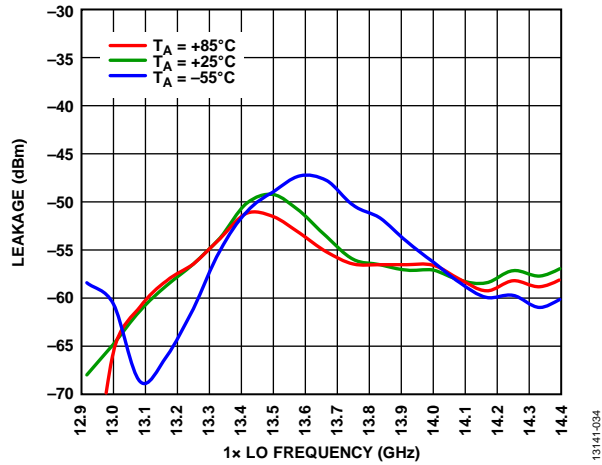

Figure 34. 1x LO Leakage at IFOUT vs. 1x LO Frequency at Various Temperatures, LO = 2 dBm, V_{DLNA} = 3 V

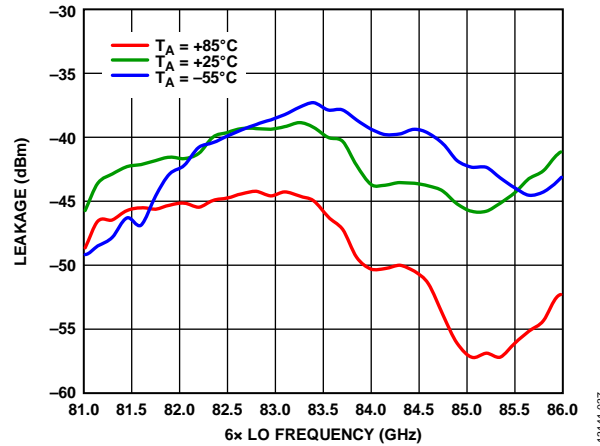

Figure 37. 6x LO Leakage at RFIN vs. 6x LO Frequency at Various Temperatures, LO = 2 dBm, V_{DLNA} = 3 V

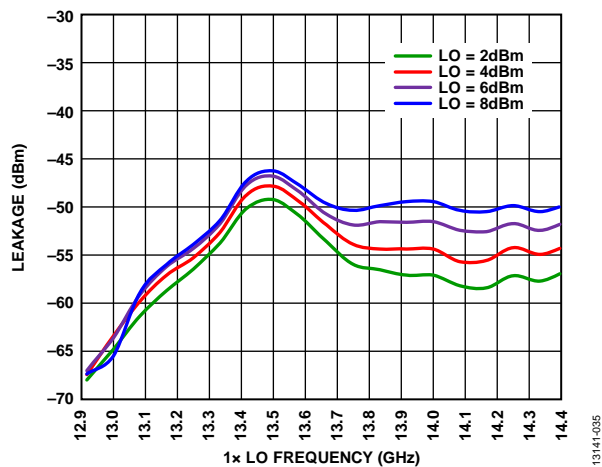

Figure 35. 1x LO Leakage at IFOUT vs. 1x LO Frequency at Various LO Powers, V_{DLNA} = 3 V

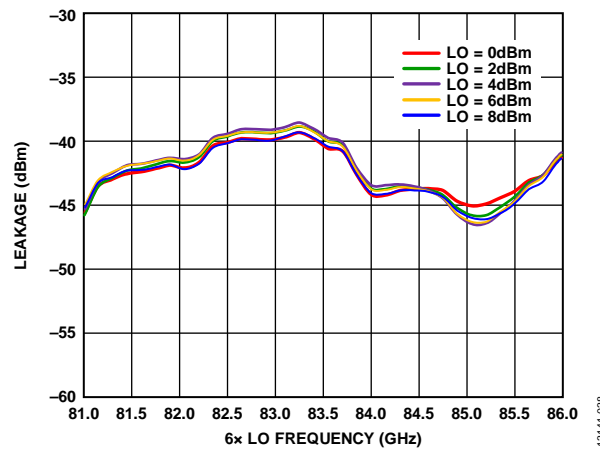

Figure 38. 6x LO Leakage at RFIN vs. 6x LO Frequency at Various LO Powers, V_{DLNA} = 3 V

13141-033

13141-036

13141-034

13141-037

13141-035

13141-038

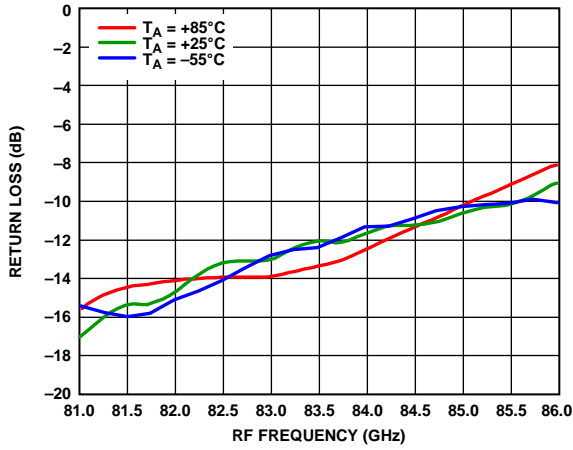

13141-039

Figure 39. RF Return Loss vs. RF Frequency at Various Temperatures, LO = 2 dBm, LO = 12 GHz, $V_{DLNA} = 4 V$

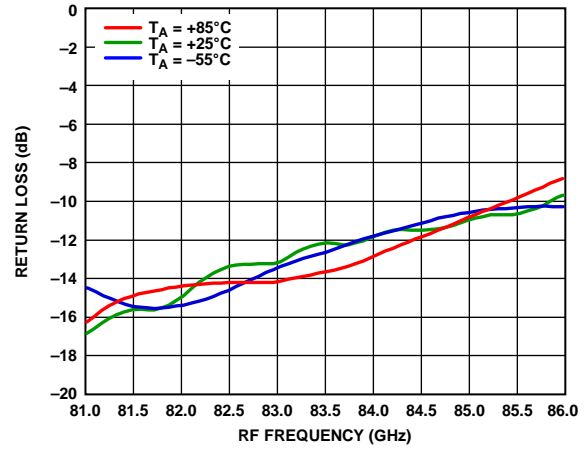

13141-042

Figure 42. RF Return Loss vs. RF Frequency at Various Temperatures, LO = 2 dBm, LO = 12 GHz, $V_{DLNA} = 3 V$

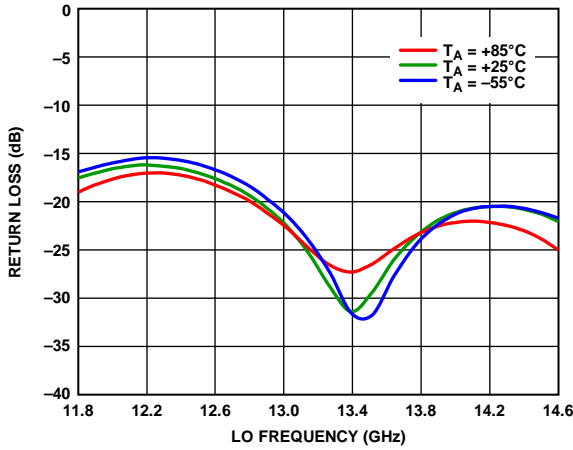

13141-040

Figure 40. LO Return Loss vs. LO Frequency at Various Temperatures, LO = 2 dBm, $V_{DLNA} = 3 V$

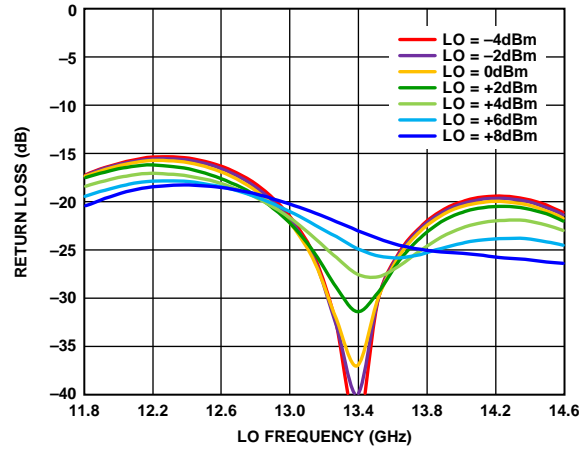

13141-043

Figure 43. LO Return Loss vs. LO Frequency at Various LO Powers, $V_{DLNA} = 3 V$

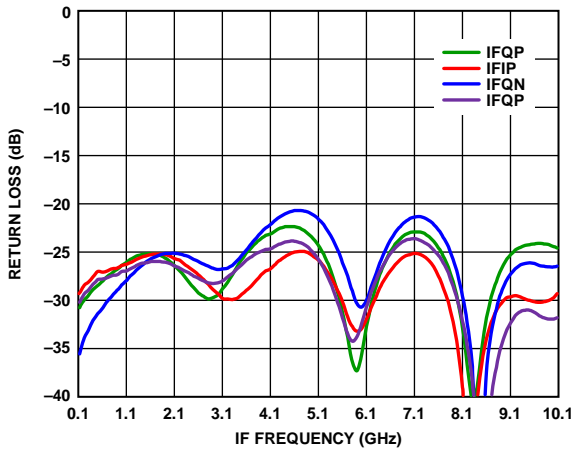

13141-041

Figure 41. IF Return Loss vs. IF Frequency, LO = 2 dBm at 12 GHz, $V_{DLNA} = 3 V$

UPPER SIDEBAND SELECTED, IF = 1000 MHz

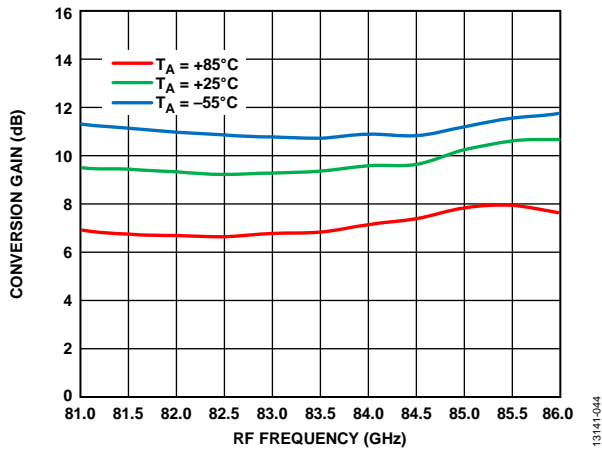

Figure 44. Conversion Gain vs. RF Frequency at Various Temperatures, $R_{FIN} = -20$ dBm, $L_O = 2$ dBm, $I_F = 1000$ MHz, $V_{DLNA} = 4$ V

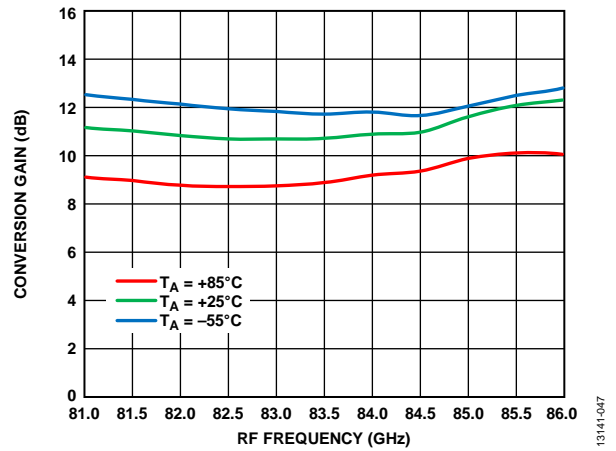

Figure 47. Conversion Gain vs. RF Frequency at Various Temperatures, $R_{FIN} = -20$ dBm, $L_O = 2$ dBm, $I_F = 1000$ MHz, $V_{DLNA} = 3$ V

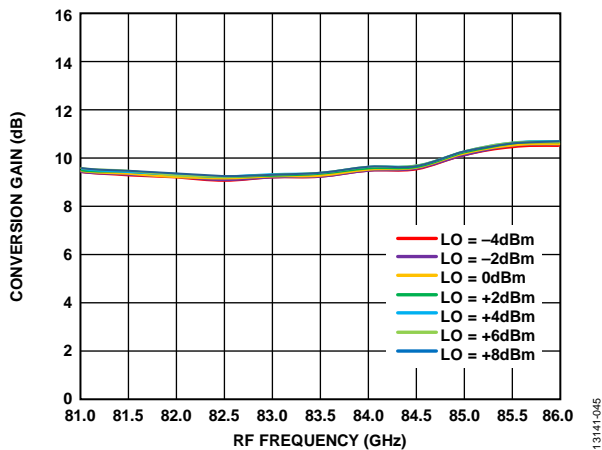

Figure 45. Conversion Gain vs. RF Frequency at Various LO Powers, $R_{FIN} = -20$ dBm, $I_F = 1000$ MHz, $V_{DLNA} = 4$ V

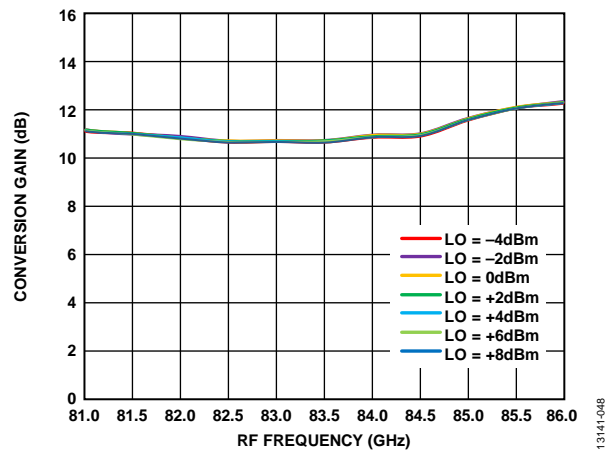

Figure 48. Conversion Gain vs. RF Frequency at Various LO Powers, $R_{FIN} = -20$ dBm, $I_F = 1000$ MHz, $V_{DLNA} = 3$ V

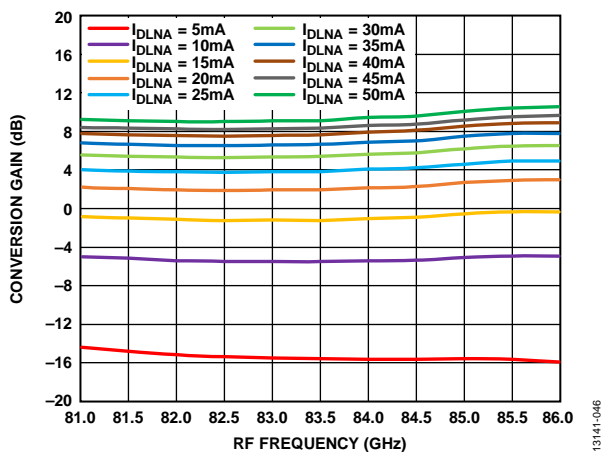

Figure 46. Conversion Gain vs. RF Frequency at Various I_{DLNA} Values, $R_{FIN} = -20$ dBm, $L_O = 2$ dBm, $I_F = 1000$ MHz, $V_{DLNA} = 4$ V

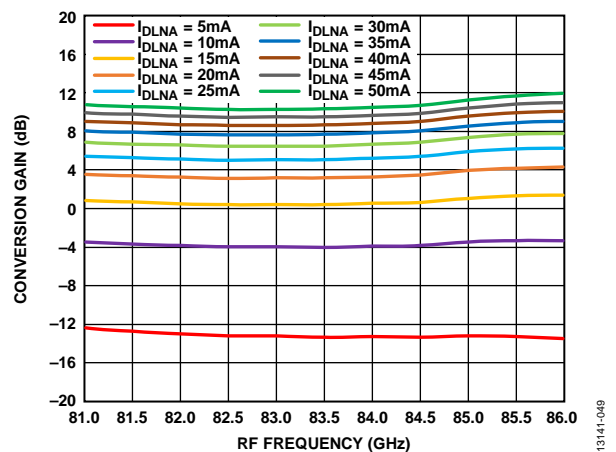

Figure 49. Conversion Gain vs. RF Frequency at Various I_{DLNA} Values, $R_{FIN} = -20$ dBm, $L_O = 2$ dBm, $I_F = 1000$ MHz, $V_{DLNA} = 3$ V

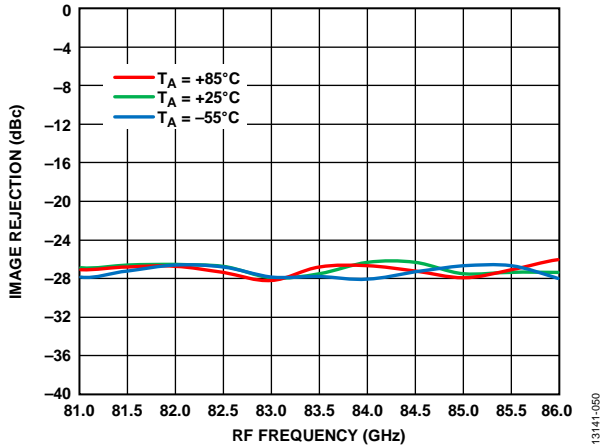

Figure 50. Image Rejection vs. RF Frequency at Various Temperatures, $R_{FIN} = -20$ dBm, LO = 2 dBm, IF = 1000 MHz, $V_{DLNA} = 4$ V

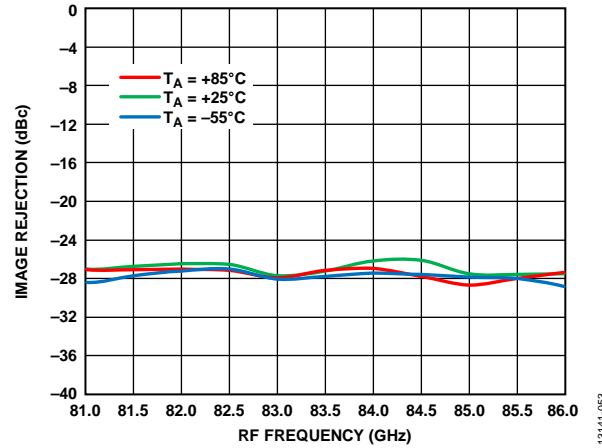

Figure 53. Image Rejection vs. RF Frequency at Various Temperatures, $R_{FIN} = -20$ dBm, LO = 2 dBm, IF = 1000 MHz, $V_{DLNA} = 3$ V

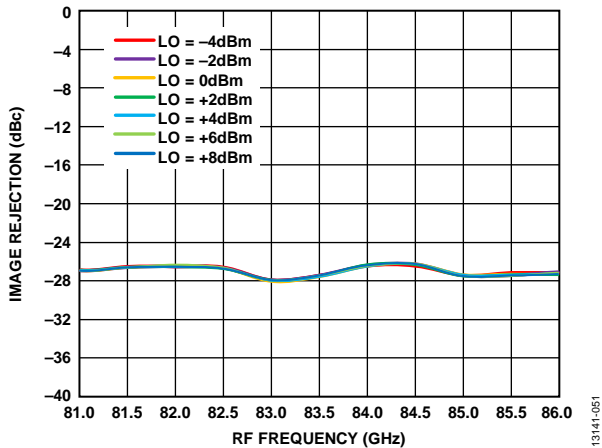

Figure 51. Image Rejection vs. RF Frequency at Various LO Powers, $R_{FIN} = -20$ dBm, IF = 1000 MHz, $V_{DLNA} = 4$ V

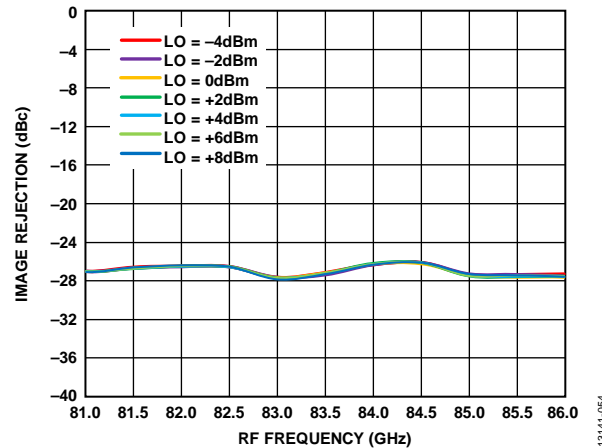

Figure 54. Image Rejection vs. RF Frequency at Various LO Powers, $R_{FIN} = -20$ dBm, IF = 1000 MHz, $V_{DLNA} = 3$ V

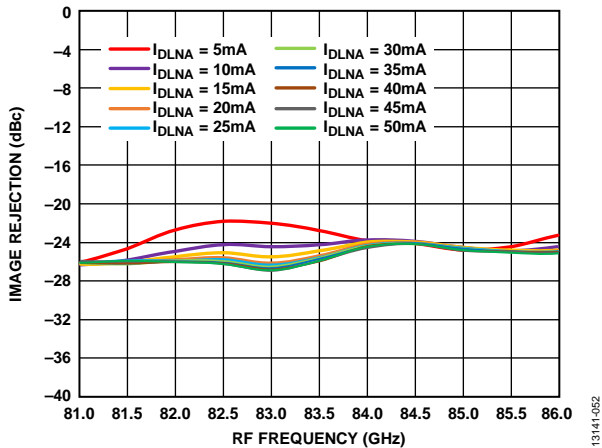

Figure 52. Image Rejection vs. RF Frequency at Various I_{DLNA} Values, $R_{FIN} = -20$ dBm, LO = 2 dBm, IF = 1000 MHz, $V_{DLNA} = 4$ V

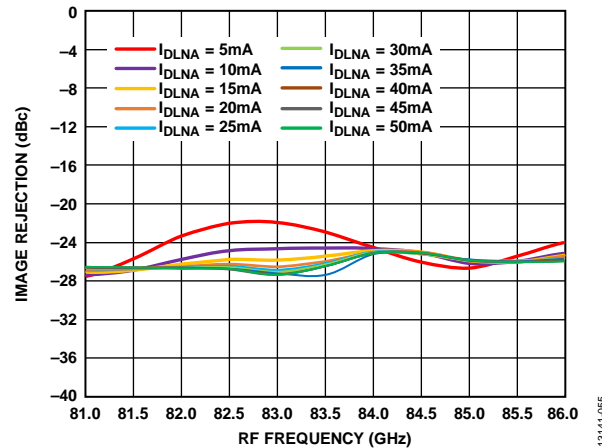

Figure 55. Image Rejection vs. RF Frequency at Various I_{DLNA} Values, $R_{FIN} = -20$ dBm, LO = 2 dBm, IF = 1000 MHz, $V_{DLNA} = 3$ V

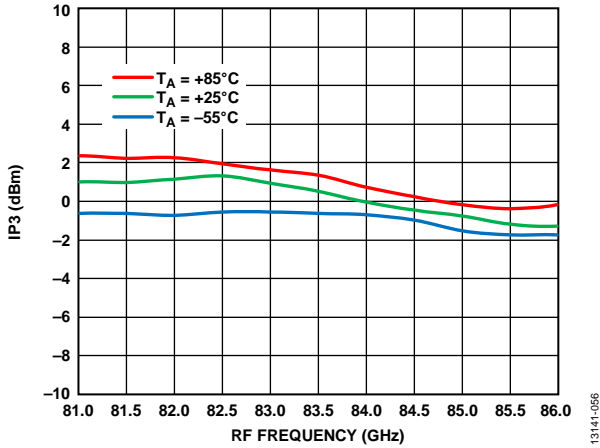

Figure 56. Input IP3 vs. RF Frequency at Various Temperatures, $R_{FIN} = -20$ dBm, $LO = 2$ dBm, $IF = 1000$ MHz, $V_{DLNA} = 4$ V

13141-0566

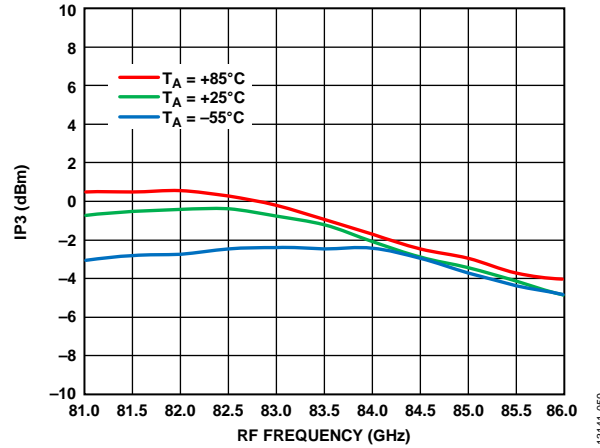

Figure 59. Input IP3 vs. RF Frequency at Various Temperatures, $R_{FIN} = -20$ dBm, $LO = 2$ dBm, $IF = 1000$ MHz, $V_{DLNA} = 3$ V

13141-0569

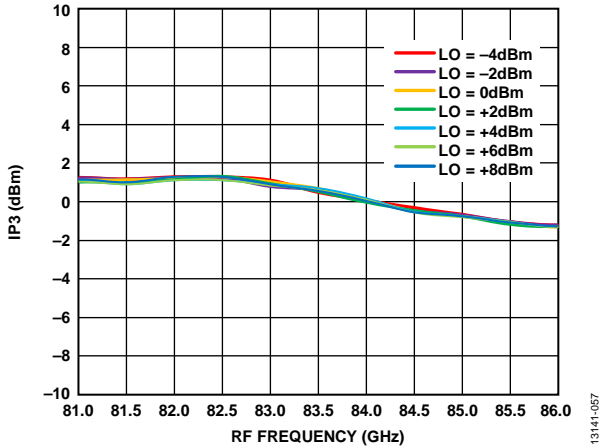

Figure 57. Input IP3 vs. RF Frequency at Various LO Powers, $R_{FIN} = -20$ dBm, $IF = 1000$ MHz, $V_{DLNA} = 4$ V

13141-057

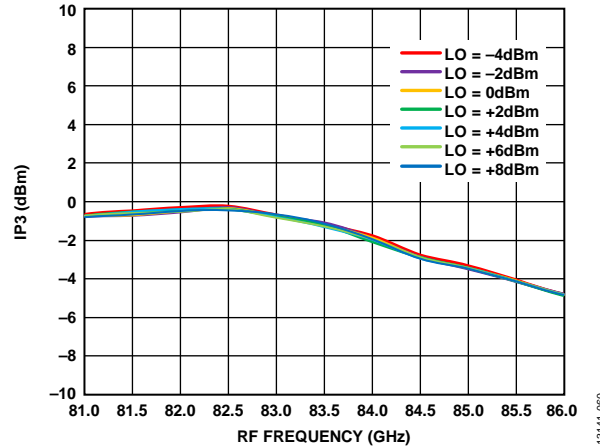

Figure 60. Input IP3 vs. RF Frequency at Various LO Powers, $R_{FIN} = -20$ dBm, $IF = 1000$ MHz, $V_{DLNA} = 3$ V

13141-060

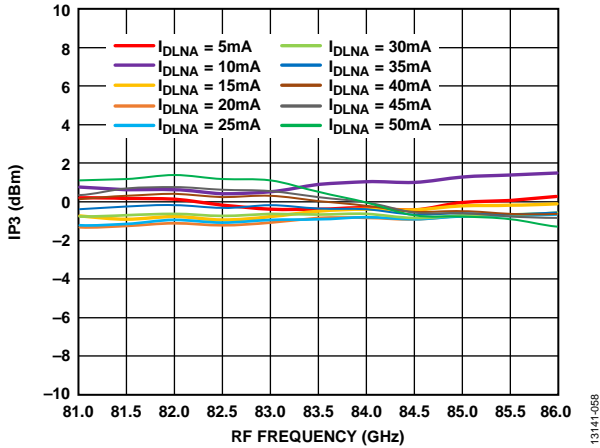

Figure 58. Input IP3 vs. RF Frequency at Various I_{DLNA} Values, $R_{FIN} = -20$ dBm, $LO = 2$ dBm, $IF = 1000$ MHz, $V_{DLNA} = 4$ V

13141-0588

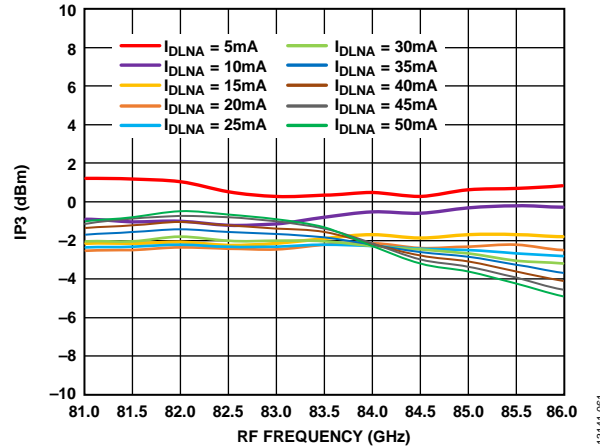

Figure 61. Input IP3 vs. RF Frequency at Various I_{DLNA} Values, $R_{FIN} = -20$ dBm, $LO = 2$ dBm, $IF = 1000$ MHz, $V_{DLNA} = 3$ V

13141-061

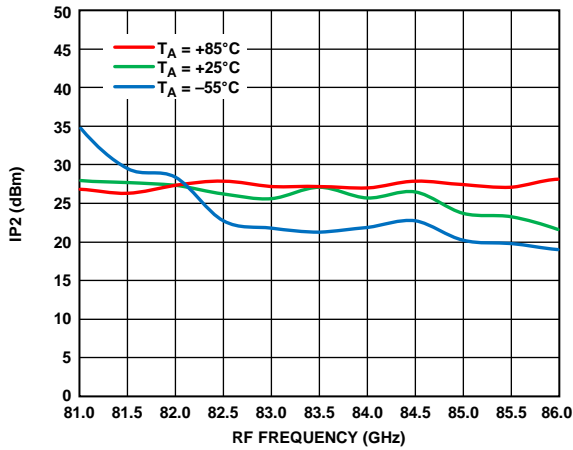

Figure 62. Input IP2 vs. RF Frequency at Various Temperatures, $R_{FIN} = -20$ dBm, LO = 2 dBm, IF = 1000 MHz, $V_{DLNA} = 4$ V

13141-062

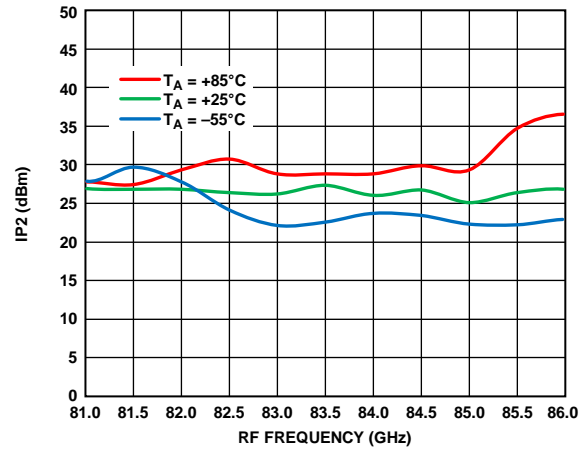

Figure 65. Input IP2 vs. RF Frequency at Various Temperatures, $R_{FIN} = -20$ dBm, LO = 2 dBm, IF = 1000 MHz, $V_{DLNA} = 3$ V

13141-065

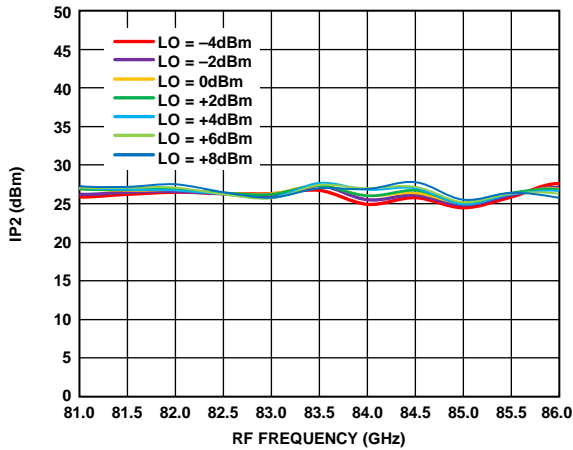

Figure 63. Input IP2 vs. RF Frequency at Various LO Powers, $R_{FIN} = -20$ dBm, IF = 1000 MHz, $V_{DLNA} = 4$ V

13141-063

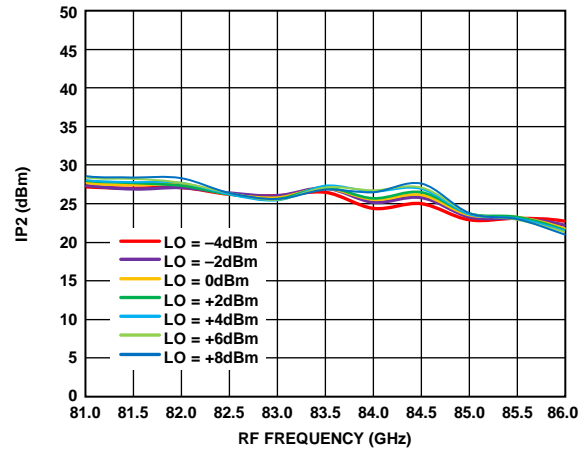

Figure 66. Input IP2 vs. RF Frequency at Various LO Powers, $R_{FIN} = -20$ dBm, IF = 1000 MHz, $V_{DLNA} = 3$ V

13141-066

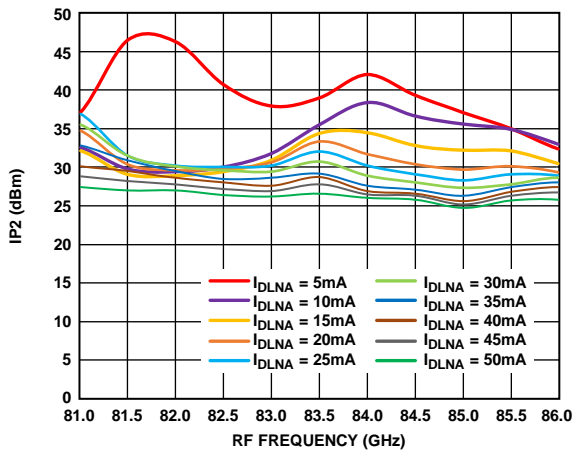

Figure 64. Input IP2 vs. RF Frequency at Various I_{DLNA} Values, $R_{FIN} = -20$ dBm, LO = 2 dBm, IF = 1000 MHz, $V_{DLNA} = 4$ V

13141-064

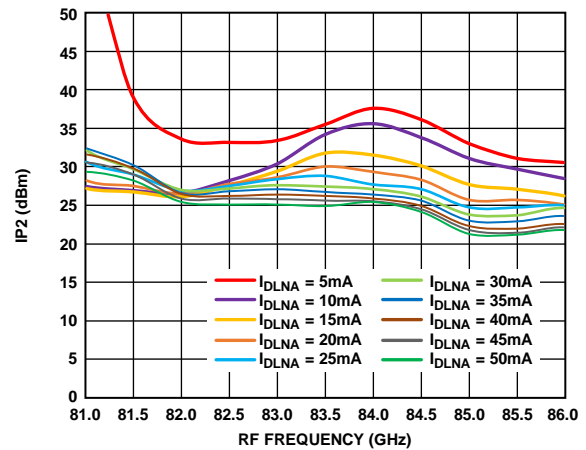

Figure 67. Input IP2 vs. RF Frequency at Various I_{DLNA} Values, $R_{FIN} = -20$ dBm, LO = 2 dBm, IF = 1000 MHz, $V_{DLNA} = 3$ V

13141-067

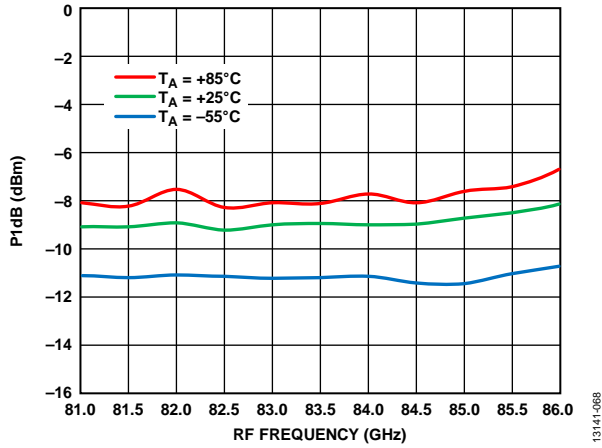

Figure 68. Input P1dB vs. RF Frequency at Various Temperatures, LO = 2 dBm, IF = 1000 MHz, V_{DLNA} = 4 V

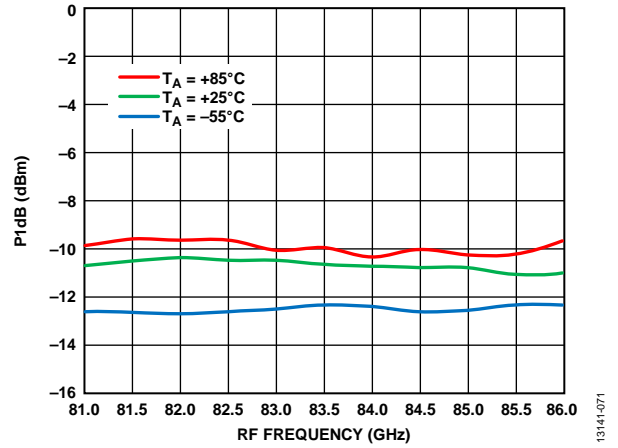

Figure 69. Input P1dB vs. RF Frequency at Various Temperatures, LO = 2 dBm, IF = 1000 MHz, V_{DLNA} = 3 V

UPPER SIDEBAND SELECTED, IF = 2000 MHz

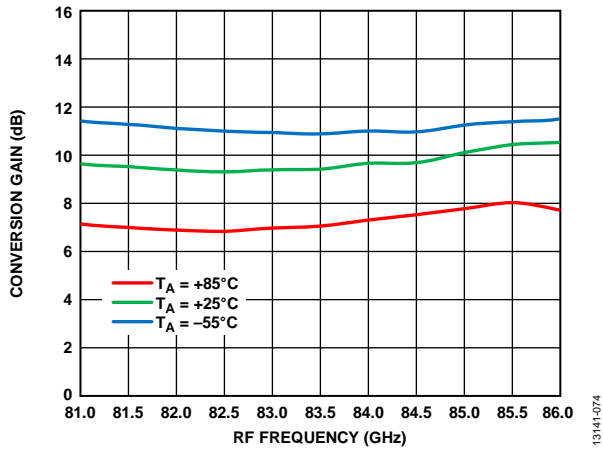

Figure 70. Conversion Gain vs. RF Frequency at Various Temperatures, RFIN = -20 dBm, LO = 2 dBm, IF = 2000 MHz, VDLNA = 4 V

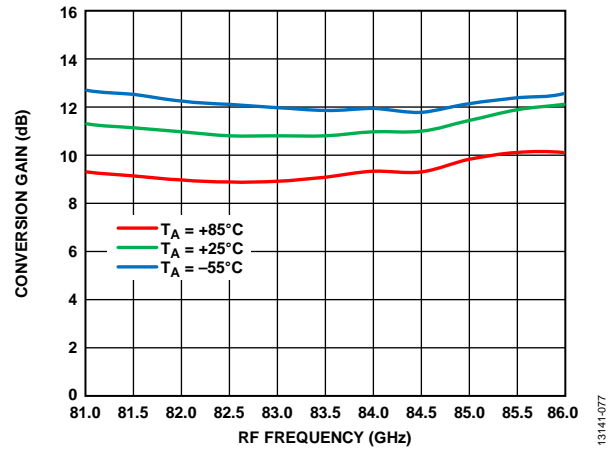

Figure 73. Conversion Gain vs. RF Frequency at Various Temperatures, RFIN = -20 dBm, LO = 2 dBm, IF = 2000 MHz, VDLNA = 3 V

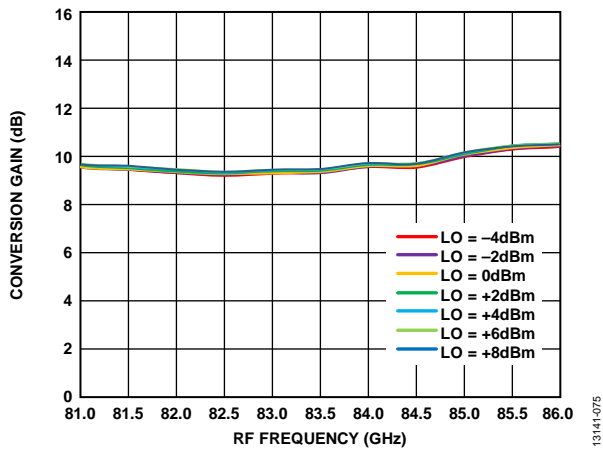

Figure 71. Conversion Gain vs. RF Frequency at Various LO Powers, RFIN = -20 dBm, IF = 2000 MHz, VDLNA = 4 V

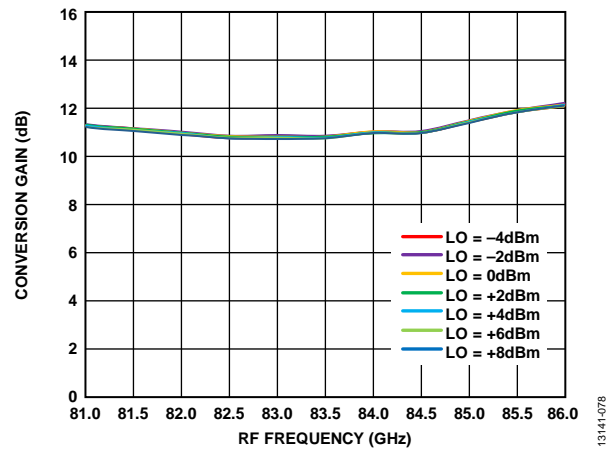

Figure 74. Conversion Gain vs. RF Frequency at Various LO Powers, RFIN = -20 dBm, IF = 2000 MHz, VDLNA = 3 V

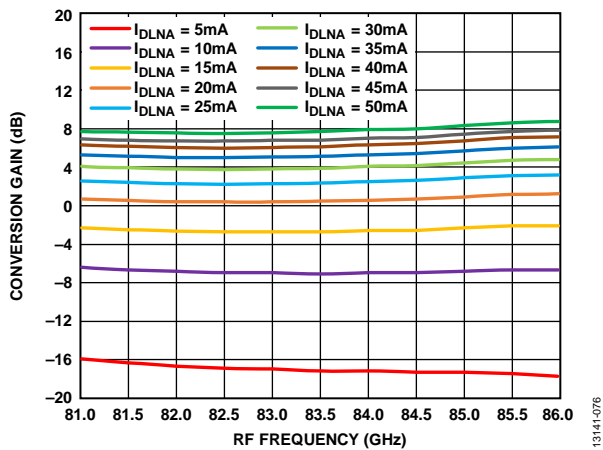

Figure 72. Conversion Gain vs. RF Frequency at Various IDLNA Values, RFIN = -20 dBm, LO = 2 dBm, IF = 2000 MHz, VDLNA = 4 V

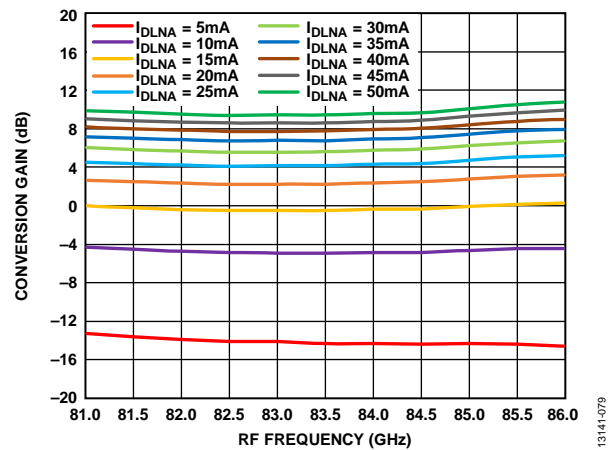

Figure 75. Conversion Gain vs. RF Frequency at Various IDLNA Values, RFIN = -20 dBm, LO = 2 dBm, IF = 2000 MHz, VDLNA = 3 V

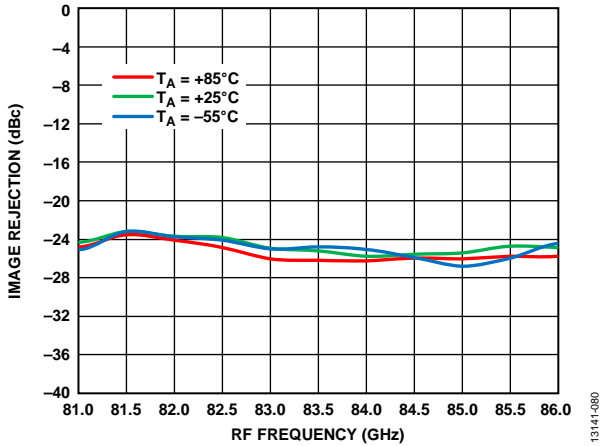

Figure 76. Image Rejection vs. RF Frequency at Various Temperatures, $R_{FIN} = -20$ dBm, $L_O = 2$ dBm, $I_F = 2000$ MHz, $V_{DLNA} = 4$ V

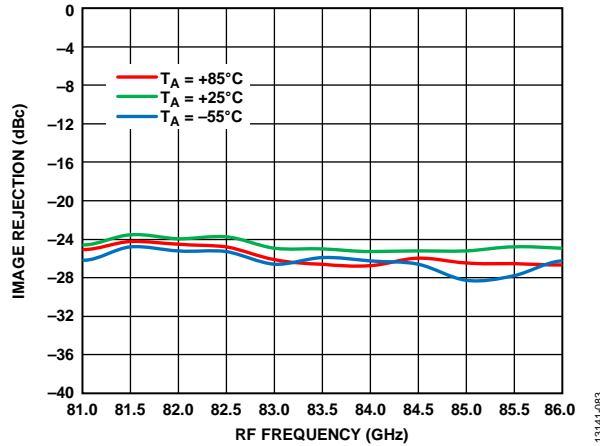

Figure 79. Image Rejection vs. RF Frequency at Various Temperatures, $R_{FIN} = -20$ dBm, $L_O = 2$ dBm, $I_F = 2000$ MHz, $V_{DLNA} = 3$ V

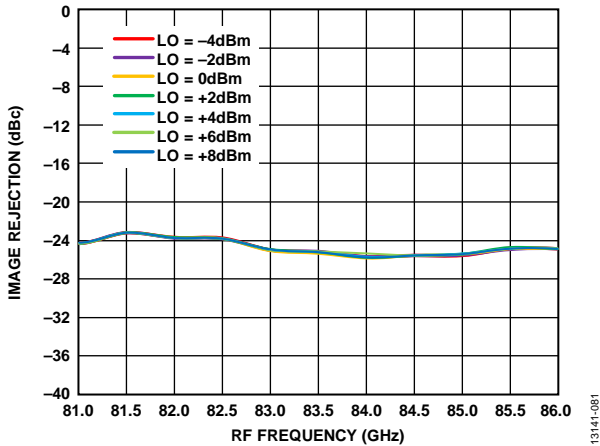

Figure 77. Image Rejection vs. RF Frequency at Various LO Powers, $R_{FIN} = -20$ dBm, $I_F = 2000$ MHz, $V_{DLNA} = 4$ V

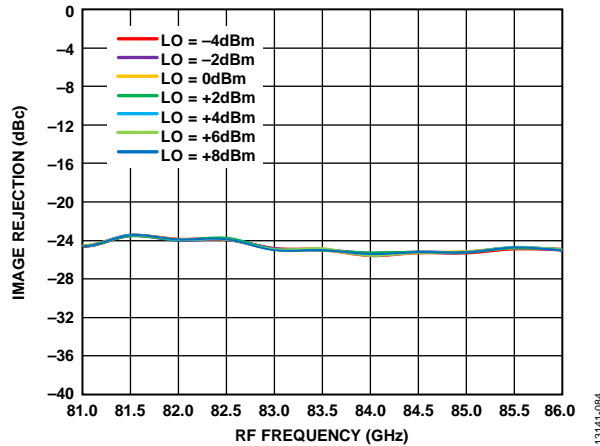

Figure 80. Image Rejection vs. RF Frequency at Various LO Powers, $R_{FIN} = -20$ dBm, $I_F = 2000$ MHz, $V_{DLNA} = 3$ V

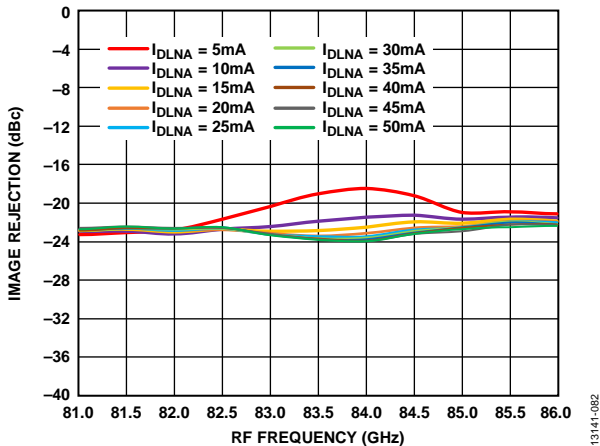

Figure 78. Image Rejection vs. RF Frequency at Various I_{DLNA} Values, $R_{FIN} = -20$ dBm, $L_O = 2$ dBm, $I_F = 2000$ MHz, $V_{DLNA} = 4$ V

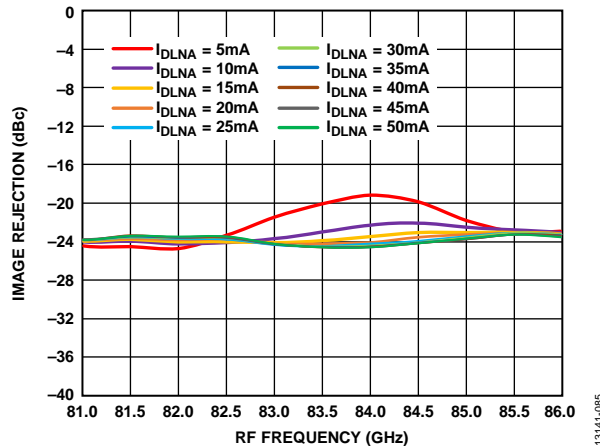

Figure 81. Image Rejection vs. RF Frequency at Various I_{DLNA} Values, $R_{FIN} = -20$ dBm, $L_O = 2$ dBm, $I_F = 2000$ MHz, $V_{DLNA} = 3$ V

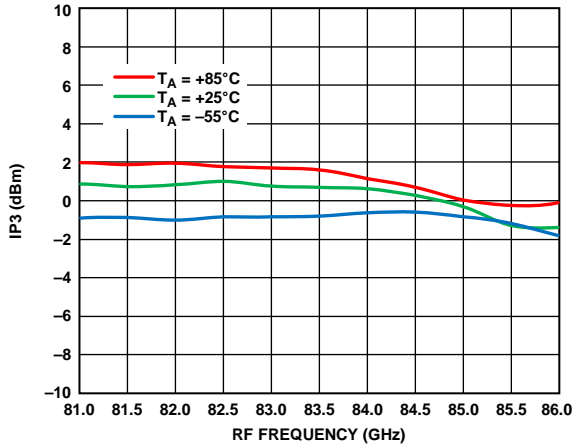

Figure 82. Input IP3 vs. RF Frequency at Various Temperatures, $R_{FIN} = -20$ dBm, LO = 2 dBm, IF = 2000 MHz, $V_{DLNA} = 4$ V

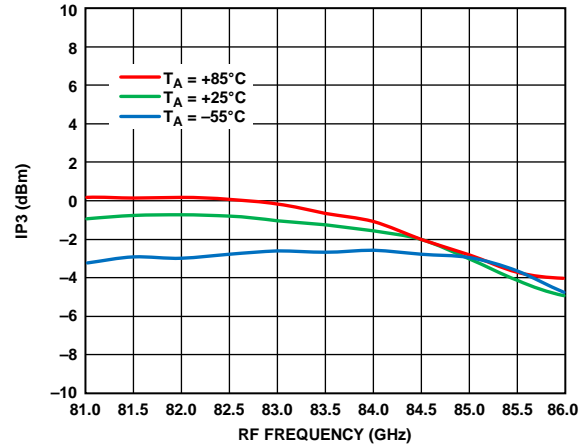

Figure 85. Input IP3 vs. RF Frequency at Various Temperatures, $R_{FIN} = -20$ dBm, LO = 2 dBm, IF = 2000 MHz, $V_{DLNA} = 3$ V

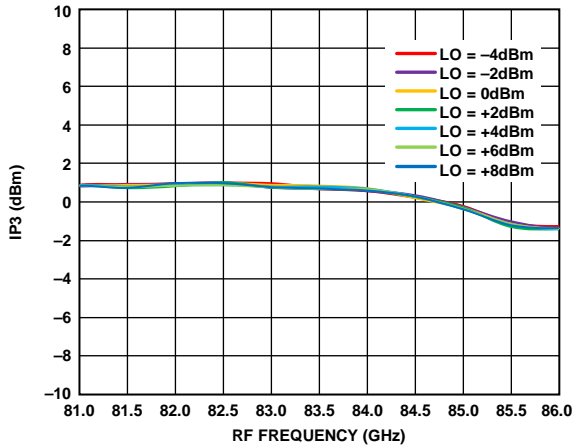

Figure 83. Input IP3 vs. RF Frequency at Various LO Powers, $R_{FIN} = -20$ dBm, IF = 2000 MHz, $V_{DLNA} = 4$ V

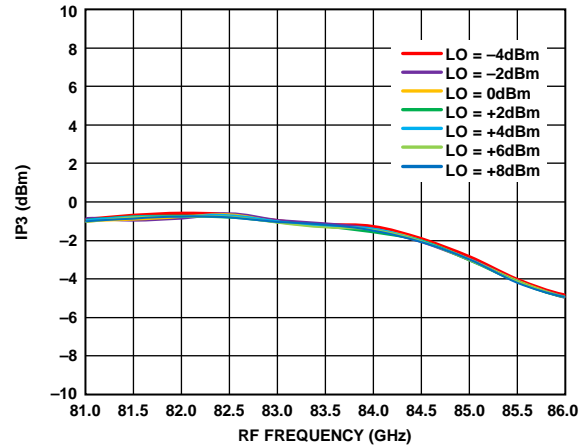

Figure 86. Input IP3 vs. RF Frequency at Various LO Powers, $R_{FIN} = -20$ dBm, IF = 2000 MHz, $V_{DLNA} = 3$ V

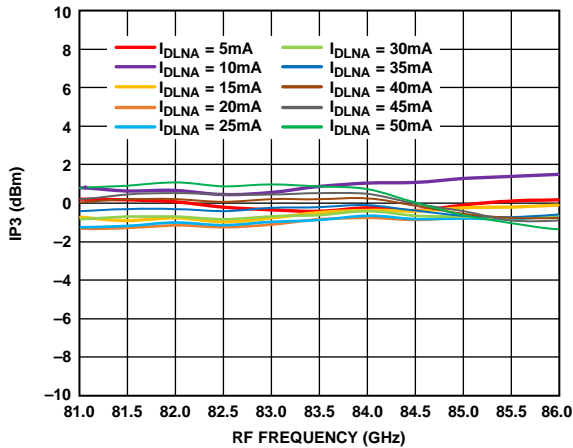

Figure 84. Input IP3 vs. RF Frequency at Various I_{DLNA} Values, $R_{FIN} = -20$ dBm, LO = 2 dBm, IF = 2000 MHz, $V_{DLNA} = 4$ V

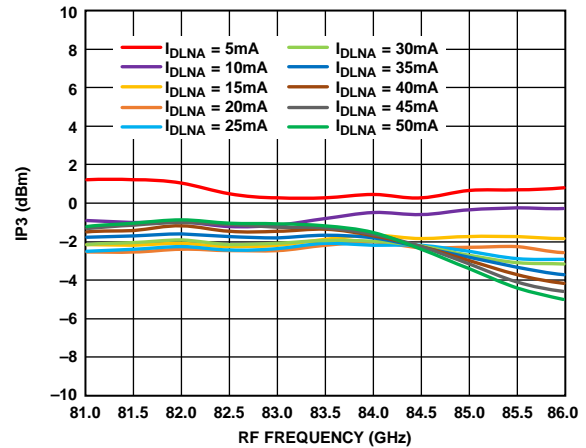

Figure 87. Input IP3 vs. RF Frequency at Various I_{DLNA} Values, $R_{FIN} = -20$ dBm, LO = 2 dBm, IF = 2000 MHz, $V_{DLNA} = 3$ V

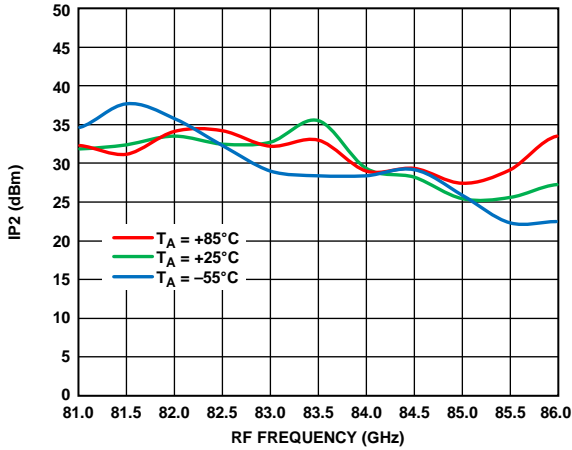

Figure 88. Input IP2 vs. RF Frequency at Various Temperatures, $R_{FIN} = -20$ dBm, $LO = 2$ dBm, $IF = 2000$ MHz, $V_{DLNA} = 4$ V

13141-082

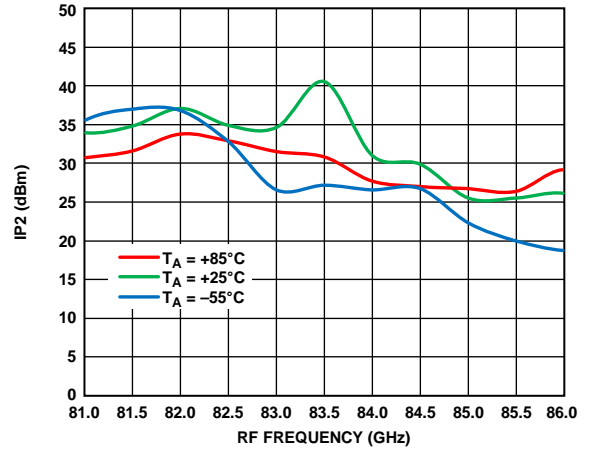

Figure 91. Input IP2 vs. RF Frequency at Various Temperatures, $R_{FIN} = -20$ dBm, $LO = 2$ dBm, $IF = 2000$ MHz, $V_{DLNA} = 3$ V

13141-085

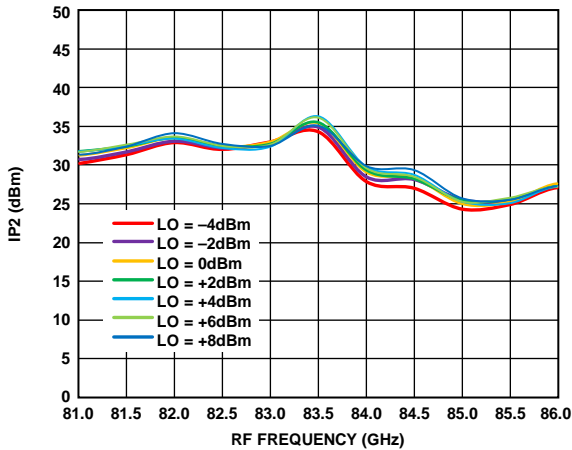

Figure 89. Input IP2 vs. RF Frequency at Various LO Powers, $R_{FIN} = -20$ dBm, $IF = 2000$ MHz, $V_{DLNA} = 4$ V

13141-083

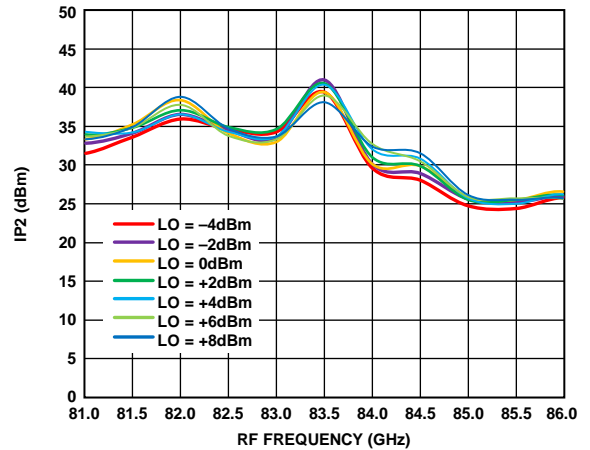

Figure 92. Input IP2 vs. RF Frequency at Various LO Powers, $R_{FIN} = -20$ dBm, $IF = 2000$ MHz, $V_{DLNA} = 3$ V

13141-086

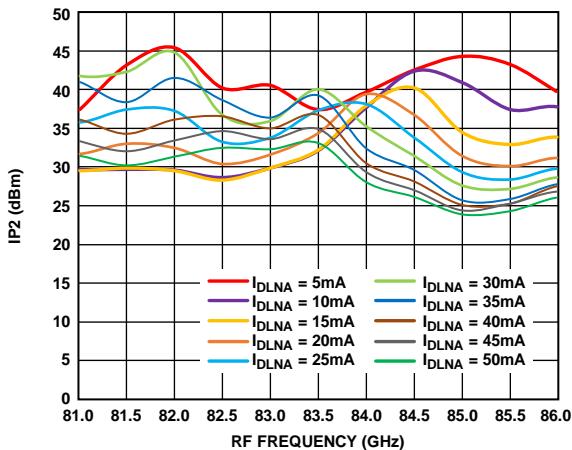

Figure 90. Input IP2 vs. RF Frequency at Various I_{DLNA} Values, $R_{FIN} = -20$ dBm, $LO = 2$ dBm, $IF = 2000$ MHz, $V_{DLNA} = 4$ V

13141-084

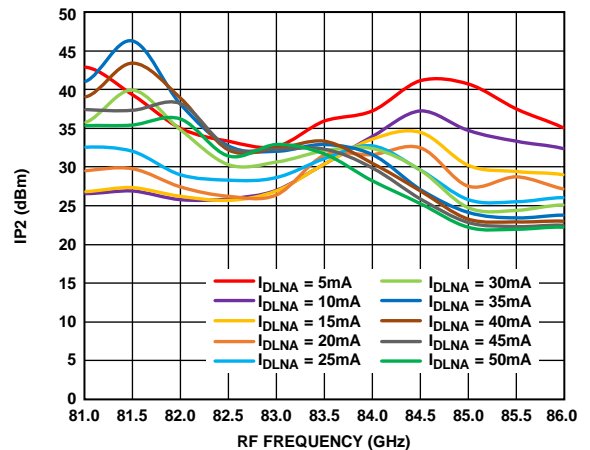

Figure 93. Input IP2 vs. RF Frequency at Various I_{DLNA} Values, $R_{FIN} = -20$ dBm, $LO = 2$ dBm, $IF = 2000$ MHz, $V_{DLNA} = 3$ V

13141-087

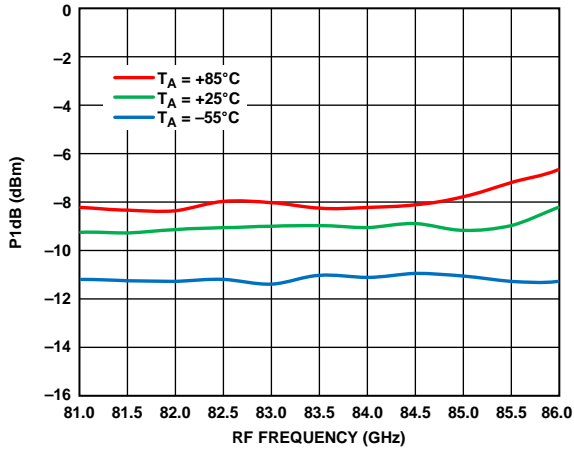

Figure 94. Input P1dB vs. RF Frequency at Various Temperatures, LO = 2 dBm, IF = 2000 MHz, V_{DLNA} = 4 V

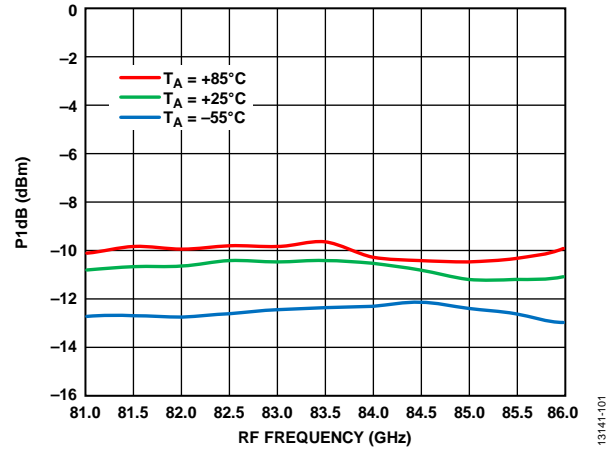

Figure 95. Input P1dB vs. RF Frequency at Various Temperatures, LO = 2 dBm, IF = 2000 MHz, V_{DLNA} = 3 V

13141-098

13141-101

NOISE FIGURE PERFORMANCE WITH UPPER SIDEBAND SELECTED

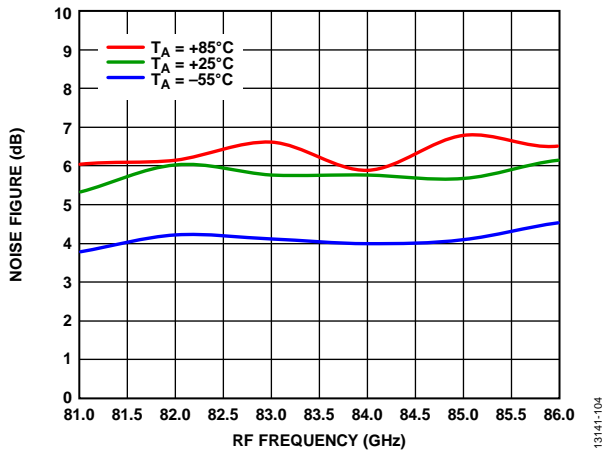

Figure 96. Noise Figure vs. RF Frequency at Various Temperatures, LO = 2 dBm, IF = 500 MHz, V_{DLNA} = 3 V

13141-104

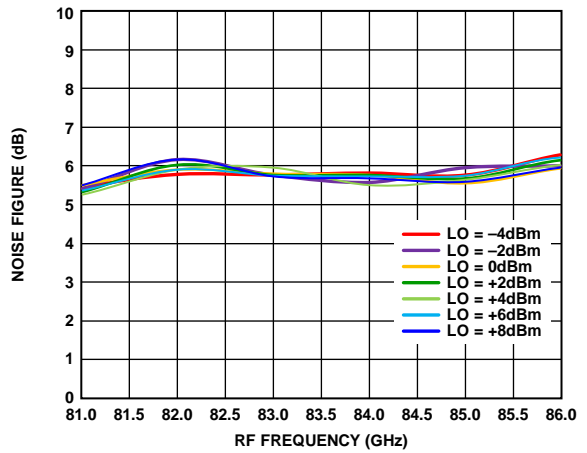

Figure 99. Noise Figure vs. RF Frequency at Various LO Powers, IF = 500 MHz, V_{DLNA} = 3 V

13141-107

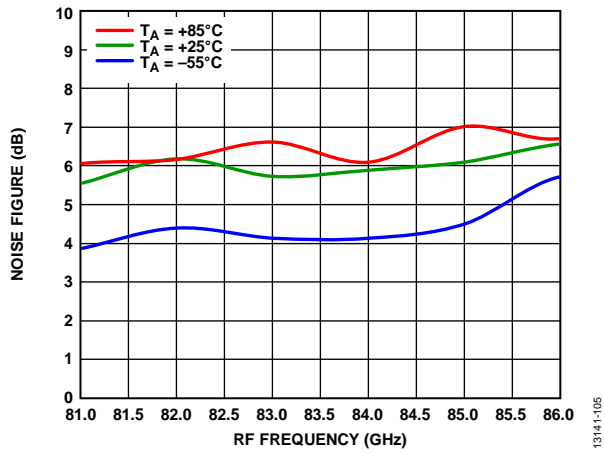

Figure 97. Noise Figure vs. RF Frequency at Various Temperatures, LO = 2 dBm, IF = 1000 MHz, V_{DLNA} = 3 V

13141-105

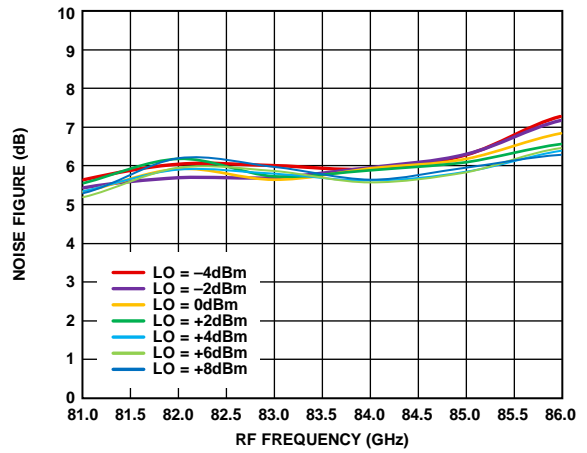

Figure 100. Noise Figure vs. RF Frequency at Various LO Powers, IF = 1000 MHz, V_{DLNA} = 3 V

13141-108

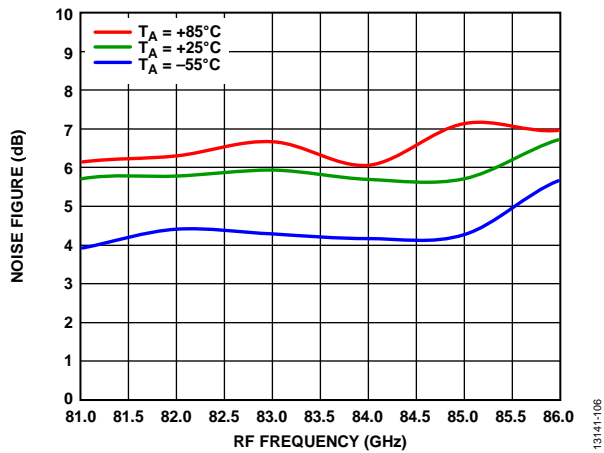

Figure 98. Noise Figure vs. RF Frequency at Various Temperatures, LO = 2 dBm, IF = 2000 MHz, V_{DLNA} = 3 V

13141-106

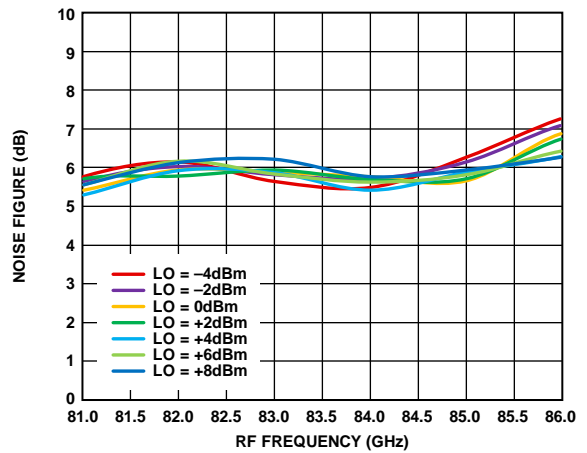

Figure 101. Noise Figure vs. RF Frequency at Various LO Powers, IF = 2000 MHz, V_{DLNA} = 3 V

13141-109

AMPLITUDE BALANCE PERFORMANCE WITH UPPER SIDEBAND SELECTED

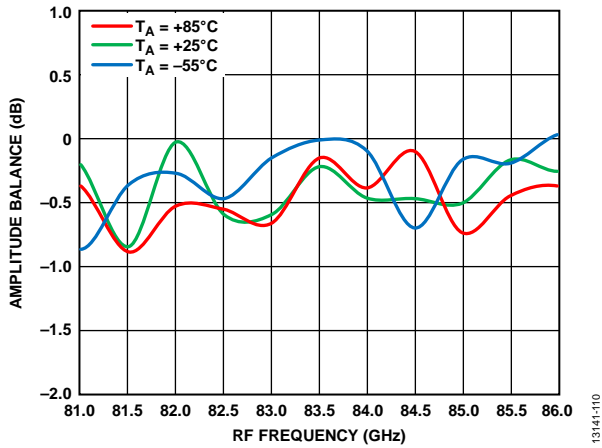

Figure 102. Amplitude Balance vs. RF Frequency at Various Temperatures, RFIN = -20 dBm, LO = 2 dBm, IF = 500 MHz, VDLNA = 4 V

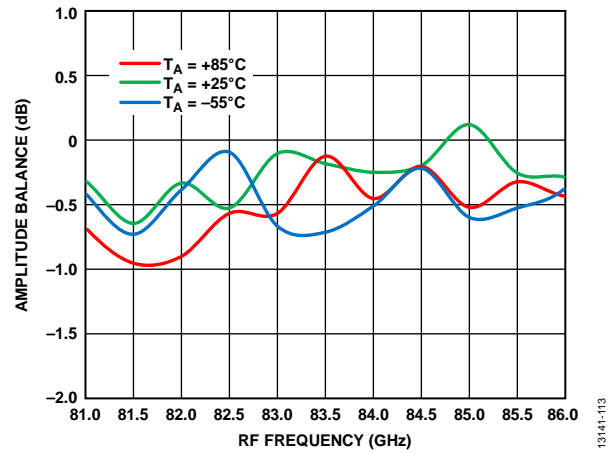

Figure 105. Amplitude Balance vs. RF Frequency at Various Temperatures, RFIN = -20 dBm, LO = 2 dBm, IF = 500 MHz, VDLNA = 3 V

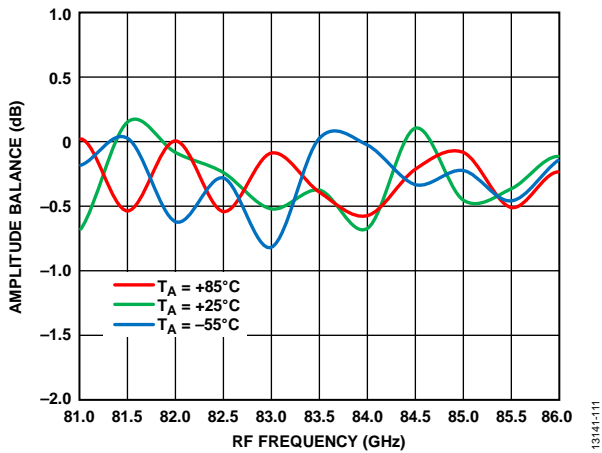

Figure 103. Amplitude Balance vs. RF Frequency at Various Temperatures, RFIN = -20 dBm, LO = 2 dBm, IF = 1000 MHz, VDLNA = 4 V

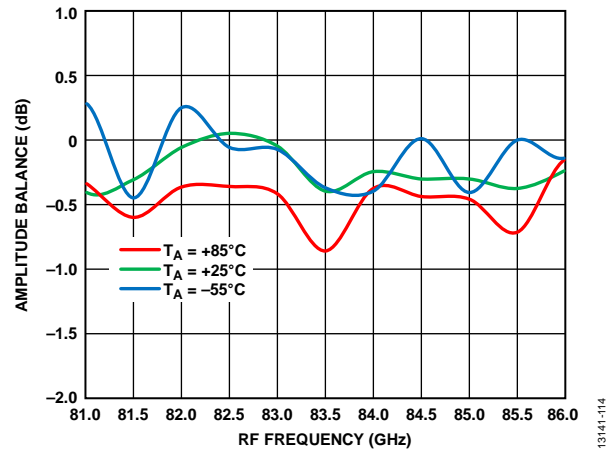

Figure 106. Amplitude Balance vs. RF Frequency at Various Temperatures, RFIN = -20 dBm, LO = 2 dBm, IF = 1000 MHz, VDLNA = 3 V

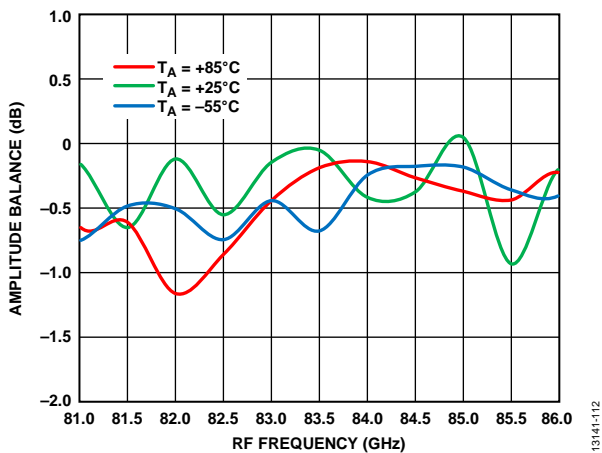

Figure 104. Amplitude Balance vs. RF Frequency at Various Temperatures, RFIN = -20 dBm, LO = 2 dBm, IF = 2000 MHz, VDLNA = 4 V

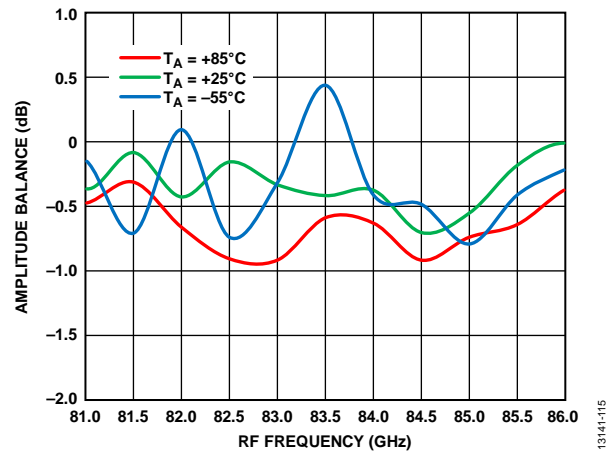

Figure 107. Amplitude Balance vs. RF Frequency at Various Temperatures, RFIN = -20 dBm, LO = 2 dBm, IF = 2000 MHz, VDLNA = 3 V

PHASE BALANCE PERFORMANCE WITH UPPER SIDEBAND SELECTED

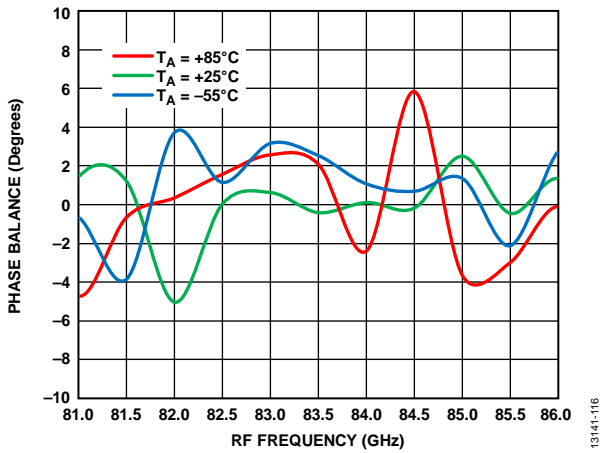

Figure 108. Phase Balance vs. RF Frequency at Various Temperatures, RFIN = -20 dBm, LO = 2 dBm, IF = 500 MHz, VDLNA = 4 V

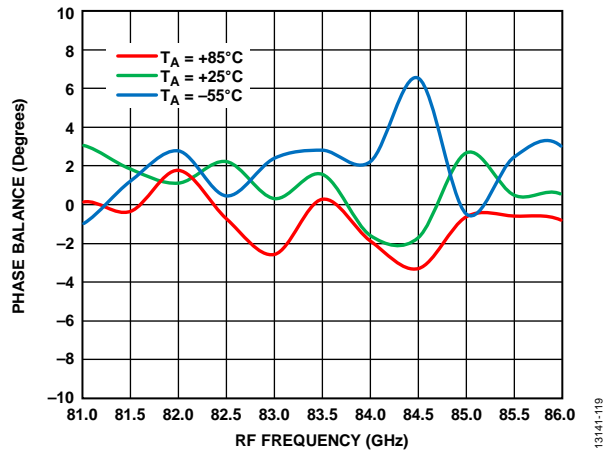

Figure 111. Phase Balance vs. RF Frequency at Various Temperatures, RFIN = -20 dBm, LO = 2 dBm, IF = 500 MHz, VDLNA = 3 V

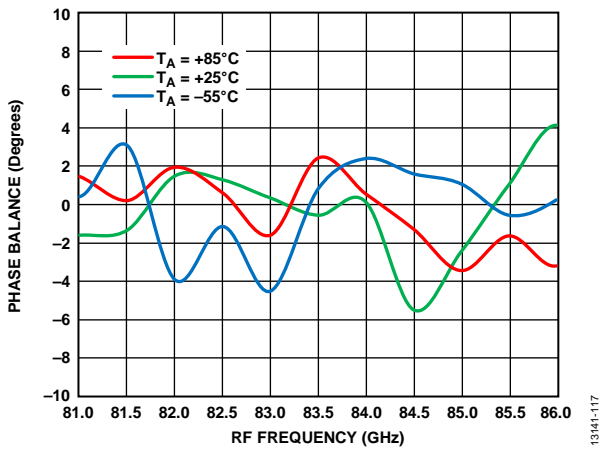

Figure 109. Phase Balance vs. RF Frequency at Various Temperatures, RFIN = -20 dBm, LO = 2 dBm, IF = 1000 MHz, VDLNA = 4 V

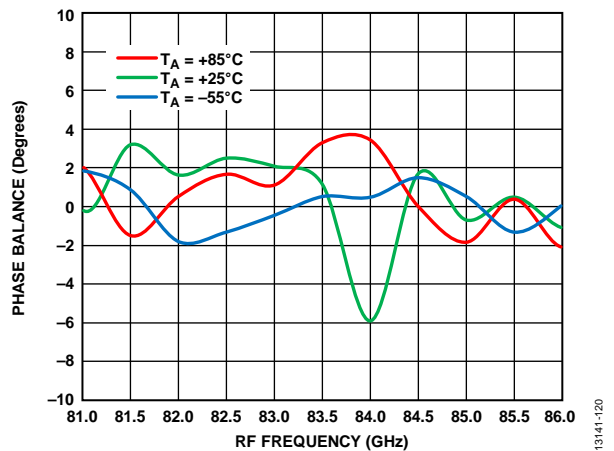

Figure 112. Phase Balance vs. RF Frequency at Various Temperatures, RFIN = -20 dBm, LO = 2 dBm, IF = 1000 MHz, VDLNA = 3 V

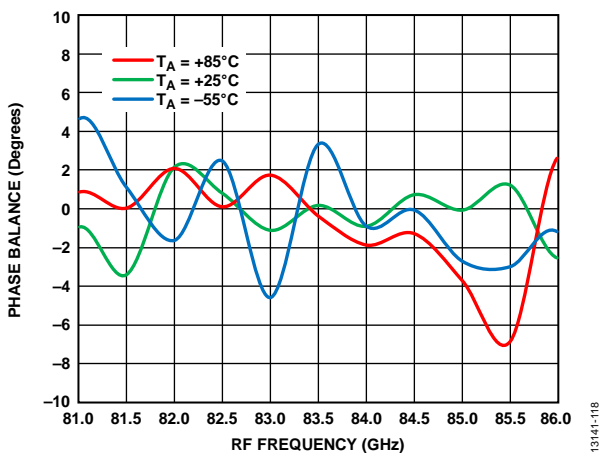

Figure 110. Phase Balance vs. RF Frequency at Various Temperatures, RFIN = -20 dBm, LO = 2 dBm, IF = 2000 MHz, VDLNA = 4 V

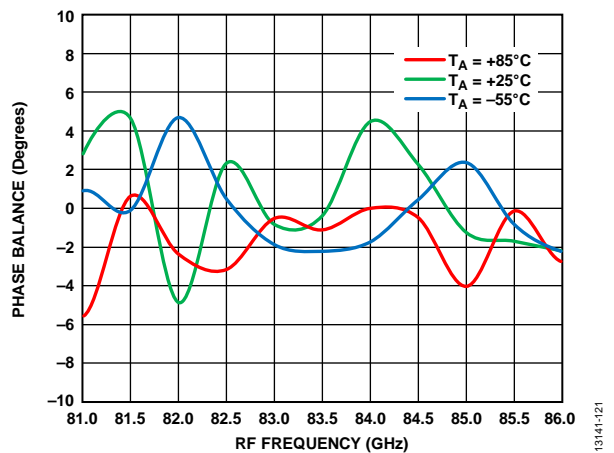

Figure 113. Phase Balance vs. RF Frequency at Various Temperatures, RFIN = -20 dBm, LO = 2 dBm, IF = 2000 MHz, VDLNA = 3 V

LOWER SIDEBAND SELECTED, IF = 500 MHz

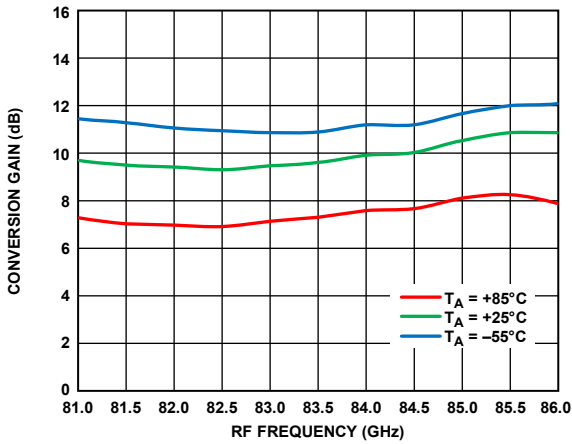

Figure 114. Conversion Gain vs. RF Frequency at Various Temperatures, $R_{FIN} = -20$ dBm, LO = 2 dBm, IF = 500 MHz, $V_{DLNA} = 4$ V

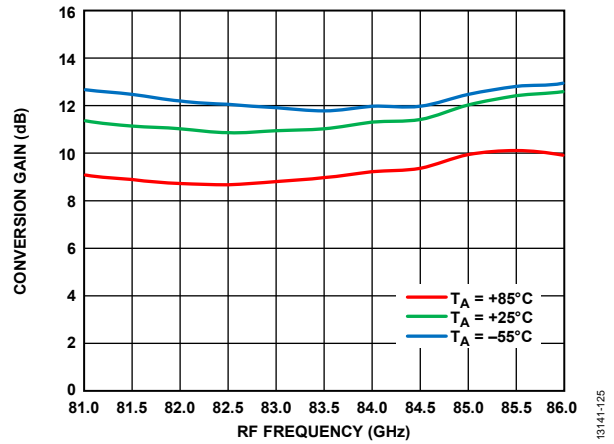

Figure 117. Conversion Gain vs. RF Frequency at Various Temperatures, $R_{FIN} = -20$ dBm, LO = 2 dBm, IF = 500 MHz, $V_{DLNA} = 3$ V

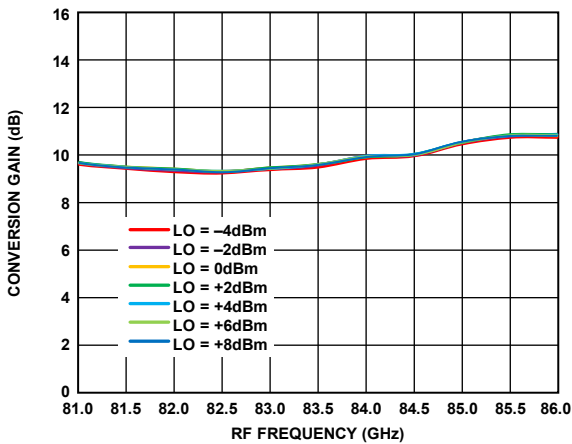

Figure 115. Conversion Gain vs. RF Frequency at Various LO Powers, $R_{FIN} = -20$ dBm, IF = 500 MHz, $V_{DLNA} = 4$ V

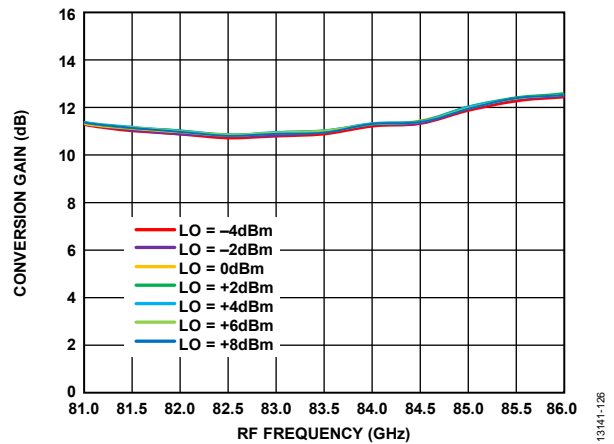

Figure 118. Conversion Gain vs. RF Frequency at Various LO Powers, $R_{FIN} = -20$ dBm, IF = 500 MHz, $V_{DLNA} = 3$ V

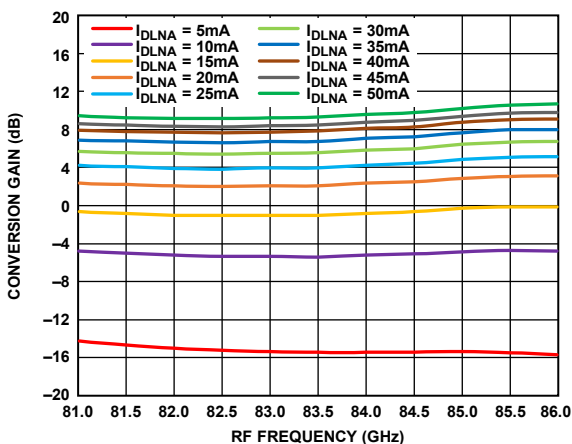

Figure 116. Conversion Gain vs. RF Frequency at Various I_{DLNA} Values, $R_{FIN} = -20$ dBm, LO = 2 dBm, IF = 500 MHz, $V_{DLNA} = 4$ V

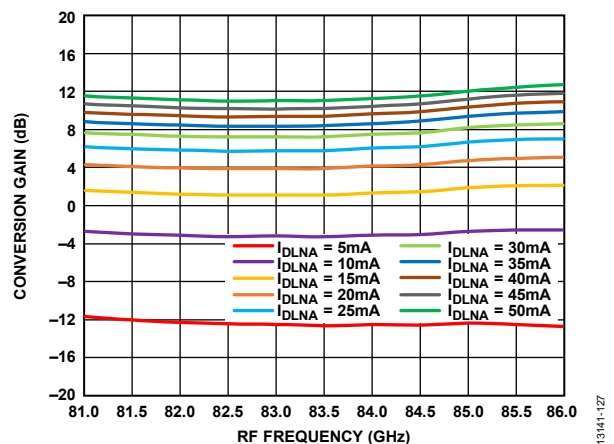

Figure 119. Conversion Gain vs. RF Frequency at Various I_{DLNA} Values, $R_{FIN} = -20$ dBm, LO = 2 dBm, IF = 500 MHz, $V_{DLNA} = 3$ V

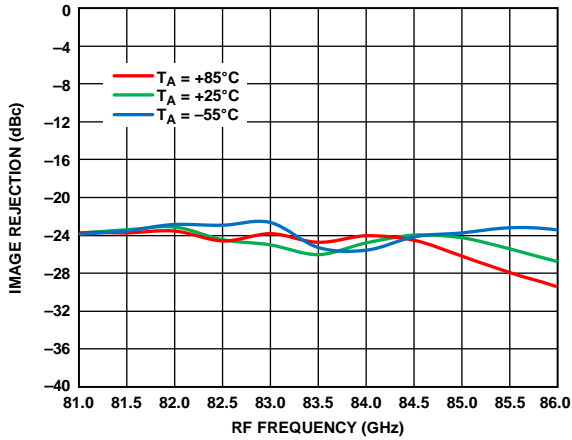

Figure 120. Image Rejection vs. RF Frequency at Various Temperatures, $RFIN = -20\text{ dBm}$, $LO = 2\text{ dBm}$, $IF = 500\text{ MHz}$, $V_{DLNA} = 4\text{ V}$

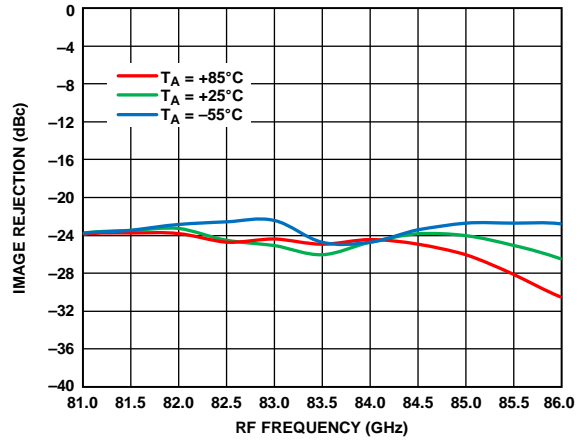

Figure 123. Image Rejection vs. RF Frequency at Various Temperatures, $RFIN = -20\text{ dBm}$, $LO = 2\text{ dBm}$, $IF = 500\text{ MHz}$, $V_{DLNA} = 3\text{ V}$

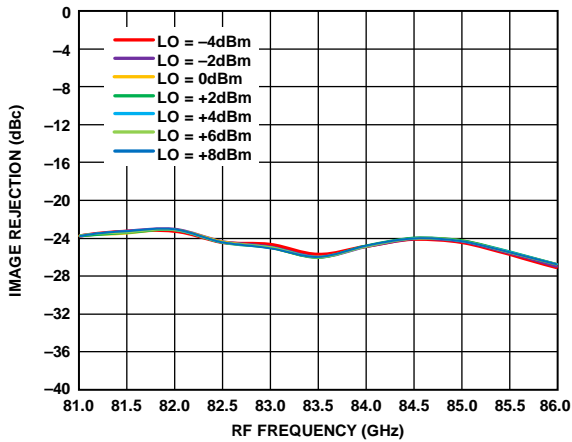

Figure 121. Image Rejection vs. RF Frequency at Various LO Powers, $RFIN = -20\text{ dBm}$, $IF = 500\text{ MHz}$, $V_{DLNA} = 4\text{ V}$

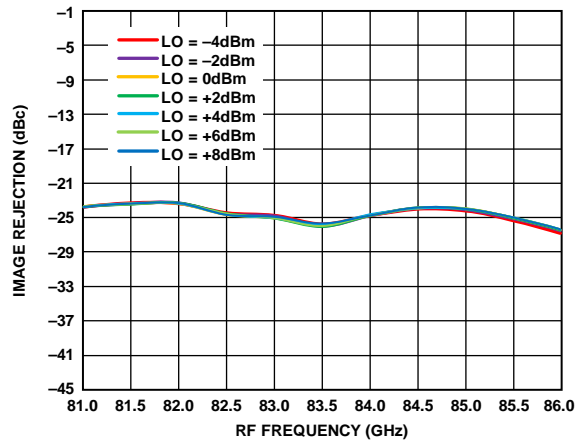

Figure 124. Image Rejection vs. RF Frequency at Various LO Powers, $RFIN = -20\text{ dBm}$, $IF = 500\text{ MHz}$, $V_{DLNA} = 3\text{ V}$

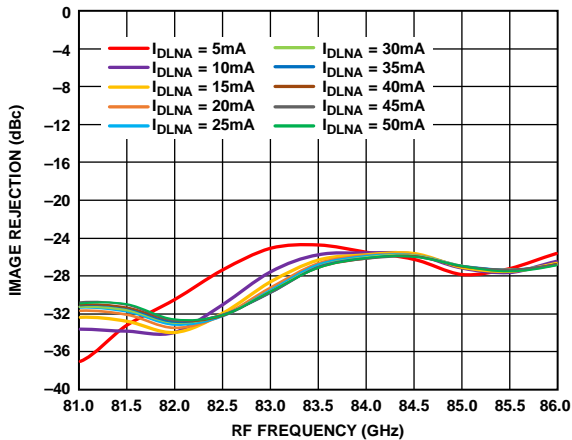

Figure 122. Image Rejection vs. RF Frequency at Various I_{DLNA} Values, $RFIN = -20\text{ dBm}$, $LO = 2\text{ dBm}$, $IF = 500\text{ MHz}$, $V_{DLNA} = 4\text{ V}$

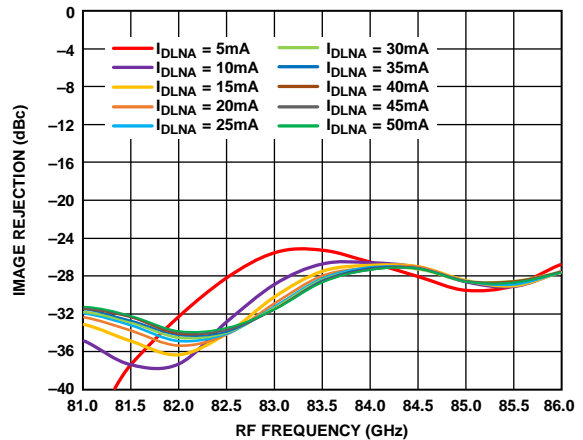
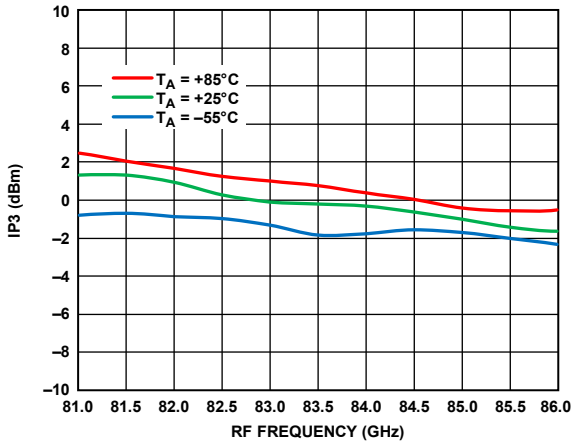
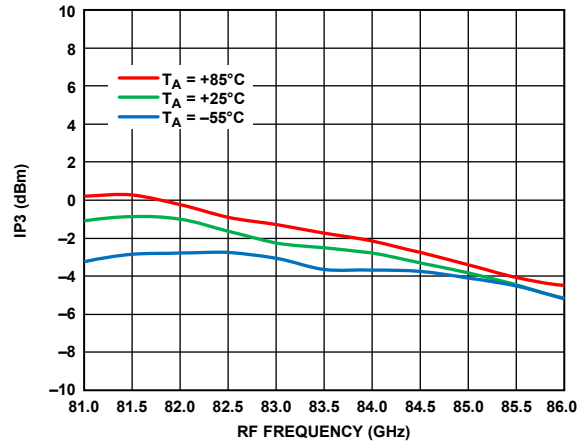

Figure 125. Image Rejection vs. RF Frequency at Various I_{DLNA} Values, $RFIN = -20\text{ dBm}$, $LO = 2\text{ dBm}$, $IF = 500\text{ MHz}$, $V_{DLNA} = 3\text{ V}$



131441-134

Figure 126. Input IP3 vs. RF Frequency at Various Temperatures, $R_{FIN} = -20$ dBm, LO = 2 dBm, IF = 500 MHz, $V_{DLNA} = 4$ V



131441-137

Figure 129. Input IP3 vs. RF Frequency at Various Temperatures, $R_{FIN} = -20$ dBm, LO = 2 dBm, IF = 500 MHz, $V_{DLNA} = 3$ V

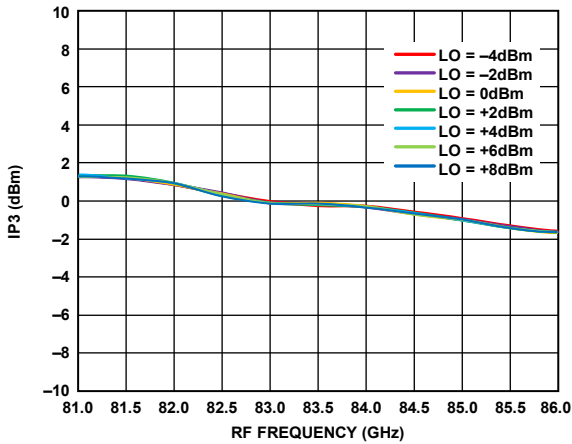

131441-135

Figure 127. Input IP3 vs. RF Frequency at Various LO Powers, $R_{FIN} = -20$ dBm, IF = 500 MHz, $V_{DLNA} = 4$ V

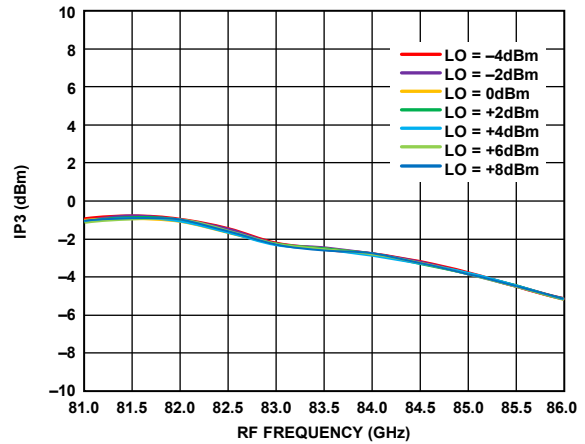

131441-138

Figure 130. Input IP3 vs. RF Frequency at Various LO Powers, $R_{FIN} = -20$ dBm, IF = 500 MHz, $V_{DLNA} = 3$ V

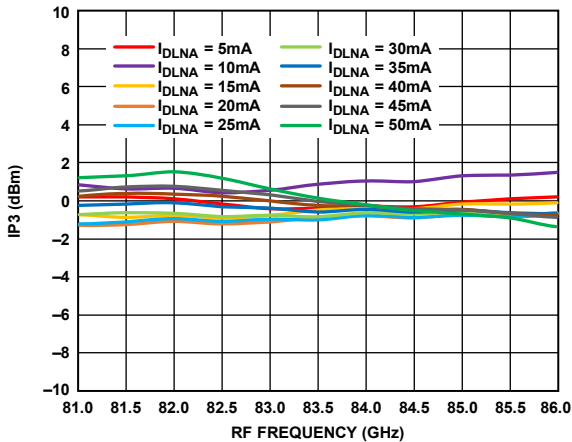

131441-136

Figure 128. Input IP3 vs. RF Frequency at Various I_{DLNA} Values, $R_{FIN} = -20$ dBm, LO = 2 dBm, IF = 500 MHz, $V_{DLNA} = 4$ V

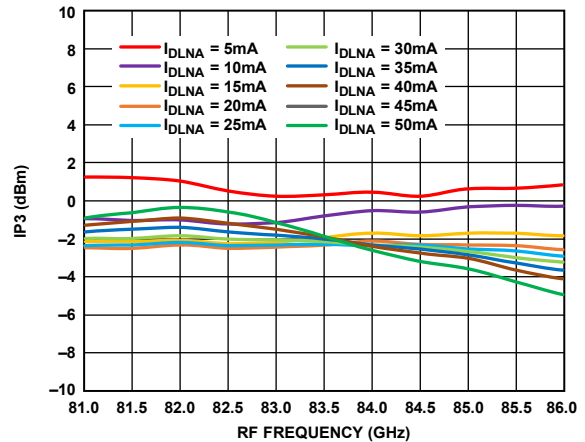

131441-139

Figure 131. Input IP3 vs. RF Frequency at Various I_{DLNA} Values, $R_{FIN} = -20$ dBm, LO = 2 dBm, IF = 500 MHz, $V_{DLNA} = 3$ V

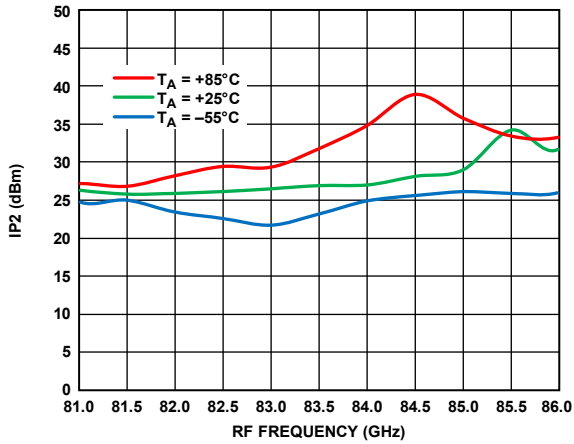

Figure 132. Input IP2 vs. RF Frequency at Various Temperatures, $R_{FIN} = -20$ dBm, $LO = 2$ dBm, $IF = 500$ MHz, $V_{DLNA} = 4$ V

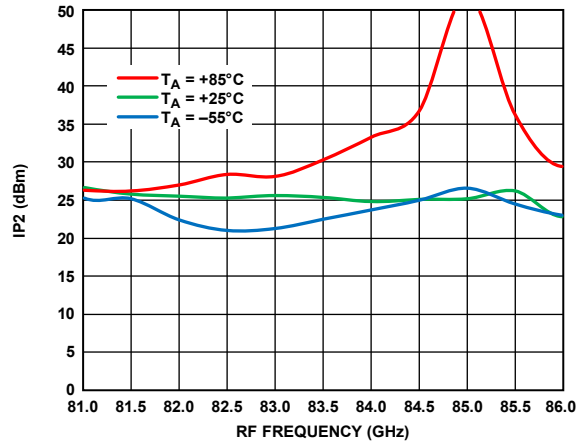

Figure 135. Input IP2 vs. RF Frequency at Various Temperatures, $R_{FIN} = -20$ dBm, $LO = 2$ dBm, $IF = 500$ MHz, $V_{DLNA} = 3$ V

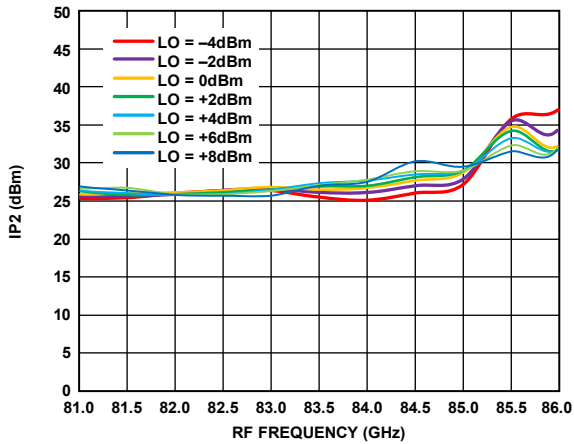

Figure 133. Input IP2 vs. RF Frequency at Various LO Powers, $R_{FIN} = -20$ dBm, $IF = 500$ MHz, $V_{DLNA} = 4$ V

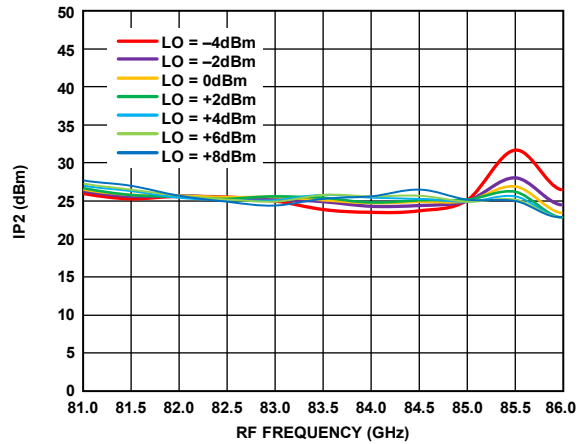

Figure 136. Input IP2 vs. RF Frequency at Various LO Powers, $R_{FIN} = -20$ dBm, $IF = 500$ MHz, $V_{DLNA} = 3$ V

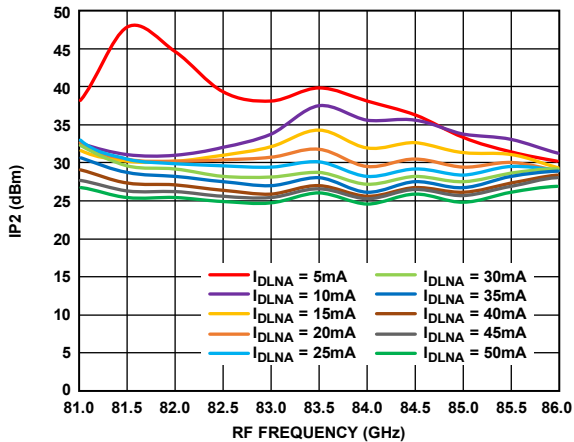

Figure 134. Input IP2 vs. RF Frequency at Various I_{DLNA} Values, $R_{FIN} = -20$ dBm, $LO = 2$ dBm, $IF = 500$ MHz, $V_{DLNA} = 4$ V

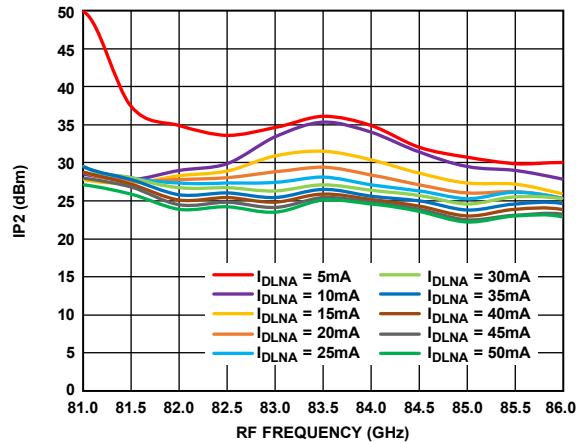

Figure 137. Input IP2 vs. RF Frequency at Various I_{DLNA} Values, $R_{FIN} = -20$ dBm, $LO = 2$ dBm, $IF = 500$ MHz, $V_{DLNA} = 3$ V

13141-140

13141-143

13141-141

13141-144

13141-142

13141-145

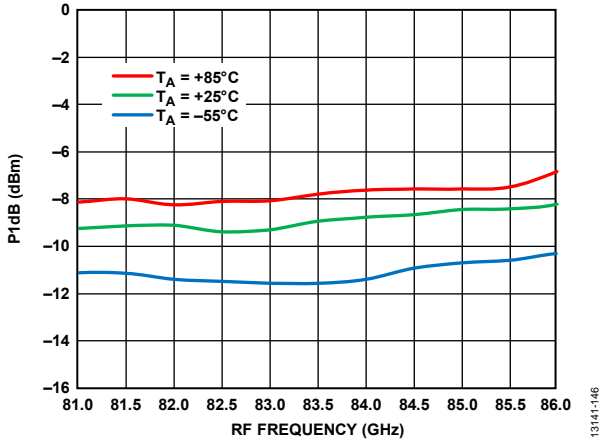

Figure 138. Input P1dB vs. RF Frequency at Various Temperatures, LO = 2 dBm, IF = 500 MHz, V_{DLNA} = 4 V

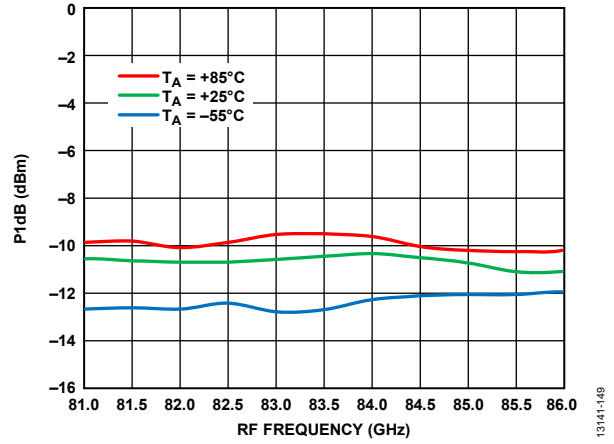

Figure 139. Input P1dB vs. RF Frequency at Various Temperatures, LO = 2 dBm, IF = 500 MHz, V_{DLNA} = 3 V

13141-146

13141-146

LOWER SIDEBAND SELECTED, IF = 1000 MHz

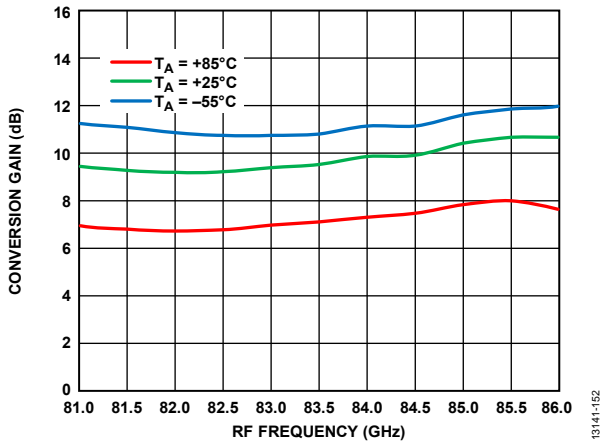

Figure 140. Conversion Gain vs. RF Frequency at Various Temperatures, $R_{FIN} = -20$ dBm, $L_O = 2$ dBm, $I_F = 1000$ MHz, $V_{DLNA} = 4$ V

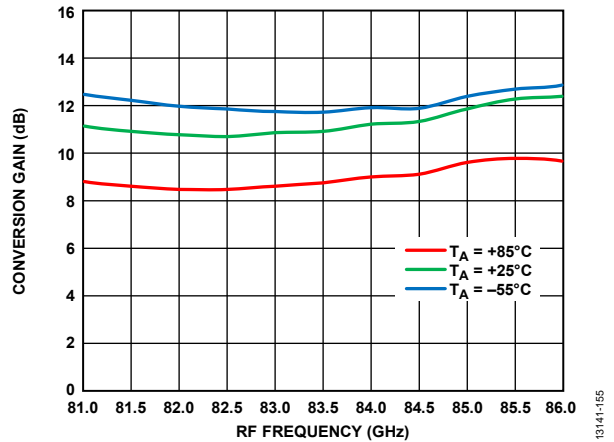

Figure 143. Conversion Gain vs. RF Frequency at Various Temperatures, $R_{FIN} = -20$ dBm, $L_O = 2$ dBm, $I_F = 1000$ MHz, $V_{DLNA} = 3$ V

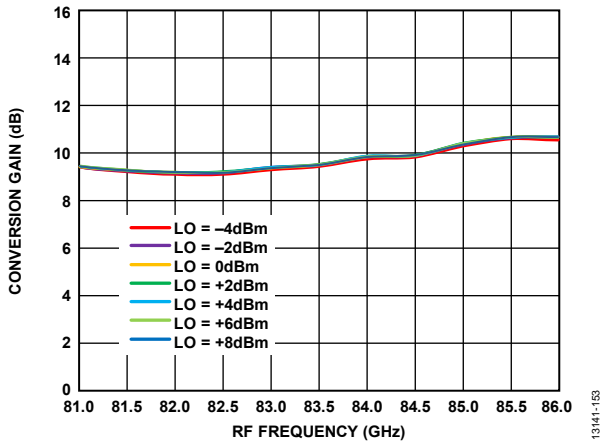

Figure 141. Conversion Gain vs. RF Frequency at Various LO Powers, $R_{FIN} = -20$ dBm, $I_F = 1000$ MHz, $V_{DLNA} = 4$ V

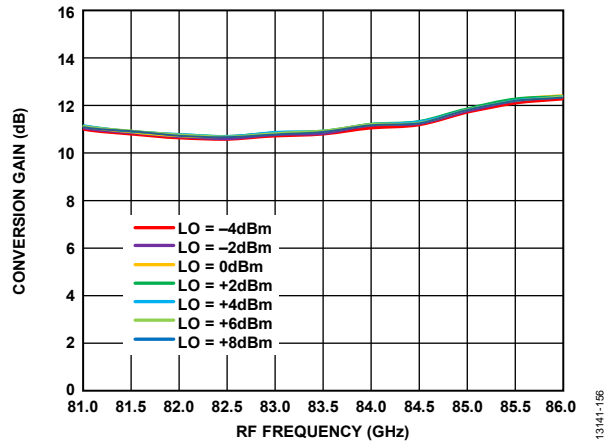

Figure 144. Conversion Gain vs. RF Frequency at Various LO Powers, $R_{FIN} = -20$ dBm, $I_F = 1000$ MHz, $V_{DLNA} = 3$ V

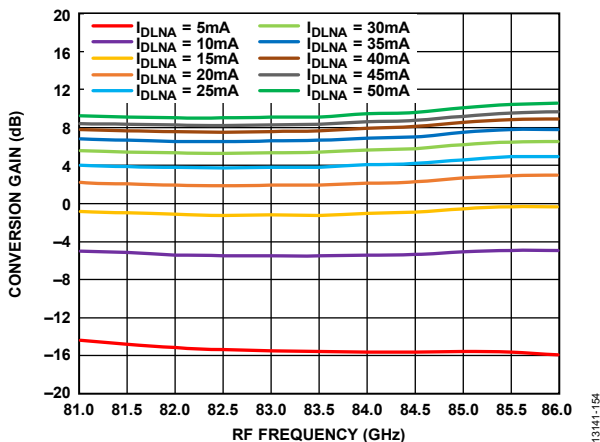

Figure 142. Conversion Gain vs. RF Frequency at Various I_{DLNA} Values, $R_{FIN} = -20$ dBm, $L_O = 2$ dBm, $I_F = 1000$ MHz, $V_{DLNA} = 4$ V

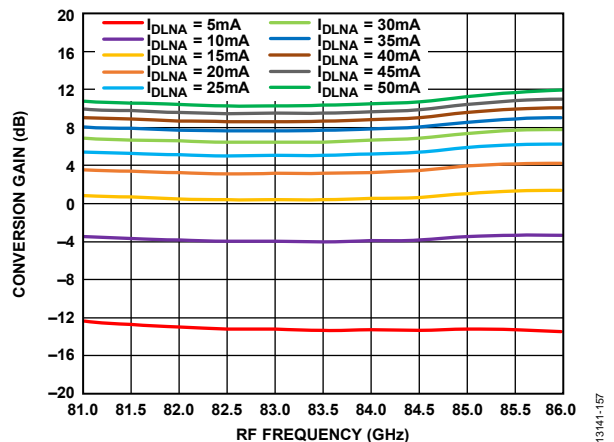

Figure 145. Conversion Gain vs. RF Frequency at Various I_{DLNA} Values, $R_{FIN} = -20$ dBm, $L_O = 2$ dBm, $I_F = 1000$ MHz, $V_{DLNA} = 3$ V

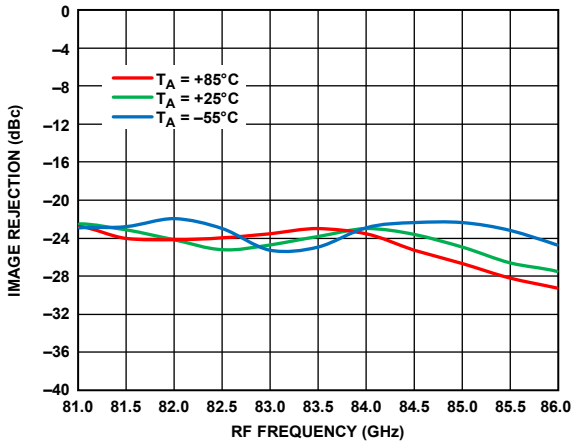

Figure 146. Image Rejection vs. RF Frequency at Various Temperatures, $R_{FIN} = -20$ dBm, $LO = 2$ dBm, $IF = 1000$ MHz, $V_{DLNA} = 4$ V

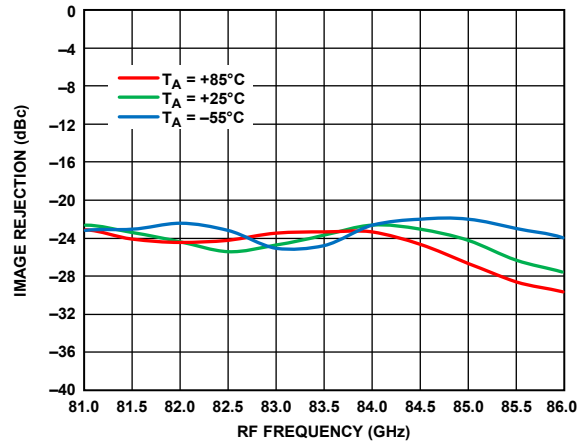

Figure 149. Image Rejection vs. RF Frequency at Various Temperatures, $R_{FIN} = -20$ dBm, $LO = 2$ dBm, $IF = 1000$ MHz, $V_{DLNA} = 3$ V

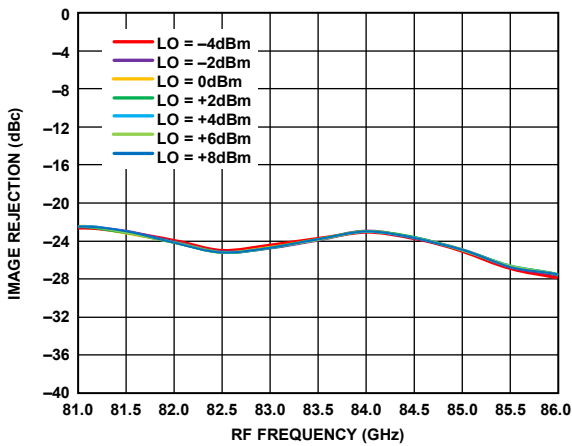

Figure 147. Image Rejection vs. RF Frequency at Various LO Powers, $R_{FIN} = -20$ dBm, $IF = 1000$ MHz, $V_{DLNA} = 4$ V

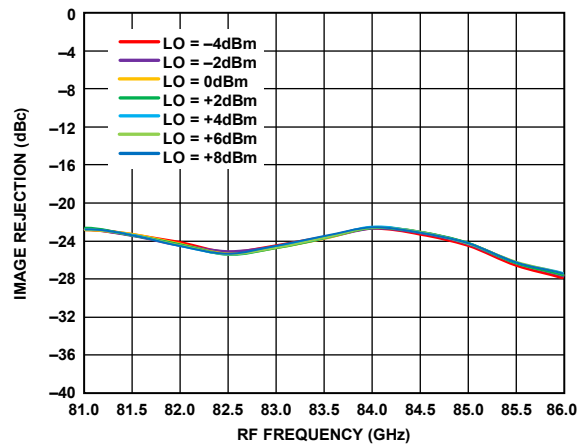

Figure 150. Image Rejection vs. RF Frequency at Various LO Powers, $R_{FIN} = -20$ dBm, $IF = 1000$ MHz, $V_{DLNA} = 3$ V

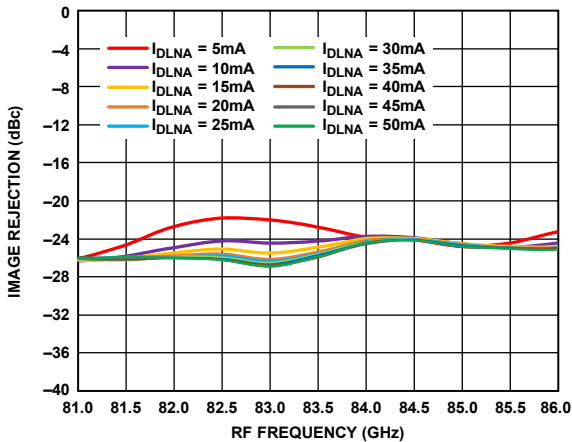

Figure 148. Image Rejection vs. RF Frequency at Various I_{DLNA} Values, $R_{FIN} = -20$ dBm, $LO = 2$ dBm, $IF = 1000$ MHz, $V_{DLNA} = 4$ V

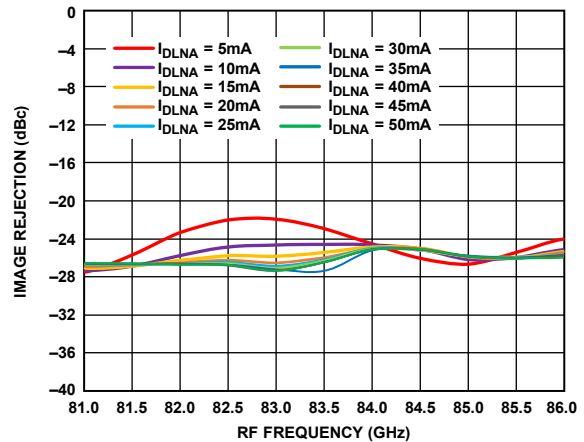

Figure 151. Image Rejection vs. RF Frequency at Various I_{DLNA} Values, $R_{FIN} = -20$ dBm, $LO = 2$ dBm, $IF = 1000$ MHz, $V_{DLNA} = 3$ V

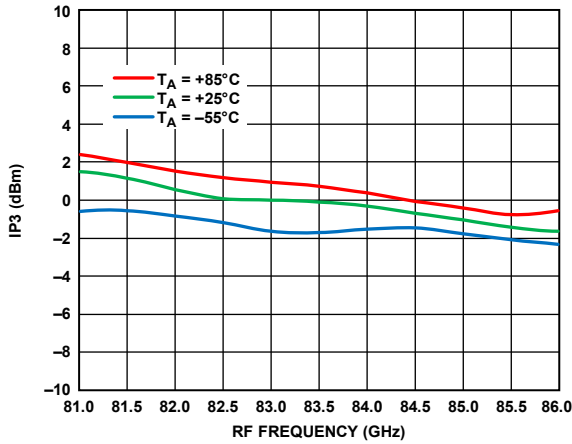

Figure 152. Input IP3 vs. RF Frequency at Various Temperatures, $R_{FIN} = -20$ dBm, $LO = 2$ dBm, $IF = 1000$ MHz, $V_{DLNA} = 4$ V

13141-164

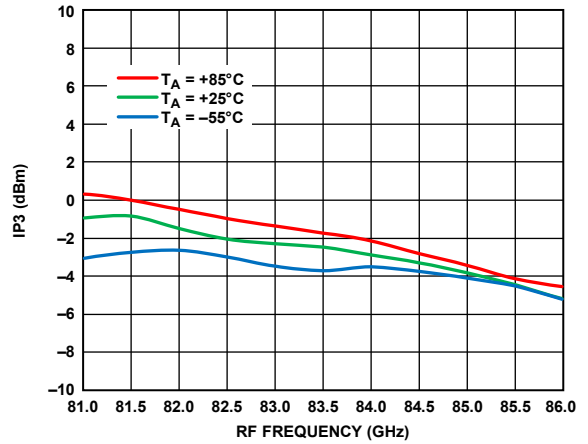

Figure 155. Input IP3 vs. RF Frequency at Various Temperatures, $R_{FIN} = -20$ dBm, $LO = 2$ dBm, $IF = 1000$ MHz, $V_{DLNA} = 3$ V

13141-167

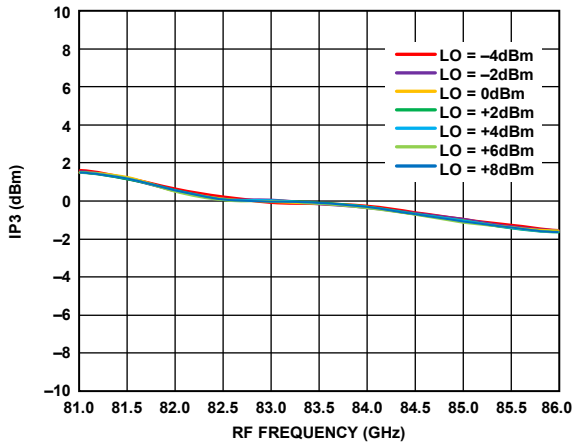

Figure 153. Input IP3 vs. RF Frequency at Various LO Powers, $R_{FIN} = -20$ dBm, $IF = 1000$ MHz, $V_{DLNA} = 4$ V

13141-165

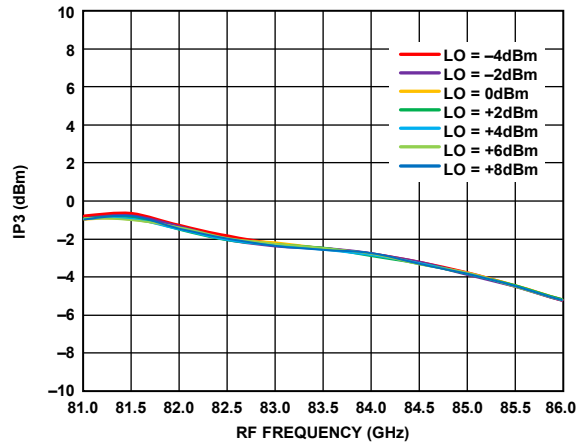

Figure 156. Input IP3 vs. RF Frequency at Various LO Powers, $R_{FIN} = -20$ dBm, $IF = 1000$ MHz, $V_{DLNA} = 3$ V

13141-168

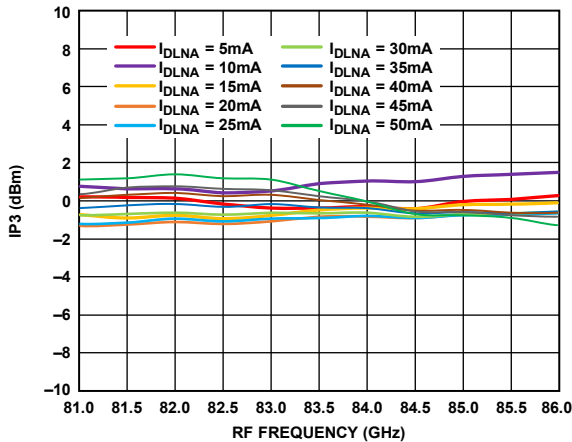

Figure 154. Input IP3 vs. RF Frequency at Various I_{DLNA} Values, $R_{FIN} = -20$ dBm, $LO = 2$ dBm, $IF = 1000$ MHz, $V_{DLNA} = 4$ V

13141-166

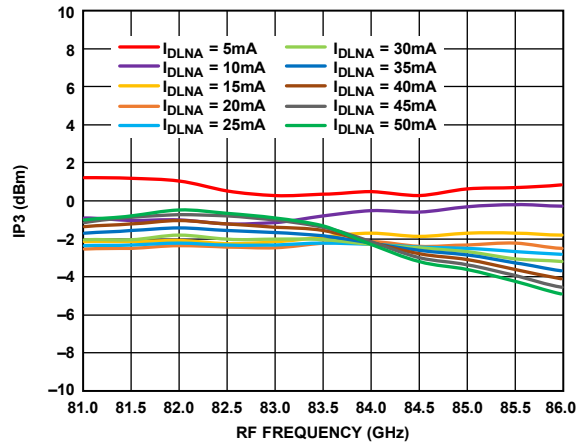
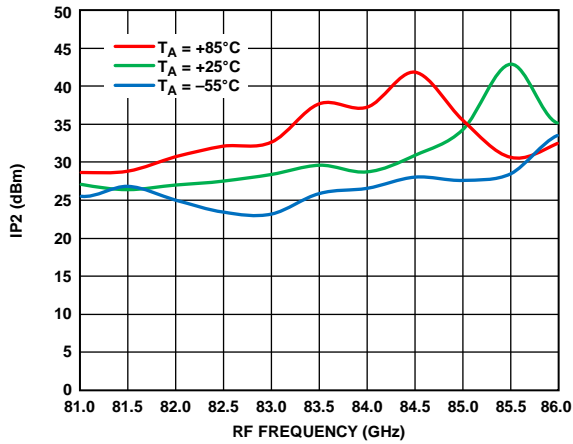

Figure 157. Input IP3 vs. RF Frequency at Various I_{DLNA} Values, $R_{FIN} = -20$ dBm, $LO = 2$ dBm, $IF = 1000$ MHz, $V_{DLNA} = 3$ V

13141-169



13141-170

Figure 158. Input IP2 vs. RF Frequency at Various Temperatures, $R_{FIN} = -20$ dBm, LO = 2 dBm, IF = 1000 MHz, $V_{DLNA} = 4$ V

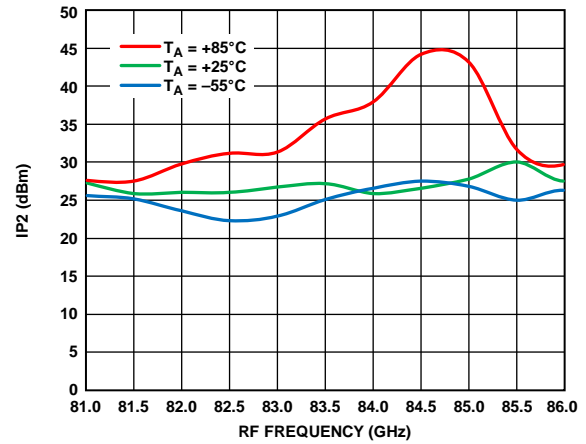

13141-173

Figure 161. Input IP2 vs. RF Frequency at Various Temperatures, $R_{FIN} = -20$ dBm, LO = 2 dBm, IF = 1000 MHz, $V_{DLNA} = 3$ V

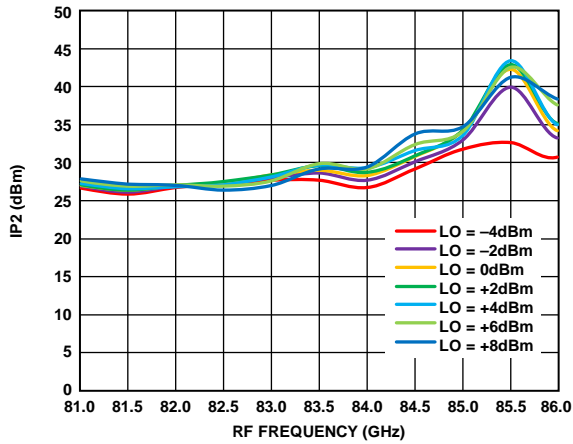

13141-171

Figure 159. Input IP2 vs. RF Frequency at Various LO Powers, $R_{FIN} = -20$ dBm, IF = 1000 MHz, $V_{DLNA} = 4$ V

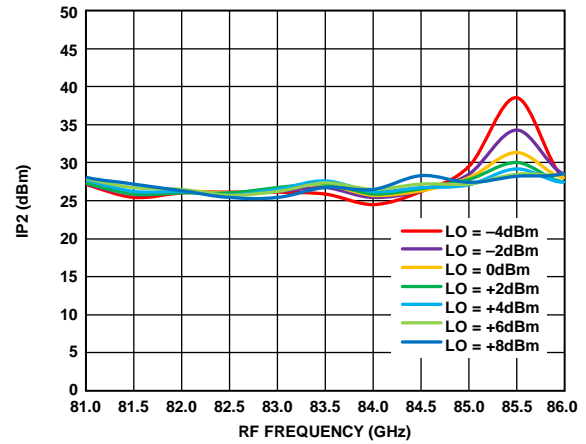

13141-174

Figure 162. Input IP2 vs. RF Frequency at Various LO Powers, $R_{FIN} = -20$ dBm, IF = 1000 MHz, $V_{DLNA} = 3$ V

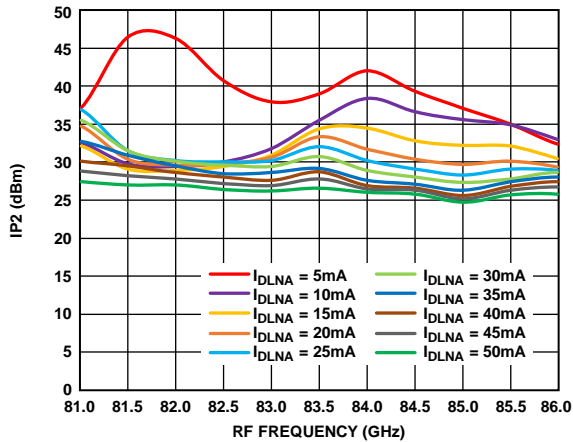

13141-172

Figure 160. Input IP2 vs. RF Frequency at Various I_{DLNA} Values, $R_{FIN} = -20$ dBm, LO = 2 dBm, IF = 1000 MHz, $V_{DLNA} = 4$ V

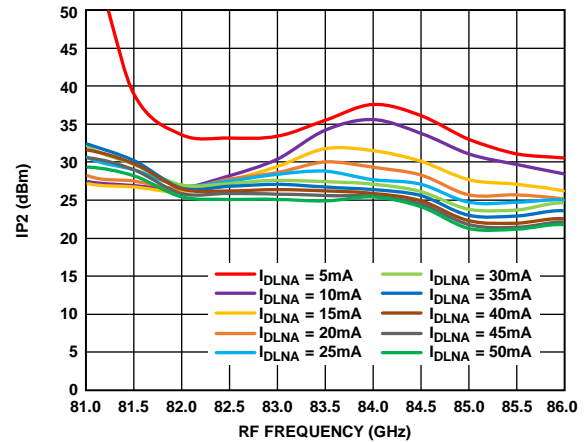

13141-175

Figure 163. Input IP2 vs. RF Frequency at Various I_{DLNA} Values, $R_{FIN} = -20$ dBm, LO = 2 dBm, IF = 1000 MHz, $V_{DLNA} = 3$ V

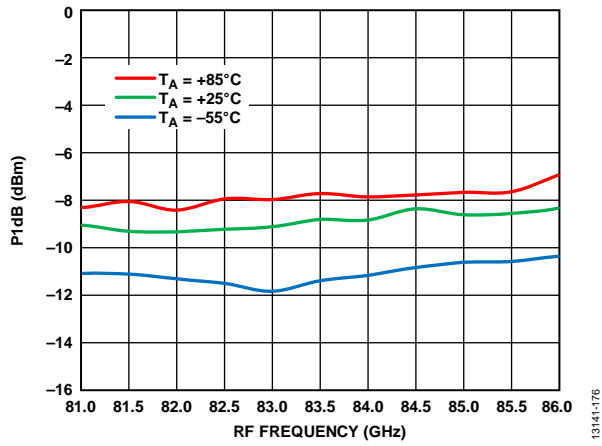

Figure 164. Input P1dB vs. RF Frequency at Various Temperatures, LO = 2 dBm, IF = 1000 MHz, $V_{DLNA} = 4\text{ V}$

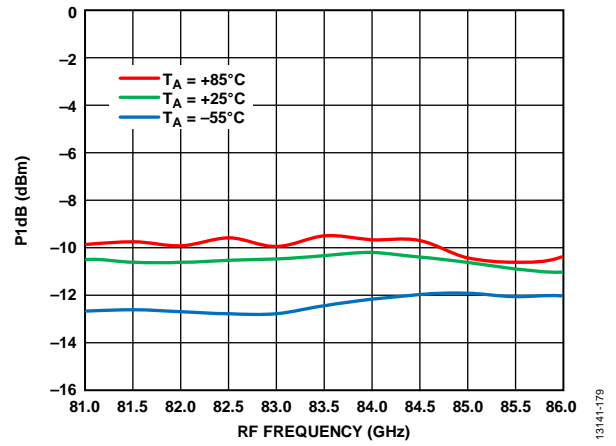

Figure 165. Input P1dB vs. RF Frequency at Various Temperatures, LO = 2 dBm, IF = 1000 MHz, $V_{DLNA} = 3\text{ V}$

LOWER SIDEBAND SELECTED, IF = 2000 MHz

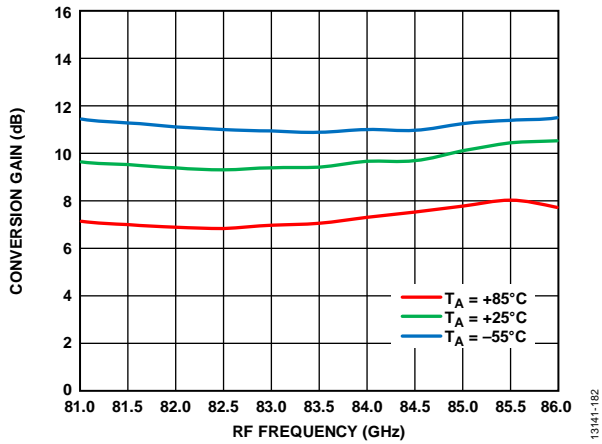

Figure 166. Conversion Gain vs. RF Frequency at Various Temperatures, $RFIN = -20$ dBm, $LO = 2$ dBm, $IF = 2000$ MHz, $V_{DLNA} = 4$ V

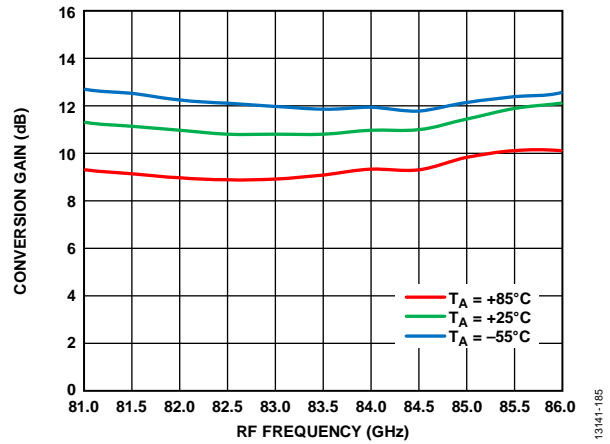

Figure 169. Conversion Gain vs. RF Frequency at Various Temperatures, $RFIN = -20$ dBm, $LO = 2$ dBm, $IF = 2000$ MHz, $V_{DLNA} = 3$ V

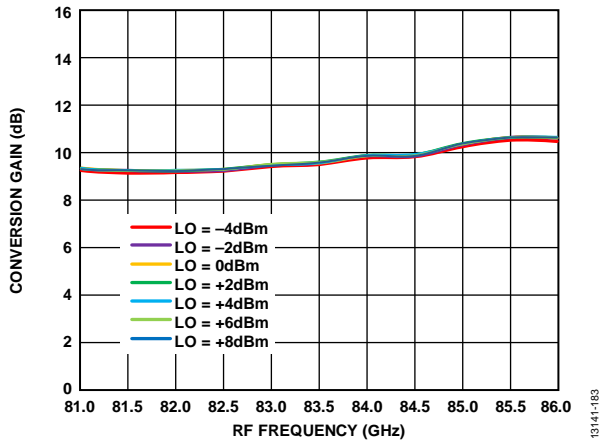

Figure 167. Conversion Gain vs. RF Frequency at Various LO Powers, $RFIN = -20$ dBm, $IF = 2000$ MHz, $V_{DLNA} = 4$ V

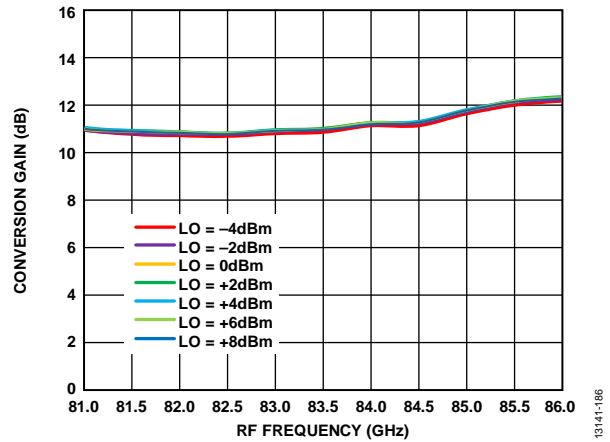

Figure 170. Conversion Gain vs. RF Frequency at Various LO Powers, $RFIN = -20$ dBm, $IF = 2000$ MHz, $V_{DLNA} = 3$ V

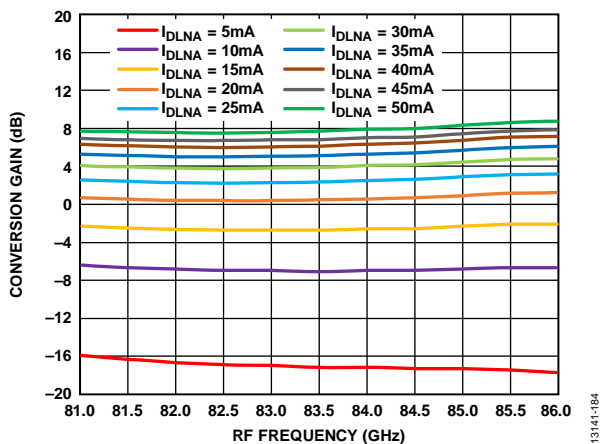

Figure 168. Conversion Gain vs. RF Frequency at Various $IDLNA$ Values, $RFIN = -20$ dBm, $LO = 2$ dBm, $IF = 2000$ MHz, $V_{DLNA} = 4$ V

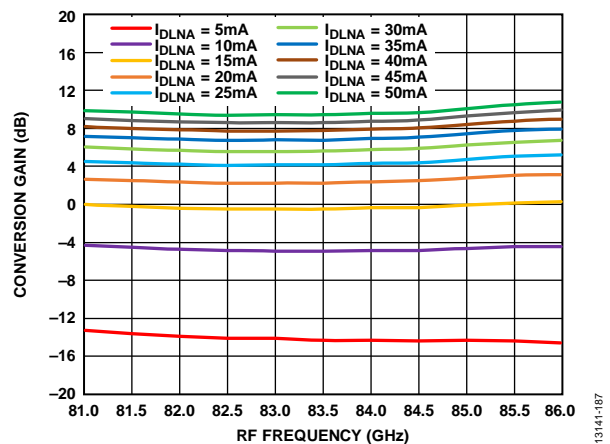

Figure 171. Conversion Gain vs. RF Frequency at Various $IDLNA$ Values, $RFIN = -20$ dBm, $LO = 2$ dBm, $IF = 2000$ MHz, $V_{DLNA} = 3$ V

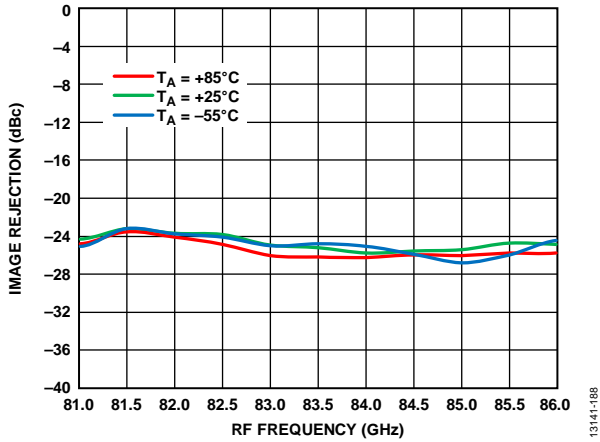

Figure 172. Image Rejection vs. RF Frequency at Various Temperatures, $RFIN = -20\text{ dBm}$, $LO = 2\text{ dBm}$, $IF = 2000\text{ MHz}$, $V_{DLNA} = 4\text{ V}$

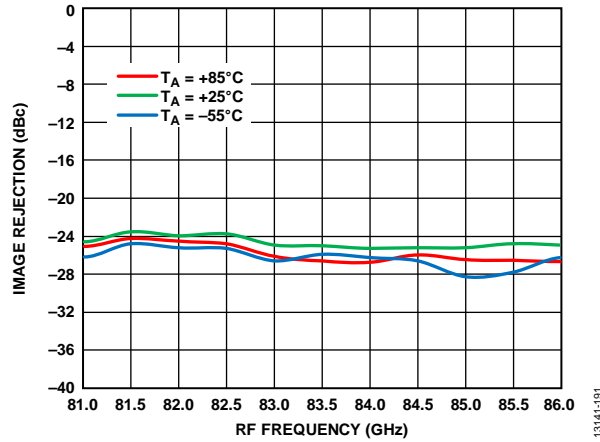

Figure 175. Image Rejection vs. RF Frequency at Various Temperatures, $RFIN = -20\text{ dBm}$, $LO = 2\text{ dBm}$, $IF = 2000\text{ MHz}$, $V_{DLNA} = 3\text{ V}$

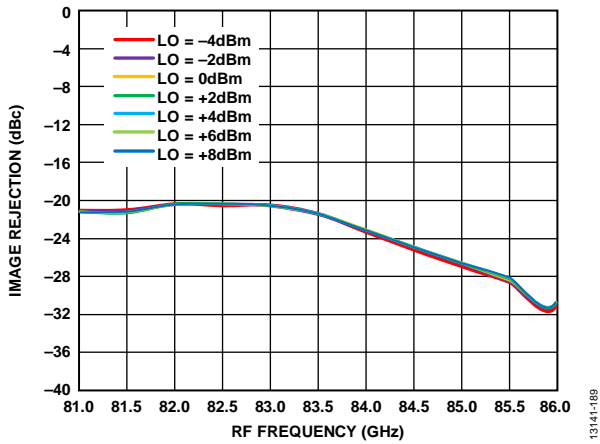

Figure 173. Image Rejection vs. RF Frequency at Various LO Powers, $RFIN = -20\text{ dBm}$, $IF = 2000\text{ MHz}$, $V_{DLNA} = 4\text{ V}$

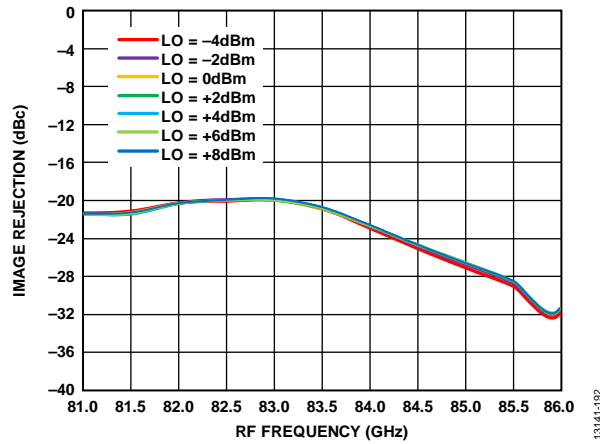

Figure 176. Image Rejection vs. RF Frequency at Various LO Powers, $RFIN = -20\text{ dBm}$, $IF = 2000\text{ MHz}$, $V_{DLNA} = 3\text{ V}$

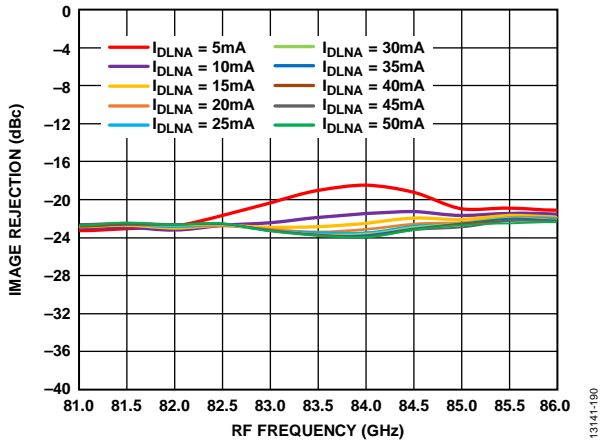

Figure 174. Image Rejection vs. RF Frequency at Various I_{DLNA} Values, $RFIN = -20\text{ dBm}$, $LO = 2\text{ dBm}$, $IF = 2000\text{ MHz}$, $V_{DLNA} = 4\text{ V}$

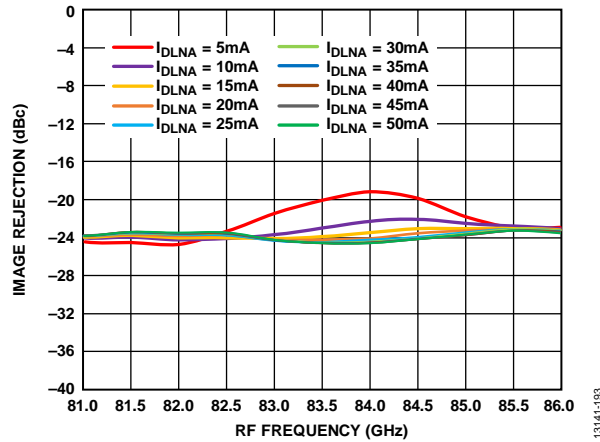
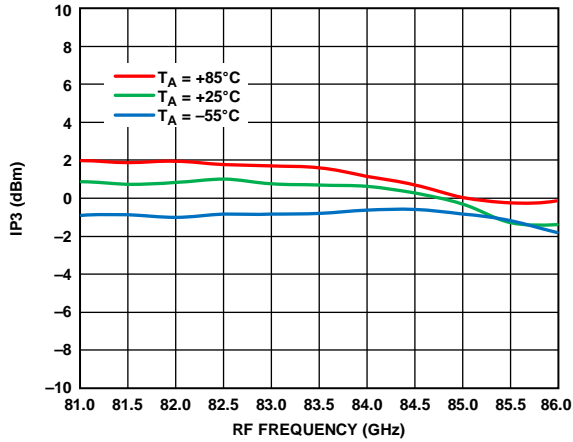
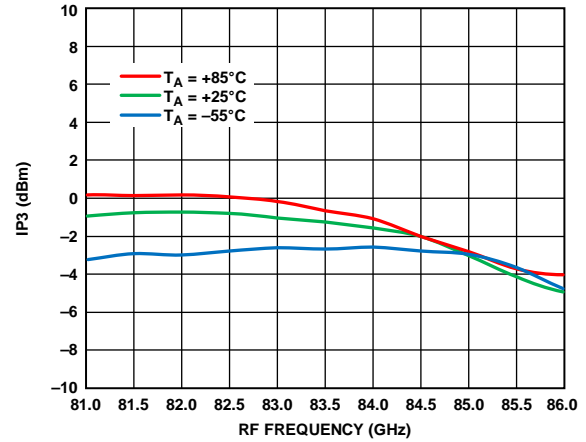

Figure 177. Image Rejection vs. RF Frequency at Various I_{DLNA} Values, $RFIN = -20\text{ dBm}$, $LO = 2\text{ dBm}$, $IF = 2000\text{ MHz}$, $V_{DLNA} = 3\text{ V}$



13141-194

Figure 178. Input IP3 vs. RF Frequency at Various Temperatures, $R_{FIN} = -20$ dBm, $LO = 2$ dBm, $IF = 2000$ MHz, $V_{DLNA} = 4$ V



13141-197

Figure 181. Input IP3 vs. RF Frequency at Various Temperatures, $R_{FIN} = -20$ dBm, $LO = 2$ dBm, $IF = 2000$ MHz, $V_{DLNA} = 3$ V

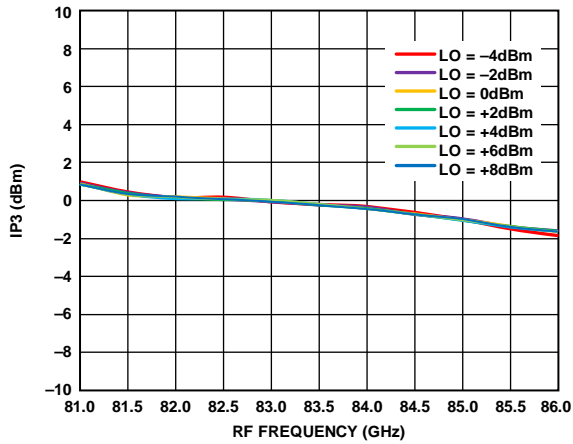

13141-195

Figure 179. Input IP3 vs. RF Frequency at Various LO Powers, $R_{FIN} = -20$ dBm, $IF = 2000$ MHz, $V_{DLNA} = 4$ V

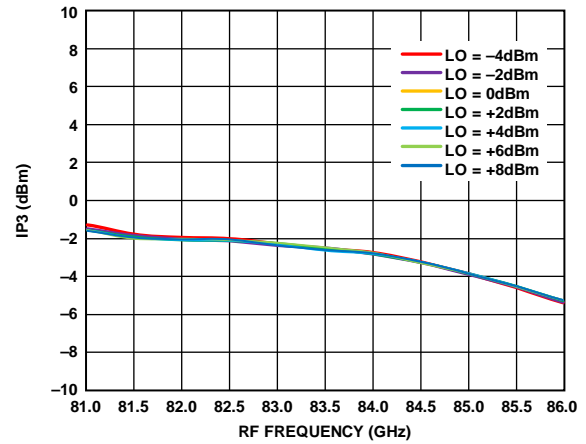

13141-198

Figure 182. Input IP3 vs. RF Frequency at Various LO Powers, $R_{FIN} = -20$ dBm, $IF = 2000$ MHz, $V_{DLNA} = 3$ V

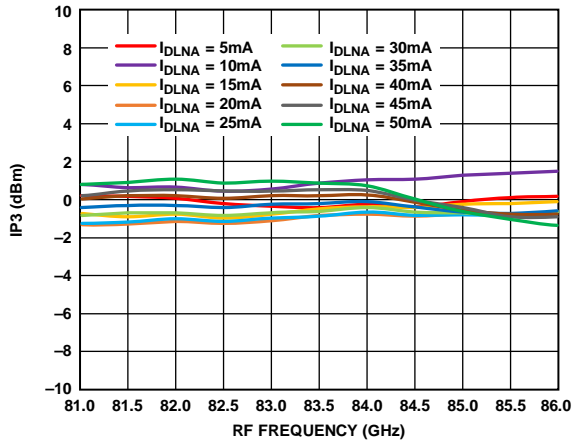

13141-196

Figure 180. Input IP3 vs. RF Frequency at Various I_{DLNA} Values, $R_{FIN} = -20$ dBm, $LO = 2$ dBm, $IF = 2000$ MHz, $V_{DLNA} = 4$ V

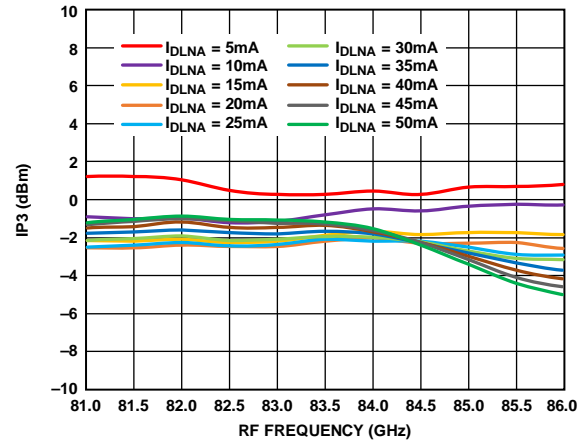

13141-199

Figure 183. Input IP3 vs. RF Frequency at Various I_{DLNA} Values, $R_{FIN} = -20$ dBm, $LO = 2$ dBm, $IF = 2000$ MHz, $V_{DLNA} = 3$ V

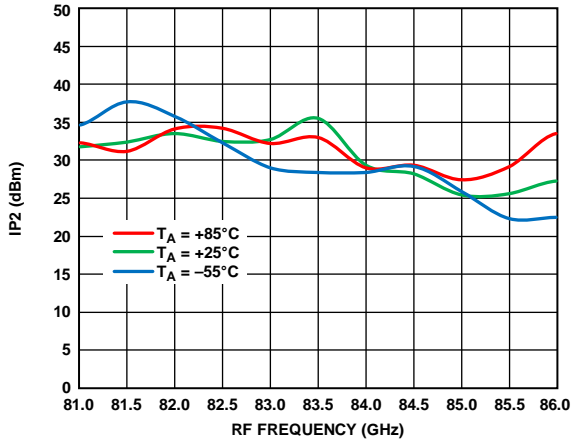

Figure 184. Input IP2 vs. RF Frequency at Various Temperatures, $RFIN = -20\text{ dBm}$, $LO = 2\text{ dBm}$, $IF = 2000\text{ MHz}$, $V_{DLNA} = 4\text{ V}$

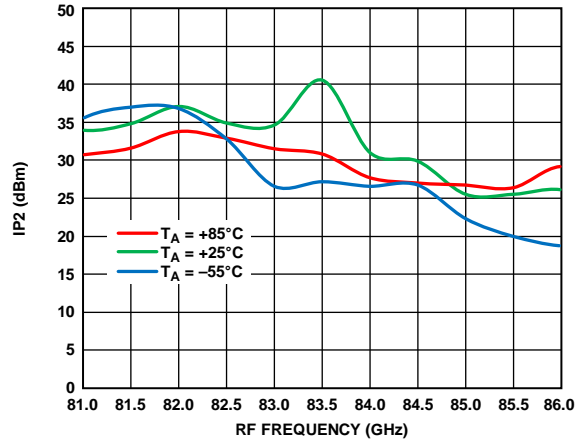

Figure 187. Input IP2 vs. RF Frequency at Various Temperatures, $RFIN = -20\text{ dBm}$, $LO = 2\text{ dBm}$, $IF = 2000\text{ MHz}$, $V_{DLNA} = 3\text{ V}$

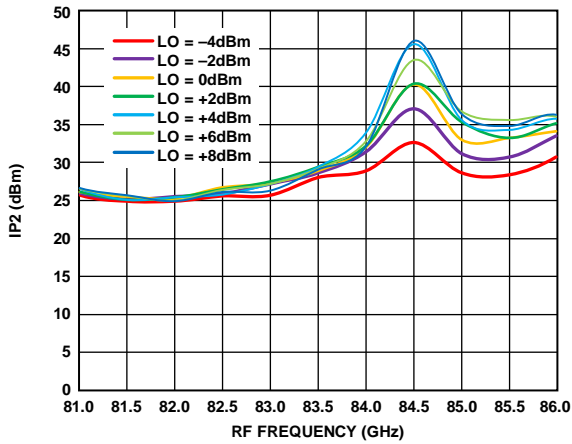

Figure 185. Input IP2 vs. RF Frequency at Various LO Powers, $RFIN = -20\text{ dBm}$, $IF = 2000\text{ MHz}$, $V_{DLNA} = 4\text{ V}$

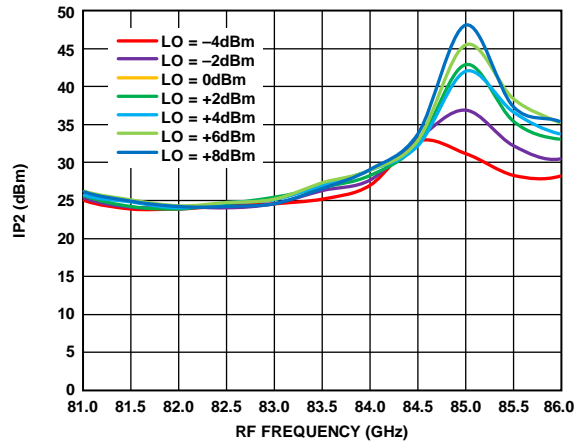

Figure 188. Input IP2 vs. RF Frequency at Various LO Powers, $RFIN = -20\text{ dBm}$, $IF = 2000\text{ MHz}$, $V_{DLNA} = 3\text{ V}$

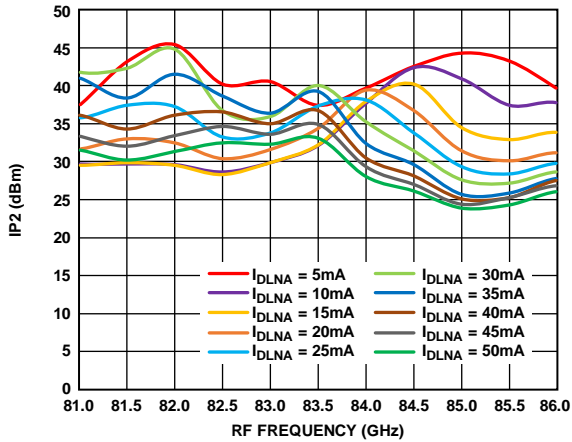

Figure 186. Input IP2 vs. RF Frequency at Various I_{DLNA} Values, $RFIN = -20\text{ dBm}$, $LO = 2\text{ dBm}$, $IF = 2000\text{ MHz}$, $V_{DLNA} = 4\text{ V}$

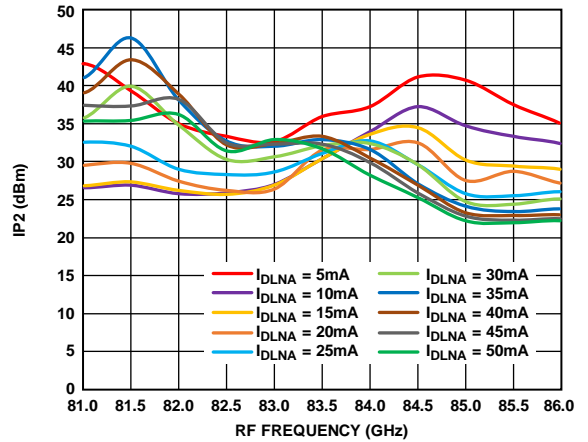

Figure 189. Input IP2 vs. RF Frequency at Various I_{DLNA} Values, $RFIN = -20\text{ dBm}$, $LO = 2\text{ dBm}$, $IF = 2000\text{ MHz}$, $V_{DLNA} = 3\text{ V}$

13141-200

13141-203

13141-201

13141-204

13141-202

13141-205

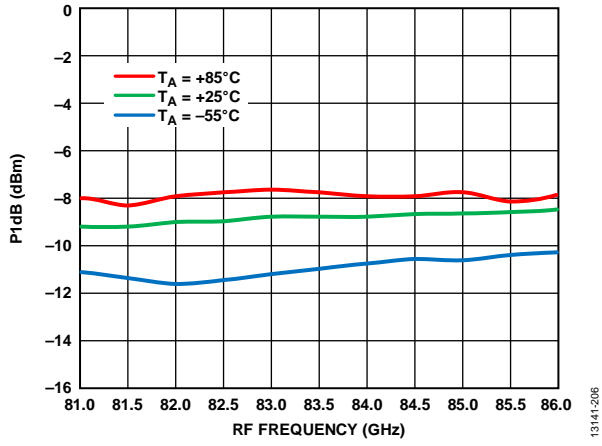

Figure 190. Input P1dB vs. RF Frequency at Various Temperatures, LO = 2 dBm, IF = 2000 MHz, V_{DLNA} = 4 V

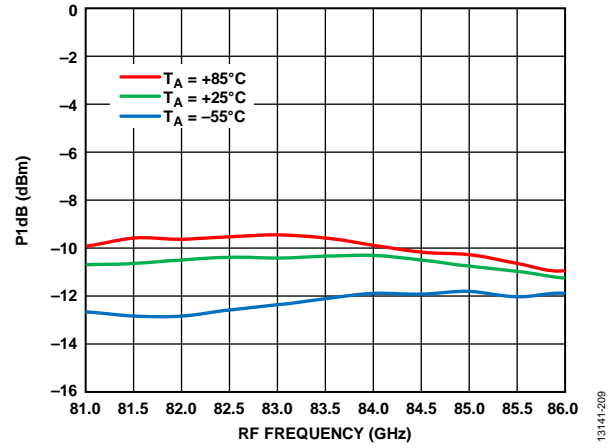

Figure 191. Input P1dB vs. RF Frequency at Various Temperatures, LO = 2 dBm, IF = 2000 MHz, V_{DLNA} = 3 V

NOISE FIGURE PERFORMANCE WITH LOWER SIDEBAND SELECTED

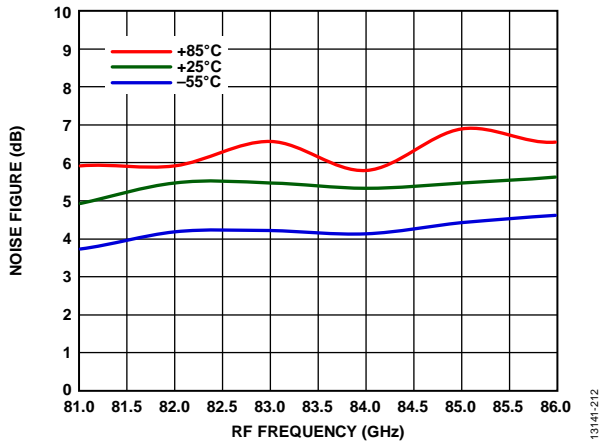

Figure 192. Noise Figure vs. RF Frequency at Various Temperatures, LO = 2 dBm, IF = 500 MHz, V_{DLNA} = 3 V

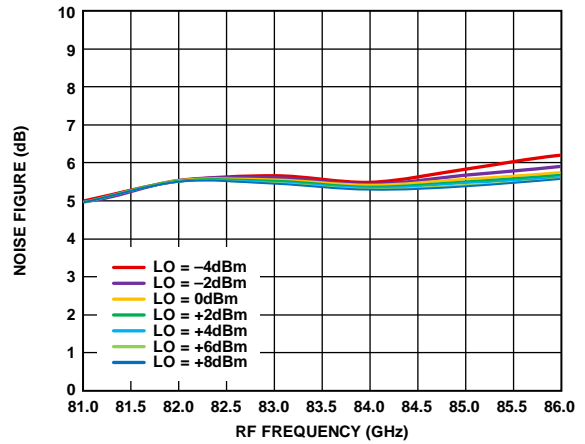

Figure 195. Noise Figure vs. RF Frequency at Various LO Powers, IF = 500 MHz, V_{DLNA} = 3 V

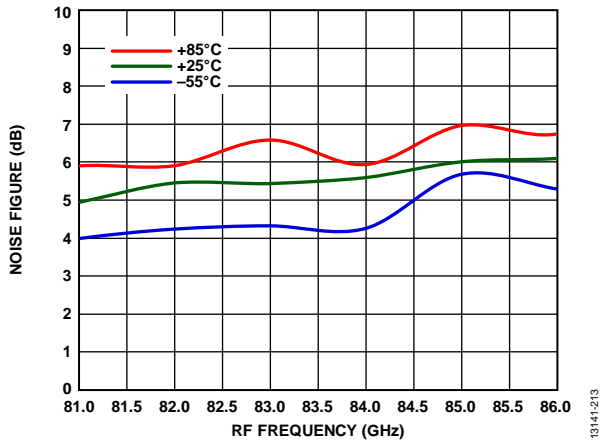

Figure 193. Noise Figure vs. RF Frequency at Various Temperatures, LO = 2 dBm, IF = 1000 MHz, V_{DLNA} = 3 V

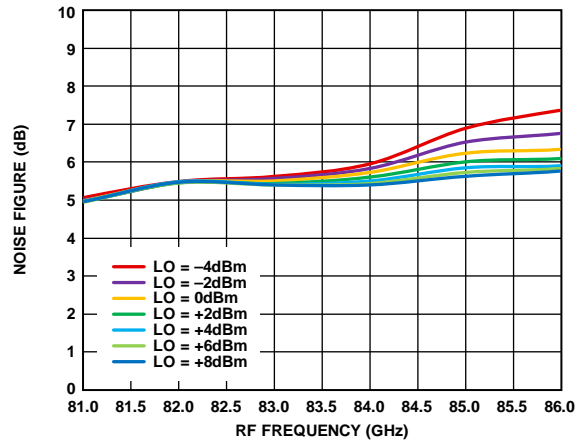

Figure 196. Noise Figure vs. RF Frequency at Various LO Powers, RFIN = -20 dBm, IF = 500 MHz, V_{DLNA} = 3 V

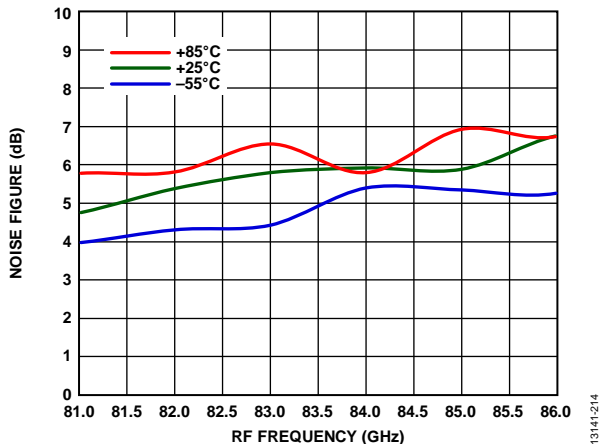

Figure 194. Noise Figure vs. RF Frequency at Various Temperatures, LO = 2 dBm, IF = 2000 MHz, V_{DLNA} = 3 V

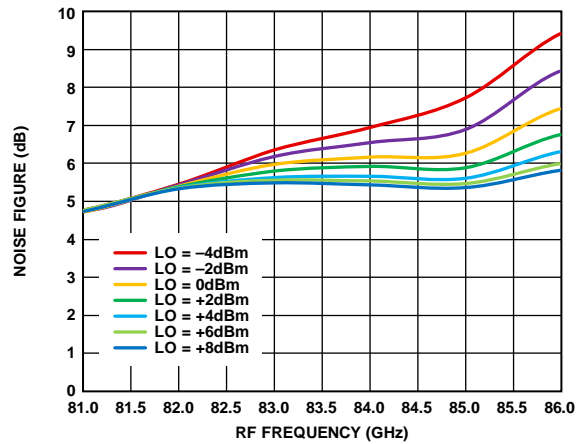

Figure 197. Noise Figure vs. RF Frequency at Various LO Powers, IF = 2000 MHz, V_{DLNA} = 3 V

AMPLITUDE BALANCE PERFORMANCE WITH LOWER SIDEBAND SELECTED

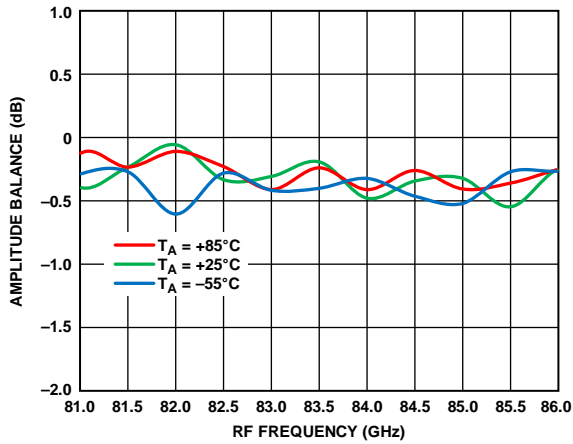

Figure 198. Amplitude Balance vs. RF Frequency at Various Temperatures, RFIN = -20 dBm, LO = 2 dBm, IF = 500 MHz, VDLNA = 4 V

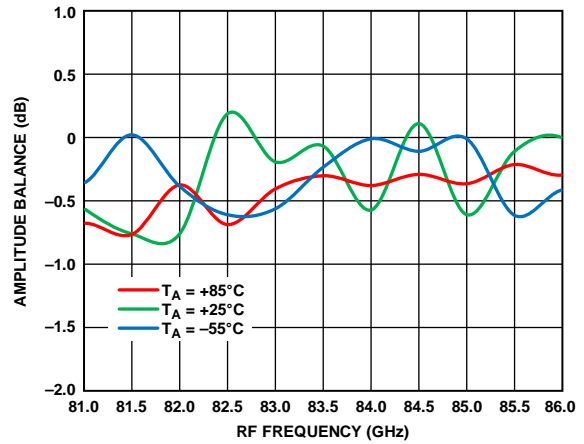

Figure 201. Amplitude Balance vs. RF Frequency at Various Temperatures, RFIN = -20 dBm, LO = 2 dBm, IF = 500 MHz, VDLNA = 3 V

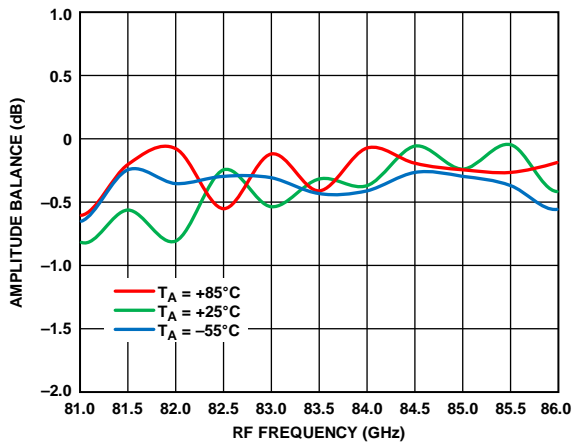

Figure 199. Amplitude Balance vs. RF Frequency at Various Temperatures, RFIN = -20 dBm, LO = 2 dBm, IF = 1000 MHz, VDLNA = 4 V

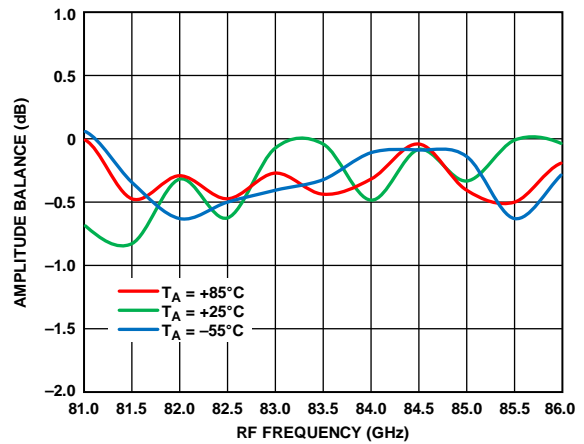

Figure 202. Amplitude Balance vs. RF Frequency at Various Temperatures, RFIN = -20 dBm, LO = 2 dBm, IF = 1000 MHz, VDLNA = 3 V

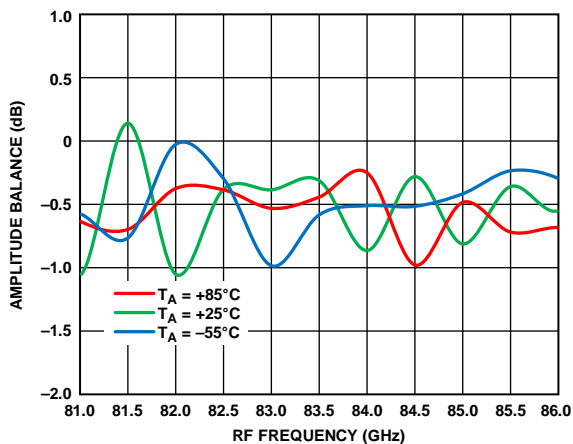

Figure 200. Amplitude Balance vs. RF Frequency at Various Temperatures, RFIN = -20 dBm, LO = 2 dBm, IF = 2000 MHz, VDLNA = 4 V

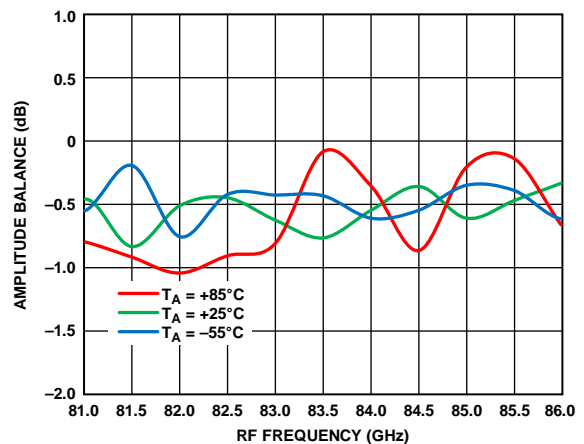

Figure 203. Amplitude Balance vs. RF Frequency at Various Temperatures, RFIN = -20 dBm, LO = 2 dBm, IF = 2000 MHz, VDLNA = 3 V

PHASE BALANCE PERFORMANCE WITH LOWER SIDEBAND SELECTED

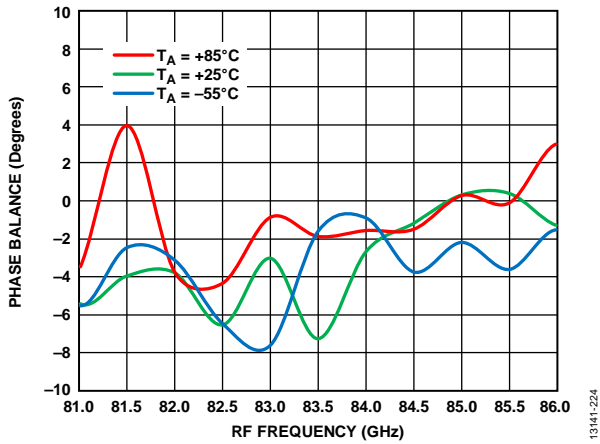

Figure 204. Phase Balance vs. RF Frequency at Various Temperatures, RFIN = -20 dBm, LO = 2 dBm, IF = 500 MHz, VDLNA = 4 V

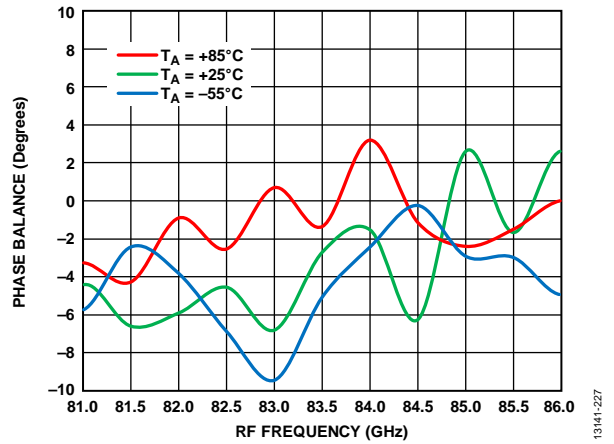

Figure 207. Phase Balance vs. RF Frequency at Various Temperatures, RFIN = -20 dBm, LO = 2 dBm, IF = 500 MHz, VDLNA = 3 V

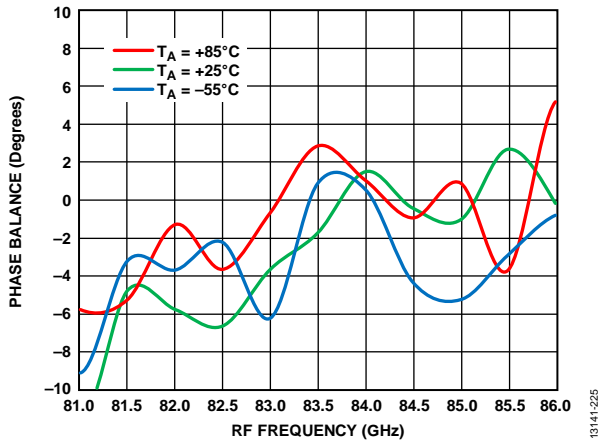

Figure 205. Phase Balance vs. RF Frequency at Various Temperatures, RFIN = -20 dBm, LO = 2 dBm, IF = 1000 MHz, VDLNA = 4 V

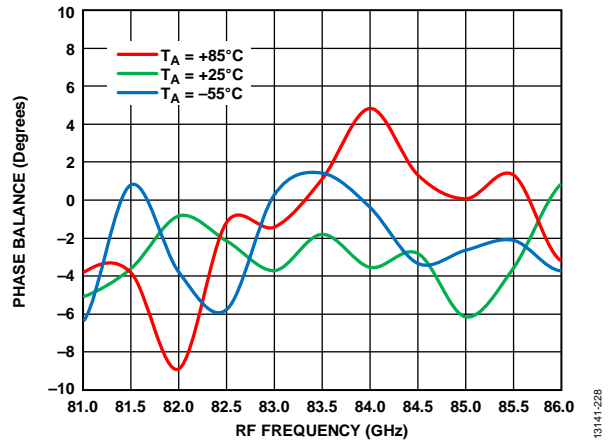

Figure 208. Phase Balance vs. RF Frequency at Various Temperatures, RFIN = -20 dBm, LO = 2 dBm, IF = 1000 MHz, VDLNA = 3 V

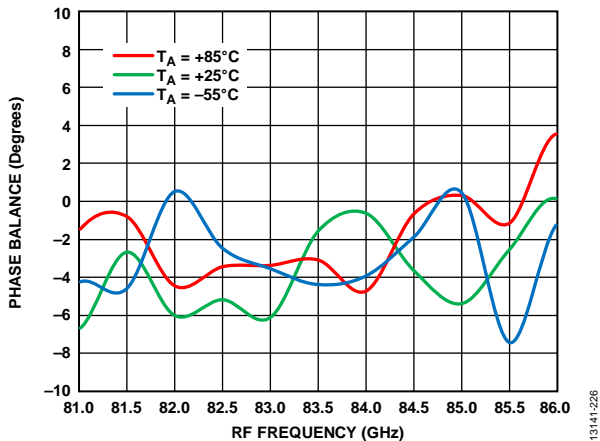

Figure 206. Phase Balance vs. RF Frequency at Various Temperatures, RFIN = -20 dBm, LO = 2 dBm, IF = 2000 MHz, VDLNA = 4 V

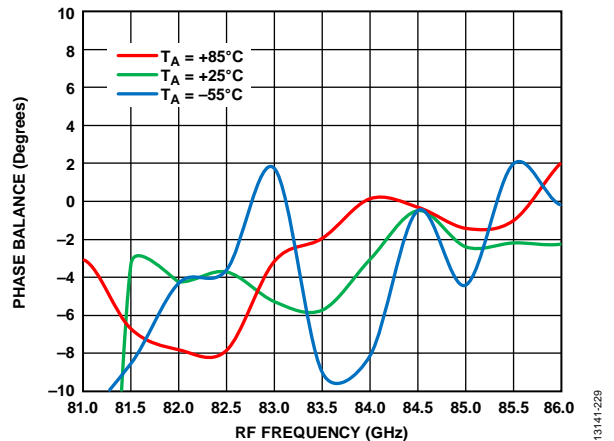

Figure 209. Phase Balance vs. RF Frequency at Various Temperatures, RFIN = -20 dBm, LO = 2 dBm, IF = 2000 MHz, VDLNA = 3 V

SPURIOUS PERFORMANCE WITH UPPER SIDEBAND SELECTED, IF = 500 MHz

$T_A = 25^\circ\text{C}$, $V_{\text{GMIX}} = -1\text{ V}$, $V_{\text{DAMPx}} = 4\text{ V}$, $V_{\text{DMULT}} = 1.5\text{ V}$,
 $\text{LOIN} = 2\text{ dBm}$.

Mixer spurious products are measured in dBc from the IF output power level. Spur values are $(M \times \text{RF}) - (N \times \text{LO})$. N/A means not applicable.

$M \times N$ Spurious Outputs, $V_{\text{DLNA}} = 4\text{ V}$

RF = 81 GHz at $\text{RFIN} = -10\text{ dBm}$, LO frequency = 13.416 GHz at $\text{LOIN} = 2\text{ dBm}$.

		N × LO						
		0	1	2	3	4	5	6
M × RF	0	N/A	N/A	N/A	N/A	N/A	N/A	N/A
	1	N/A	N/A	N/A	N/A	N/A	N/A	N/A
	2	N/A	N/A	29.2	N/A	N/A	N/A	N/A
	3	N/A	N/A	N/A	39	N/A	N/A	N/A
	4	N/A	N/A	N/A	N/A	57	N/A	N/A
	5	N/A	N/A	N/A	N/A	N/A	59.7	N/A

RF = 83 GHz at $\text{RFIN} = -10\text{ dBm}$, LO frequency = 13.75 GHz at $\text{LOIN} = 2\text{ dBm}$.

		N × LO						
		0	1	2	3	4	5	6
M × RF	0	N/A	N/A	N/A	N/A	N/A	N/A	N/A
	1	N/A	N/A	N/A	N/A	N/A	N/A	N/A
	2	N/A	N/A	25	N/A	N/A	N/A	N/A
	3	N/A	N/A	N/A	36.6	N/A	N/A	N/A
	4	N/A	N/A	N/A	N/A	49.3	N/A	N/A
	5	N/A	N/A	N/A	N/A	N/A	53.9	N/A

RF = 86 GHz at $\text{RFIN} = -10\text{ dBm}$, LO frequency = 14.25 GHz at $\text{LOIN} = 2\text{ dBm}$.

		N × LO						
		0	1	2	3	4	5	6
M × RF	0	N/A	N/A	N/A	N/A	N/A	N/A	N/A
	1	N/A	N/A	N/A	N/A	N/A	N/A	N/A
	2	N/A	N/A	29.6	N/A	N/A	N/A	N/A
	3	N/A	N/A	N/A	43.1	N/A	N/A	N/A
	4	N/A	N/A	N/A	N/A	61.2	N/A	N/A
	5	N/A	N/A	N/A	N/A	N/A	63.5	N/A

$M \times N$ Spurious Outputs, $V_{\text{DLNA}} = 3\text{ V}$

RF = 81 GHz at $\text{RFIN} = -10\text{ dBm}$, LO frequency = 13.416 GHz at $\text{LOIN} = 2\text{ dBm}$.

		N × LO						
		0	1	2	3	4	5	6
M × RF	0	N/A	N/A	N/A	N/A	N/A	N/A	N/A
	1	N/A	N/A	N/A	N/A	N/A	N/A	N/A
	2	N/A	N/A	30.3	N/A	N/A	N/A	N/A
	3	N/A	N/A	N/A	41.5	N/A	N/A	N/A
	4	N/A	N/A	N/A	N/A	59.4	N/A	N/A
	5	N/A	N/A	N/A	N/A	N/A	64	N/A

RF = 83 GHz at $\text{RFIN} = -10\text{ dBm}$, LO frequency = 13.75 MHz at $\text{LOIN} = 2\text{ dBm}$.

		N × LO						
		0	1	2	3	4	5	6
M × RF	0	N/A	N/A	N/A	N/A	N/A	N/A	N/A
	1	N/A	N/A	N/A	N/A	N/A	N/A	N/A
	2	N/A	N/A	26	N/A	N/A	N/A	N/A
	3	N/A	N/A	N/A	38.7	N/A	N/A	N/A
	4	N/A	N/A	N/A	N/A	52.1	N/A	N/A
	5	N/A	N/A	N/A	N/A	N/A	57.2	N/A

RF = 86 GHz at $\text{RFIN} = -10\text{ dBm}$, LO frequency = 14.25 GHz at $\text{LOIN} = 2\text{ dBm}$.

		N × LO						
		0	1	2	3	4	5	6
M × RF	0	N/A	N/A	N/A	N/A	N/A	N/A	N/A
	1	N/A	N/A	N/A	N/A	N/A	N/A	N/A
	2	N/A	N/A	30.1	N/A	N/A	N/A	N/A
	3	N/A	N/A	N/A	45.4	N/A	N/A	N/A
	4	N/A	N/A	N/A	N/A	62.9	N/A	N/A
	5	N/A	N/A	N/A	N/A	N/A	67.3	N/A

SPURIOUS PERFORMANCE WITH UPPER SIDEBAND SELECTED, IF = 1000 MHz

$T_A = 25^\circ\text{C}$, $V_{\text{GMIX}} = -1\text{ V}$, $V_{\text{DAMPx}} = 4\text{ V}$, $V_{\text{DMULT}} = 1.5\text{ V}$, $\text{LOIN} = 2\text{ dBm}$.

Mixer spurious products are measured in dBc from the IF output power level. Spur values are $(M \times \text{RF}) - (N \times \text{LO})$. N/A means not applicable.

$M \times N$ Spurious Outputs, $V_{\text{DLNA}} = 4\text{ V}$

RF = 81 GHz at $\text{RFIN} = -10\text{ dBm}$, LO frequency = 13.333 GHz at $\text{LOIN} = 2\text{ dBm}$.

		N × LO						
		0	1	2	3	4	5	6
M × RF	0	N/A	N/A	N/A	N/A	N/A	N/A	N/A
	1	N/A	N/A	N/A	N/A	N/A	N/A	N/A
	2	N/A	N/A	28.4	N/A	N/A	N/A	N/A
	3	N/A	N/A	N/A	38.9	N/A	N/A	N/A
	4	N/A	N/A	N/A	N/A	56.5	N/A	N/A
	5	N/A	N/A	N/A	N/A	N/A	59.3	N/A

RF = 83 GHz at $\text{RFIN} = -10\text{ dBm}$, LO frequency = 13.666 MHz at $\text{LOIN} = 2\text{ dBm}$.

		N × LO						
		0	1	2	3	4	5	6
M × RF	0	N/A	N/A	N/A	N/A	N/A	N/A	N/A
	1	N/A	N/A	N/A	N/A	N/A	N/A	N/A
	2	N/A	N/A	26.5	N/A	N/A	N/A	N/A
	3	N/A	N/A	N/A	37.1	N/A	N/A	N/A
	4	N/A	N/A	N/A	N/A	52.8	N/A	N/A
	5	N/A	N/A	N/A	N/A	N/A	56.7	N/A

RF = 86 GHz at $\text{RFIN} = -10\text{ dBm}$, LO frequency = 14.166 GHz at $\text{LOIN} = 2\text{ dBm}$.

		N × LO						
		0	1	2	3	4	5	6
M × RF	0	N/A	N/A	N/A	N/A	N/A	N/A	N/A
	1	N/A	N/A	N/A	N/A	N/A	N/A	N/A
	2	N/A	N/A	27.9	N/A	N/A	N/A	N/A
	3	N/A	N/A	N/A	42	N/A	N/A	N/A
	4	N/A	N/A	N/A	N/A	60.2	N/A	N/A
	5	N/A	N/A	N/A	N/A	N/A	62.7	N/A

$M \times N$ Spurious Outputs, $V_{\text{DLNA}} = 3\text{ V}$

RF = 81 GHz at $\text{RFIN} = -10\text{ dBm}$, LO frequency = 13.333 GHz at $\text{LOIN} = 2\text{ dBm}$.

		N × LO						
		0	1	2	3	4	5	6
M × RF	0	N/A	N/A	N/A	N/A	N/A	N/A	N/A
	1	N/A	N/A	N/A	N/A	N/A	N/A	N/A
	2	N/A	N/A	29.7	N/A	N/A	N/A	N/A
	3	N/A	N/A	N/A	41.7	N/A	N/A	N/A
	4	N/A	N/A	N/A	N/A	58.7	N/A	N/A
	5	N/A	N/A	N/A	N/A	N/A	63.4	N/A

RF = 83 GHz at $\text{RFIN} = -10\text{ dBm}$, LO frequency = 13.666 MHz at $\text{LOIN} = 2\text{ dBm}$.

		N × LO						
		0	1	2	3	4	5	6
M × RF	0	N/A	N/A	N/A	N/A	N/A	N/A	N/A
	1	N/A	N/A	N/A	N/A	N/A	N/A	N/A
	2	N/A	N/A	27.5	N/A	N/A	N/A	N/A
	3	N/A	N/A	N/A	39.3	N/A	N/A	N/A
	4	N/A	N/A	N/A	N/A	55.1	N/A	N/A
	5	N/A	N/A	N/A	N/A	N/A	60.4	N/A

RF = 86 GHz at $\text{RFIN} = -10\text{ dBm}$, LO frequency = 14.166 GHz at $\text{LOIN} = 2\text{ dBm}$.

		N × LO						
		0	1	2	3	4	5	6
M × RF	0	N/A	N/A	N/A	N/A	N/A	N/A	N/A
	1	N/A	N/A	N/A	N/A	N/A	N/A	N/A
	2	N/A	N/A	28.8	N/A	N/A	N/A	N/A
	3	N/A	N/A	N/A	44.2	N/A	N/A	N/A
	4	N/A	N/A	N/A	N/A	62.1	N/A	N/A
	5	N/A	N/A	N/A	N/A	N/A	66.6	N/A

SPURIOUS PERFORMANCE WITH UPPER SIDEBAND SELECTED, IF = 2000 MHz

$T_A = 25^\circ\text{C}$, $V_{\text{GMIX}} = -1\text{ V}$, $V_{\text{DAMPx}} = 4\text{ V}$, $V_{\text{DMULT}} = 1.5\text{ V}$, LOIN = 2 dBm.

Mixer spurious products are measured in dBc from the IF output power level. Spur values are $(M \times \text{RF}) - (N \times \text{LO})$. N/A means not applicable.

$M \times N$ Spurious Outputs, $V_{\text{DLNA}} = 4\text{ V}$

RF = 81 GHz at RFIN = -10 dBm, LO frequency = 13.166 GHz at LOIN = 2 dBm.

		N × LO						
		0	1	2	3	4	5	6
M × RF	0	N/A	N/A	N/A	N/A	N/A	N/A	N/A
	1	N/A	N/A	N/A	N/A	N/A	N/A	N/A
	2	N/A	N/A	28.1	N/A	N/A	N/A	N/A
	3	N/A	N/A	N/A	42	N/A	N/A	N/A
	4	N/A	N/A	N/A	N/A	56.3	N/A	N/A
	5	N/A	N/A	N/A	N/A	N/A	61.1	N/A

RF = 83 GHz at RFIN = -10 dBm, LO frequency = 13.5 MHz at LOIN = 2 dBm.

		N × LO						
		0	1	2	3	4	5	6
M × RF	0	N/A	N/A	N/A	N/A	N/A	N/A	N/A
	1	N/A	N/A	N/A	N/A	N/A	N/A	N/A
	2	N/A	N/A	27.8	N/A	N/A	N/A	N/A
	3	N/A	N/A	N/A	38.5	N/A	N/A	N/A
	4	N/A	N/A	N/A	N/A	55.6	N/A	N/A
	5	N/A	N/A	N/A	N/A	N/A	60.8	N/A

RF = 86 GHz at RFIN = -10 dBm, LO frequency = 14 GHz at LOIN = 2 dBm

		N × LO						
		0	1	2	3	4	5	6
M × RF	0	N/A	N/A	N/A	N/A	N/A	N/A	N/A
	1	N/A	N/A	N/A	N/A	N/A	N/A	N/A
	2	N/A	N/A	25.1	N/A	N/A	N/A	N/A
	3	N/A	N/A	N/A	38.5	N/A	N/A	N/A
	4	N/A	N/A	N/A	N/A	52.9	N/A	N/A
	5	N/A	N/A	N/A	N/A	N/A	52.3	N/A

$M \times N$ Spurious Outputs, $V_{\text{DLNA}} = 3\text{ V}$

RF = 81 GHz at RFIN = -10 dBm, LO frequency = 13.166 GHz at LOIN = 2 dBm.

		N × LO						
		0	1	2	3	4	5	6
M × RF	0	N/A	N/A	N/A	N/A	N/A	N/A	N/A
	1	N/A	N/A	N/A	N/A	N/A	N/A	N/A
	2	N/A	N/A	29.6	N/A	N/A	N/A	N/A
	3	N/A	N/A	N/A	45.1	N/A	N/A	N/A
	4	N/A	N/A	N/A	N/A	58.7	N/A	N/A
	5	N/A	N/A	N/A	N/A	N/A	65.5	N/A

RF = 83 GHz at RFIN = -10 dBm, LO frequency = 13.5 MHz at LOIN = 2 dBm.

		N × LO						
		0	1	2	3	4	5	6
M × RF	0	N/A	N/A	N/A	N/A	N/A	N/A	N/A
	1	N/A	N/A	N/A	N/A	N/A	N/A	N/A
	2	N/A	N/A	28.8	N/A	N/A	N/A	N/A
	3	N/A	N/A	N/A	41	N/A	N/A	N/A
	4	N/A	N/A	N/A	N/A	58.6	N/A	N/A
	5	N/A	N/A	N/A	N/A	N/A	64.7	N/A

RF = 86 GHz at RFIN = -10 dBm, LO frequency = 14 GHz at LOIN = 2 dBm

		N × LO						
		0	1	2	3	4	5	6
M × RF	0	N/A	N/A	N/A	N/A	N/A	N/A	N/A
	1	N/A	N/A	N/A	N/A	N/A	N/A	N/A
	2	N/A	N/A	26	N/A	N/A	N/A	N/A
	3	N/A	N/A	N/A	40.7	N/A	N/A	N/A
	4	N/A	N/A	N/A	N/A	56.5	N/A	N/A
	5	N/A	N/A	N/A	N/A	N/A	54.2	N/A

SPURIOUS PERFORMANCE WITH LOWER SIDEBAND SELECTED, IF = 500 MHz

$T_A = 25^\circ\text{C}$, $V_{\text{GMIX}} = -1\text{ V}$, $V_{\text{DAMPx}} = 4\text{ V}$, $V_{\text{DMULT}} = 1.5\text{ V}$, $\text{LOIN} = 2\text{ dBm}$.

Mixer spurious products are measured in dBc from the IF output power level. Spur values are $(M \times \text{RF}) - (N \times \text{LO})$. N/A means not applicable.

$M \times N$ Spurious Outputs, $V_{\text{DLNA}} = 4\text{ V}$

RF = 81 GHz at $\text{RFIN} = -10\text{ dBm}$, LO frequency = 13.583 GHz at $\text{LOIN} = 2\text{ dBm}$.

		N × LO						
		0	1	2	3	4	5	6
M × RF	0	N/A	N/A	N/A	N/A	N/A	N/A	N/A
	1	N/A	N/A	N/A	N/A	N/A	N/A	N/A
	2	N/A	N/A	27.6	N/A	N/A	N/A	N/A
	3	N/A	N/A	N/A	38.5	N/A	N/A	N/A
	4	N/A	N/A	N/A	N/A	52.8	N/A	N/A
	5	N/A	N/A	N/A	N/A	N/A	55.9	N/A

RF = 83 GHz at $\text{RFIN} = -10\text{ dBm}$, LO frequency = 13.916 GHz at $\text{LOIN} = 2\text{ dBm}$.

		N × LO						
		0	1	2	3	4	5	6
M × RF	0	N/A	N/A	N/A	N/A	N/A	N/A	N/A
	1	N/A	N/A	N/A	N/A	N/A	N/A	N/A
	2	N/A	N/A	25.4	N/A	N/A	N/A	N/A
	3	N/A	N/A	N/A	38.3	N/A	N/A	N/A
	4	N/A	N/A	N/A	N/A	49.2	N/A	N/A
	5	N/A	N/A	N/A	N/A	N/A	55.1	N/A

RF = 86 GHz at $\text{RFIN} = -10\text{ dBm}$, LO frequency = 14.416 GHz at $\text{LOIN} = 2\text{ dBm}$.

		N × LO						
		0	1	2	3	4	5	6
M × RF	0	N/A	N/A	N/A	N/A	N/A	N/A	N/A
	1	N/A	N/A	N/A	N/A	N/A	N/A	N/A
	2	N/A	N/A	28.9	N/A	N/A	N/A	N/A
	3	N/A	N/A	N/A	44.8	N/A	N/A	N/A
	4	N/A	N/A	N/A	N/A	59.1	N/A	N/A
	5	N/A	N/A	N/A	N/A	N/A	64.8	N/A

$M \times N$ Spurious Outputs, $V_{\text{DLNA}} = 3\text{ V}$

RF = 81 GHz at $\text{RFIN} = -10\text{ dBm}$, LO frequency = 13.583 GHz at $\text{LOIN} = 2\text{ dBm}$.

		N × LO						
		0	1	2	3	4	5	6
M × RF	0	N/A	N/A	N/A	N/A	N/A	N/A	N/A
	1	N/A	N/A	N/A	N/A	N/A	N/A	N/A
	2	N/A	N/A	28.5	N/A	N/A	N/A	N/A
	3	N/A	N/A	N/A	40.6	N/A	N/A	N/A
	4	N/A	N/A	N/A	N/A	55.6	N/A	N/A
	5	N/A	N/A	N/A	N/A	N/A	59.8	N/A

RF = 83 GHz at $\text{RFIN} = -10\text{ dBm}$, LO frequency = 13.916 MHz at $\text{LOIN} = 2\text{ dBm}$.

		N × LO						
		0	1	2	3	4	5	6
M × RF	0	N/A	N/A	N/A	N/A	N/A	N/A	N/A
	1	N/A	N/A	N/A	N/A	N/A	N/A	N/A
	2	N/A	N/A	26.3	N/A	N/A	N/A	N/A
	3	N/A	N/A	N/A	40	N/A	N/A	N/A
	4	N/A	N/A	N/A	N/A	52.1	N/A	N/A
	5	N/A	N/A	N/A	N/A	N/A	58.3	N/A

RF = 86 GHz at $\text{RFIN} = -10\text{ dBm}$, LO frequency = 14.416 GHz at $\text{LOIN} = 2\text{ dBm}$.

		N × LO						
		0	1	2	3	4	5	6
M × RF	0	N/A	N/A	N/A	N/A	N/A	N/A	N/A
	1	N/A	N/A	N/A	N/A	N/A	N/A	N/A
	2	N/A	N/A	28.8	N/A	N/A	N/A	N/A
	3	N/A	N/A	N/A	46.5	N/A	N/A	N/A
	4	N/A	N/A	N/A	N/A	61.6	N/A	N/A
	5	N/A	N/A	N/A	N/A	N/A	68.5	N/A

SPURIOUS PERFORMANCE WITH LOWER SIDEBAND SELECTED, IF = 1000 MHz

$T_A = 25^\circ\text{C}$, $V_{\text{GMIX}} = -1\text{ V}$, $V_{\text{DAMPx}} = 4\text{ V}$, $V_{\text{DMULT}} = 1.5\text{ V}$, $\text{LOIN} = 2\text{ dBm}$.

Mixer spurious products are measured in dBc from the IF output power level. Spur values are $(M \times \text{RF}) - (N \times \text{LO})$. N/A means not applicable.

$M \times N$ Spurious Outputs, $V_{\text{DLNA}} = 4\text{ V}$

RF = 81 GHz at $\text{RFIN} = -10\text{ dBm}$, LO frequency = 13.666 GHz at $\text{LOIN} = 2\text{ dBm}$.

		N × LO						
		0	1	2	3	4	5	6
M × RF	0	N/A	N/A	N/A	N/A	N/A	N/A	N/A
	1	N/A	N/A	N/A	N/A	N/A	N/A	N/A
	2	N/A	N/A	26.5	N/A	N/A	N/A	N/A
	3	N/A	N/A	N/A	37.1	N/A	N/A	N/A
	4	N/A	N/A	N/A	N/A	51	N/A	N/A
	5	N/A	N/A	N/A	N/A	N/A	55.6	N/A

RF = 83 GHz at $\text{RFIN} = -10\text{ dBm}$, LO frequency = 14 GHz at $\text{LOIN} = 2\text{ dBm}$.

		N × LO						
		0	1	2	3	4	5	6
M × RF	0	N/A	N/A	N/A	N/A	N/A	N/A	N/A
	1	N/A	N/A	N/A	N/A	N/A	N/A	N/A
	2	N/A	N/A	26.5	N/A	N/A	N/A	N/A
	3	N/A	N/A	N/A	40	N/A	N/A	N/A
	4	N/A	N/A	N/A	N/A	50.8	N/A	N/A
	5	N/A	N/A	N/A	N/A	N/A	59.4	N/A

RF = 86 GHz at $\text{RFIN} = -10\text{ dBm}$, LO frequency = 14.5 GHz at $\text{LOIN} = 2\text{ dBm}$.

		N × LO						
		0	1	2	3	4	5	6
M × RF	0	N/A	N/A	N/A	N/A	N/A	N/A	N/A
	1	N/A	N/A	N/A	N/A	N/A	N/A	N/A
	2	N/A	N/A	27.7	N/A	N/A	N/A	N/A
	3	N/A	N/A	N/A	42.8	N/A	N/A	N/A
	4	N/A	N/A	N/A	N/A	56.9	N/A	N/A
	5	N/A	N/A	N/A	N/A	N/A	68.1	N/A

$M \times N$ Spurious Outputs, $V_{\text{DLNA}} = 3\text{ V}$

RF = 81 GHz at $\text{RFIN} = -10\text{ dBm}$, LO frequency = 13.666 GHz at $\text{LOIN} = 2\text{ dBm}$.

		N × LO						
		0	1	2	3	4	5	6
M × RF	0	N/A	N/A	N/A	N/A	N/A	N/A	N/A
	1	N/A	N/A	N/A	N/A	N/A	N/A	N/A
	2	N/A	N/A	27.6	N/A	N/A	N/A	N/A
	3	N/A	N/A	N/A	39.2	N/A	N/A	N/A
	4	N/A	N/A	N/A	N/A	53.4	N/A	N/A
	5	N/A	N/A	N/A	N/A	N/A	59.1	N/A

RF = 83 GHz at $\text{RFIN} = -10\text{ dBm}$, LO frequency = 14 GHz at $\text{LOIN} = 2\text{ dBm}$.

		N × LO						
		0	1	2	3	4	5	6
M × RF	0	N/A	N/A	N/A	N/A	N/A	N/A	N/A
	1	N/A	N/A	N/A	N/A	N/A	N/A	N/A
	2	N/A	N/A	27.4	N/A	N/A	N/A	N/A
	3	N/A	N/A	N/A	41.8	N/A	N/A	N/A
	4	N/A	N/A	N/A	N/A	54.9	N/A	N/A
	5	N/A	N/A	N/A	N/A	N/A	62.9	N/A

RF = 86 GHz at $\text{RFIN} = -10\text{ dBm}$, LO frequency = 14.5 GHz at $\text{LOIN} = 2\text{ dBm}$.

		N × LO						
		0	1	2	3	4	5	6
M × RF	0	N/A	N/A	N/A	N/A	N/A	N/A	N/A
	1	N/A	N/A	N/A	N/A	N/A	N/A	N/A
	2	N/A	N/A	28.1	N/A	N/A	N/A	N/A
	3	N/A	N/A	N/A	45.2	N/A	N/A	N/A
	4	N/A	N/A	N/A	N/A	60.3	N/A	N/A
	5	N/A	N/A	N/A	N/A	N/A	73.2	N/A

SPURIOUS PERFORMANCE WITH LOWER SIDEBAND SELECTED, IF = 2000 MHz

$T_A = 25^\circ\text{C}$, $V_{\text{GMIX}} = -1\text{ V}$, $V_{\text{DAMPx}} = 4\text{ V}$, $V_{\text{DMULT}} = 1.5\text{ V}$, $\text{LOIN} = 2\text{ dBm}$.

Mixer spurious products are measured in dBc from the IF output power level. Spur values are $(M \times \text{RF}) - (N \times \text{LO})$. N/A means not applicable.

$M \times N$ Spurious Outputs, $V_{\text{DLNA}} = 4\text{ V}$

RF = 81 GHz at $\text{RFIN} = -10\text{ dBm}$, LO frequency = 13.833 GHz at $\text{LOIN} = 2\text{ dBm}$.

		N x LO						
		0	1	2	3	4	5	6
M x RF	0	N/A	N/A	N/A	N/A	N/A	N/A	N/A
	1	N/A	N/A	N/A	N/A	N/A	N/A	N/A
	2	N/A	N/A	25.1	N/A	N/A	N/A	N/A
	3	N/A	N/A	N/A	38.3	N/A	N/A	N/A
	4	N/A	N/A	N/A	N/A	48	N/A	N/A
	5	N/A	N/A	N/A	N/A	N/A	56.5	N/A

RF = 83 GHz at $\text{RFIN} = -10\text{ dBm}$, LO frequency = 14.166 GHz at $\text{LOIN} = 2\text{ dBm}$.

		N x LO						
		0	1	2	3	4	5	6
M x RF	0	N/A	N/A	N/A	N/A	N/A	N/A	N/A
	1	N/A	N/A	N/A	N/A	N/A	N/A	N/A
	2	N/A	N/A	27.9	N/A	N/A	N/A	N/A
	3	N/A	N/A	N/A	43.2	N/A	N/A	N/A
	4	N/A	N/A	N/A	N/A	56.2	N/A	N/A
	5	N/A	N/A	N/A	N/A	N/A	65.4	N/A

RF = 86 GHz at $\text{RFIN} = -10\text{ dBm}$, LO frequency = 14.666 GHz at $\text{LOIN} = 2\text{ dBm}$.

		N x LO						
		0	1	2	3	4	5	6
M x RF	0	N/A	N/A	N/A	N/A	N/A	N/A	N/A
	1	N/A	N/A	N/A	N/A	N/A	N/A	N/A
	2	N/A	N/A	22.3	N/A	N/A	N/A	N/A
	3	N/A	N/A	N/A	40.1	N/A	N/A	N/A
	4	N/A	N/A	N/A	N/A	48.1	N/A	N/A
	5	N/A	N/A	N/A	N/A	N/A	63	N/A

$M \times N$ Spurious Outputs, $V_{\text{DLNA}} = 3\text{ V}$

RF = 81 GHz at $\text{RFIN} = -10\text{ dBm}$, LO frequency = 13.833 GHz at $\text{LOIN} = 2\text{ dBm}$.

		N x LO						
		0	1	2	3	4	5	6
M x RF	0	N/A	N/A	N/A	N/A	N/A	N/A	N/A
	1	N/A	N/A	N/A	N/A	N/A	N/A	N/A
	2	N/A	N/A	25.9	N/A	N/A	N/A	N/A
	3	N/A	N/A	N/A	39.5	N/A	N/A	N/A
	4	N/A	N/A	N/A	N/A	51.8	N/A	N/A
	5	N/A	N/A	N/A	N/A	N/A	59.5	N/A

RF = 83 GHz at $\text{RFIN} = -10\text{ dBm}$, LO frequency = 14.166 GHz at $\text{LOIN} = 2\text{ dBm}$.

		N x LO						
		0	1	2	3	4	5	6
M x RF	0	N/A	N/A	N/A	N/A	N/A	N/A	N/A
	1	N/A	N/A	N/A	N/A	N/A	N/A	N/A
	2	N/A	N/A	28.9	N/A	N/A	N/A	N/A
	3	N/A	N/A	N/A	45.6	N/A	N/A	N/A
	4	N/A	N/A	N/A	N/A	60	N/A	N/A
	5	N/A	N/A	N/A	N/A	N/A	63.9	N/A

RF = 86 GHz at $\text{RFIN} = -10\text{ dBm}$, LO frequency = 14.666 GHz at $\text{LOIN} = 2\text{ dBm}$.

		N x LO						
		0	1	2	3	4	5	6
M x RF	0	N/A	N/A	N/A	N/A	N/A	N/A	N/A
	1	N/A	N/A	N/A	N/A	N/A	N/A	N/A
	2	N/A	N/A	23.2	N/A	N/A	N/A	N/A
	3	N/A	N/A	N/A	42.3	N/A	N/A	N/A
	4	N/A	N/A	N/A	N/A	51	N/A	N/A
	5	N/A	N/A	N/A	N/A	N/A	67	N/A

THEORY OF OPERATION

The HMC7587 is a GaAs low noise I/Q downconverter with an integrated LO buffer and a 6x multiplier. See Figure 210 for a functional block diagram of the downconverter circuit architecture.

The RF input is internally ac-coupled and matched to 50 Ω. The input passes through four stages of low noise amplification. The preamplified RF input signal then splits and drives two singly balanced passive mixers.

Quadrature LO signals drive the two I and Q mixer cores. The LO path provides a 6x multiplier that allows the use of a lower frequency range LO input signal, typically between 11.83 GHz and 14.33 GHz. The 6x multiplier is implemented using a cascade of 3x and 2x multipliers. The LO buffer amplifiers are included on-chip to allow a typical LO drive level of only 2 dBm for full performance.

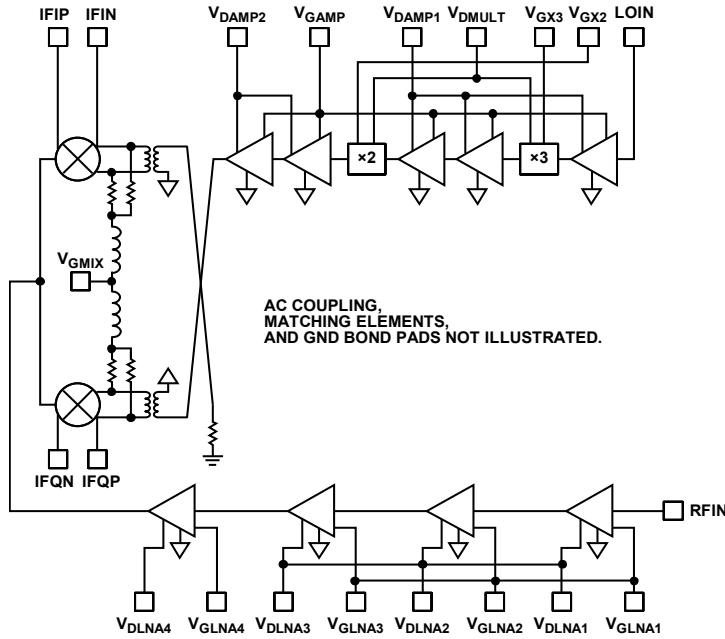

Figure 210. Downconverter Circuit Architecture

13141-230

APPLICATIONS INFORMATION

BIASING SEQUENCE

The HMC7587 uses several amplifier and multiplier stages. The active stages all use depletion mode pseudomorphic high electron mobility transistors (pHEMTs). To ensure transistor damage does not occur, use the following power-up bias sequence:

1. Apply a -2 V bias to V_{GAMP} , V_{GLNA1} , V_{GLNA2} , V_{GLNA3} , V_{GLNA4} , V_{GX2} , and V_{GX3} .
2. Apply a -1 V bias to V_{GMIX} .
3. Apply 4 V to V_{DAMP1} , V_{DAMP2} , V_{DLNA1} , V_{DLNA2} , V_{DLNA3} , and V_{DLNA4} , and apply 1.5 V to V_{DMULT} .
4. Adjust V_{GAMP} between -2 V and 0 V to achieve a total amplifier drain current ($I_{DAMP1} + I_{DAMP2}$) of 175 mA .
5. Adjust V_{GLNA1} , V_{GLNA2} , V_{GLNA3} , and V_{GLNA4} to achieve a total LNA drain current ($I_{DLNA1} + I_{DLNA2} + I_{DLNA3} + I_{DLNA4}$) of 50 mA .
6. Apply the LO input signal with a power level of 2 dBm and adjust V_{GX2} and V_{GX3} between -2 V and 0 V to achieve 80 mA of drain current on V_{DMULT} .

To power down the HMC7587, follow the procedure in reverse.

For additional guidance on general bias sequencing, see the [MMIC Amplifier Biasing Procedure](#) application note.

IMAGE REJECTION DOWNCONVERSION

A typical image rejection downconversion application circuit is shown in Figure 211. For image rejection downconversions, external 180° and 90° hybrid couplers are typically used. The 180° hybrids or baluns convert the differential I and Q output signals to unbalanced waveforms. The 90° hybrid then combines the outputs in quadrature to form a classic Hartley image rejection receiver with a typical image rejection of 30 dBc .

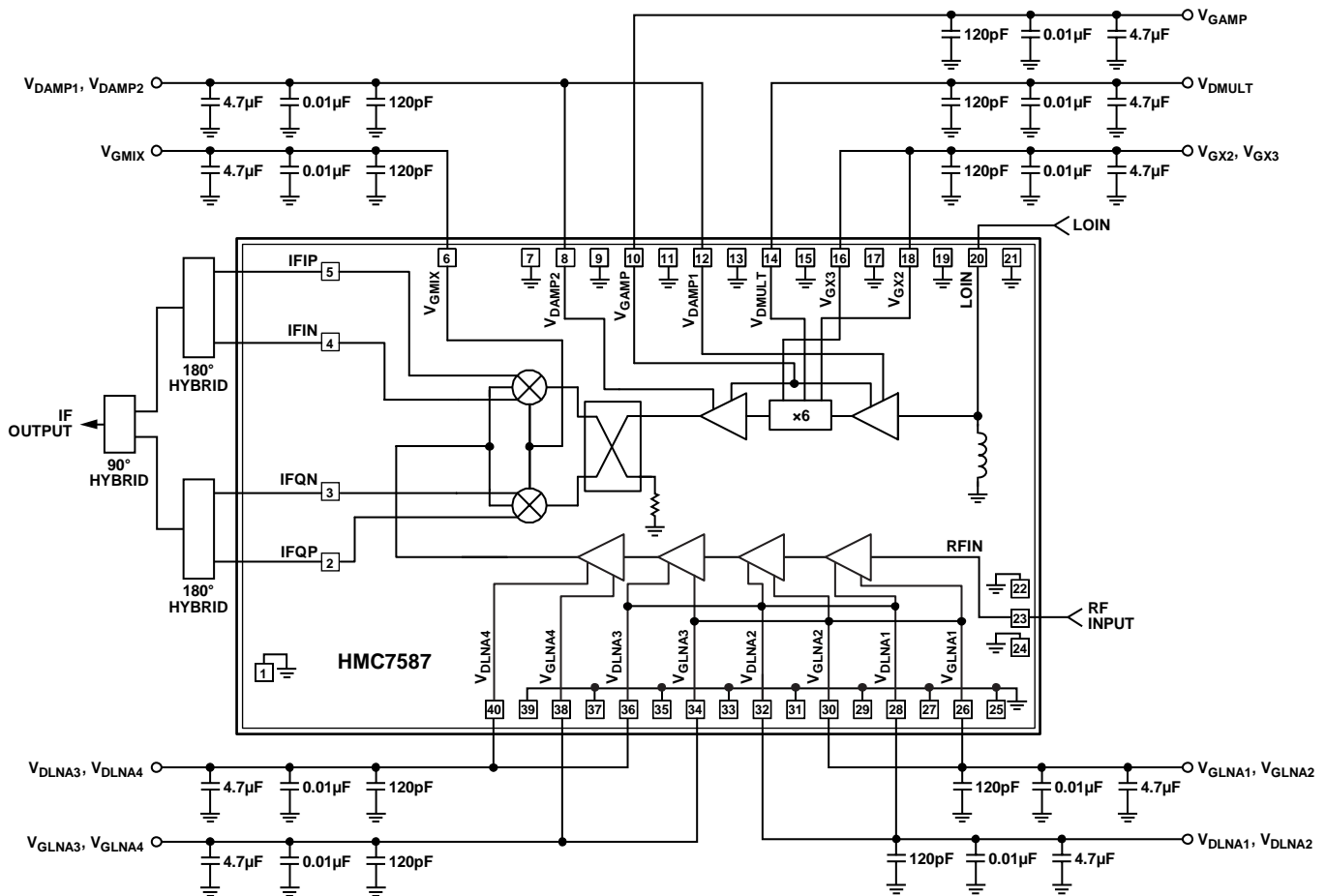

Figure 211. Typical Image Rejection Downconversion Application Circuit

13144-231

ZERO IF DIRECT CONVERSION

A typical zero IF direct conversion application circuit is shown in Figure 212. It is important to ac couple the IFIP, IFIN, IFQP, and IFQN pads to the ADC inputs. Most ADCs are designed to operate with a common-mode voltage that is above ground.

The HMC7587 I/Q outputs are ground referenced and dc coupling to a differential signal source with a common-mode output voltage other than 0 V can cause degraded RF performance and possible device damage due to electrical overstress.

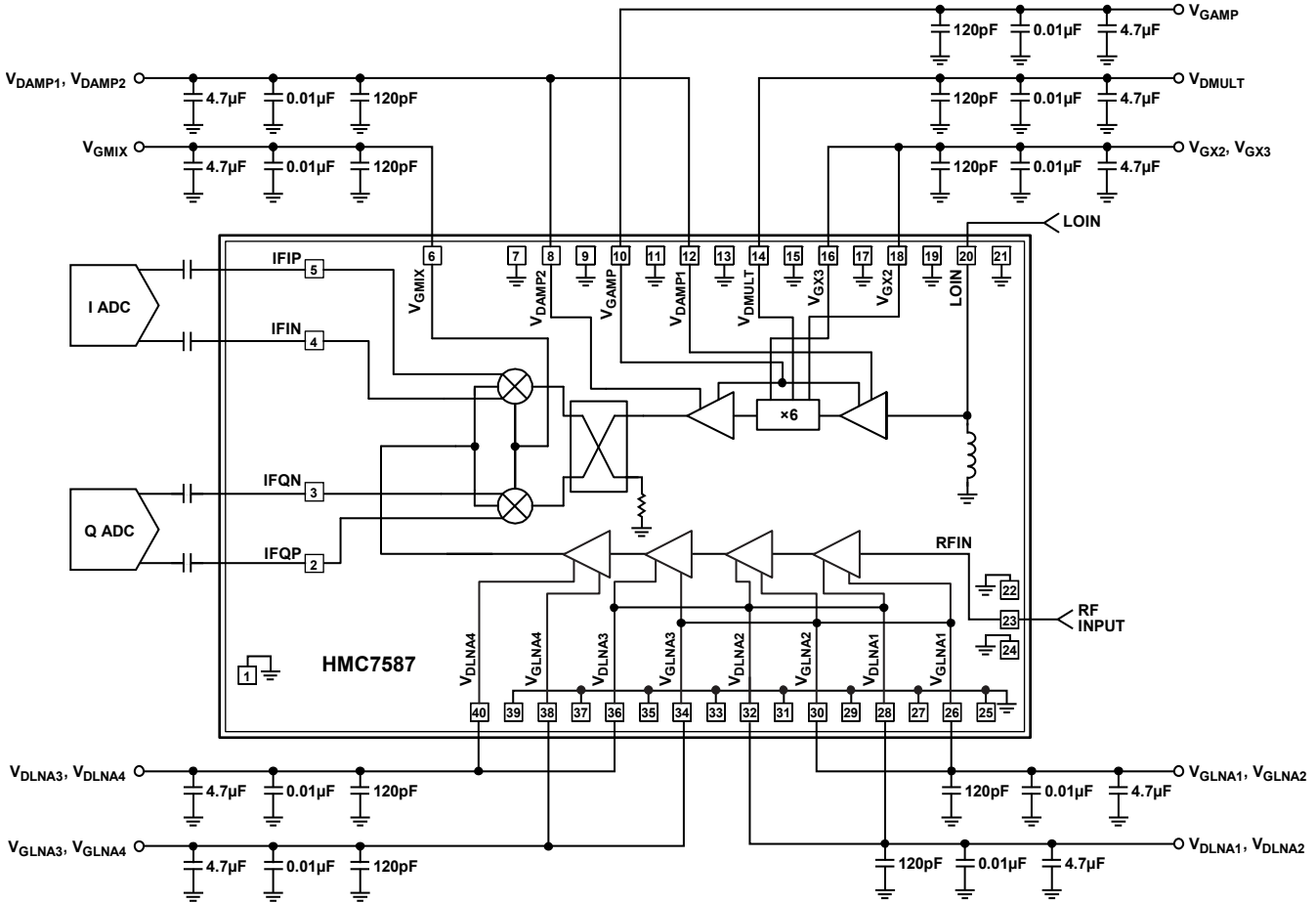

Figure 212. Typical Zero IF Direct Conversion Application Circuit

13141-232

ASSEMBLY DIAGRAM

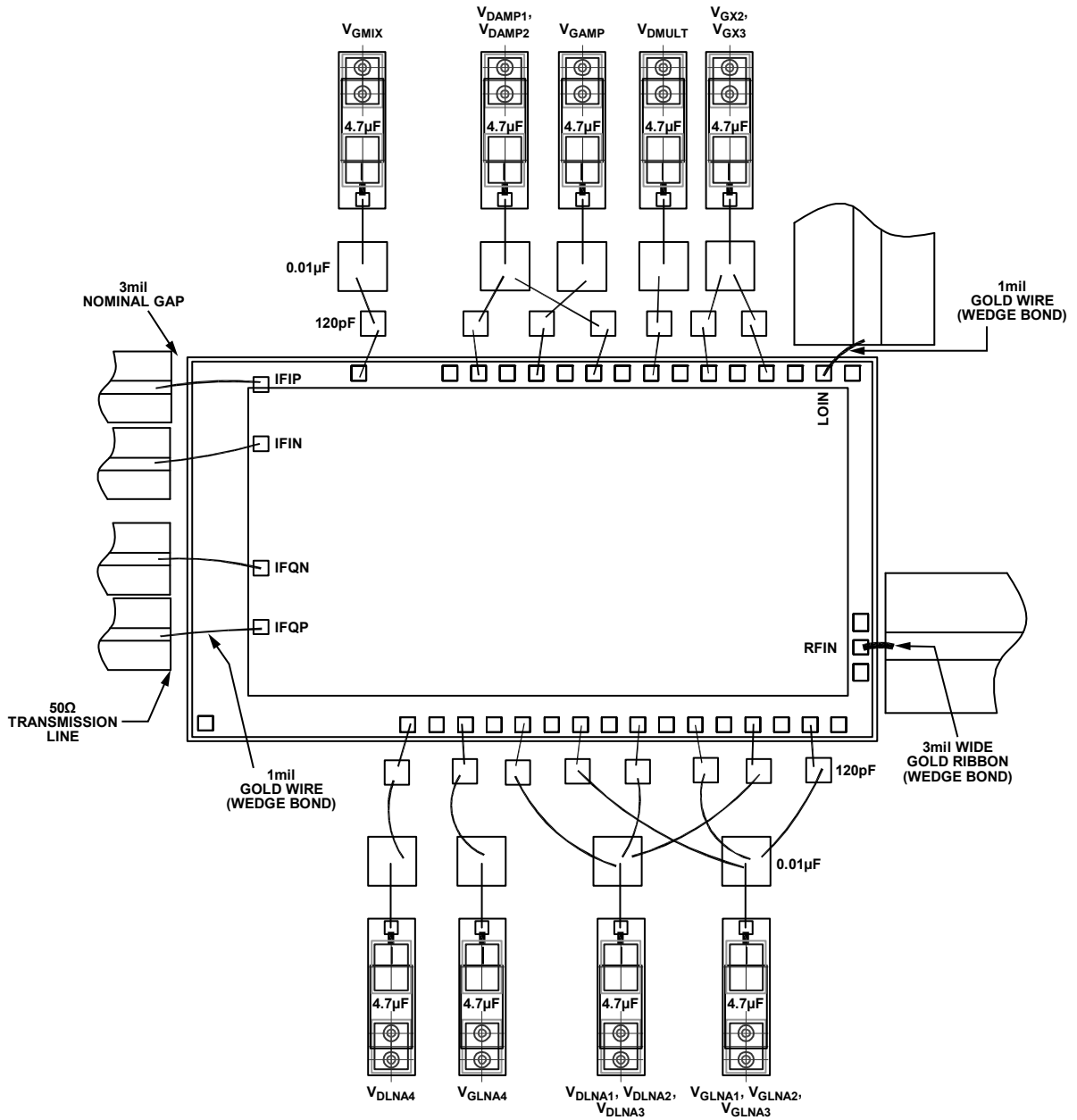

Figure 213. Assembly Diagram

13141-234

MOUNTING AND BONDING TECHNIQUES FOR MILLIMETERWAVE GaAs MMICS

Attach the die directly to the ground plane eutectically or with conductive epoxy.

To bring RF to and from the chip, use 50 Ω microstrip transmission lines on 0.127 mm (5 mil) thick alumina thin film substrates (see Figure 214).

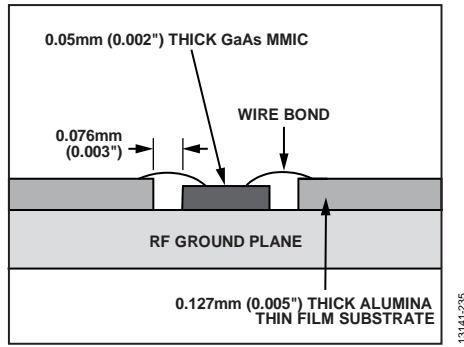

Figure 214. Routing RF Signals

To minimize bond wire length, place microstrip substrates as close to the die as possible. Typical die to substrate spacing is 0.076 mm to 0.152 mm (3 mil to 6 mil).

HANDLING PRECAUTIONS

To avoid permanent damage, adhere to the following precautions.

Storage

All bare die ship in either waffle or gel-based ESD protective containers, sealed in an ESD protective bag. After opening the sealed ESD protective bag, all die must be stored in a dry nitrogen environment.

Cleanliness

Handle the chips in a clean environment. Never use liquid cleaning systems to clean the chip.

Static Sensitivity

Follow ESD precautions to protect against ESD strikes.

Transients

Suppress instrument and bias supply transients while bias is applied. To minimize inductive pickup, use shielded signal and bias cables.

General Handling

Handle the chip on the edges only using a vacuum collet or with a sharp pair of bent tweezers. Because the surface of the chip has fragile air bridges, never touch the surface of the chip with a vacuum collet, tweezers, or fingers.

MOUNTING

The chip is back metallized and can be die mounted with gold/tin (AuSn) eutectic preforms or with electrically conductive epoxy. The mounting surface must be clean and flat.

Eutectic Die Attach

It is best to use an 80%/20% gold/tin preform with a work surface temperature of 255°C and a tool temperature of 265°C. When hot 90%/10% nitrogen/hydrogen gas is applied, maintain the tool tip temperature at 290°C. Do not expose the chip to a temperature greater than 320°C for more than 20 sec. No more than 3 sec of scrubbing is required for attachment.

Epoxy Die Attach

ABLEBOND 84-1LMIT is recommended for die attachment. Apply a minimum amount of epoxy to the mounting surface so that upon placing it into position, a thin epoxy fillet is observed around the perimeter of the chip. Cure epoxy per the schedule provided by the manufacturer.

WIRE BONDING

RF bonds made with (3 mil (0.0762 mm) \times 0.5 mil (0.0127 mm) gold ribbon are recommended for the RF ports and wedge bonds with 1 mil (0.0254 mm) diameter gold wire are recommended for the IF and LO ports. These bonds must be thermosonically bonded with a force of 40 g to 60 g. DC bonds of 1 mil (0.0254 mm) diameter, thermosonically bonded, are recommended. Create ball bonds with a force of 40 g to 50 g and wedge bonds at 18 g to 22 g. Create all bonds with a nominal stage temperature of 150°C. Apply a minimum amount of ultrasonic energy to achieve reliable bonds. Keep all bonds as possible, less than 12 mils (0.31 mm).

OUTLINE DIMENSIONS

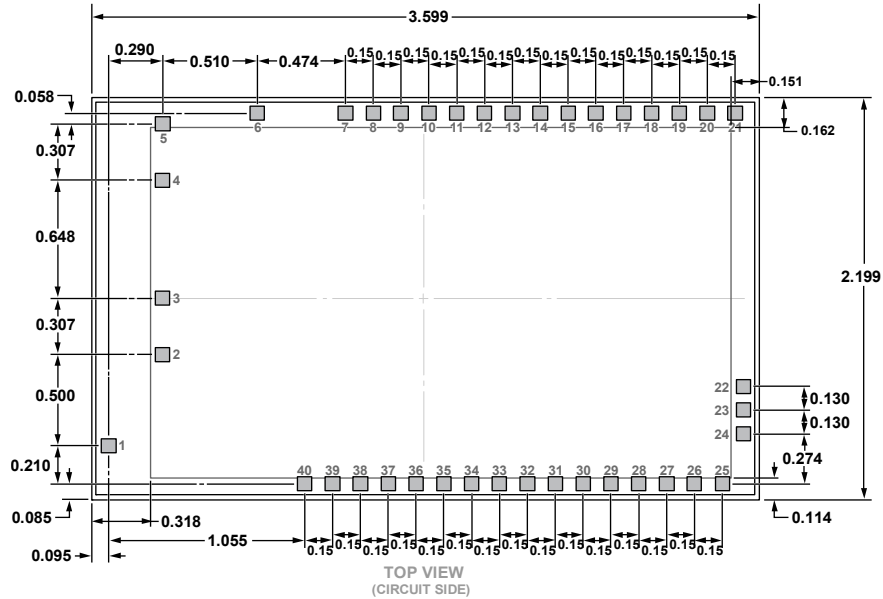

04-10-2015-A

Figure 215. 40-Pad Bare Die [CHIP]
(C-40-1)
Dimensions shown in millimeters

ORDERING GUIDE

Model ¹	Temperature Range	Package Description	Package Option ²
HMC7587	-55°C to +85°C	40-Pad Bare Die [CHIP]	C-40-1
HMC7587-SX	-55°C to +85°C	40-Pad Bare Die [CHIP]	C-40-1

¹ The HMC7587-SX consists of two pairs of the die in a gel pack for sample orders.

² This is a waffle pack option; contact Analog Devices, Inc., for additional packaging options.

Компания «Океан Электроники» предлагает заключение долгосрочных отношений при поставках импортных электронных компонентов на взаимовыгодных условиях!

Наши преимущества:

- Поставка оригинальных импортных электронных компонентов напрямую с производств Америки, Европы и Азии, а так же с крупнейших складов мира;
- Широкая линейка поставок активных и пассивных импортных электронных компонентов (более 30 млн. наименований);
- Поставка сложных, дефицитных, либо снятых с производства позиций;
- Оперативные сроки поставки под заказ (от 5 рабочих дней);
- Экспресс доставка в любую точку России;
- Помощь Конструкторского Отдела и консультации квалифицированных инженеров;
- Техническая поддержка проекта, помощь в подборе аналогов, поставка прототипов;
- Поставка электронных компонентов под контролем ВП;
- Система менеджмента качества сертифицирована по Международному стандарту ISO 9001;
- При необходимости вся продукция военного и аэрокосмического назначения проходит испытания и сертификацию в лаборатории (по согласованию с заказчиком);
- Поставка специализированных компонентов военного и аэрокосмического уровня качества (Xilinx, Altera, Analog Devices, Intersil, Interpoint, Microsemi, Actel, Aeroflex, Peregrine, VPT, Syfer, Eurofarad, Texas Instruments, MS Kennedy, Miteq, Cobham, E2V, MA-COM, Hittite, Mini-Circuits, General Dynamics и др.);

Компания «Океан Электроники» является официальным дистрибьютором и эксклюзивным представителем в России одного из крупнейших производителей разъемов военного и аэрокосмического назначения «JONHON», а так же официальным дистрибьютором и эксклюзивным представителем в России производителя высокотехнологичных и надежных решений для передачи СВЧ сигналов «FORSTAR».



JONHON

«JONHON» (основан в 1970 г.)

Разъемы специального, военного и аэрокосмического назначения:

(Применяются в военной, авиационной, аэрокосмической, морской, железнодорожной, горно- и нефтедобывающей отраслях промышленности)

«FORSTAR» (основан в 1998 г.)

ВЧ соединители, коаксиальные кабели,
кабельные сборки и микроволновые компоненты:

(Применяются в телекоммуникациях гражданского и специального назначения, в средствах связи, РЛС, а так же военной, авиационной и аэрокосмической отраслях промышленности).



Телефон: 8 (812) 309-75-97 (многоканальный)

Факс: 8 (812) 320-03-32

Электронная почта: ocean@oceanchips.ru

Web: <http://oceanchips.ru/>

Адрес: 198099, г. Санкт-Петербург, ул. Калинина, д. 2, корп. 4, лит. А