



Typical Specifications

Items		Specifications
Rating (max.)/(min.)(Resistive load)		0.15A 12V DC / 50μA 3V DC
Contact resistance (Initial / After operating life)		50mΩ max. / 100mΩ max.
Rotational torque		70±30mN·m
Operating life	Without load	10,000 cycles
	With load	10,000 cycles (0.15A 12V DC)

Product Line

Number of wafers	Poles	Positions	Changeover angle	Changeover timing	Actuator configuration	Actuator length (mm)	Minimum order unit (pcs.)		Product No.	Drawing No.
							Japan	Export		
1	2	5	30±3°	Non shorting	Round	20	60	240	SRRN151800	1
		Flat			15	SRRN152000				
	18-tooth serration	20			SRRN161100					
	Round				SRRN142100	2				
	4	3			18-tooth serration	15			SRRN134300	3

Note

All the axis are cutting shafts.

Packing Specifications

Tray

Number of packages (pcs.)		Export package measurements (mm)
1 case /Japan	1 case /export packing	
60	240	400×270×270

Dimensions

Unit:mm

No.	Style
1	

Refer to P.147 for shaft configurations.
Refer to P.148 for soldering conditions.

SRRN 6-position Vertical Type

Detector

Slide

Push

Rotary

Power

Dual-in-line
Package Type

Dimensions

Unit:mm

No.	Style
2	<p>Technical drawing of SRRN style 2. It includes three views: a top view showing terminal positions 1-6, a side view showing a total length of 16 max. with segments of 11.3, 8, 5, and 6, and a mounting hole of $M7 \times 0.75$ at a distance of $L \pm 0.5$ from the end. The front view shows a diameter of $\phi 24$ and a mounting hole diameter of $\phi 3_{-0.2}^0$. Other dimensions include 19.2, 8.4, 8, 23.6, and 5.8.</p>
3	<p>Technical drawing of SRRN style 3. It includes three views: a top view showing terminal positions 1-6, a side view showing a total length of 16 max. with segments of 11.3, 8, 5, and 6, and a mounting hole of $M7 \times 0.75$ at a distance of $L \pm 0.5$ from the end. The front view shows a diameter of $\phi 24$ and a mounting hole diameter of $\phi 3_{-0.2}^0$. Other dimensions include 19.2, 8.4, 8, 23.6, and 5.8.</p>

Terminal Configuration

Unit:mm

Common terminal	Terminal
<p>Diagram of a common terminal with dimensions: 2.4, 1.8, 0.8x1.6 hole, 0.5, and 2.4.</p>	<p>Diagram of a terminal with dimensions: 1.8, 0.8x1.6 hole, 0.5, and 2.4.</p>

Standard Circuit Diagram (Standard Poles Per Step)

Number of poles	2		3		4	
Circuit diagram						
Dummy terminals	5-position	17 18	4-position	—	3-position	—
	6-position	—				

Note

The mark in the above table indicate a stopper with the shaft turned fully counterclockwise when viewed from direction A of the diagrams.

18-tooth Serration Shaft

The shaft shows the position in which it is turned fully counterclockwise.

Cutting Shaft

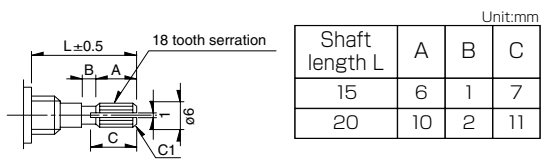

Details About Serration

- (1) The mold dimensions of standard serration and the dimensions of test jigs are as shown in the figure at left.
- (2) Position of the serration bottom
When the shaft is turned fully counterclockwise, the position of the serration bottom is on the AA line.
- (3) Slitting angle
The slitting angle (position) is not specified.

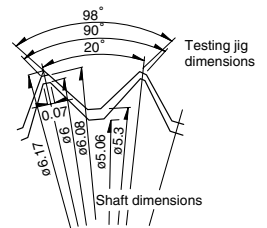

Round Shaft

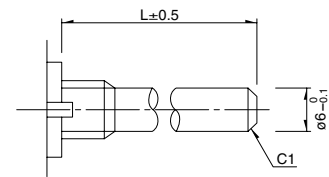

Flat Shaft

The shaft shows the position in which it is turned fully counterclockwise.

Cutting Shaft

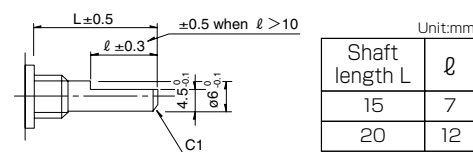

Shaft flatten angle		

Note





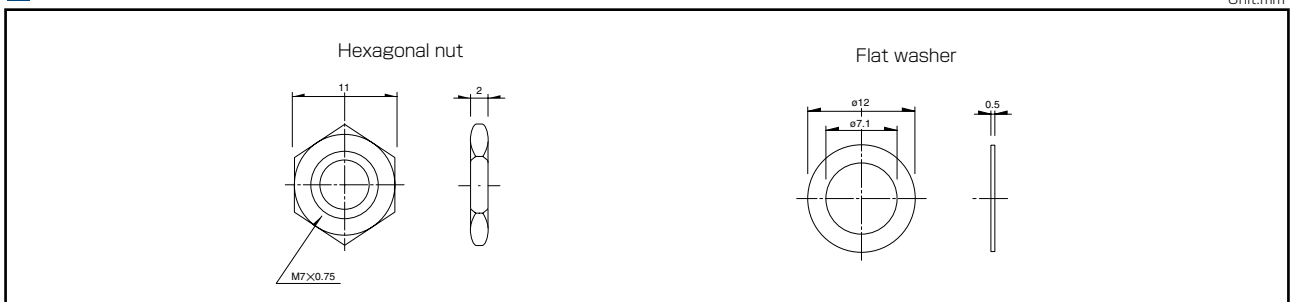







SRRM Series are based on (panel lug).

Attached Parts



Rotary Switches

List of Varieties

Series	SRBD	SRBQ		SRBM		SRBV	SRRM	SRRN																																																
		Insertion	Reflow type	Rotary	Pulse																																																			
Photo																																																								
Angle of throw	36°	40±3°		30±3°	18±3°	30±3°																																																		
Number of poles	1		1, 2		1		1, 2, 3, 4	2, 3, 4																																																
Rotational torque	13±5mN·m	6±3mN·m 13±5mN·m		40±20mN·m 15±7mN·m		30±15mN·m	80±30mN·m (Shorting) 70±30mN·m (Non shorting)	70±30mN·m																																																
Dimensions (mm)	W	10		10		16.2	—	—																																																
	D	11.4		12.5		18.5																																																		
	H	12.4		11		7.5																																																		
Operating temperature range	-25°C to +85°C	-10°C to +60°C		-30°C to +85°C		-10°C to +85°C	-10°C to +60°C	-30°C to +65°C																																																
Automotive use	—	—		—		—	—	—																																																
Life cycle																																																								
Rating (max.)/(min.) (Resistive load)	1mA 5V DC 50µA 3V DC	0.1A 16V DC 50µA 3V DC				0.3A 16V DC 50µA 3V DC		0.25A 30V DC 50µA 3V DC	0.15A 12V DC 50µA 3V DC																																															
Durability	Operating life without load	10,000 cycles 250mΩ max.	10,000 cycles 100mΩ max.		30,000 cycles 100mΩ max.	10,000 cycles 100mΩ max.	10,000 cycles 40mΩ max.	10,000 cycles 70mΩ max.																																																
	Operating life with load Load: as rating	10,000 cycles 250mΩ max.	10,000 cycles 100mΩ max.	10,000 cycles 150mΩ max.		10,000 cycles 60mΩ max.	10,000 cycles 100mΩ max.	10,000 cycles 100mΩ max.																																																
Electrical performance	Initial contact resistance	200mΩ max.	50mΩ max.				20mΩ max.	50mΩ max.																																																
	Insulation resistance	100MΩ min. 100V DC					100MΩ min. 500V DC																																																	
	Voltage proof	100V AC for 1minute					500V AC for 1minute																																																	
Mechanical performance	Terminal strength	3N for 1minute	5N for 1minute				10N for 1minute	5N for 1minute																																																
	Actuator strength	Operating direction	—	—	0.5N·m	—	0.6N·m	1N·m																																																
		Pulling direction	50N	20N	100N																																																			
	Wobble of actuator	Load at the tip of shaft SRRM, SRBM, SRRN: 5N, SRBQ, SRBV: 1N The below table shows for SRRM, SRBM, SRRN The below table shows for SRBQ The below table shows for SRBV																																																						
<table border="1" style="width: 100%; border-collapse: collapse;"> <thead> <tr> <th>Measuring position from mounting surface</th> <th>Shaft wobble (max. value)</th> <th>Applicable mounting dimension</th> <th>Distance from mounting surface to the tip of shaft</th> <th>Shaft wobble (max. value)</th> <th>Measuring position from mounting surface</th> <th>Shaft wobble (max. value)</th> <th>Applicable mounting dimension</th> </tr> </thead> <tbody> <tr> <td>10</td> <td>0.17</td> <td>15</td> <td>below 5</td> <td>0.5</td> <td>10</td> <td>0.2</td> <td>15</td> </tr> <tr> <td>15</td> <td>0.25</td> <td>20</td> <td>above 5 and below 10</td> <td>0.9</td> <td>15</td> <td>0.3</td> <td>20</td> </tr> <tr> <td>20</td> <td>0.35</td> <td>25</td> <td>above 10 and below 15</td> <td>1.2</td> <td>20</td> <td>0.4</td> <td>25</td> </tr> <tr> <td>25</td> <td>0.42</td> <td>30</td> <td></td> <td></td> <td></td> <td></td> <td></td> </tr> <tr> <td>30</td> <td>0.5</td> <td>above 35</td> <td></td> <td></td> <td></td> <td></td> <td></td> </tr> </tbody> </table> <p style="text-align: right;">Unit:mm</p>									Measuring position from mounting surface	Shaft wobble (max. value)	Applicable mounting dimension	Distance from mounting surface to the tip of shaft	Shaft wobble (max. value)	Measuring position from mounting surface	Shaft wobble (max. value)	Applicable mounting dimension	10	0.17	15	below 5	0.5	10	0.2	15	15	0.25	20	above 5 and below 10	0.9	15	0.3	20	20	0.35	25	above 10 and below 15	1.2	20	0.4	25	25	0.42	30						30	0.5	above 35					
Measuring position from mounting surface	Shaft wobble (max. value)	Applicable mounting dimension	Distance from mounting surface to the tip of shaft	Shaft wobble (max. value)	Measuring position from mounting surface	Shaft wobble (max. value)	Applicable mounting dimension																																																	
10	0.17	15	below 5	0.5	10	0.2	15																																																	
15	0.25	20	above 5 and below 10	0.9	15	0.3	20																																																	
20	0.35	25	above 10 and below 15	1.2	20	0.4	25																																																	
25	0.42	30																																																						
30	0.5	above 35																																																						
Environmental performance	Cold	-40°C 500h	-20°C 96h	-40°C 96h	-20°C 96h		-40°C 96h																																																	
	Dry heat	85°C 500h	85°C 96h																																																					
	Damp heat	60°C, 90 to 95%RH 500h	40°C, 90 to 95%RH 96h																																																					
Page	133	135	137	140	142	145																																																		

Rotary Switches Soldering Conditions 148
 Rotary Switches Cautions 149

■ Example of Reflow Soldering Condition

1. Heating method: Double heating method with infrared heater.
2. Temperature measurement: Thermocouple $\phi 0.1$ to 0.2 CA (K) or CC (T) at soldering portion (copper foil surface).
A heat resisting tape should be used for fixed measurement.
3. Temperature profile

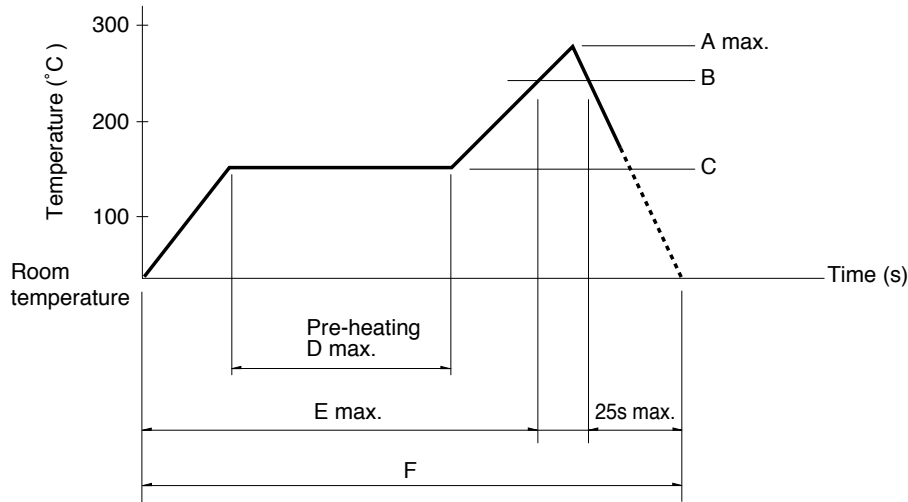

Series (Reflow type)	A (°C) 3s max.	B (°C)	C (°C)	D (s)	E (s)	F (s)
SRBQ	250	200	150±5	80 to 100	—	—

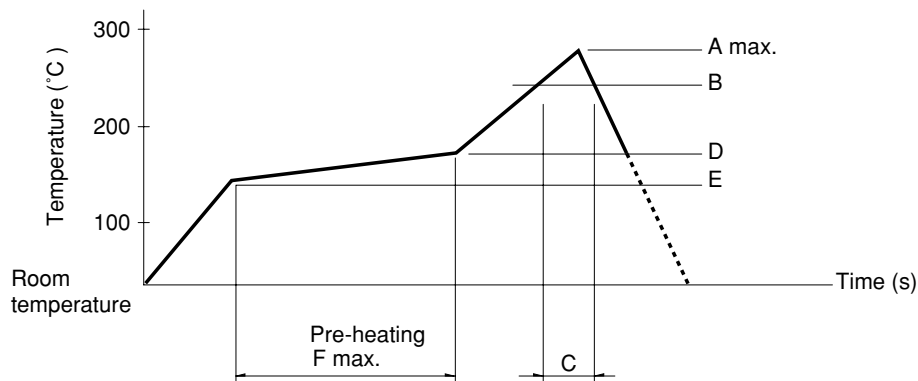

Series (Reflow type)	A (°C) 3s max.	B (°C)	C (s)	D (°C)	E (°C)	F (s)
SRBD	260	230	40	180	150	120

- Notes**
1. The condition mentioned above is the temperature on the mounting surface of a PC board. There are cases where the PC board's temperature greatly differs from that of the switch, depending on the PC board's material, size, thickness, etc. The above-stated conditions shall also apply to switch surface temperatures.
 2. Soldering conditions differ depending on reflow soldering machines. Prior verification of soldering condition is highly recommended.

■ Reference for Hand Soldering

Series	Soldering temperature	Soldering time
SRBQ, SRBM, SRBV, SRRM, SRRN	350±10°C	3+1/0s
SRBQ (Reflow type)	350±5°C	3s max.

■ Reference for Dip Soldering

(For PC board terminal types)

Series	Items		Dip soldering	
	Preheating temperature	Preheating time	Soldering temperature	Duration of immersion
SRBM	100°C max.	60s max.	260±5°C	5s max.
SRBV, SRRM, SRRN	—	—	260±5°C	10±1s
SRBQ	—	—	260±5°C	5±1s

Компания «Океан Электроники» предлагает заключение долгосрочных отношений при поставках импортных электронных компонентов на взаимовыгодных условиях!

Наши преимущества:

- Поставка оригинальных импортных электронных компонентов напрямую с производств Америки, Европы и Азии, а так же с крупнейших складов мира;
- Широкая линейка поставок активных и пассивных импортных электронных компонентов (более 30 млн. наименований);
- Поставка сложных, дефицитных, либо снятых с производства позиций;
- Оперативные сроки поставки под заказ (от 5 рабочих дней);
- Экспресс доставка в любую точку России;
- Помощь Конструкторского Отдела и консультации квалифицированных инженеров;
- Техническая поддержка проекта, помощь в подборе аналогов, поставка прототипов;
- Поставка электронных компонентов под контролем ВП;
- Система менеджмента качества сертифицирована по Международному стандарту ISO 9001;
- При необходимости вся продукция военного и аэрокосмического назначения проходит испытания и сертификацию в лаборатории (по согласованию с заказчиком);
- Поставка специализированных компонентов военного и аэрокосмического уровня качества (Xilinx, Altera, Analog Devices, Intersil, Interpoint, Microsemi, Actel, Aeroflex, Peregrine, VPT, Syfer, Eurofarad, Texas Instruments, MS Kennedy, Miteq, Cobham, E2V, MA-COM, Hittite, Mini-Circuits, General Dynamics и др.);

Компания «Океан Электроники» является официальным дистрибьютором и эксклюзивным представителем в России одного из крупнейших производителей разъемов военного и аэрокосмического назначения «JONHON», а так же официальным дистрибьютором и эксклюзивным представителем в России производителя высокотехнологичных и надежных решений для передачи СВЧ сигналов «FORSTAR».



JONHON

«JONHON» (основан в 1970 г.)

Разъемы специального, военного и аэрокосмического назначения:

(Применяются в военной, авиационной, аэрокосмической, морской, железнодорожной, горно- и нефтедобывающей отраслях промышленности)

«FORSTAR» (основан в 1998 г.)

ВЧ соединители, коаксиальные кабели, кабельные сборки и микроволновые компоненты:

(Применяются в телекоммуникациях гражданского и специального назначения, в средствах связи, РЛС, а так же военной, авиационной и аэрокосмической отраслях промышленности).



Телефон: 8 (812) 309-75-97 (многоканальный)

Факс: 8 (812) 320-03-32

Электронная почта: ocean@oceanchips.ru

Web: <http://oceanchips.ru/>

Адрес: 198099, г. Санкт-Петербург, ул. Калинина, д. 2, корп. 4, лит. А