150mA 10V INPUT LDO REGULATOR

NO.EA-245-160324

OUTLINE

The RP171x Series are CMOS-based LDO regulators featuring 150mA output current. Because of the 10V maximum input voltage, RP171x can be used in 2 cell lithium-ion battery powered portable appliances and besides a portable equipment. The supply current is Typ. 23 μ A though an excellent response characteristics.

The output voltage range from 1.2V is possible. The output voltage accuracy and temperature-drift coefficient of output voltage of the RP171x Series are excellent.

RP171x has a fold-back protection circuit and a thermal shutdown circuit. Moreover, a standby mode with ultra low supply current can be realized with the chip enable function.

SC-88A and SOT-23-5 with high power dissipation packages are available.

FEATURES

- Supply Current Typ. 23 μ A
- Standby Mode Typ. 0.1 μ A
- Dropout Voltage..... Typ. 0.20V ($I_{OUT}=100\text{mA}$, $V_{OUT}=3.0\text{V}$)
Typ. 0.40V ($I_{OUT}=150\text{mA}$, $V_{OUT}=2.8\text{V}$)
- Ripple Rejection Typ. 70dB ($f=1\text{kHz}$)
- Temperature-Drift Coefficient of Output Voltage Typ. $\pm 80\text{ppm}/^\circ\text{C}$
- Line Regulation Typ. 0.02%/V
- Output Voltage Accuracy $\pm 1.0\%$
- Packages..... SC-88A, SOT-23-5
- Input Voltage Range 2.6V to 10.0V
- Output Voltage Range 1.2V to 6.0V (0.1V steps)
(For other voltages, please refer to MARK INFORMATIONS.)
- Built-in Fold Back Protection Circuit..... Typ. 40mA (Current at short mode)
- Built-in Thermal Shutdown Circuit..... Shutdown Temperature at 165 $^\circ\text{C}$
- Built-in Constant Slope Circuit (Soft-start Function)
- Ceramic capacitors are recommended to be used with this IC 1.0 μ F or more

APPLICATIONS

- Power source for portable communication equipment.
- Power source for electrical appliances such as cameras, VCRs and camcorders.
- Power source for battery-powered equipment.
- Power source for home appliances.

RP171x

NO.EA-245-160324

BLOCK DIAGRAMS



SELECTION GUIDE

The output voltage, auto discharge function, and package, etc. for the ICs can be selected at the user's request.

Product Name	Package	Quantity per Reel	Pb Free	Halogen Free
RP171Qxx2*-TR-FE	SC-88A	3,000 pcs	Yes	Yes
RP171Nxx1*-TR-FE	SOT-23-5	3,000 pcs	Yes	Yes

xx: The output voltage can be designated in the range from 1.2V(12) to 6.0V(60) in 0.1V steps.
(For other voltages, please refer to MARK INFORMATIONS.)

* : The auto discharge function at off state are options as follows.
(B) without auto discharge function at off state
(D) with auto discharge function at off state

PIN CONFIGURATIONS



PIN DESCRIPTIONS

• SC-88A

Pin No	Symbol	Pin Description
1	CE	Chip Enable Pin ("H" Active)
2	NC	No Connection
3	GND	Ground Pin
4	V _{OUT}	Output Pin
5	V _{DD}	Input Pin

• SOT-23-5

Pin No	Symbol	Pin Description
1	V _{DD}	Input Pin
2	GND	Ground Pin
3	CE	Chip Enable Pin ("H" Active)
4	NC	No Connection
5	V _{OUT}	Output Pin

ABSOLUTE MAXIMUM RATINGS

Symbol	Item	Rating	Unit
V_{IN}	Input Voltage	12	V
V_{CE}	Input Voltage (CE Pin)	12	V
V_{OUT}	Output Voltage	-0.3 to $V_{IN}+0.3$	V
I_{OUT}	Output Current	330	mA
P_D	Power Dissipation* (SC-88A)	380	mW
	Power Dissipation* (SOT-23-5)	420	
T_{opt}	Operating Temperature Range	-40 to 85	°C
T_{stg}	Storage Temperature Range	-55 to 125	°C

*) For Power Dissipation, please refer to PACKAGE INFORMATION.

ABSOLUTE MAXIMUM RATINGS

Electronic and mechanical stress momentarily exceeded absolute maximum ratings may cause the permanent damages and may degrade the life time and safety for both device and system using the device in the field.

The functional operation at or over these absolute maximum ratings is not assured.

RECOMMENDED OPERATING CONDITIONS (ELECTRICAL CHARACTERISTICS)

All of electronic equipment should be designed that the mounted semiconductor devices operate within the recommended operating conditions. The semiconductor devices cannot operate normally over the recommended operating conditions, even if when they are used over such conditions by momentary electronic noise or surge. And the semiconductor devices may receive serious damage when they continue to operate over the recommended operating conditions.

ELECTRICAL CHARACTERISTICS

V_{IN}=Set V_{OUT}+1V, I_{OUT}=1mA, unless otherwise noted.

The specifications in are guaranteed by Design Engineering at -40°C ≤ T_a ≤ 85°C.

RP171xxxxB/D

T_{opt}=25°C

Symbol	Item	Conditions	Min.	Typ.	Max.	Unit	
V _{OUT}	Output Voltage	T _{opt} =25°C	V _{OUT} > 1.5V	×0.99		×1.01	V
			V _{OUT} ≤ 1.5V	-15		+15	mV
		-40°C ≤ T _{opt} ≤ 85°C	V _{OUT} > 1.5V	×0.974		×1.023	V
			V _{OUT} ≤ 1.5V	-40		+35	mV
I _{OUT}	Output Current		150			mA	
ΔV _{OUT} /ΔI _{OUT}	Load Regulation	0.1mA ≤ I _{OUT} ≤ 150mA		5	40	mV	
V _{DIF}	Dropout Voltage	I _{OUT} =150mA	1.2V ≤ V _{OUT} < 1.3V		-	1.400	V
			1.3V ≤ V _{OUT} < 1.5V		-	1.300	
			1.5V ≤ V _{OUT} < 1.8V		-	1.100	
			1.8V ≤ V _{OUT} < 2.3V		-	0.800	
			2.3V ≤ V _{OUT} < 3.0V		0.400	0.580	
			3.0V ≤ V _{OUT} < 4.0V		0.300	0.480	
			4.0V ≤ V _{OUT} ≤ 6.0V		0.250	0.400	
I _{SS}	Supply Current	I _{OUT} =0mA		23	40	μA	
I _{standby}	Standby Current	V _{IN} =10.0V, V _{CE} =GND		0.1	1.0	μA	
ΔV _{OUT} /ΔV _{IN}	Line Regulation	Set V _{OUT} +0.5V ≤ V _{IN} ≤ 10.0V (In case that V _{OUT} ≤ 2.1V, 2.6V ≤ V _{IN} ≤ 10.0V)		±0.02	±0.2	%/V	
RR	Ripple Rejection	f=1kHz, Ripple 0.2Vp-p, I _{OUT} =30mA (In case that V _{OUT} < 2.0V, V _{IN} =3.0V)		70		dB	
V _{IN}	Input Voltage		2.6		10	V	
ΔV _{OUT} /ΔT _{opt}	Output Voltage Temperature Coefficient	-40°C ≤ T _{opt} ≤ 85°C		±80		ppm/°C	
I _{SC}	Short Current Limit	V _{OUT} =0V		40		mA	
I _{PD}	CE Pull-down Current			0.30		μA	
V _{CEH}	CE Input Voltage "H"		1.7			V	
V _{CEL}	CE Input Voltage "L"				0.8	V	
T _{TSD}	Thermal Shutdown Temperature	Junction Temperature		165		°C	
T _{TSR}	Thermal Shutdown Released Temperature	Junction Temperature		110		°C	
en	Output Noise	BW=10Hz to 100kHz		100		μVrms	
R _{LOW}	Low Output Nch Tr. ON Resistance (of D version)	V _{IN} =7.0V V _{CE} =0V		250		Ω	

All of unit are tested and specified under load conditions such that T_j≈T_{opt}=25°C except for Output Noise, Ripple Rejection, Output Voltage Temperature Coefficient and Thermal Shutdown.

TYPICAL APPLICATION



(External Components)

C2 1.0 μ F MURATA: GRM155B31A105KE15

TECHNICAL NOTES

When using these ICs, consider the following points:

Phase Compensation

In these ICs, phase compensation is made for securing stable operation even if the load current is varied. For this purpose, use a capacitor C2 with 1.0 μ F or more and good ESR (Equivalent Series Resistance).

(Note: If additional ceramic capacitors are connected with parallel to the output pin with an output capacitor for phase compensation, the operation might be unstable. Because of this, test these ICs with as same external components as ones to be used on the PCB.)

PCB Layout

Make V_{DD} and GND lines sufficient. If their impedance is high, noise pickup or unstable operation may result. Connect a capacitor C1 with a capacitance value as much as 1.0 μ F or more between V_{DD} and GND pin, and as close as possible to the pins.

Set external components, especially the output capacitor C2, as close as possible to the ICs, and make wiring as short as possible.

PACKAGE INFORMATION

• Power Dissipation (SC-88A)

Power Dissipation (P_D) depends on conditions of mounting on board. This specification is based on the measurement at the condition below:

Measurement Conditions:

	Standard Land Pattern
Environment	Mounting on Board (Wind velocity=0m/s)
Board Material	Glass cloth epoxy plastic (Double Layers)
Board Dimensions	40mm × 40mm × 1.6mm
Copper Ratio	Top side: Approx. 50%, Back side: Approx. 50%
Through-hole	φ0.5mm × 44pcs

Measurement Results:

($T_a=25^\circ\text{C}$)

	Standard Land Pattern	Free Air
Power Dissipation	380mW ($T_{j\max}=125^\circ\text{C}$) 475mW ($T_{j\max}=150^\circ\text{C}$)	150mW
Thermal Resistance	$\theta_{ja}=(125-25^\circ\text{C})/0.38\text{W}=263^\circ\text{C/W}$	$\theta_{ja}=(125-25^\circ\text{C})/0.15\text{W}=667^\circ\text{C/W}$
	$\theta_{jc}=75^\circ\text{C/W}$	-

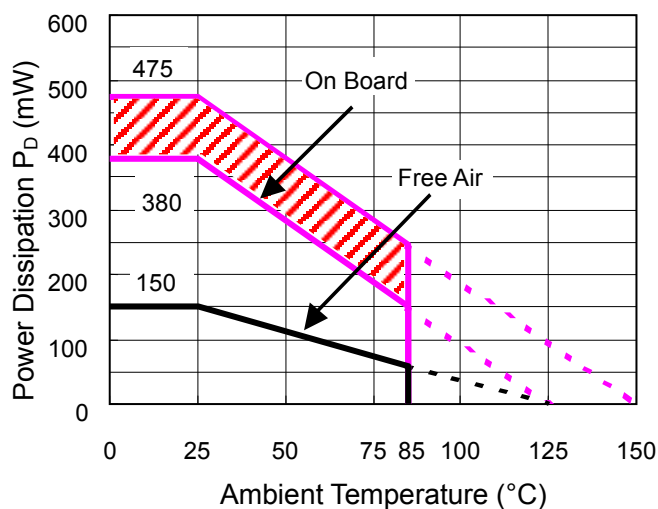

Power Dissipation

The above graph shows the Power Dissipation of the package under the conditions of $T_{j\max}=125^\circ\text{C}$ and $T_{j\max}=150^\circ\text{C}$.

The operation of the IC within the shaded range in the graph might have an affect on the IC's lifetime. The operation time of the IC must be remained within the time limit described in the table below.

Operating Time	Estimated Years (Operating 4 hours/day)
13,000 hours	9 years

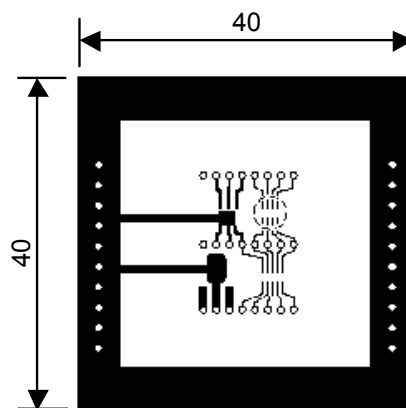

Measurement Board Pattern

⊙ IC Mount Area (Unit: mm)

● RP171Q Series Mark Specification Table (SC-88A)

RP171Qxx2B

Product Name	①② ③④	Volta ge
RP171Q122B	AC01	1.2V
RP171Q122B5	AC02	1.25V
RP171Q132B	AC03	1.3V
RP171Q142B	AC04	1.4V
RP171Q152B	AC05	1.5V
RP171Q162B	AC06	1.6V
RP171Q172B	AC07	1.7V
RP171Q182B	AC08	1.8V
RP171Q182B5	AC09	1.85V
RP171Q192B	AC10	1.9V
RP171Q202B	AC11	2.0V
RP171Q212B	AC12	2.1V
RP171Q222B	AC13	2.2V
RP171Q232B	AC14	2.3V
RP171Q242B	AC15	2.4V
RP171Q252B	AC16	2.5V
RP171Q262B	AC17	2.6V
RP171Q272B	AC18	2.7V
RP171Q282B	AC19	2.8V
RP171Q282B5	AC20	2.85V
RP171Q292B	AC21	2.9V

Product Name	①② ③④	Volta ge
RP171Q302B	AC22	3.0V
RP171Q312B	AC23	3.1V
RP171Q322B	AC24	3.2V
RP171Q332B	AC25	3.3V
RP171Q342B	AC26	3.4V
RP171Q352B	AC27	3.5V
RP171Q362B	AC28	3.6V
RP171Q372B	AC29	3.7V
RP171Q382B	AC30	3.8V
RP171Q392B	AC31	3.9V
RP171Q402B	AC32	4.0V
RP171Q412B	AC33	4.1V
RP171Q422B	AC34	4.2V
RP171Q432B	AC35	4.3V
RP171Q442B	AC36	4.4V
RP171Q452B	AC37	4.5V
RP171Q462B	AC38	4.6V
RP171Q472B	AC39	4.7V
RP171Q482B	AC40	4.8V
RP171Q492B	AC41	4.9V

Product Name	①② ③④	Volta ge
RP171Q502B	AC42	5.0V
RP171Q512B	AC43	5.1V
RP171Q522B	AC44	5.2V
RP171Q532B	AC45	5.3V
RP171Q542B	AC46	5.4V
RP171Q552B	AC47	5.5V
RP171Q562B	AC48	5.6V
RP171Q572B	AC49	5.7V
RP171Q582B	AC50	5.8V
RP171Q592B	AC51	5.9V
RP171Q602B	AC52	6.0V

RP171Qxx2D

Product Name	①② ③④	Volta ge
RP171Q122D	AD01	1.2V
RP171Q122D5	AD02	1.25V
RP171Q132D	AD03	1.3V
RP171Q142D	AD04	1.4V
RP171Q152D	AD05	1.5V
RP171Q162D	AD06	1.6V
RP171Q172D	AD07	1.7V
RP171Q182D	AD08	1.8V
RP171Q182D5	AD09	1.85V
RP171Q192D	AD10	1.9V
RP171Q202D	AD11	2.0V
RP171Q212D	AD12	2.1V
RP171Q222D	AD13	2.2V
RP171Q232D	AD14	2.3V
RP171Q242D	AD15	2.4V
RP171Q252D	AD16	2.5V
RP171Q262D	AD17	2.6V
RP171Q272D	AD18	2.7V
RP171Q282D	AD19	2.8V
RP171Q282D5	AD20	2.85V
RP171Q292D	AD21	2.9V

Product Name	①② ③④	Volta ge
RP171Q302D	AD22	3.0V
RP171Q312D	AD23	3.1V
RP171Q322D	AD24	3.2V
RP171Q332D	AD25	3.3V
RP171Q342D	AD26	3.4V
RP171Q352D	AD27	3.5V
RP171Q362D	AD28	3.6V
RP171Q372D	AD29	3.7V
RP171Q382D	AD30	3.8V
RP171Q392D	AD31	3.9V
RP171Q402D	AD32	4.0V
RP171Q412D	AD33	4.1V
RP171Q422D	AD34	4.2V
RP171Q432D	AD35	4.3V
RP171Q442D	AD36	4.4V
RP171Q452D	AD37	4.5V
RP171Q462D	AD38	4.6V
RP171Q472D	AD39	4.7V
RP171Q482D	AD40	4.8V
RP171Q492D	AD41	4.9V

Product Name	①② ③④	Volta ge
RP171Q502D	AD42	5.0V
RP171Q512D	AD43	5.1V
RP171Q522D	AD44	5.2V
RP171Q532D	AD45	5.3V
RP171Q542D	AD46	5.4V
RP171Q552D	AD47	5.5V
RP171Q562D	AD48	5.6V
RP171Q572D	AD49	5.7V
RP171Q582D	AD50	5.8V
RP171Q592D	AD51	5.9V
RP171Q602D	AD52	6.0V

RP171x

NO.EA-245-160324

• Power Dissipation (SOT-23-5)

Power Dissipation (P_D) depends on conditions of mounting on board. This specification is based on the measurement at the condition below:

(Power Dissipation (SOT-23-5) is substitution of SOT-23-6.)

Measurement Conditions:

	Standard Land Pattern
Environment	Mounting on Board (Wind velocity=0m/s)
Board Material	Glass cloth epoxy plastic (Double sided)
Board Dimensions	40mm × 40mm × 1.6mm
Copper Ratio	Top side: Approx. 50%, Back side: Approx. 50%
Through-holes	φ 0.5mm × 44pcs

Measurement Results:

($T_a=25^\circ\text{C}$)

	Standard Land Pattern	Free Air
Power Dissipation	420mW ($T_{j\max}=125^\circ\text{C}$) 525mW ($T_{j\max}=150^\circ\text{C}$)	250mW
Thermal Resistance	$\theta_{ja} = (125-25^\circ\text{C})/0.42\text{W} = 238^\circ\text{C/W}$	400 $^\circ\text{C/W}$



Power Dissipation

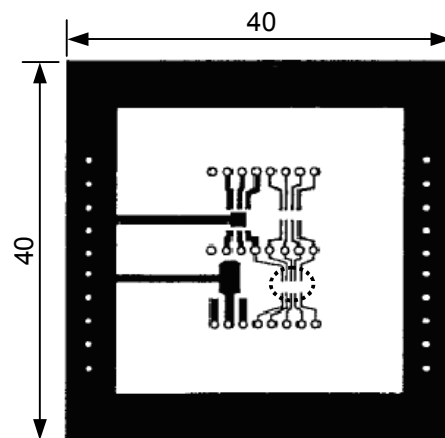

Measurement Board Pattern

○ IC Mount Area (Unit: mm)

The above graph shows the Power Dissipation of the package under the conditions of $T_{j\max}=125^\circ\text{C}$ and $T_{j\max}=150^\circ\text{C}$.

The operation of the IC within the shaded range in the graph might have an affect on the IC's lifetime. The operation time of the IC must be remained within the time limit described in the table below.

Operating Time	Estimated Years (Operating 4 hours/day)
13,000 hours	9 years

• Package Dimensions (SOT-23-5)

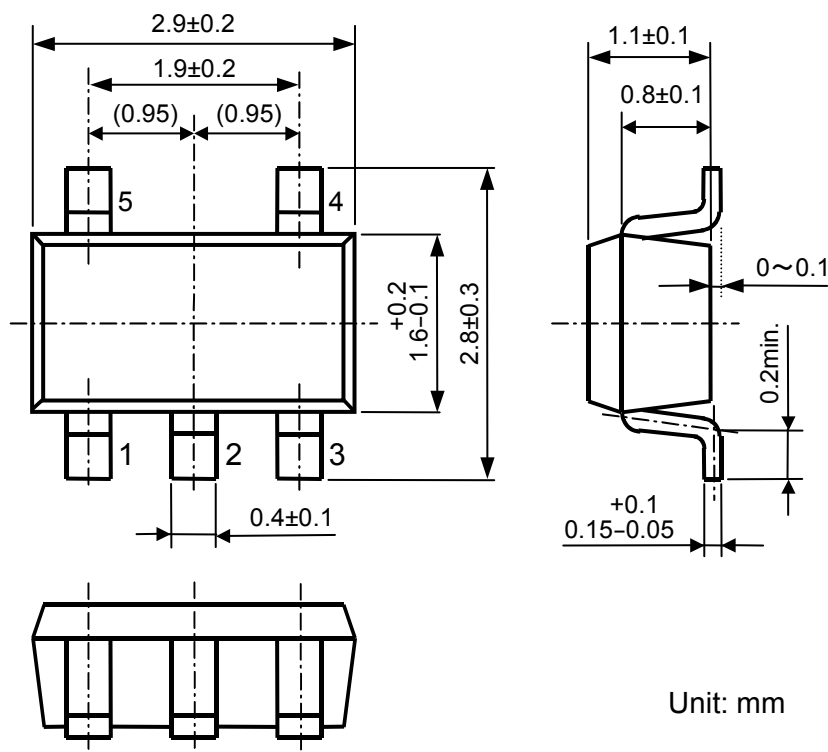

• Mark Specification (SOT-23-5)

①②③: Product Code ... Refer to "Mark Specification Table".

④⑤: Lot Number ... Alphanumeric Serial Number

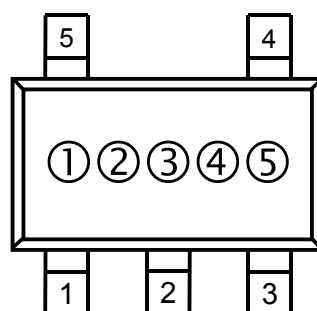

RP171x

NO.EA-245-160324

• RP171N Series Mark Specification Table (SOT-23-5)**RP171Nxx1B**

Product Name	①② ③	Volta ge
RP171N121B	JAA	1.2V
RP171N121B5	JAB	1.25V
RP171N131B	JAC	1.3V
RP171N141B	JAD	1.4V
RP171N151B	JAE	1.5V
RP171N161B	JAF	1.6V
RP171N171B	JAG	1.7V
RP171N181B	JAH	1.8V
RP171N181B5	JAJ	1.85V
RP171N191B	JAK	1.9V
RP171N201B	JAL	2.0V
RP171N211B	JAM	2.1V
RP171N221B	JAN	2.2V
RP171N231B	JAP	2.3V
RP171N241B	JAQ	2.4V
RP171N251B	JAR	2.5V
RP171N261B	JAS	2.6V
RP171N271B	JAT	2.7V
RP171N281B	JAU	2.8V
RP171N281B5	JAV	2.85V
RP171N291B	JAW	2.9V

Product Name	①② ③	Volta ge
RP171N301B	JAX	3.0V
RP171N311B	JAY	3.1V
RP171N321B	JAZ	3.2V
RP171N331B	KAA	3.3V
RP171N341B	KAB	3.4V
RP171N351B	KAC	3.5V
RP171N361B	KAD	3.6V
RP171N371B	KAE	3.7V
RP171N381B	KAF	3.8V
RP171N391B	KAG	3.9V
RP171N401B	KAH	4.0V
RP171N411B	KAJ	4.1V
RP171N421B	KAK	4.2V
RP171N431B	KAL	4.3V
RP171N441B	KAM	4.4V
RP171N451B	KAN	4.5V
RP171N461B	KAP	4.6V
RP171N471B	KAQ	4.7V
RP171N481B	KAR	4.8V
RP171N491B	KAS	4.9V

Product Name	①② ③	Volta ge
RP171N501B	KAT	5.0V
RP171N511B	KAU	5.1V
RP171N521B	KAV	5.2V
RP171N531B	KAW	5.3V
RP171N541B	KAX	5.4V
RP171N551B	KAY	5.5V
RP171N561B	KAZ	5.6V
RP171N571B	LAA	5.7V
RP171N581B	LAB	5.8V
RP171N591B	LAC	5.9V
RP171N601B	LAD	6.0V

RP171Nxx1D

Product Name	①② ③	Volta ge
RP171N121D	JBA	1.2V
RP171N121D5	JBB	1.25V
RP171N131D	JBC	1.3V
RP171N141D	JBD	1.4V
RP171N151D	JBE	1.5V
RP171N161D	JBF	1.6V
RP171N171D	JBG	1.7V
RP171N181D	JBH	1.8V
RP171N181D5	JBJ	1.85V
RP171N191D	JBK	1.9V
RP171N201D	JBL	2.0V
RP171N211D	JBM	2.1V
RP171N221D	JBN	2.2V
RP171N231D	JBP	2.3V
RP171N241D	JBQ	2.4V
RP171N251D	JBR	2.5V
RP171N261D	JBS	2.6V
RP171N271D	JBT	2.7V
RP171N281D	JBU	2.8V
RP171N281D5	JBV	2.85V
RP171N291D	JBW	2.9V

Product Name	①② ③	Volta ge
RP171N301D	JBX	3.0V
RP171N311D	JBZ	3.1V
RP171N321D	JBZ	3.2V
RP171N331D	KBA	3.3V
RP171N341D	KBB	3.4V
RP171N351D	KBC	3.5V
RP171N361D	KBD	3.6V
RP171N371D	KBE	3.7V
RP171N381D	KBF	3.8V
RP171N391D	KBG	3.9V
RP171N401D	KBH	4.0V
RP171N411D	KBJ	4.1V
RP171N421D	KBK	4.2V
RP171N431D	KBL	4.3V
RP171N441D	KBM	4.4V
RP171N451D	KBN	4.5V
RP171N461D	KBP	4.6V
RP171N471D	KBQ	4.7V
RP171N481D	KBR	4.8V
RP171N491D	KBS	4.9V

Product Name	①② ③	Volta ge
RP171N501D	KBT	5.0V
RP171N511D	KBU	5.1V
RP171N521D	KBV	5.2V
RP171N531D	KBW	5.3V
RP171N541D	KBX	5.4V
RP171N551D	KBY	5.5V
RP171N561D	KBZ	5.6V
RP171N571D	LBA	5.7V
RP171N581D	LBB	5.8V
RP171N591D	LBC	5.9V
RP171N601D	LBD	6.0V

TEST CIRCUITS



Basic Test Circuit



Test Circuit for Supply Current



Test Circuit for Ripple Rejection



Test Circuit for Load Transient Response

TYPICAL CHARACTERISTICS

1) Output Voltage vs. Output Current (T_{opt}=25°C)



2) Output Voltage vs. Input Voltage (T_{opt}=25°C)

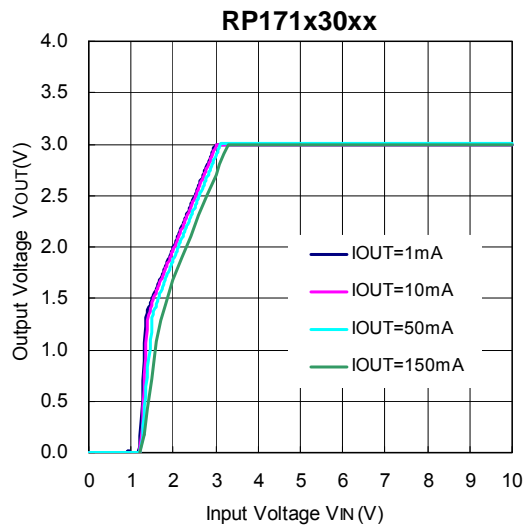



3) Supply Current vs. Input Voltage ($T_{opt}=25^{\circ}C$)

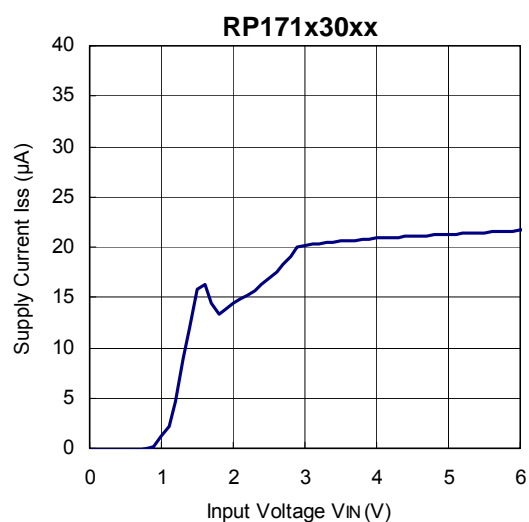
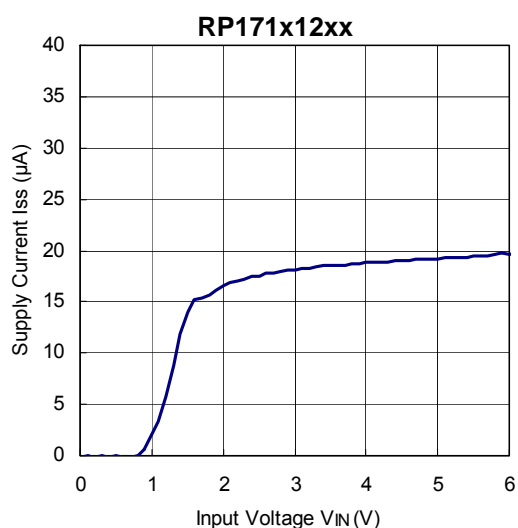

RP171x

NO.EA-245-160324

4) Supply Current vs. Output Current (T_{opt}=25°C)



5) Output Voltage vs. Temperature

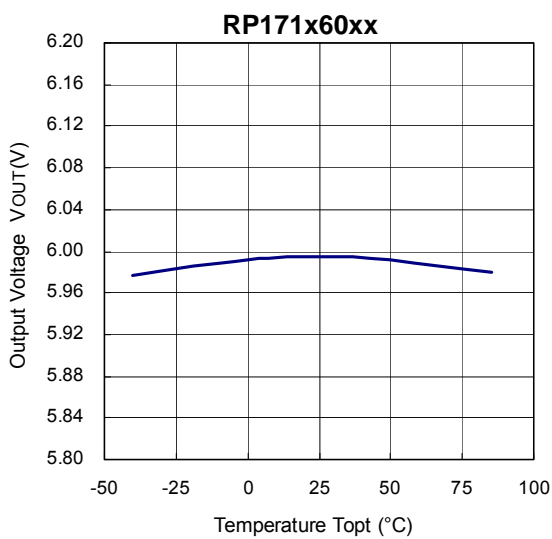
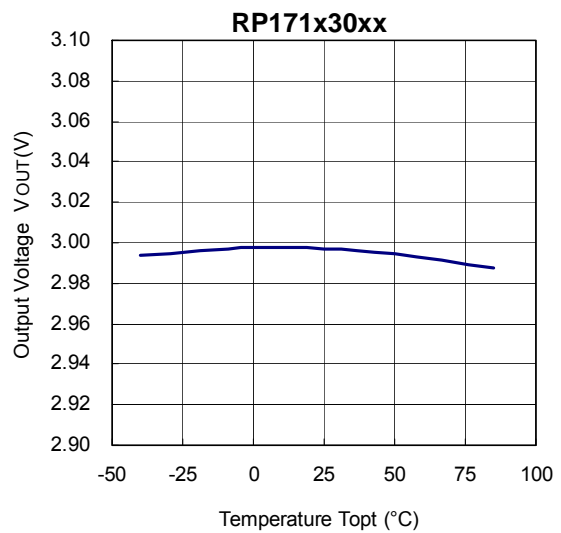
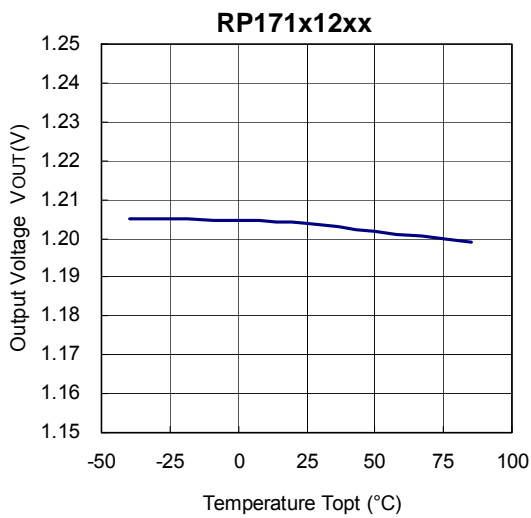

6) Supply Current vs. Temperature



7) Dropout Voltage vs. Output Current



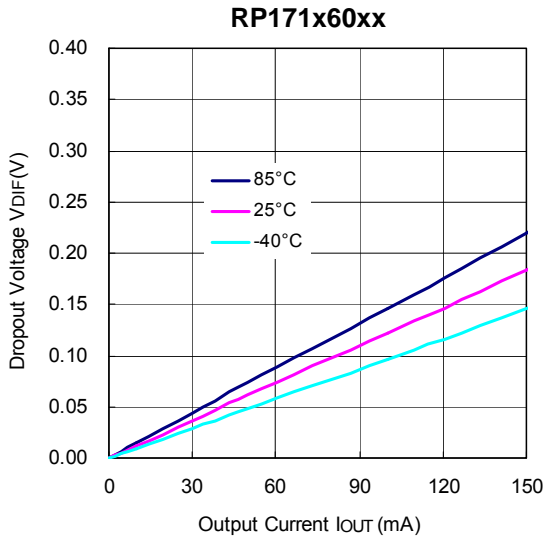

8) Dropout Voltage vs. Set Output Voltage (T_{opt}=25°C)

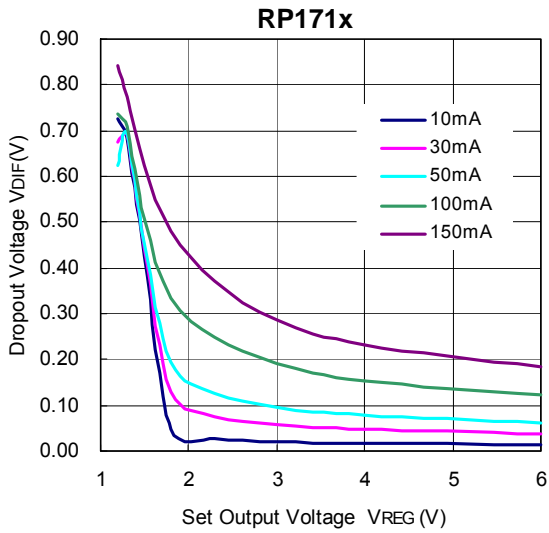

9) Minimum Operating Voltage

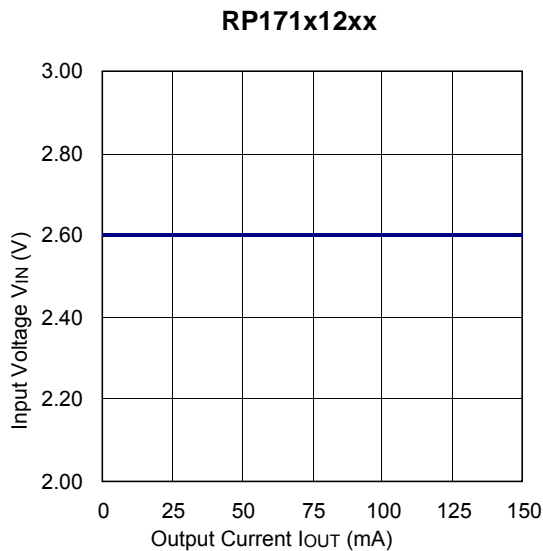

10) Ripple Rejection vs. Input Bias Voltage (C1=none, C2=Ceramic 1.0μF, Ripple=0.2Vp-p, T_{opt}=25°C)

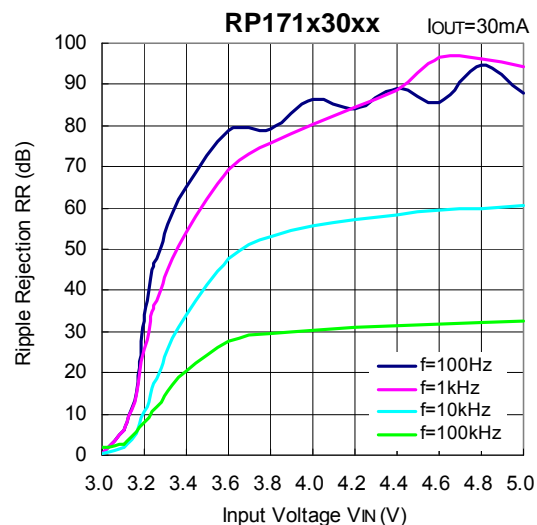

11) Ripple Rejection vs. Frequency (C1=none, C2=Ceramic 1.0μF, T_{opt}=25°C)

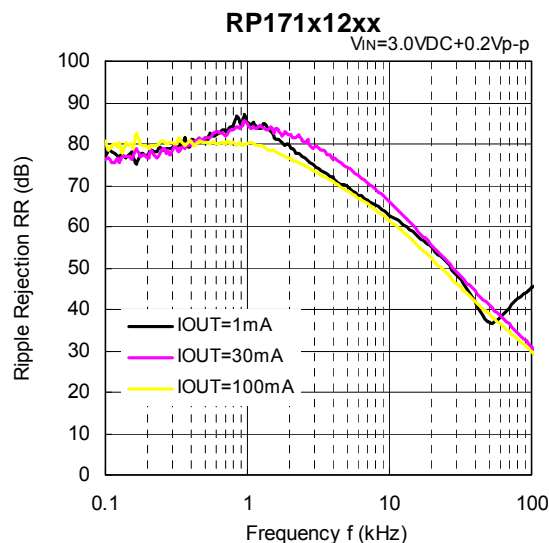

RP171x

NO.EA-245-160324

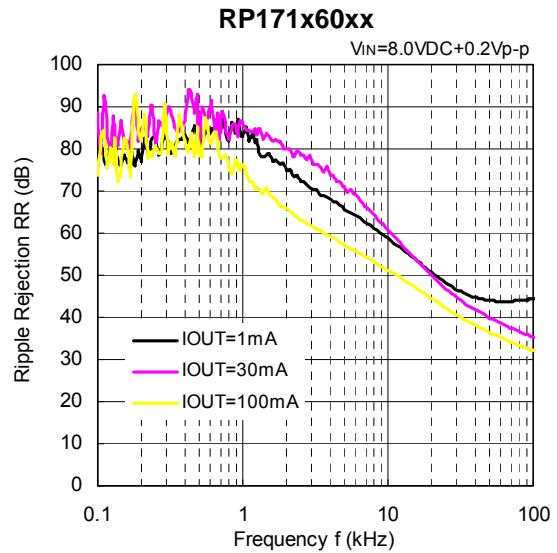
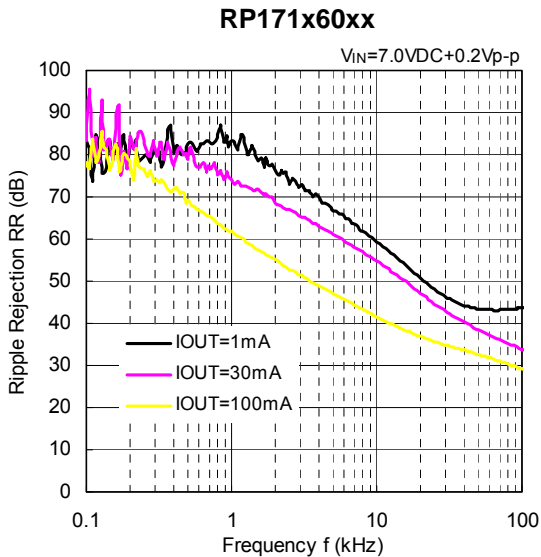
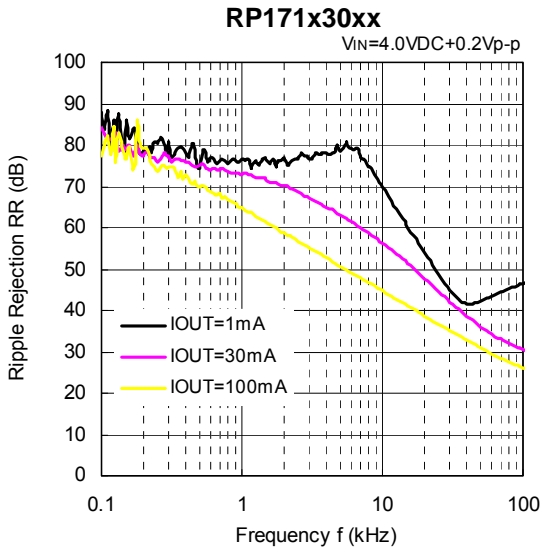

12) Input Transient Response (C1=none, IOUT=30mA, tr=tf=5μs, Topt=25°C)



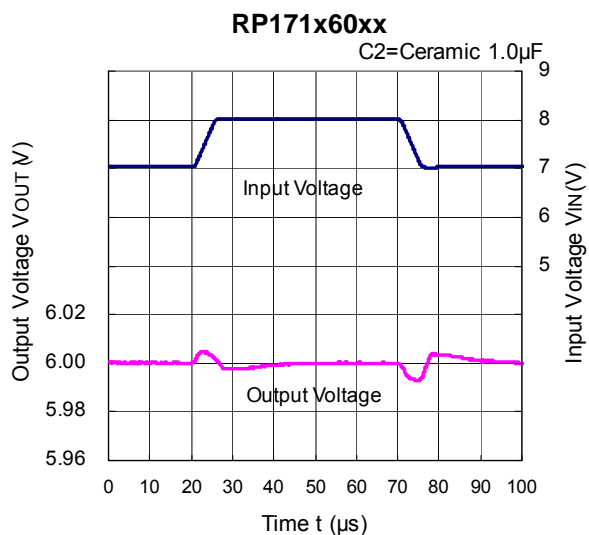

13) Load Transient Response (C1=Ceramic 1.0 μ F, $t_r=t_f=500ns$, $T_{opt}=25^{\circ}C$)



RP171x12xx



RP171x30xx

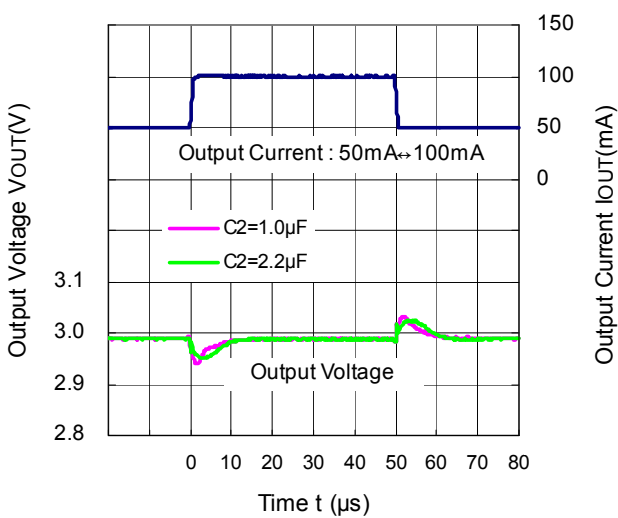

RP171x30xx



RP171x30xx

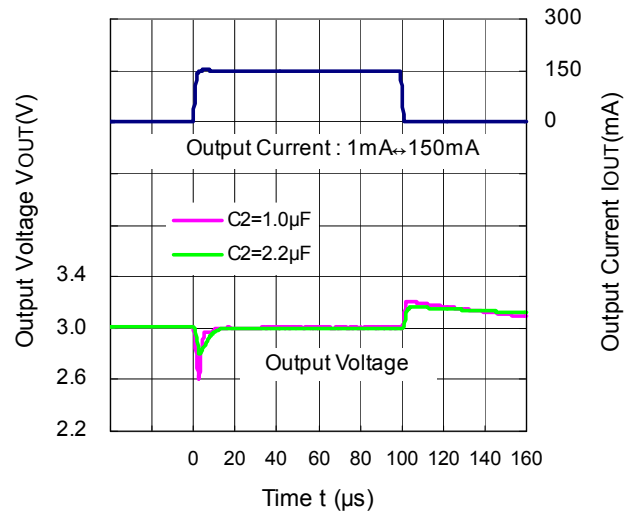



RP171x

NO.EA-245-160324

14) Turn On Speed with CE pin (C1=Ceramic 1.0μF, T_{opt}=25°C)

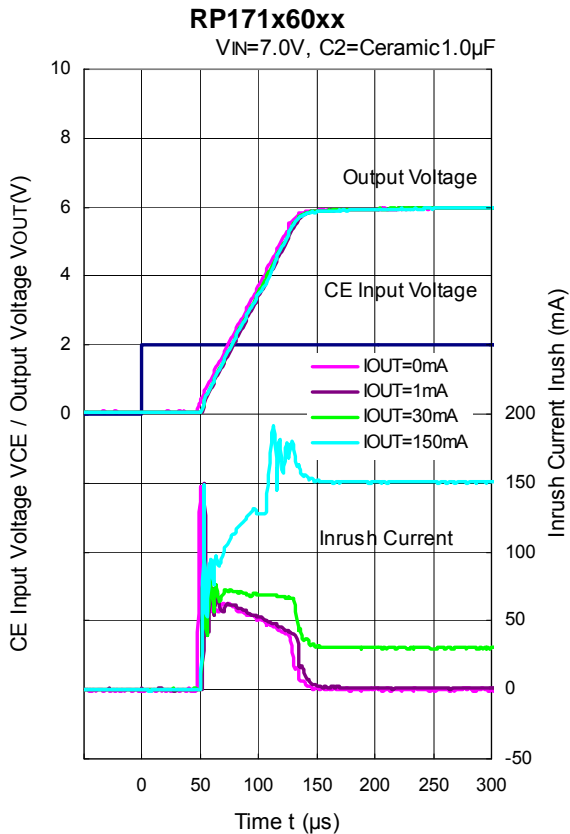
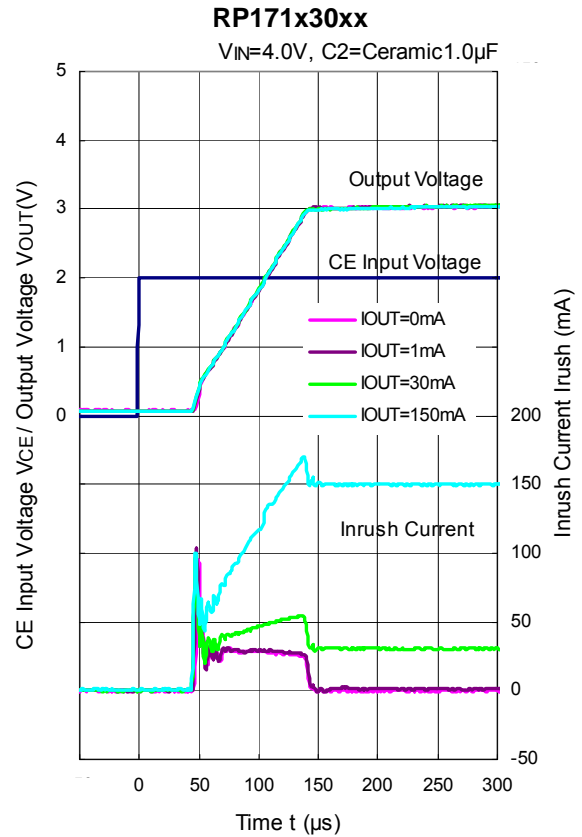
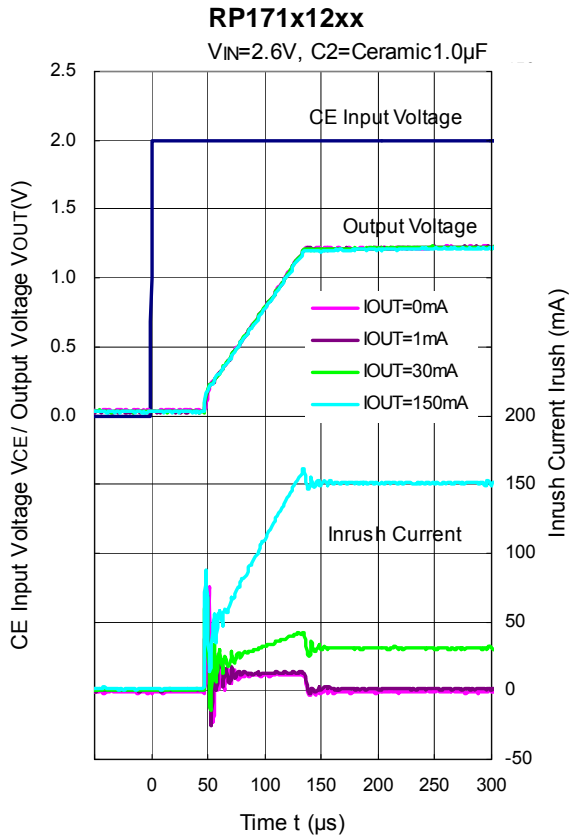

RP171x12xx

$V_{IN}=2.6V, I_{OUT}=1mA$



RP171x30xx

$V_{IN}=4.0V, I_{OUT}=1mA$



RP171x60xx

$V_{IN}=7.0V, I_{OUT}=1mA$

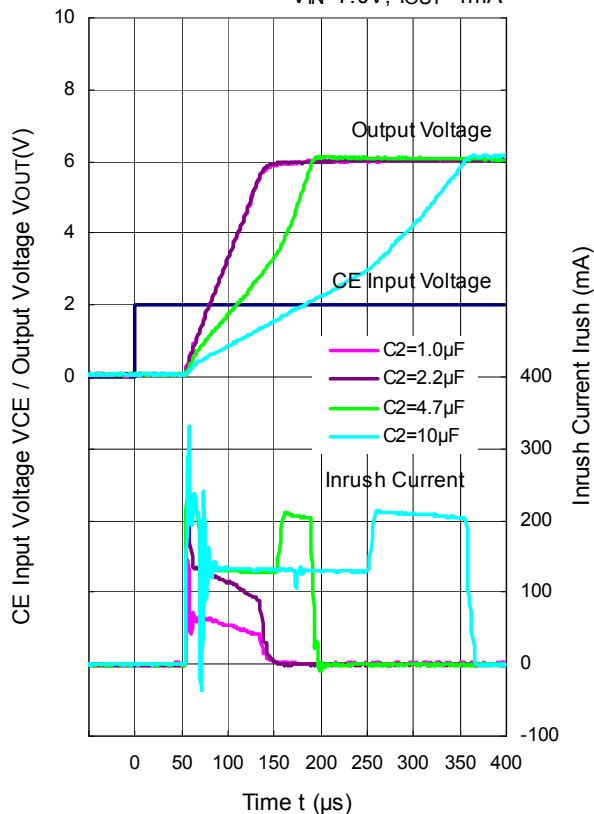

RP171x

NO.EA-245-160324

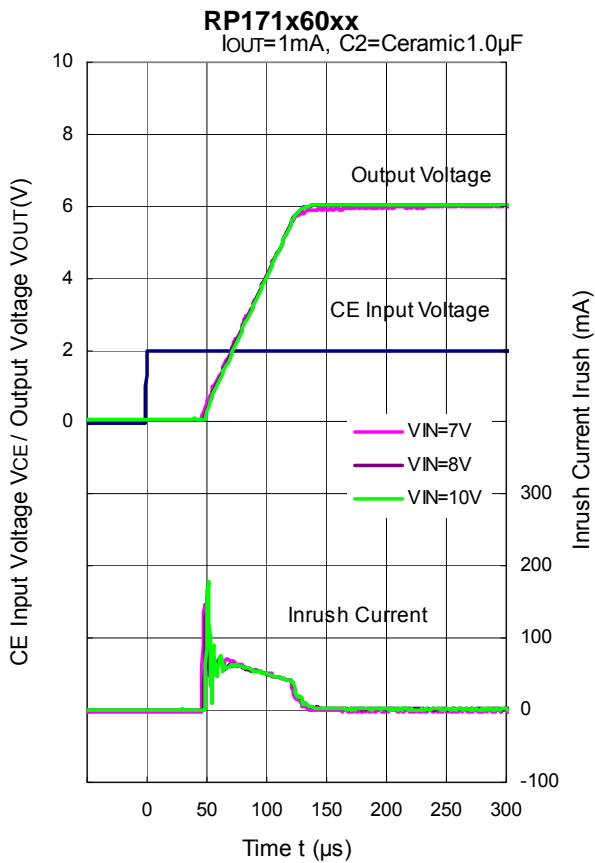
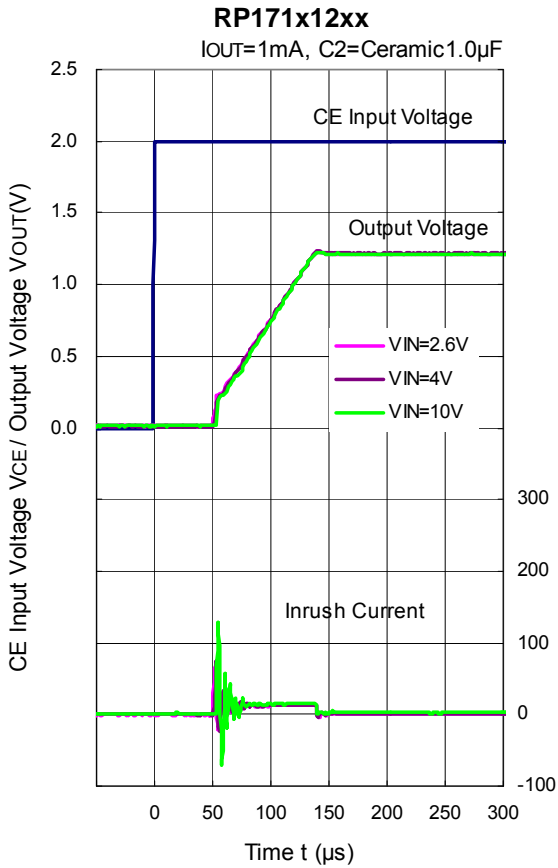

15) Turn Off Speed with CE pin (D Version) (C1=Ceramic 1.0μF, T_{opt}=25°C)

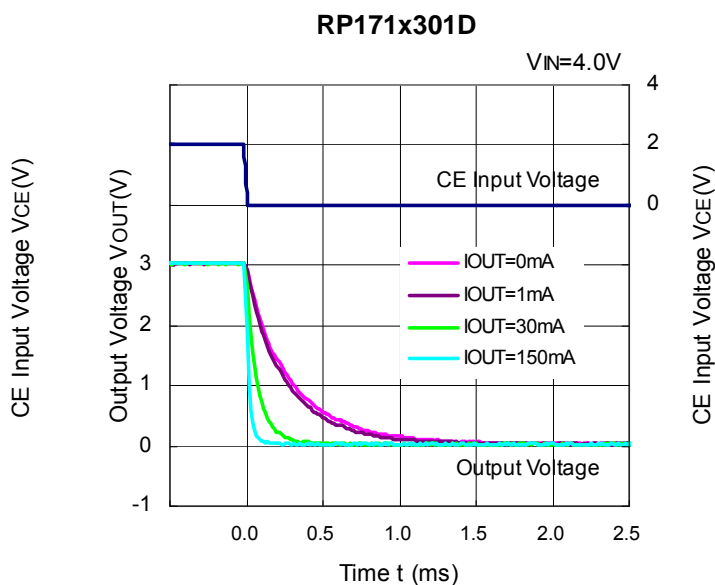
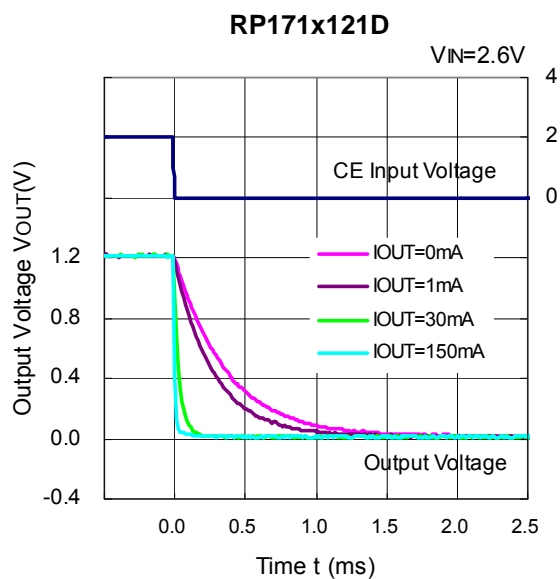

ESR vs. Output Current

When using these ICs, consider the following points:

The relations between I_{OUT} (Output Current) and ESR of an output capacitor are shown below.

The conditions when the white noise level is under $40\mu\text{V}$ (Avg.) are marked as the hatched area in the graph.

Measurement conditions

Frequency Band : 10Hz to 2MHz

Temperature : -40°C to 85°C

C1, C2 : Ceramic $1.0\mu\text{F}$ (Murata GRM155B31A105KE)

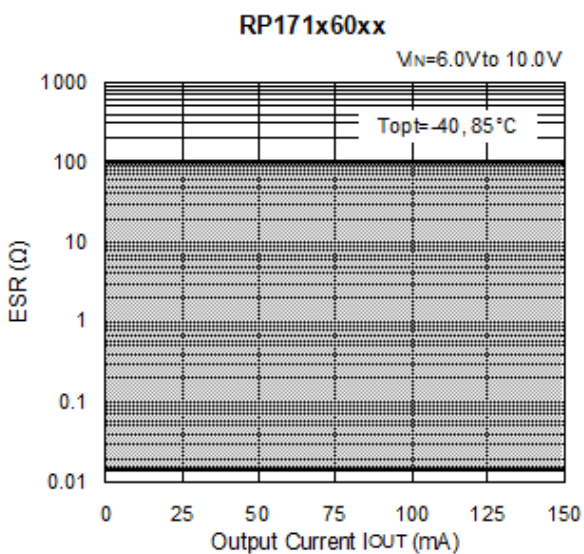



1. The products and the product specifications described in this document are subject to change or discontinuation of production without notice for reasons such as improvement. Therefore, before deciding to use the products, please refer to Ricoh sales representatives for the latest information thereon.
2. The materials in this document may not be copied or otherwise reproduced in whole or in part without prior written consent of Ricoh.
3. Please be sure to take any necessary formalities under relevant laws or regulations before exporting or otherwise taking out of your country the products or the technical information described herein.
4. The technical information described in this document shows typical characteristics of and example application circuits for the products. The release of such information is not to be construed as a warranty of or a grant of license under Ricoh's or any third party's intellectual property rights or any other rights.
5. The products listed in this document are intended and designed for use as general electronic components in standard applications (office equipment, telecommunication equipment, measuring instruments, consumer electronic products, amusement equipment etc.). Those customers intending to use a product in an application requiring extreme quality and reliability, for example, in a highly specific application where the failure or misoperation of the product could result in human injury or death (aircraft, spacevehicle, nuclear reactor control system, traffic control system, automotive and transportation equipment, combustion equipment, safety devices, life support system etc.) should first contact us.
6. We are making our continuous effort to improve the quality and reliability of our products, but semiconductor products are likely to fail with certain probability. In order to prevent any injury to persons or damages to property resulting from such failure, customers should be careful enough to incorporate safety measures in their design, such as redundancy feature, fire containment feature and fail-safe feature. We do not assume any liability or responsibility for any loss or damage arising from misuse or inappropriate use of the products.
7. Anti-radiation design is not implemented in the products described in this document.
8. Please contact Ricoh sales representatives should you have any questions or comments concerning the products or the technical information.



Ricoh is committed to reducing the environmental loading materials in electrical devices with a view to contributing to the protection of human health and the environment.

Ricoh has been providing RoHS compliant products since April 1, 2006 and Halogen-free products since April 1, 2012.

RICOH RICOH ELECTRONIC DEVICES CO., LTD.

<http://www.e-devices.ricoh.co.jp/en/>

Sales & Support Offices

RICOH ELECTRONIC DEVICES CO., LTD.

Higashi-Shinagawa Office (International Sales)
3-32-3, Higashi-Shinagawa, Shinagawa-ku, Tokyo 140-8655, Japan
Phone: +81-3-5479-2857 Fax: +81-3-5479-0502

RICOH EUROPE (NETHERLANDS) B.V.

Semiconductor Support Centre
Prof. W.H. Keesomlaan 1, 1183 DJ Amstelveen, The Netherlands
Phone: +31-20-5474-309

RICOH INTERNATIONAL B.V. - German Branch

Semiconductor Sales and Support Centre
Oberrather Strasse 6, 40472 Düsseldorf, Germany
Phone: +49-211-6546-0

RICOH ELECTRONIC DEVICES KOREA CO., LTD.

3F, Haesung Bldg, 504, Teheran-ro, Gangnam-gu, Seoul, 135-725, Korea
Phone: +82-2-2135-5700 Fax: +82-2-2051-5713

RICOH ELECTRONIC DEVICES SHANGHAI CO., LTD.

Room 403, No.2 Building, No.690 Bibo Road, Pu Dong New District, Shanghai 201203, People's Republic of China
Phone: +86-21-5027-3200 Fax: +86-21-5027-3299

RICOH ELECTRONIC DEVICES CO., LTD.

Taipei office
Room 109, 10F-1, No.51, Hengyang Rd., Taipei City, Taiwan (R.O.C.)
Phone: +886-2-2313-1621/1622 Fax: +886-2-2313-1623

Mouser Electronics

Authorized Distributor

Click to View Pricing, Inventory, Delivery & Lifecycle Information:

Ricoh Electronics:

[RP171N251B-TR-FE](#) [RP171N181B-TR-FE](#) [RP171N281D-TR-FE](#) [RP171N331B-TR-FE](#) [RP171N301D-TR-FE](#)
[RP171N601B-TR-FE](#) [RP171N501D-TR-FE](#) [RP171N151B-TR-FE](#) [RP171N121B-TR-FE](#) [RP171N301B-TR-FE](#)
[RP171N331D-TR-FE](#) [RP171N281B-TR-FE](#) [RP171N501B-TR-FE](#)

Компания «Океан Электроники» предлагает заключение долгосрочных отношений при поставках импортных электронных компонентов на взаимовыгодных условиях!

Наши преимущества:

- Поставка оригинальных импортных электронных компонентов напрямую с производств Америки, Европы и Азии, а так же с крупнейших складов мира;
- Широкая линейка поставок активных и пассивных импортных электронных компонентов (более 30 млн. наименований);
- Поставка сложных, дефицитных, либо снятых с производства позиций;
- Оперативные сроки поставки под заказ (от 5 рабочих дней);
- Экспресс доставка в любую точку России;
- Помощь Конструкторского Отдела и консультации квалифицированных инженеров;
- Техническая поддержка проекта, помощь в подборе аналогов, поставка прототипов;
- Поставка электронных компонентов под контролем ВП;
- Система менеджмента качества сертифицирована по Международному стандарту ISO 9001;
- При необходимости вся продукция военного и аэрокосмического назначения проходит испытания и сертификацию в лаборатории (по согласованию с заказчиком);
- Поставка специализированных компонентов военного и аэрокосмического уровня качества (Xilinx, Altera, Analog Devices, Intersil, Interpoint, Microsemi, Actel, Aeroflex, Peregrine, VPT, Syfer, Eurofarad, Texas Instruments, MS Kennedy, Miteq, Cobham, E2V, MA-COM, Hittite, Mini-Circuits, General Dynamics и др.);

Компания «Океан Электроники» является официальным дистрибьютором и эксклюзивным представителем в России одного из крупнейших производителей разъемов военного и аэрокосмического назначения «JONHON», а так же официальным дистрибьютором и эксклюзивным представителем в России производителя высокотехнологичных и надежных решений для передачи СВЧ сигналов «FORSTAR».



JONHON

«JONHON» (основан в 1970 г.)

Разъемы специального, военного и аэрокосмического назначения:

(Применяются в военной, авиационной, аэрокосмической, морской, железнодорожной, горно- и нефтедобывающей отраслях промышленности)

«FORSTAR» (основан в 1998 г.)

ВЧ соединители, коаксиальные кабели, кабельные сборки и микроволновые компоненты:

(Применяются в телекоммуникациях гражданского и специального назначения, в средствах связи, РЛС, а так же военной, авиационной и аэрокосмической отраслях промышленности).



Телефон: 8 (812) 309-75-97 (многоканальный)

Факс: 8 (812) 320-03-32

Электронная почта: ocean@oceanchips.ru

Web: <http://oceanchips.ru/>

Адрес: 198099, г. Санкт-Петербург, ул. Калинина, д. 2, корп. 4, лит. А