

---

## 150mA 10V INPUT LDO REGULATOR

---

NO.EA-245-160324

### OUTLINE

The RP171x Series are CMOS-based LDO regulators featuring 150mA output current. Because of the 10V maximum input voltage, RP171x can be used in 2 cell lithium-ion battery powered portable appliances and besides a portable equipment. The supply current is Typ. 23 $\mu$ A though an excellent response characteristics.

The output voltage range from 1.2V is possible. The output voltage accuracy and temperature-drift coefficient of output voltage of the RP171x Series are excellent.

RP171x has a fold-back protection circuit and a thermal shutdown circuit. Moreover, a standby mode with ultra low supply current can be realized with the chip enable function.

SC-88A and SOT-23-5 with high power dissipation packages are available.

### FEATURES

- Supply Current ..... Typ. 23 $\mu$ A
- Standby Mode ..... Typ. 0.1 $\mu$ A
- Dropout Voltage..... Typ. 0.20V ( $I_{OUT}=100\text{mA}$ ,  $V_{OUT}=3.0\text{V}$ )  
Typ. 0.40V ( $I_{OUT}=150\text{mA}$ ,  $V_{OUT}=2.8\text{V}$ )
- Ripple Rejection ..... Typ. 70dB ( $f=1\text{kHz}$ )
- Temperature-Drift Coefficient of Output Voltage ..... Typ.  $\pm 80\text{ppm}/^\circ\text{C}$
- Line Regulation ..... Typ. 0.02%/V
- Output Voltage Accuracy .....  $\pm 1.0\%$
- Packages..... SC-88A, SOT-23-5
- Input Voltage Range ..... 2.6V to 10.0V
- Output Voltage Range ..... 1.2V to 6.0V (0.1V steps)  
(For other voltages, please refer to MARK INFORMATIONS.)
- Built-in Fold Back Protection Circuit..... Typ. 40mA (Current at short mode)
- Built-in Thermal Shutdown Circuit..... Shutdown Temperature at 165 $^\circ\text{C}$
- Built-in Constant Slope Circuit (Soft-start Function)
- Ceramic capacitors are recommended to be used with this IC .... 1.0 $\mu$ F or more

### APPLICATIONS

- Power source for portable communication equipment.
- Power source for electrical appliances such as cameras, VCRs and camcorders.
- Power source for battery-powered equipment.
- Power source for home appliances.

# RP171x

NO.EA-245-160324

## BLOCK DIAGRAMS



## SELECTION GUIDE

The output voltage, auto discharge function, and package, etc. for the ICs can be selected at the user's request.

Product Name	Package	Quantity per Reel	Pb Free	Halogen Free
RP171Qxx2*-TR-FE	SC-88A	3,000 pcs	Yes	Yes
RP171Nxx1*-TR-FE	SOT-23-5	3,000 pcs	Yes	Yes

xx: The output voltage can be designated in the range from 1.2V(12) to 6.0V(60) in 0.1V steps.  
(For other voltages, please refer to MARK INFORMATIONS.)

\* : The auto discharge function at off state are options as follows.  
(B) without auto discharge function at off state  
(D) with auto discharge function at off state

## PIN CONFIGURATIONS



## PIN DESCRIPTIONS

### • SC-88A

Pin No	Symbol	Pin Description
1	CE	Chip Enable Pin ("H" Active)
2	NC	No Connection
3	GND	Ground Pin
4	V <sub>OUT</sub>	Output Pin
5	V <sub>DD</sub>	Input Pin

### • SOT-23-5

Pin No	Symbol	Pin Description
1	V <sub>DD</sub>	Input Pin
2	GND	Ground Pin
3	CE	Chip Enable Pin ("H" Active)
4	NC	No Connection
5	V <sub>OUT</sub>	Output Pin

## ABSOLUTE MAXIMUM RATINGS

Symbol	Item	Rating	Unit
$V_{IN}$	Input Voltage	12	V
$V_{CE}$	Input Voltage (CE Pin)	12	V
$V_{OUT}$	Output Voltage	-0.3 to $V_{IN}+0.3$	V
$I_{OUT}$	Output Current	330	mA
$P_D$	Power Dissipation* (SC-88A)	380	mW
	Power Dissipation* (SOT-23-5)	420	
$T_{opt}$	Operating Temperature Range	-40 to 85	°C
$T_{stg}$	Storage Temperature Range	-55 to 125	°C

\*) For Power Dissipation, please refer to PACKAGE INFORMATION.

### ABSOLUTE MAXIMUM RATINGS

Electronic and mechanical stress momentarily exceeded absolute maximum ratings may cause the permanent damages and may degrade the life time and safety for both device and system using the device in the field.

The functional operation at or over these absolute maximum ratings is not assured.

### RECOMMENDED OPERATING CONDITIONS (ELECTRICAL CHARACTERISTICS)

All of electronic equipment should be designed that the mounted semiconductor devices operate within the recommended operating conditions. The semiconductor devices cannot operate normally over the recommended operating conditions, even if when they are used over such conditions by momentary electronic noise or surge. And the semiconductor devices may receive serious damage when they continue to operate over the recommended operating conditions.

## ELECTRICAL CHARACTERISTICS

V<sub>IN</sub>=Set V<sub>OUT</sub>+1V, I<sub>OUT</sub>=1mA, unless otherwise noted.

The specifications in   are guaranteed by Design Engineering at -40°C ≤ T<sub>a</sub> ≤ 85°C.

### RP171xxxxB/D

T<sub>opt</sub>=25°C

Symbol	Item	Conditions	Min.	Typ.	Max.	Unit	
V <sub>OUT</sub>	Output Voltage	T <sub>opt</sub> =25°C	V <sub>OUT</sub> > 1.5V	×0.99		×1.01	V
			V <sub>OUT</sub> ≤ 1.5V	-15		+15	mV
		-40°C ≤ T <sub>opt</sub> ≤ 85°C	V <sub>OUT</sub> > 1.5V	×0.974		×1.023	V
			V <sub>OUT</sub> ≤ 1.5V	-40		+35	mV
I <sub>OUT</sub>	Output Current		150			mA	
ΔV <sub>OUT</sub> /ΔI <sub>OUT</sub>	Load Regulation	0.1mA ≤ I <sub>OUT</sub> ≤ 150mA		5	40	mV	
V <sub>DIF</sub>	Dropout Voltage	I <sub>OUT</sub> =150mA	1.2V ≤ V <sub>OUT</sub> < 1.3V		-	1.400	V
			1.3V ≤ V <sub>OUT</sub> < 1.5V		-	1.300	
			1.5V ≤ V <sub>OUT</sub> < 1.8V		-	1.100	
			1.8V ≤ V <sub>OUT</sub> < 2.3V		-	0.800	
			2.3V ≤ V <sub>OUT</sub> < 3.0V		0.400	0.580	
			3.0V ≤ V <sub>OUT</sub> < 4.0V		0.300	0.480	
			4.0V ≤ V <sub>OUT</sub> ≤ 6.0V		0.250	0.400	
I <sub>SS</sub>	Supply Current	I <sub>OUT</sub> =0mA		23	40	μA	
I <sub>standby</sub>	Standby Current	V <sub>IN</sub> =10.0V, V <sub>CE</sub> =GND		0.1	1.0	μA	
ΔV <sub>OUT</sub> /ΔV <sub>IN</sub>	Line Regulation	Set V <sub>OUT</sub> +0.5V ≤ V <sub>IN</sub> ≤ 10.0V (In case that V <sub>OUT</sub> ≤ 2.1V, 2.6V ≤ V <sub>IN</sub> ≤ 10.0V)		±0.02	±0.2	%/V	
RR	Ripple Rejection	f=1kHz, Ripple 0.2Vp-p, I <sub>OUT</sub> =30mA (In case that V <sub>OUT</sub> < 2.0V, V <sub>IN</sub> =3.0V)		70		dB	
V <sub>IN</sub>	Input Voltage		2.6		10	V	
ΔV <sub>OUT</sub> /ΔT <sub>opt</sub>	Output Voltage Temperature Coefficient	-40°C ≤ T <sub>opt</sub> ≤ 85°C		±80		ppm/°C	
I <sub>SC</sub>	Short Current Limit	V <sub>OUT</sub> =0V		40		mA	
I <sub>PD</sub>	CE Pull-down Current			0.30		μA	
V <sub>CEH</sub>	CE Input Voltage "H"		1.7			V	
V <sub>CEL</sub>	CE Input Voltage "L"				0.8	V	
T <sub>TSD</sub>	Thermal Shutdown Temperature	Junction Temperature		165		°C	
T <sub>TSR</sub>	Thermal Shutdown Released Temperature	Junction Temperature		110		°C	
en	Output Noise	BW=10Hz to 100kHz		100		μVrms	
R <sub>LOW</sub>	Low Output Nch Tr. ON Resistance (of D version)	V <sub>IN</sub> =7.0V V <sub>CE</sub> =0V		250		Ω	

All of unit are tested and specified under load conditions such that T<sub>j</sub>≈T<sub>opt</sub>=25°C except for Output Noise, Ripple Rejection, Output Voltage Temperature Coefficient and Thermal Shutdown.

## TYPICAL APPLICATION



(External Components)

C2 1.0 $\mu$ F MURATA: GRM155B31A105KE15

## TECHNICAL NOTES

When using these ICs, consider the following points:

### Phase Compensation

In these ICs, phase compensation is made for securing stable operation even if the load current is varied. For this purpose, use a capacitor C2 with 1.0 $\mu$ F or more and good ESR (Equivalent Series Resistance).

(Note: If additional ceramic capacitors are connected with parallel to the output pin with an output capacitor for phase compensation, the operation might be unstable. Because of this, test these ICs with as same external components as ones to be used on the PCB.)

### PCB Layout

Make  $V_{DD}$  and GND lines sufficient. If their impedance is high, noise pickup or unstable operation may result. Connect a capacitor C1 with a capacitance value as much as 1.0 $\mu$ F or more between  $V_{DD}$  and GND pin, and as close as possible to the pins.

Set external components, especially the output capacitor C2, as close as possible to the ICs, and make wiring as short as possible.

## PACKAGE INFORMATION

### • Power Dissipation (SC-88A)

Power Dissipation ( $P_D$ ) depends on conditions of mounting on board. This specification is based on the measurement at the condition below:

#### Measurement Conditions:

	Standard Land Pattern
Environment	Mounting on Board (Wind velocity=0m/s)
Board Material	Glass cloth epoxy plastic (Double Layers)
Board Dimensions	40mm × 40mm × 1.6mm
Copper Ratio	Top side: Approx. 50%, Back side: Approx. 50%
Through-hole	φ0.5mm × 44pcs

#### Measurement Results:

( $T_a=25^{\circ}\text{C}$ )

	Standard Land Pattern	Free Air
Power Dissipation	380mW ( $T_{j\text{max}}=125^{\circ}\text{C}$ ) 475mW ( $T_{j\text{max}}=150^{\circ}\text{C}$ )	150mW
Thermal Resistance	$\theta_{ja}=(125-25^{\circ}\text{C})/0.38\text{W}=263^{\circ}\text{C/W}$	$\theta_{ja}=(125-25^{\circ}\text{C})/0.15\text{W}=667^{\circ}\text{C/W}$
	$\theta_{jc}=75^{\circ}\text{C/W}$	-



Measurement Board Pattern

⊙ IC Mount Area (Unit: mm)

#### Power Dissipation

The above graph shows the Power Dissipation of the package under the conditions of  $T_{j\text{max}}=125^{\circ}\text{C}$  and  $T_{j\text{max}}=150^{\circ}\text{C}$ .

The operation of the IC within the shaded range in the graph might have an affect on the IC's lifetime. The operation time of the IC must be remained within the time limit described in the table below.

Operating Time	Estimated Years (Operating 4 hours/day)
13,000 hours	9 years

• Package Dimensions (SC-88A)

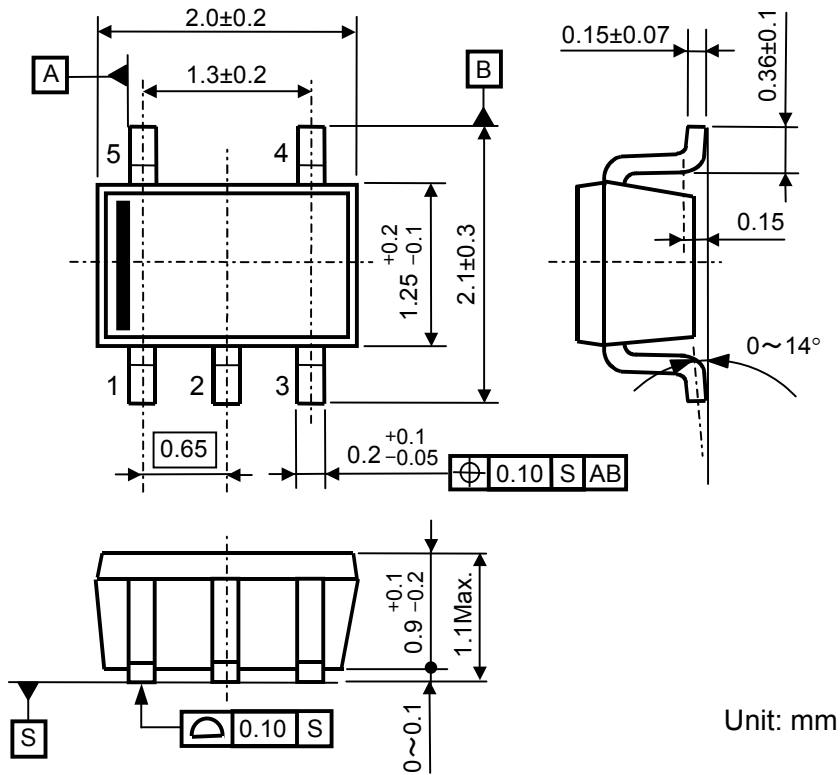

• Mark Specification (SC-88A)

①②③④: Product Code ... Refer to "Mark Specification Table".

⑤⑥: Lot Number ... Alphanumeric Serial Number

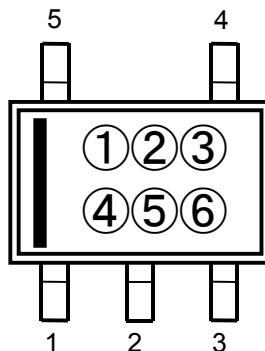



● RP171Q Series Mark Specification Table (SC-88A)

RP171Qxx2B

Product Name	①② ③④	Volta ge
RP171Q122B	<b>AC01</b>	1.2V
RP171Q122B5	<b>AC02</b>	1.25V
RP171Q132B	<b>AC03</b>	1.3V
RP171Q142B	<b>AC04</b>	1.4V
RP171Q152B	<b>AC05</b>	1.5V
RP171Q162B	<b>AC06</b>	1.6V
RP171Q172B	<b>AC07</b>	1.7V
RP171Q182B	<b>AC08</b>	1.8V
RP171Q182B5	<b>AC09</b>	1.85V
RP171Q192B	<b>AC10</b>	1.9V
RP171Q202B	<b>AC11</b>	2.0V
RP171Q212B	<b>AC12</b>	2.1V
RP171Q222B	<b>AC13</b>	2.2V
RP171Q232B	<b>AC14</b>	2.3V
RP171Q242B	<b>AC15</b>	2.4V
RP171Q252B	<b>AC16</b>	2.5V
RP171Q262B	<b>AC17</b>	2.6V
RP171Q272B	<b>AC18</b>	2.7V
RP171Q282B	<b>AC19</b>	2.8V
RP171Q282B5	<b>AC20</b>	2.85V
RP171Q292B	<b>AC21</b>	2.9V

Product Name	①② ③④	Volta ge
RP171Q302B	<b>AC22</b>	3.0V
RP171Q312B	<b>AC23</b>	3.1V
RP171Q322B	<b>AC24</b>	3.2V
RP171Q332B	<b>AC25</b>	3.3V
RP171Q342B	<b>AC26</b>	3.4V
RP171Q352B	<b>AC27</b>	3.5V
RP171Q362B	<b>AC28</b>	3.6V
RP171Q372B	<b>AC29</b>	3.7V
RP171Q382B	<b>AC30</b>	3.8V
RP171Q392B	<b>AC31</b>	3.9V
RP171Q402B	<b>AC32</b>	4.0V
RP171Q412B	<b>AC33</b>	4.1V
RP171Q422B	<b>AC34</b>	4.2V
RP171Q432B	<b>AC35</b>	4.3V
RP171Q442B	<b>AC36</b>	4.4V
RP171Q452B	<b>AC37</b>	4.5V
RP171Q462B	<b>AC38</b>	4.6V
RP171Q472B	<b>AC39</b>	4.7V
RP171Q482B	<b>AC40</b>	4.8V
RP171Q492B	<b>AC41</b>	4.9V

Product Name	①② ③④	Volta ge
RP171Q502B	<b>AC42</b>	5.0V
RP171Q512B	<b>AC43</b>	5.1V
RP171Q522B	<b>AC44</b>	5.2V
RP171Q532B	<b>AC45</b>	5.3V
RP171Q542B	<b>AC46</b>	5.4V
RP171Q552B	<b>AC47</b>	5.5V
RP171Q562B	<b>AC48</b>	5.6V
RP171Q572B	<b>AC49</b>	5.7V
RP171Q582B	<b>AC50</b>	5.8V
RP171Q592B	<b>AC51</b>	5.9V
RP171Q602B	<b>AC52</b>	6.0V

RP171Qxx2D

Product Name	①② ③④	Volta ge
RP171Q122D	<b>AD01</b>	1.2V
RP171Q122D5	<b>AD02</b>	1.25V
RP171Q132D	<b>AD03</b>	1.3V
RP171Q142D	<b>AD04</b>	1.4V
RP171Q152D	<b>AD05</b>	1.5V
RP171Q162D	<b>AD06</b>	1.6V
RP171Q172D	<b>AD07</b>	1.7V
RP171Q182D	<b>AD08</b>	1.8V
RP171Q182D5	<b>AD09</b>	1.85V
RP171Q192D	<b>AD10</b>	1.9V
RP171Q202D	<b>AD11</b>	2.0V
RP171Q212D	<b>AD12</b>	2.1V
RP171Q222D	<b>AD13</b>	2.2V
RP171Q232D	<b>AD14</b>	2.3V
RP171Q242D	<b>AD15</b>	2.4V
RP171Q252D	<b>AD16</b>	2.5V
RP171Q262D	<b>AD17</b>	2.6V
RP171Q272D	<b>AD18</b>	2.7V
RP171Q282D	<b>AD19</b>	2.8V
RP171Q282D5	<b>AD20</b>	2.85V
RP171Q292D	<b>AD21</b>	2.9V

Product Name	①② ③④	Volta ge
RP171Q302D	<b>AD22</b>	3.0V
RP171Q312D	<b>AD23</b>	3.1V
RP171Q322D	<b>AD24</b>	3.2V
RP171Q332D	<b>AD25</b>	3.3V
RP171Q342D	<b>AD26</b>	3.4V
RP171Q352D	<b>AD27</b>	3.5V
RP171Q362D	<b>AD28</b>	3.6V
RP171Q372D	<b>AD29</b>	3.7V
RP171Q382D	<b>AD30</b>	3.8V
RP171Q392D	<b>AD31</b>	3.9V
RP171Q402D	<b>AD32</b>	4.0V
RP171Q412D	<b>AD33</b>	4.1V
RP171Q422D	<b>AD34</b>	4.2V
RP171Q432D	<b>AD35</b>	4.3V
RP171Q442D	<b>AD36</b>	4.4V
RP171Q452D	<b>AD37</b>	4.5V
RP171Q462D	<b>AD38</b>	4.6V
RP171Q472D	<b>AD39</b>	4.7V
RP171Q482D	<b>AD40</b>	4.8V
RP171Q492D	<b>AD41</b>	4.9V

Product Name	①② ③④	Volta ge
RP171Q502D	<b>AD42</b>	5.0V
RP171Q512D	<b>AD43</b>	5.1V
RP171Q522D	<b>AD44</b>	5.2V
RP171Q532D	<b>AD45</b>	5.3V
RP171Q542D	<b>AD46</b>	5.4V
RP171Q552D	<b>AD47</b>	5.5V
RP171Q562D	<b>AD48</b>	5.6V
RP171Q572D	<b>AD49</b>	5.7V
RP171Q582D	<b>AD50</b>	5.8V
RP171Q592D	<b>AD51</b>	5.9V
RP171Q602D	<b>AD52</b>	6.0V

## RP171x

NO.EA-245-160324

### • Power Dissipation (SOT-23-5)

Power Dissipation ( $P_D$ ) depends on conditions of mounting on board. This specification is based on the measurement at the condition below:

(Power Dissipation (SOT-23-5) is substitution of SOT-23-6.)

#### Measurement Conditions:

	Standard Land Pattern
Environment	Mounting on Board (Wind velocity=0m/s)
Board Material	Glass cloth epoxy plastic (Double sided)
Board Dimensions	40mm × 40mm × 1.6mm
Copper Ratio	Top side: Approx. 50%, Back side: Approx. 50%
Through-holes	φ 0.5mm × 44pcs

#### Measurement Results:

( $T_a=25^\circ\text{C}$ )

	Standard Land Pattern	Free Air
Power Dissipation	420mW ( $T_{j\max}=125^\circ\text{C}$ ) 525mW ( $T_{j\max}=150^\circ\text{C}$ )	250mW
Thermal Resistance	$\theta_{ja} = (125-25^\circ\text{C})/0.42\text{W} = 238^\circ\text{C/W}$	400 $^\circ\text{C/W}$



**Power Dissipation**



**Measurement Board Pattern**

○ IC Mount Area (Unit: mm)

The above graph shows the Power Dissipation of the package under the conditions of  $T_{j\max}=125^\circ\text{C}$  and  $T_{j\max}=150^\circ\text{C}$ .

The operation of the IC within the shaded range in the graph might have an affect on the IC's lifetime. The operation time of the IC must be remained within the time limit described in the table below.

Operating Time	Estimated Years (Operating 4 hours/day)
13,000 hours	9 years

• Package Dimensions (SOT-23-5)



• Mark Specification (SOT-23-5)

①②③: Product Code ...Refer to "Mark Specification Table".

④⑤: Lot Number ... Alphanumeric Serial Number

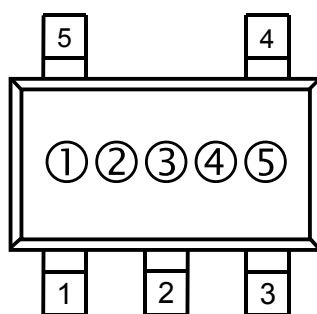

---

**RP171x**

---

NO.EA-245-160324

**• RP171N Series Mark Specification Table (SOT-23-5)****RP171Nxx1B**

Product Name	①② ③	Volta ge
RP171N121B	<b>JAA</b>	1.2V
RP171N121B5	<b>JAB</b>	1.25V
RP171N131B	<b>JAC</b>	1.3V
RP171N141B	<b>JAD</b>	1.4V
RP171N151B	<b>JAE</b>	1.5V
RP171N161B	<b>JAF</b>	1.6V
RP171N171B	<b>JAG</b>	1.7V
RP171N181B	<b>JAH</b>	1.8V
RP171N181B5	<b>JAJ</b>	1.85V
RP171N191B	<b>JAK</b>	1.9V
RP171N201B	<b>JAL</b>	2.0V
RP171N211B	<b>JAM</b>	2.1V
RP171N221B	<b>JAN</b>	2.2V
RP171N231B	<b>JAP</b>	2.3V
RP171N241B	<b>JAQ</b>	2.4V
RP171N251B	<b>JAR</b>	2.5V
RP171N261B	<b>JAS</b>	2.6V
RP171N271B	<b>JAT</b>	2.7V
RP171N281B	<b>JAU</b>	2.8V
RP171N281B5	<b>JAV</b>	2.85V
RP171N291B	<b>JAW</b>	2.9V

Product Name	①② ③	Volta ge
RP171N301B	<b>JAX</b>	3.0V
RP171N311B	<b>JAY</b>	3.1V
RP171N321B	<b>JAZ</b>	3.2V
RP171N331B	<b>KAA</b>	3.3V
RP171N341B	<b>KAB</b>	3.4V
RP171N351B	<b>KAC</b>	3.5V
RP171N361B	<b>KAD</b>	3.6V
RP171N371B	<b>KAE</b>	3.7V
RP171N381B	<b>KAF</b>	3.8V
RP171N391B	<b>KAG</b>	3.9V
RP171N401B	<b>KAH</b>	4.0V
RP171N411B	<b>KAJ</b>	4.1V
RP171N421B	<b>KAK</b>	4.2V
RP171N431B	<b>KAL</b>	4.3V
RP171N441B	<b>KAM</b>	4.4V
RP171N451B	<b>KAN</b>	4.5V
RP171N461B	<b>KAP</b>	4.6V
RP171N471B	<b>KAQ</b>	4.7V
RP171N481B	<b>KAR</b>	4.8V
RP171N491B	<b>KAS</b>	4.9V

Product Name	①② ③	Volta ge
RP171N501B	<b>KAT</b>	5.0V
RP171N511B	<b>KAU</b>	5.1V
RP171N521B	<b>KAV</b>	5.2V
RP171N531B	<b>KAW</b>	5.3V
RP171N541B	<b>KAX</b>	5.4V
RP171N551B	<b>KAY</b>	5.5V
RP171N561B	<b>KAZ</b>	5.6V
RP171N571B	<b>LAA</b>	5.7V
RP171N581B	<b>LAB</b>	5.8V
RP171N591B	<b>LAC</b>	5.9V
RP171N601B	<b>LAD</b>	6.0V

**RP171Nxx1D**

Product Name	①② ③	Volta ge
RP171N121D	<b>JBA</b>	1.2V
RP171N121D5	<b>JBB</b>	1.25V
RP171N131D	<b>JBC</b>	1.3V
RP171N141D	<b>JBD</b>	1.4V
RP171N151D	<b>JBE</b>	1.5V
RP171N161D	<b>JBF</b>	1.6V
RP171N171D	<b>JBG</b>	1.7V
RP171N181D	<b>JBH</b>	1.8V
RP171N181D5	<b>JBJ</b>	1.85V
RP171N191D	<b>JBK</b>	1.9V
RP171N201D	<b>JBL</b>	2.0V
RP171N211D	<b>JBM</b>	2.1V
RP171N221D	<b>JBN</b>	2.2V
RP171N231D	<b>JBP</b>	2.3V
RP171N241D	<b>JBQ</b>	2.4V
RP171N251D	<b>JBR</b>	2.5V
RP171N261D	<b>JBS</b>	2.6V
RP171N271D	<b>JBT</b>	2.7V
RP171N281D	<b>JBU</b>	2.8V
RP171N281D5	<b>JBV</b>	2.85V
RP171N291D	<b>JBW</b>	2.9V

Product Name	①② ③	Volta ge
RP171N301D	<b>JBX</b>	3.0V
RP171N311D	<b>JBZ</b>	3.1V
RP171N321D	<b>JBZ</b>	3.2V
RP171N331D	<b>KBA</b>	3.3V
RP171N341D	<b>KBB</b>	3.4V
RP171N351D	<b>KBC</b>	3.5V
RP171N361D	<b>KBD</b>	3.6V
RP171N371D	<b>KBE</b>	3.7V
RP171N381D	<b>KBF</b>	3.8V
RP171N391D	<b>KBG</b>	3.9V
RP171N401D	<b>KBH</b>	4.0V
RP171N411D	<b>KBJ</b>	4.1V
RP171N421D	<b>KBK</b>	4.2V
RP171N431D	<b>KBL</b>	4.3V
RP171N441D	<b>KBM</b>	4.4V
RP171N451D	<b>KBN</b>	4.5V
RP171N461D	<b>KBP</b>	4.6V
RP171N471D	<b>KBQ</b>	4.7V
RP171N481D	<b>KBR</b>	4.8V
RP171N491D	<b>KBS</b>	4.9V

Product Name	①② ③	Volta ge
RP171N501D	<b>KBT</b>	5.0V
RP171N511D	<b>KBU</b>	5.1V
RP171N521D	<b>KBV</b>	5.2V
RP171N531D	<b>KBW</b>	5.3V
RP171N541D	<b>KBX</b>	5.4V
RP171N551D	<b>KBY</b>	5.5V
RP171N561D	<b>KBZ</b>	5.6V
RP171N571D	<b>LBA</b>	5.7V
RP171N581D	<b>LBB</b>	5.8V
RP171N591D	<b>LBC</b>	5.9V
RP171N601D	<b>LBD</b>	6.0V

## TEST CIRCUITS



**Basic Test Circuit**



**Test Circuit for Supply Current**



**Test Circuit for Ripple Rejection**



**Test Circuit for Load Transient Response**

## TYPICAL CHARACTERISTICS

### 1) Output Voltage vs. Output Current ( $T_{opt}=25^{\circ}C$ )



### 2) Output Voltage vs. Input Voltage ( $T_{opt}=25^{\circ}C$ )

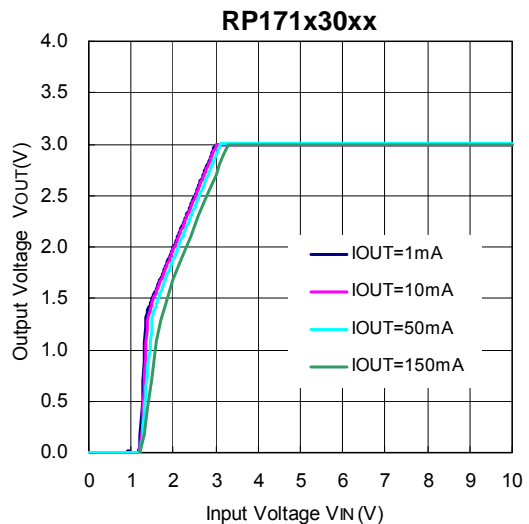



**3) Supply Current vs. Input Voltage ( $T_{opt}=25^{\circ}C$ )**

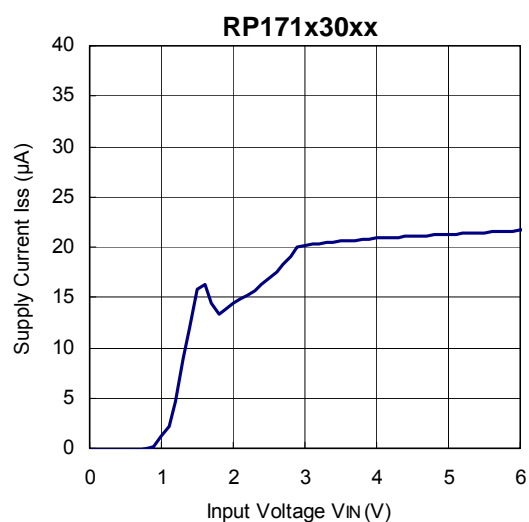

---

# RP171x

NO.EA-245-160324

---

## 4) Supply Current vs. Output Current (T<sub>opt</sub>=25°C)



## 5) Output Voltage vs. Temperature

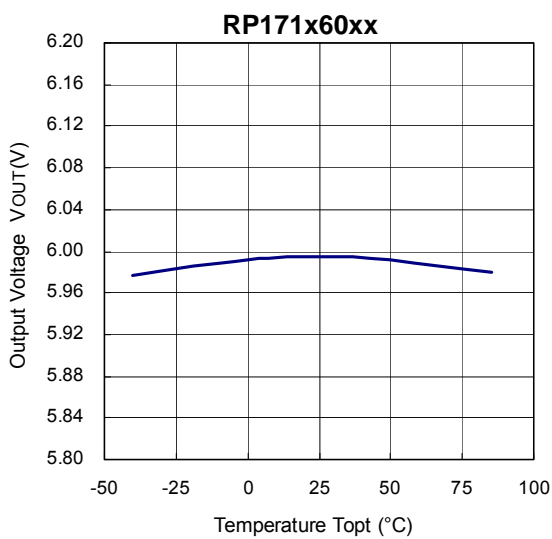
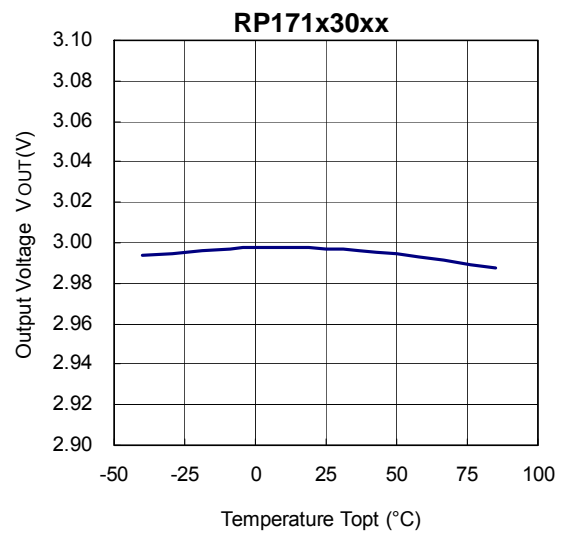
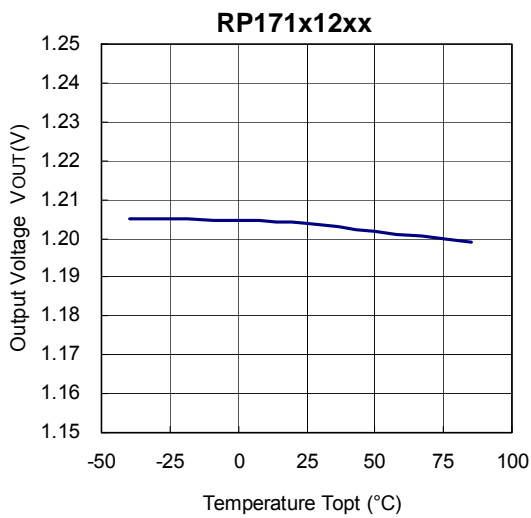



6) Supply Current vs. Temperature



7) Dropout Voltage vs. Output Current



# RP171x

NO.EA-245-160324



## 8) Dropout Voltage vs. Set Output Voltage ( $T_{opt}=25^{\circ}\text{C}$ )



## 9) Minimum Operating Voltage



10) Ripple Rejection vs. Input Bias Voltage (C1=none, C2=Ceramic 1.0μF, Ripple=0.2Vp-p, T<sub>opt</sub>=25°C)



11) Ripple Rejection vs. Frequency (C1=none, C2=Ceramic 1.0μF, T<sub>opt</sub>=25°C)



# RP171x

NO.EA-245-160324



## 12) Input Transient Response (C1=none, IOUT=30mA, tr=tf=5μs, Topt=25°C)





**13) Load Transient Response (C1=Ceramic 1.0 $\mu$ F,  $t_r=t_f=500ns$ ,  $T_{opt}=25^{\circ}C$ )**



RP171x12xx



RP171x30xx



RP171x30xx



RP171x30xx





# RP171x

NO.EA-245-160324

## 14) Turn On Speed with CE pin (C1=Ceramic 1.0 $\mu$ F, T<sub>opt</sub>=25°C)





**RP171x12xx**

$V_{IN}=2.6V, I_{OUT}=1mA$

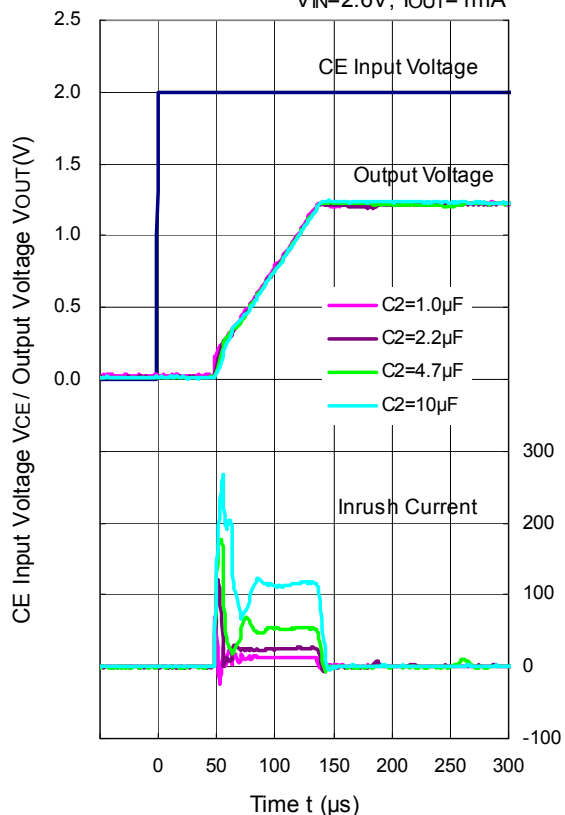

**RP171x30xx**

$V_{IN}=4.0V, I_{OUT}=1mA$

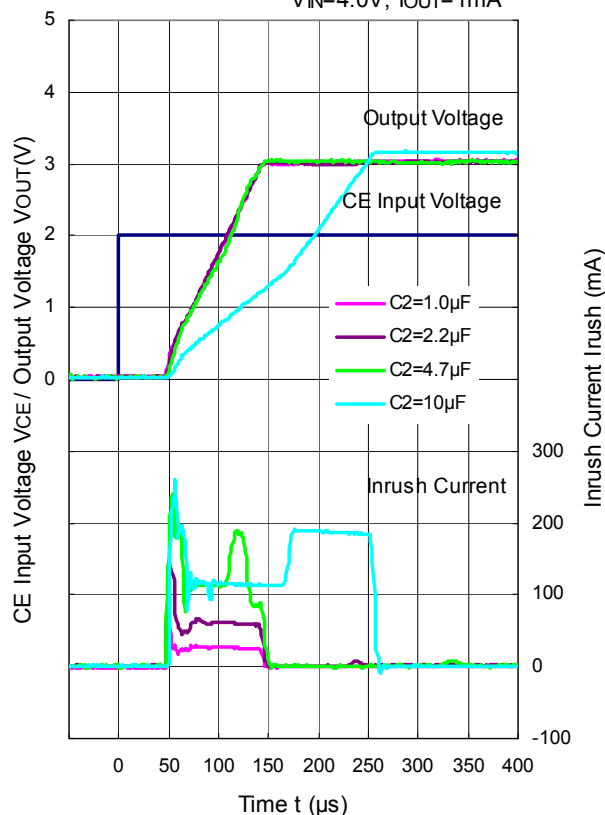

**RP171x60xx**

$V_{IN}=7.0V, I_{OUT}=1mA$



# RP171x

NO.EA-245-160324

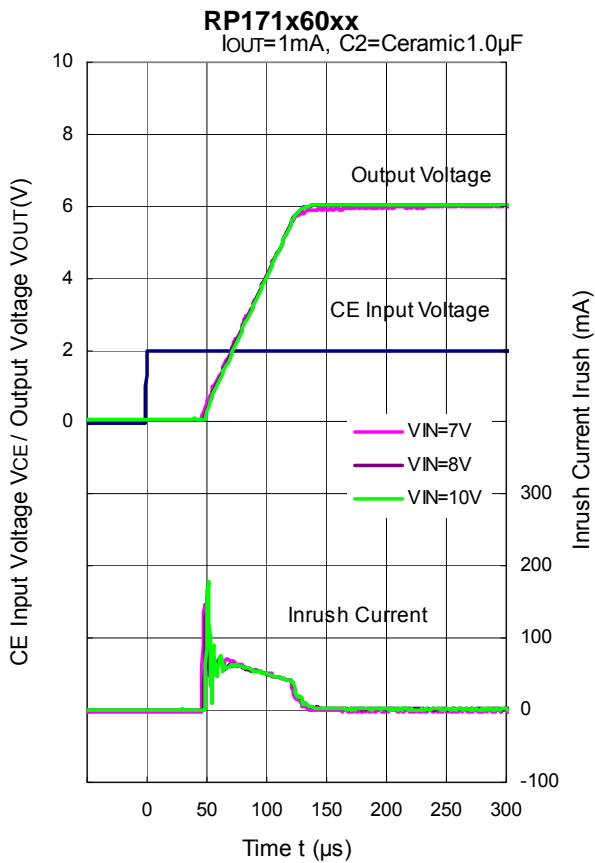
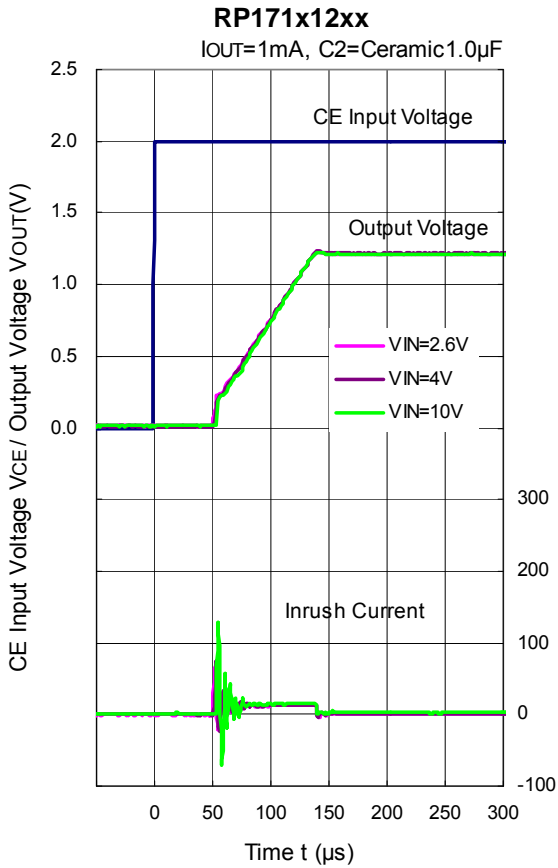

15) Turn Off Speed with CE pin (D Version) (C1=Ceramic 1.0μF, T<sub>opt</sub>=25°C)

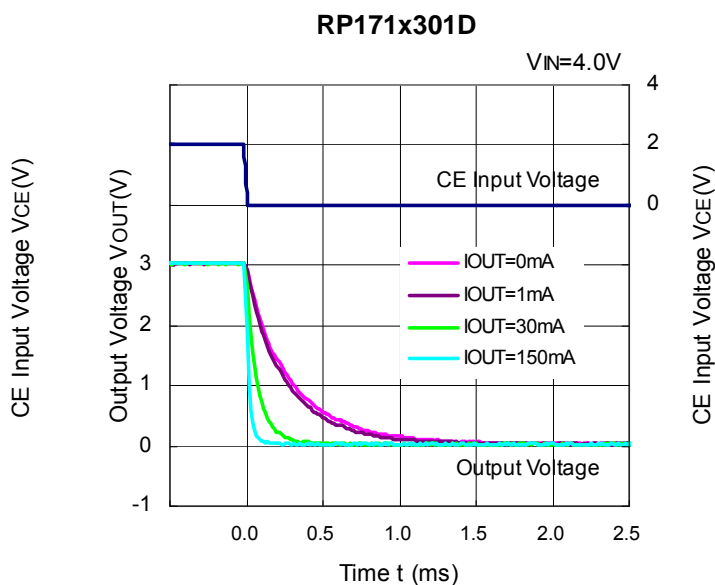

## ESR vs. Output Current

When using these ICs, consider the following points:

The relations between  $I_{OUT}$  (Output Current) and ESR of an output capacitor are shown below.

The conditions when the white noise level is under  $40\mu\text{V}$  (Avg.) are marked as the hatched area in the graph.

### Measurement conditions

Frequency Band : 10Hz to 2MHz

Temperature :  $-40^{\circ}\text{C}$  to  $85^{\circ}\text{C}$

C1, C2 : Ceramic  $1.0\mu\text{F}$  (Murata GRM155B31A105KE)





1. The products and the product specifications described in this document are subject to change or discontinuation of production without notice for reasons such as improvement. Therefore, before deciding to use the products, please refer to Ricoh sales representatives for the latest information thereon.
2. The materials in this document may not be copied or otherwise reproduced in whole or in part without prior written consent of Ricoh.
3. Please be sure to take any necessary formalities under relevant laws or regulations before exporting or otherwise taking out of your country the products or the technical information described herein.
4. The technical information described in this document shows typical characteristics of and example application circuits for the products. The release of such information is not to be construed as a warranty of or a grant of license under Ricoh's or any third party's intellectual property rights or any other rights.
5. The products listed in this document are intended and designed for use as general electronic components in standard applications (office equipment, telecommunication equipment, measuring instruments, consumer electronic products, amusement equipment etc.). Those customers intending to use a product in an application requiring extreme quality and reliability, for example, in a highly specific application where the failure or misoperation of the product could result in human injury or death (aircraft, spacevehicle, nuclear reactor control system, traffic control system, automotive and transportation equipment, combustion equipment, safety devices, life support system etc.) should first contact us.
6. We are making our continuous effort to improve the quality and reliability of our products, but semiconductor products are likely to fail with certain probability. In order to prevent any injury to persons or damages to property resulting from such failure, customers should be careful enough to incorporate safety measures in their design, such as redundancy feature, fire containment feature and fail-safe feature. We do not assume any liability or responsibility for any loss or damage arising from misuse or inappropriate use of the products.
7. Anti-radiation design is not implemented in the products described in this document.
8. Please contact Ricoh sales representatives should you have any questions or comments concerning the products or the technical information.



**Ricoh is committed to reducing the environmental loading materials in electrical devices with a view to contributing to the protection of human health and the environment.**

Ricoh has been providing RoHS compliant products since April 1, 2006 and Halogen-free products since April 1, 2012.

**RICOH** RICOH ELECTRONIC DEVICES CO., LTD.

<http://www.e-devices.ricoh.co.jp/en/>

#### Sales & Support Offices

##### **RICOH ELECTRONIC DEVICES CO., LTD.**

**Higashi-Shinagawa Office (International Sales)**  
3-32-3, Higashi-Shinagawa, Shinagawa-ku, Tokyo 140-8655, Japan  
Phone: +81-3-5479-2857 Fax: +81-3-5479-0502

##### **RICOH EUROPE (NETHERLANDS) B.V.**

**Semiconductor Support Centre**  
Prof. W.H. Keesomlaan 1, 1183 DJ Amstelveen, The Netherlands  
Phone: +31-20-5474-309

##### **RICOH INTERNATIONAL B.V. - German Branch**

**Semiconductor Sales and Support Centre**  
Oberrather Strasse 6, 40472 Düsseldorf, Germany  
Phone: +49-211-6546-0

##### **RICOH ELECTRONIC DEVICES KOREA CO., LTD.**

3F, Haesung Bldg, 504, Teheran-ro, Gangnam-gu, Seoul, 135-725, Korea  
Phone: +82-2-2135-5700 Fax: +82-2-2051-5713

##### **RICOH ELECTRONIC DEVICES SHANGHAI CO., LTD.**

Room 403, No.2 Building, No.690 Bibo Road, Pu Dong New District, Shanghai 201203, People's Republic of China  
Phone: +86-21-5027-3200 Fax: +86-21-5027-3299

##### **RICOH ELECTRONIC DEVICES CO., LTD.**

**Taipei office**  
Room 109, 10F-1, No.51, Hengyang Rd., Taipei City, Taiwan (R.O.C.)  
Phone: +886-2-2313-1621/1622 Fax: +886-2-2313-1623

# Mouser Electronics

Authorized Distributor

Click to View Pricing, Inventory, Delivery & Lifecycle Information:

## Ricoh Electronics:

[RP171N251B-TR-FE](#) [RP171N181B-TR-FE](#) [RP171N281D-TR-FE](#) [RP171N331B-TR-FE](#) [RP171N301D-TR-FE](#)  
[RP171N601B-TR-FE](#) [RP171N501D-TR-FE](#) [RP171N151B-TR-FE](#) [RP171N121B-TR-FE](#) [RP171N301B-TR-FE](#)  
[RP171N331D-TR-FE](#) [RP171N281B-TR-FE](#) [RP171N501B-TR-FE](#)

Компания «Океан Электроники» предлагает заключение долгосрочных отношений при поставках импортных электронных компонентов на взаимовыгодных условиях!

Наши преимущества:

- Поставка оригинальных импортных электронных компонентов напрямую с производств Америки, Европы и Азии, а так же с крупнейших складов мира;
- Широкая линейка поставок активных и пассивных импортных электронных компонентов (более 30 млн. наименований);
- Поставка сложных, дефицитных, либо снятых с производства позиций;
- Оперативные сроки поставки под заказ (от 5 рабочих дней);
- Экспресс доставка в любую точку России;
- Помощь Конструкторского Отдела и консультации квалифицированных инженеров;
- Техническая поддержка проекта, помощь в подборе аналогов, поставка прототипов;
- Поставка электронных компонентов под контролем ВП;
- Система менеджмента качества сертифицирована по Международному стандарту ISO 9001;
- При необходимости вся продукция военного и аэрокосмического назначения проходит испытания и сертификацию в лаборатории (по согласованию с заказчиком);
- Поставка специализированных компонентов военного и аэрокосмического уровня качества (Xilinx, Altera, Analog Devices, Intersil, Interpoint, Microsemi, Actel, Aeroflex, Peregrine, VPT, Syfer, Eurofarad, Texas Instruments, MS Kennedy, Miteq, Cobham, E2V, MA-COM, Hittite, Mini-Circuits, General Dynamics и др.);

Компания «Океан Электроники» является официальным дистрибьютором и эксклюзивным представителем в России одного из крупнейших производителей разъемов военного и аэрокосмического назначения «JONHON», а так же официальным дистрибьютором и эксклюзивным представителем в России производителя высокотехнологичных и надежных решений для передачи СВЧ сигналов «FORSTAR».



## JONHON

«JONHON» (основан в 1970 г.)

Разъемы специального, военного и аэрокосмического назначения:

(Применяются в военной, авиационной, аэрокосмической, морской, железнодорожной, горно- и нефтедобывающей отраслях промышленности)

«FORSTAR» (основан в 1998 г.)

ВЧ соединители, коаксиальные кабели, кабельные сборки и микроволновые компоненты:

(Применяются в телекоммуникациях гражданского и специального назначения, в средствах связи, РЛС, а так же военной, авиационной и аэрокосмической отраслях промышленности).



Телефон: 8 (812) 309-75-97 (многоканальный)

Факс: 8 (812) 320-03-32

Электронная почта: [ocean@oceanchips.ru](mailto:ocean@oceanchips.ru)

Web: <http://oceanchips.ru/>

Адрес: 198099, г. Санкт-Петербург, ул. Калинина, д. 2, корп. 4, лит. А