



RoHS compliant

FEATURES

• **Excellent high frequency characteristics (50Ω, at 5GHz)**

V.S.W.R.: Max. 1.25

Insertion loss: Max. 0.5dB

Isolation: Min. 35dB

(Between open contacts)

Min. 30dB

(Between contact sets)

• **Surface mount terminal**

Surface mount terminals are now standard so there is much less work in designing PC boards.

• **Small size**

Size: 14.00 (L)×9.00 (W)×8.20 (H) mm

.551 (L)×.354 (W)×.323 (H) inch

TYPICAL APPLICATIONS

• **Measuring equipment market**

Attenuator circuits, spectrum analyzer, oscilloscope, Telecommunication equipment and tester inspection.

• **Network communications market**

Microwave communication

• **Medical instrument market**

If you wish to use in applications with low level loads or with high frequency switching, please consult us.

ORDERING INFORMATION



TYPES

1. Standard PC board terminal

| Contact arrangement | Nominal coil voltage | Part No. | |
|---------------------|----------------------|--------------------|-----------------|
| | | Single side stable | 2 coil latching |
| 2 Form C | 3 V DC | ARJ2003 | ARJ2203 |
| | 4.5V DC | ARJ204H | ARJ224H |
| | 12 V DC | ARJ2012 | ARJ2212 |
| | 24 V DC | ARJ2024 | ARJ2224 |

Standard packing: 50 pcs. in an inner package; 500 pcs. in an outer package

2. Surface-mount terminal

1) Carton packing

| Contact arrangement | Nominal coil voltage | Part No. | |
|---------------------|----------------------|--------------------|-----------------|
| | | Single side stable | 2 coil latching |
| 2 Form C | 3 V DC | ARJ20A03 | ARJ22A03 |
| | 4.5V DC | ARJ20A4H | ARJ22A4H |
| | 12 V DC | ARJ20A12 | ARJ22A12 |
| | 24 V DC | ARJ20A24 | ARJ22A24 |

Standard packing: 50 pcs. in an inner package; 500 pcs. in an outer package

2) Tape and reel packing

| Contact arrangement | Nominal coil voltage | Part No. | |
|---------------------|----------------------|--------------------|-----------------|
| | | Single side stable | 2 coil latching |
| 2 Form C | 3 V DC | ARJ20A03Z | ARJ22A03Z |
| | 4.5V DC | ARJ20A4HZ | ARJ22A4HZ |
| | 12 V DC | ARJ20A12Z | ARJ22A12Z |
| | 24 V DC | ARJ20A24Z | ARJ22A24Z |

Standard packing: 500 pcs. in an inner package; 1,000 pcs. in an outer package

Note: Tape and reel packing symbol "-Z" is not marked on the relay. "X" type tape and reel packing (picked from 1/2/3-pin side) is also available. Suffix "X" instead of "Z".

RATING

1. Coil data

1) Single side stable

| Nominal coil voltage | Pick-up voltage (at 20°C 68°F) | Drop-out voltage (at 20°C 68°F) | Nominal operating current [$\pm 10\%$] (at 20°C 68°F) | Coil resistance [$\pm 10\%$] (at 20°C 68°F) | Nominal operating power | Max. applied voltage (at 70°C 158°F) |
|----------------------|---|---|---|---|-------------------------|--------------------------------------|
| 3 V DC | 75%V or less of nominal voltage (Initial) | 10%V or more of nominal voltage (Initial) | 66.6mA | 45 Ω | 200mW | 110%V of nominal voltage |
| 4.5V DC | | | 44.4mA | 101.2 Ω | | |
| 12 V DC | | | 16.6mA | 720 Ω | | |
| 24 V DC | | | 8.3mA | 2,880 Ω | | |

2) 2 coil latching

| Nominal coil voltage | Set voltage (at 20°C 68°F) | Reset voltage (at 20°C 68°F) | Nominal operating current [$\pm 10\%$] (at 20°C 68°F) | Coil resistance [$\pm 10\%$] (at 20°C 68°F) | Nominal operating power | Max. applied voltage (at 70°C 158°F) |
|----------------------|---|---|---|---|-------------------------|--------------------------------------|
| 3 V DC | 75%V or less of nominal voltage (Initial) | 75%V or less of nominal voltage (Initial) | 50 mA | 60 Ω | 150mW | 110%V of nominal voltage |
| 4.5V DC | | | 33.3mA | 135 Ω | | |
| 12 V DC | | | 12.5mA | 960 Ω | | |
| 24 V DC | | | 6.3mA | 3,840 Ω | | |

2. Specifications

| Characteristics | Item | Specifications | |
|--|--|--|--|
| Contact | Arrangement | 2 Form C | |
| | Contact material | Gold plating | |
| | Initial contact resistance, max. | Max. 150m Ω (By voltage drop 10V DC 10mA) | |
| Rating | Contact rating | 1W (at 5GHz, Impedance 50 Ω , V.S.W.R. ≤ 1.25) 10mA 10V DC (resistive load) | |
| | Contact carrying power | 1W (at 5GHz, Impedance 50 Ω , V.S.W.R. ≤ 1.25) | |
| | Max. switching voltage | 30V DC | |
| | Max. switching current | 0.3A DC | |
| | Nominal operating power | Single side stable: 200mW, 2 coil latching: 150mW | |
| High frequency characteristics (Initial) (~5GHz, Impedance 50 Ω) | V.S.W.R. | Max. 1.25 | |
| | Insertion loss (without D.U.T. board's loss) | Max. 0.5dB | |
| | Isolation | Between open contacts | Min. 35dB |
| | | Between contact sets | Min. 30dB |
| Input power | 1W (at 5GHz, impedance 50 Ω , V.S.W.R. ≤ 1.25 , at 20°C) | | |
| Electrical characteristics | Insulation resistance (Initial) | Min. 500M Ω (at 500V DC) Measurement at same location as "Initial breakdown voltage" section. | |
| | Breakdown voltage (Initial) | Between open contacts | 500 Vrms for 1min. (Detection current: 10mA) |
| | | Between contact sets | 500 Vrms for 1min. (Detection current: 10mA) |
| | | Between contact and coil | 500 Vrms for 1min. (Detection current: 10mA) |
| | | Between coil and earth terminal | 500 Vrms for 1min. (Detection current: 10mA) |
| | Between contact and earth terminal | 500 Vrms for 1min. (Detection current: 10mA) | |
| | Temperature rise (at 20°C) | Max. 50°C (By resistive method, nominal voltage applied to the coil, 5GHz, V.S.W.R. ≤ 1.25) | |
| | Operate time [Set time] (at 20°C) | Max. 5ms (Nominal operating voltage applied to the coil, excluding contact bounce time.) | |
| Release time [Reset time] (at 20°C) | Max. 5ms (Nominal operating voltage applied to the coil, excluding contact bounce time.) (without diode) | | |
| Mechanical characteristics | Shock resistance | Functional | Min. 500 m/s ² (Half-wave pulse of sine wave: 6ms; detection time: 10 μ s.) |
| | | Destructive | Min. 1,000 m/s ² (Half-wave pulse of sine wave: 11ms.) |
| | Vibration resistance | Functional | 10 to 55 Hz at double amplitude of 3mm (Detection time: 10 μ s.) |
| | | Destructive | 10 to 55 Hz at double amplitude of 5mm |
| Expected life | Mechanical | Min. 10 ⁷ (at 180 cpm) | |
| | Electrical | Min. 10 ⁶ (at 20 cpm) (1W, at 5GHz, V.S.W.R. ≤ 1.25) Min. 10 ⁶ (at 20 cpm) (10mA 10V DC resistive load) | |
| Conditions | Conditions for operation, transport and storage* | Ambient temperature: -30°C to +70°C -22°F to +158°F Humidity: 5 to 85% R.H. (Not freezing and condensing at low temperature) | |
| Unit weight | | Approx. 3 g .11 oz | |

Note: * The upper operation ambient temperature limit is the maximum temperature that can satisfy the coil temperature rise value. Refer to [6] AMBIENT ENVIRONMENT in GENERAL APPLICATION GUIDELINES.

RJ (ARJ)

REFERENCE DATA

1. High frequency characteristics

Sample: ARJ20A12

Measuring method: Measured with HP network analyzer (HP8510C).

• V.S.W.R. characteristics



• Insertion loss characteristics
(without D.U.T. board's loss)



• Isolation characteristics



DIMENSIONS (mm inch)

The CAD data of the products with a **CAD Data** mark can be downloaded from: <http://industrial.panasonic.com/ac/e/>

1. Standard PC board terminal

CAD Data

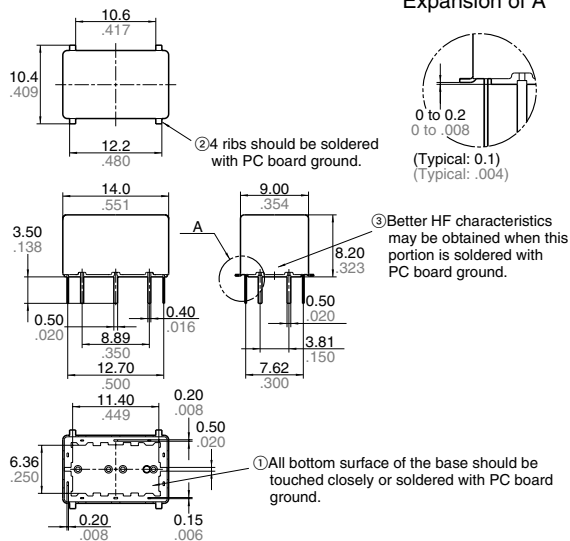

Expansion of A

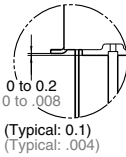

Schematic (Bottom view)

Single side stable

2 coil latching

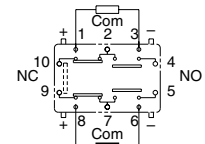
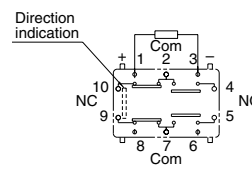

(Deenergized condition)

(Reset condition)

General tolerance: $\pm 0.3 \pm 0.12$

2. Surface mount terminal

CAD Data

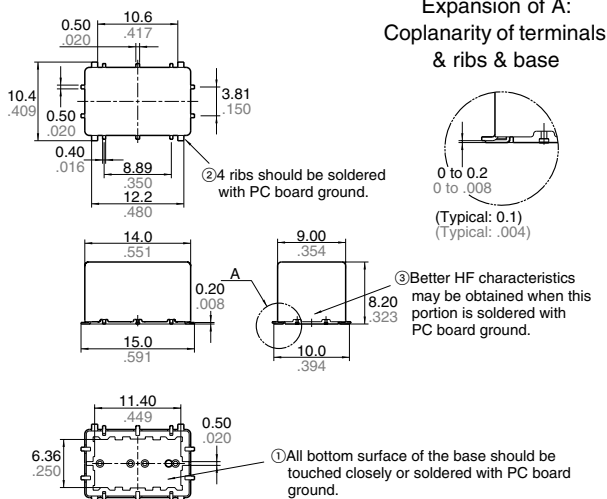

Expansion of A:
Coplanarity of terminals
& ribs & base

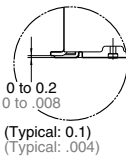

Schematic (Top view)

Single side stable

2 coil latching

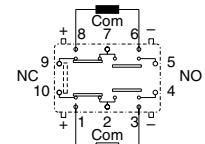
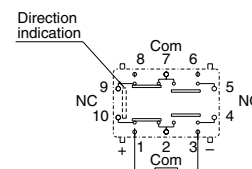

(Deenergized condition)

(Reset condition)

General tolerance: $\pm 0.3 \pm 0.12$

Note: Please consult us regarding recommended PC board patterns.

NOTES

1. Coil operating power

Pure DC current should be applied to the coil. The wave form should be rectangular. If it includes ripple, the ripple factor should be less than 5%.

However, check it with the actual circuit since the characteristics may be slightly different. The nominal operating voltage should be applied to the coil for more than 20 ms to set/reset the latching type relay.

2. Coil connection

When connecting coils, refer to the wiring diagram to prevent mis-operation or malfunction.

3. External magnetic field

Since RJ relays are highly sensitive polarized relays, their characteristics will be affected by a strong external magnetic field. Avoid using the relay under that condition.

4. Cleaning

For automatic cleaning, the boiling method is recommended. Avoid ultrasonic cleaning which subjects the relays to high frequency vibrations, which may cause the contacts to stick.

It is recommended that alcoholic solvents be used.

5. Tape and reel packing

1) Tape dimensions



2) Dimensions of plastic reel

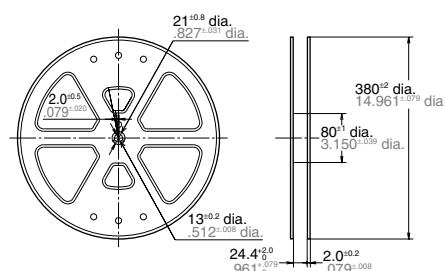

6. Conditions for operation, transport and storage conditions

1) Ambient temperature, humidity, and atmospheric pressure during usage, transport, and storage of the relay:

(1) Temperature:

−30 to +70°C −22 to +158°F

(However, tolerance range is −30 to +60°C −22 to +140°F if package is carried as is.)

(2) Humidity: 5 to 85% RH

(Avoid freezing and condensation.)

The humidity range varies with the temperature. Use within the range indicated in the graph below.

(3) Atmospheric pressure: 86 to 106 kPa

Temperature and humidity range for usage, transport, and storage:



2) Condensation

Condensation forms when there is a sudden change in temperature under high temperature and high humidity conditions. Condensation will cause deterioration of the relay insulation.

3) Freezing

Condensation or other moisture may freeze on the relay when the temperature is lower than 0°C 32°F. This causes problems such as sticking of movable parts or operational time lags.

4) Low temperature, low humidity environments

The plastic becomes brittle if the relay is exposed to a low temperature, low humidity environment for long periods of time.

5) Storage procedures for surface-mount terminal types

Since the relay is very sensitive to humidity, it is packed in humidity-free, hermetically sealed packaging. When storing the relay, be careful of the following points:

(1) Be sure to use the relay immediately after removing it from its sealed package.

(2) When storing the relay for long periods of time after removing it from its sealed package, we recommend using a humidity-free bag with silica gel to prevent subjecting the relay to humidity. Furthermore, if the relay is solder mounted when it has been subjected to excessive humidity, cracks and leaks can

occur. Be sure to mount the relay under the required mounting conditions.

7. Soldering

1) Surface-mount terminal

In case of automatic soldering, the following conditions should be observed

(1) Position of measuring temperature

Surface of PC board where relay is mounted.



(2) IR (infrared reflow) soldering method



T₁ = 150 to 180°C 302 to 356°F t₁ = 60 to 120 sec.
T₂ = 230°C 446°F and higher t₂ = Within 30 sec.
T₃ = Within 250°C 482°F

Temperature rise of relay itself may vary according to the mounting level or the heating method of reflow equipment. Therefore, please set the temperature of soldering portion of relay terminal and the top surface of the relay case not to exceed the above mentioned soldering condition.

It is recommended to check the temperature rise of each portion under actual mounting condition before use.

2) Standard PC board terminal
Please meet the following conditions if this relay is to be automatically soldered.

(1) Preheating: Max. 120°C 248°F

(terminal solder surface) for max. 120 seconds

(2) Soldering: Max. 260±5°C 500±9°F for max. 6 seconds

The effect on the relay depends on the actual substrate used. Please verify the substrate to be used.

Moisture-proof packaging enables RJ relay's standard PCB type capable for reflow soldering.

Please contact us in the case of reflow soldering considerations.

3) Hand soldering

Please meet the following conditions if this relay is to be soldered by hand.

(1) Wattage: 30 to 60 W

(2) Tip temperature/time: 280 to 300°C 536 to 572°F for max. 5 seconds

The effect on the relay depends on the actual substrate used. Please verify the substrate to be used.

4) Avoid high frequency cleaning since this may adversely affect relay characteristics. Use alcohol-based cleaning solutions when cleaning relays.

RJ (ARJ)

8. Measuring method (Impedance 50Ω)



Connector

| No. | Product name | Contents |
|-----|----------------|----------------------------------|
| 1 | HP 85131-60013 | 3.5 mm testport, Extension cable |
| 2 | HP 83059 | 3.5 mm coaxial adaptor |

(Step 1) Calibrate the test system with HP calibration kit [HP85052B]

(Step 2) After calibration, connect the D.U.T. board and measure. Connect 50 Ω terminals on connectors other than those for measurement.

Notes:

- All bottom surface of the base should be touched closely or soldered with PC board ground.
- 4 ribs should be soldered with PC board ground.

Measuring board

1) Dimensions

<Surface mount terminal>

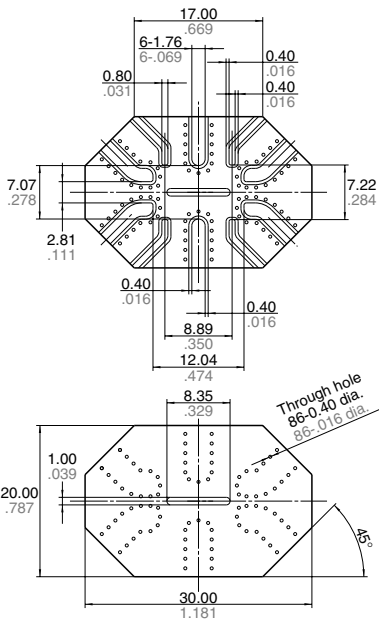

<Standard PC board terminal>

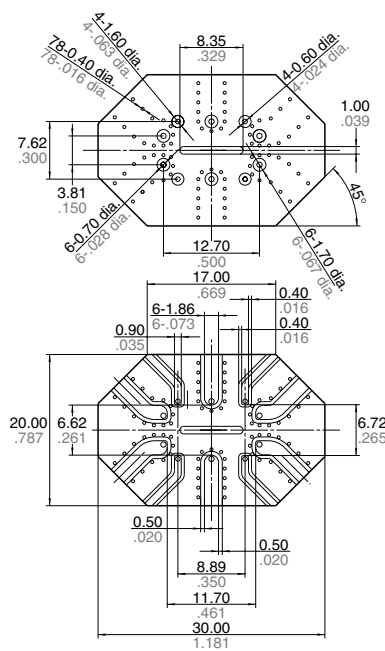

<Calibration board>

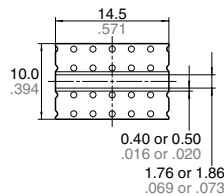

2) Material: Glass PTFE double-sided through hole PC board R-4737 (Panasonic Corporation)

3) Board thickness: $t = 0.8 \text{ mm}$
4) Copper plating: $18\mu\text{m}$

• Connector (SMA type receptacle)
Product name: R125 510 (RADIALL)
Insertion loss compensation

The insertion loss of relay itself is given by subtracting the insertion loss of short-circuit the Com and the NC (or NO). (signal path and two connectors)

9. Others

1) The switching lifetime is defined under the standard test condition specified in the JIS* C 5442-1996 standard (temperature 15 to 35°C 59 to 95°F, humidity 25 to 75%). Check this with the real device as it is affected by coil driving circuit, load type, activation frequency, activation phase, ambient conditions and other factors.

Also, be especially careful of loads such as those listed below.

• When used for AC load-operating and the operating phase is synchronous. Rocking and fusing can easily occur due to contact shifting.

• High-frequency load-operating
When high-frequency opening and closing of the relay is performed with a load that causes arcs at the contacts, nitrogen and oxygen in the air is fused by the arc energy and HNO_3 is formed. This can corrode metal materials.

Three countermeasures for these are listed here.

- Incorporate an arc-extinguishing circuit.
 - Lower the operating frequency
 - Lower the ambient humidity
- 2) Use the relay within specifications such as coil rating, contact rating and on/off service life. If used beyond limits, the relay may overheat, generate smoke or catch fire.

3) Be careful not to drop the relay. If accidentally dropped, carefully check its appearance and characteristics before use.

4) Be careful to wire the relay correctly. Otherwise, malfunction, overheat, fire or other trouble may occur.

5) If a relay stays on in a circuit for many months or years at a time without being activated, circuit design should be reviewed so that the relay can remain non-excited. A coil that receives current all the time heats, which degrades insulation earlier than expected. A latching type relay is recommended for such circuits.

6) The latching type relay is shipped in the reset position. But jolts during transport or impacts during installation can change the reset position. It is, therefore, advisable to build a circuit in which the relay can be initialized (set and reset) just after turning on the power.

7) If silicone materials (e.g., silicone rubbers, silicone oils, silicone coating agents, silicone sealers) are used in the vicinity of the relay, the gas emitted from the silicone may adhere to the contacts of the relay during opening and closing and lead to improper contact. If this is the case, use a material other than silicone.

8) We recommend latching type when using in applications which involve lengthy duty cycles.

* Japanese Industrial Standards

For general cautions for use, please refer to the "General Application Guidelines".

Mouser Electronics

Authorized Distributor

Click to View Pricing, Inventory, Delivery & Lifecycle Information:

Panasonic:

[ARJ20A4H](#) [ARJ22A12](#) [ARJ2003](#) [ARJ2012](#) [ARJ2024](#) [ARJ204H](#) [ARJ20A03](#) [ARJ20A12X](#) [ARJ20A24](#) [ARJ20A4HX](#)
[ARJ20A4HZ](#) [ARJ2203](#) [ARJ2212](#) [ARJ2224](#) [ARJ224H](#) [ARJ22A03](#) [ARJ22A12X](#) [ARJ22A12Z](#) [ARJ22A24](#)
[ARJ22A4HZ](#) [ARJ20A12Z](#) [ARJ22A4H](#) [ARJ20A12](#) [ARJ22A4HX](#)

Компания «Океан Электроники» предлагает заключение долгосрочных отношений при поставках импортных электронных компонентов на взаимовыгодных условиях!

Наши преимущества:

- Поставка оригинальных импортных электронных компонентов напрямую с производств Америки, Европы и Азии, а так же с крупнейших складов мира;
- Широкая линейка поставок активных и пассивных импортных электронных компонентов (более 30 млн. наименований);
- Поставка сложных, дефицитных, либо снятых с производства позиций;
- Оперативные сроки поставки под заказ (от 5 рабочих дней);
- Экспресс доставка в любую точку России;
- Помощь Конструкторского Отдела и консультации квалифицированных инженеров;
- Техническая поддержка проекта, помощь в подборе аналогов, поставка прототипов;
- Поставка электронных компонентов под контролем ВП;
- Система менеджмента качества сертифицирована по Международному стандарту ISO 9001;
- При необходимости вся продукция военного и аэрокосмического назначения проходит испытания и сертификацию в лаборатории (по согласованию с заказчиком);
- Поставка специализированных компонентов военного и аэрокосмического уровня качества (Xilinx, Altera, Analog Devices, Intersil, Interpoint, Microsemi, Actel, Aeroflex, Peregrine, VPT, Syfer, Eurofarad, Texas Instruments, MS Kennedy, Miteq, Cobham, E2V, MA-COM, Hittite, Mini-Circuits, General Dynamics и др.);

Компания «Океан Электроники» является официальным дистрибьютором и эксклюзивным представителем в России одного из крупнейших производителей разъемов военного и аэрокосмического назначения «JONHON», а так же официальным дистрибьютором и эксклюзивным представителем в России производителя высокотехнологичных и надежных решений для передачи СВЧ сигналов «FORSTAR».



JONHON

«JONHON» (основан в 1970 г.)

Разъемы специального, военного и аэрокосмического назначения:

(Применяются в военной, авиационной, аэрокосмической, морской, железнодорожной, горно- и нефтедобывающей отраслях промышленности)

«FORSTAR» (основан в 1998 г.)

ВЧ соединители, коаксиальные кабели, кабельные сборки и микроволновые компоненты:

(Применяются в телекоммуникациях гражданского и специального назначения, в средствах связи, РЛС, а так же военной, авиационной и аэрокосмической отраслях промышленности).



Телефон: 8 (812) 309-75-97 (многоканальный)

Факс: 8 (812) 320-03-32

Электронная почта: ocean@oceanchips.ru

Web: <http://oceanchips.ru/>

Адрес: 198099, г. Санкт-Петербург, ул. Калинина, д. 2, корп. 4, лит. А