

## 7/16 and Composite 7/16 series

R185 / R187

**RADIAL**   
The next connexion



**Pages**

**7/16**

Introduction ..... 13-4

Interface ..... 13-6

Characteristics ..... 13-7 to 13-8

Straight plugs ..... 13-9

Right angle plugs ..... 13-10

Straight jacks ..... 13-11

Square flange jacks ..... 13-11

Bulkhead jacks ..... 13-12

Adapters ..... 13-13

**Composite 7/16**

Introduction ..... 13-4

Interface ..... 13-6

Characteristics ..... 13-8

Jacks and plugs ..... 13-14

Square flange jacks ..... 13-15

Panel drilling ..... 13-16

## INTRODUCTION



50Ω

DC - 7.5 GHz

### GENERAL

- Standard coaxial connectors
- Screw-on coupling
- High power rating
- Excellent RF performance

### APPLICABLE STANDARDS

- IEC 169-4
- DIN 47223
- CECC 22 190

### APPLICATIONS

- Mobile communication infrastructure networks: combiner, diplexer, filter...
- Jumper and feeder cables assemblies
- Radio links
- Indoor and outdoor applications

Radiall's 7/16 series has been developed using the latest technology advances in connector design. These connectors are easy to use, highly reliable, innovative and are designed to meet the needs of the telecommunications market. The complete connector series feature the following characteristics:

- An extensive range, with optimized component part design.
- An upgraded cross-knurled coupling nut allowing better manual tightening.

## New Eco series

Radiall introduced a complete range of Eco 7/16 connectors designed to be installed in telecommunications equipment such as remote radio heads, antennas, and filters. The modular design of these Eco 7/16 connectors offers multiple termination possibilities to fit numerous additional applications. There are more than 20 different connector variations currently available.

## New Composite 7/16

Radiall expanded its line of innovative 7/16 composite connectors with new plugs, jacks and receptacles as a lightweight, low cost, alternative to brass connectors. Manufactured with corrosion-proof, composite materials, these new single-piece connectors are UV resistant, meeting IEC 68-2-5 and IEC-68-2-9 to withstand all environments, including harsh outdoor installations. Radiall now offers over 20 different variations. The selection of the composite materials is a result of an in-depth competitive analysis of creeping speeds of zinc and aluminum alloys. Not only do the composite materials offer considerable performance advantages guaranteeing up to 500 matings; but with more than a 50% reduction in weight, this receptacle reduces the overall weight of the final module as well as transportation costs.

## High performance range

- Frequency range: DC - 7.5 GHz
- 2 types of coupling nut:
  - cross-knurled and 6 flats 27 mm wide coupling nut (3 000 N.cm),
  - 6 flats coupling nut (32 mm wide), allowing high coupling torque (3 500 N.cm), when used with a torque wrench.
- Intermodulation performance: 2 levels
  - 125 dBm cable assemblies
  - 110 dBm connectors and cable assemblies.

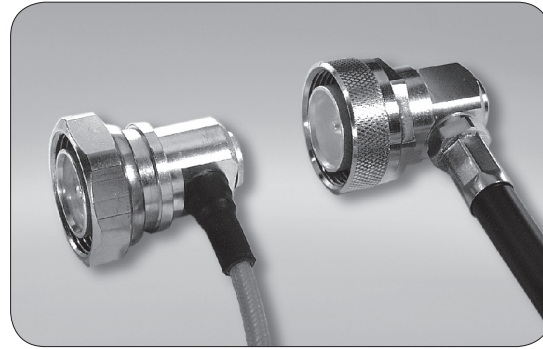

2 types of coupling nut

RADIALL has developed its intermodulation measurement equipment following the IEC 46 D/292/NP standard proposal. It is aimed at third-order IMP measurements through the reflection method. The range of this test set-up is -132 dBm (-175 dBc) under 2 x 20 W.

- High performance non-magnetic material (brass) and plating (silver) with anti-tarnishing finish (strike of BBR).
- Non-slotted outer contact on standard products.
- The 7/16 connector series benefits from a complete easy-to-use range of tooling.



## Custom models

To fulfill customer requirements, Radiall offers complete design of custom connectors according to the 7/16 series standard.

## What is INTERMODULATION ?

Intermodulation (IM) is an undesired modulation that leads to a distortion of the output high-frequency carrier. It is defined as the ratio of the 3rd order intermodulation products and the incident signal power because the most troublesome IM products are those of 3rd order.

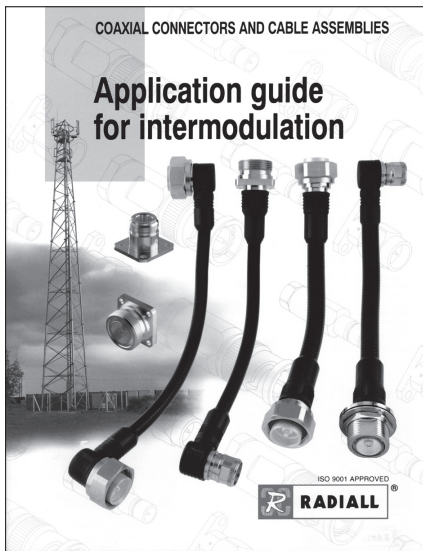

For more detailed information, including our intermodulation measurement system and our product range, please visit [www.radiall.com](http://www.radiall.com)

**INTERFACE**

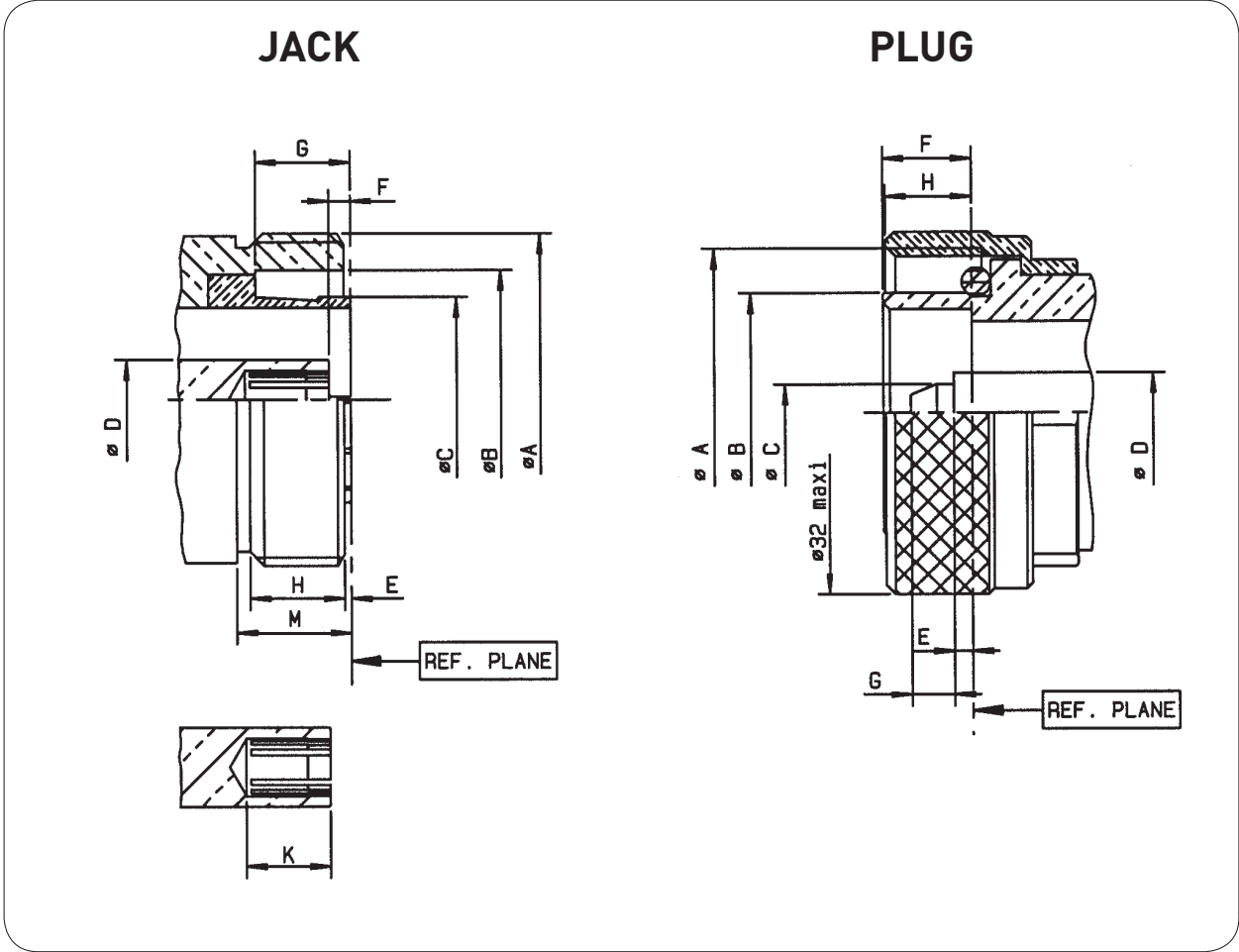

Letter	mm		inch	
	min.	max.	min.	max.
A DIA	M29 X 1.5		M29 X 1.5	
B DIA	22.5	22.7	.885	.893
C DIA	17.9	17.96	.704	.707
D DIA	6.95	7.00	.273	.275
E	0.50	0.70	.019	.027
F	1.77	2.07	.069	.081
G	8.20	8.40	.322	.330
H	8.25	8.75	.324	.344
K	7.25	7.55	.285	.297

Letter	mm		inch	
	min.	max.	min.	max.
A DIA	M29 X 1.5		M29 X 1.5	
B DIA	20.8	21.0	.818	.826
C DIA	4.97	5.03	.195	.198
D DIA	6.95	7.00	.273	.275
E	1.47	1.77	.057	.069
F	7.40	7.80	.291	.307
G	3.60	4.00	.141	.157
H	7.30	7.80	.287	.307

Test/characteristics	Standard reference	Values/remarks
----------------------	--------------------	----------------

## ELECTRICAL CHARACTERISTICS

Impedance		50Ω
Frequency range		DC - 7.5 GHz
Typical V.S.W.R.		1 GHz    2.5 GHz    5 GHz    7.5 GHz
• Straight models		1.10 max from DC to 3 GHz - 1.20 max from 3 to 7.5 GHz
RG213-RG214-RG393		1.04    1.06    1.08    1.10
.141"		1.04    1.07    1.08    1.20
.250"		1.03    1.05    1.11    1.13
1/2" superflexible corrugated		1.02    1.04    1.05    1.05
3/8" superflexible corrugated		1.03    1.03    1.12    1.20
1/4" superflexible corrugated		1.01    1.02    1.09    1.17
• Right angle models		1.15 max from DC to 3 GHz
RG213-RG214-RG393		1.02    1.04    1.12    1.50
1/2" superflexible corrugated		1.04    1.04    1.14    1.60
3/8" superflexible corrugated		1.05    1.08    1.12    1.80
1/4" superflexible corrugated		1.02    1.06    1.13    1.60
Intermodulation product (IMP <sub>3</sub> )		
• Connectors		-110 dBm typ. (- 153 dBc typ / 20 W)
• Home made cable assemblies		-125 dBm typ. (- 168 dBc typ. / 20 W)
Insertion loss (dB)	MIL	0.05 √F (GHz)
Straight connectors and right-angle connectors		
RF Leakage	CECC	130 dB at 1 GHz
Insulation resistance	CECC	10 000 MΩ min
Contact resistance		
• Center contact	CECC	< 0.4 mΩ
• Outer contact		≤ 1.5 mΩ
Working voltage in VRMS at sea level	CECC	2 700
Dielectric withstanding voltage in VRMS		
• at sea level	CECC	4 000
(at 70, 000 feet)		350

## MECHANICAL CHARACTERISTICS

Durability	CECC	500 matings
Force to engage and disengage	CECC	15 N
Recommended coupling nut torque		
• Hex. coupling nut		3 500 Ncm (with torque wrench R 282 303 500)
• Hex. + cross knurl coupling nut		3 000 Ncm (with torque wrench R 282 303 520)
Proof torque	CECC	3 500 Ncm
Coupling nut retention force	CECC	1 000 N
Cable retention force		
Cable 5/50 & 10/50		250 N
Cable 1/4"	CECC	200 N
Cable 3/8"		250 N
Cable 1/2"		350 N
Cable 7/8"		500 N
Center contact retention force	CECC	200 N

## ENVIRONMENTAL CHARACTERISTICS

Temperature range		
• flexible cables and corrugated cables	CECC	- 55 °C + 155 °C
• semi-rigid cables		- 55 °C + 105 °C
Thermo cycling test	CECC	- 55 °C / + 155 °C / 56 days
Rapid change of temperature	IEC	- 55 °C / + 155 °C / 5 cycles
High temperature test	CECC	1000 hours / 155 °C
Corrosion salt spray	IEC	48 hours / Na Cl 5% / 35 °C
Vibration	CECC	98 m/s <sup>2</sup> - 10 Hz at 500 Hz
Moisture resistance		
• clamp type	IEC 529	IP67
• crimp type		IP65 (with heatshrink sleeve)
• home made cable assemblies		IP68 (overmolding)
Hermetic test	IEC	5 Pa. cm <sup>3</sup> /s
Leakage	CECC	1 cm <sup>3</sup> /h max

## CHARACTERISTICS 7/16

### MATERIALS AND PLATINGS

	Materials	Plating
Bodies	Brass	Silver + BBR
Nut	Brass	BBR
Center contact male female	Brass Beryllium copper	Silver
Insulator	PTFE	
Gasket	Silicon rubber	

### POWER RANGE

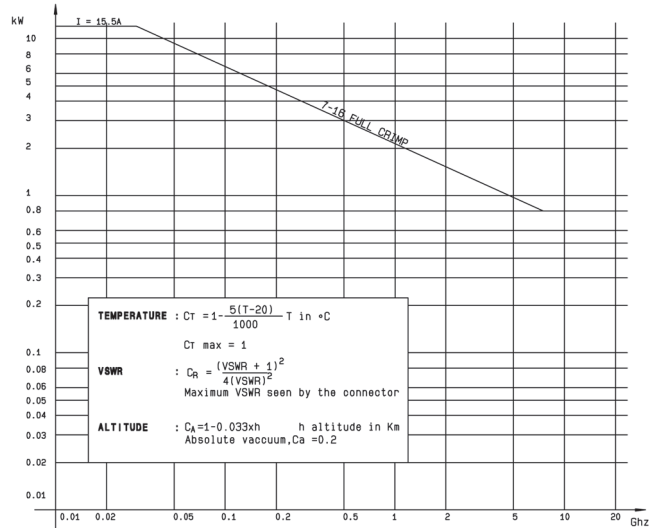

## CHARACTERISTICS COMPOSITE 7/16

### ELECTRICAL CHARACTERISTICS

Frequency range	DC-7.5 GHz
VSWR	1.06@DC-3 GHz - 1.10@DC-3-7.5 GHz
High working voltage	> 2700 V
Very low intermodulation	IMP3 < -125 dBm under 2 carriers of +43dBm And typically < -130 dBm
Power handling	> 800 W@ 935 MHz

### MECHANICAL CHARACTERISTICS

Longlife duration	up to 500 mating cycles
Coupling torque	35 Nm or less
Coupling strength	1000 N
Center contact retention / axial force	> 200 N
Center contact retention / torque	> 80 Ncm

### ENVIRONMENTAL CHARACTERISTICS

Temperature range	-40°C / +85°C
Humidity	Up to 100%@20°C
Flammability rating	UL94-V0
UV resistance	IEC 68-2-5/IEC 68-2-9
Waterproof	IP67

Some connectors may feature different performance depending on the application they have been designed for, or according to the applicable cable.



## STRAIGHT PLUGS, CRIMP AND CLAMP TYPE, FOR FLEXIBLE CABLES

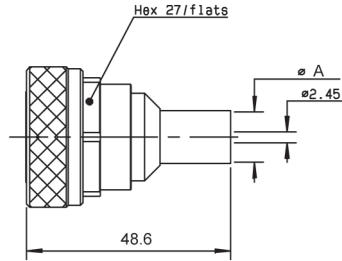
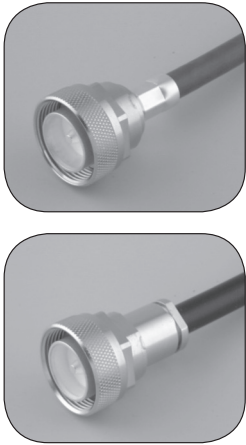

Fig. 1

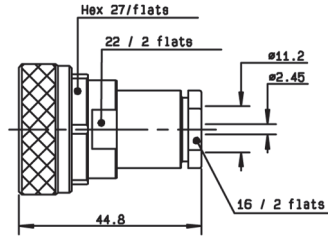

Fig. 2

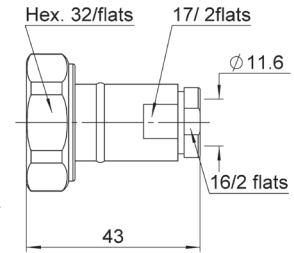

Fig. 3

Cable group	Cable group dia.	Part number	Fig.	Dimensions (mm)	Captive center contact	Finish	Note
				A			
RG213/RG393	10/50/S + D	R185 074 000	1	11.05	yes	Silver + BBR	Crimp type
RG214	11/50/D	R185 077 000		11.4			Clamp type
RG213/RG393/RG214	10 + 11/50/S + D	R185 010 000	3			BBR	Clamp type ECO version
		R185A 010 000					

## STRAIGHT PLUGS EZ FIT TYPE FOR CORRUGATED CABLES

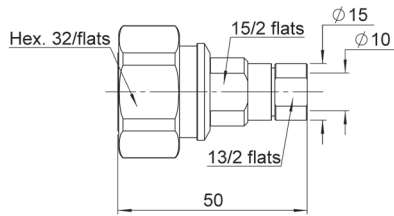

Fig. 1

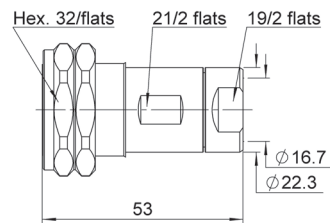

Fig. 2

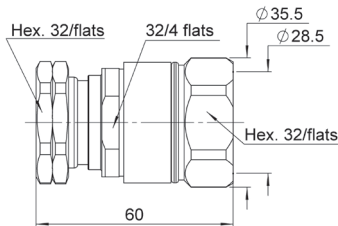

Fig. 3

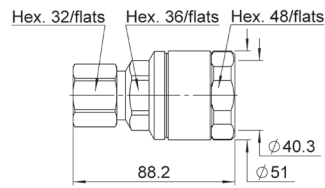

Fig. 4

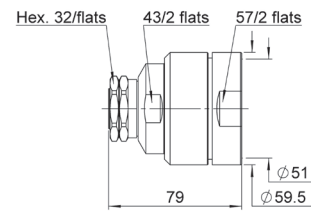

Fig. 5

Cable groupe dia.	Part number	Fig.	Captive center contact	Finish	Note
1/4" superflexible corrugated	R185A 030 200	1	yes	BBR	ECO version
1/2" flexible corrugated	R185A 031 020	2			
1/2" superflexible corrugated	R185A 031 200	2			
3/8" superflexible corrugated	R185A 032 200	1			
7/8" flexible corrugated	R185A 033 020	3			
1 1/4" flexible corrugated	R185A 035 020	4			
1 1/4" flexible corrugated	R185A 035 020	4			
1 5/8" flexible corrugated	R185A 037 020	5			

To download data sheets and assembly instructions, visit [www.radiall.com](http://www.radiall.com) & enter the part number in the Search box. **Bold** part numbers represent products typically in stock & available for immediate shipment. See page 8 and 9 for packaging information.

# RIGHT ANGLE PLUGS

## RIGHT ANGLE PLUGS CRIMP AND CLAMP TYPE FOR FLEXIBLE CABLES

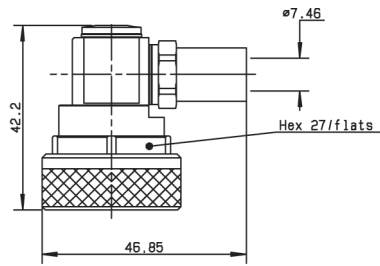

Fig. 1

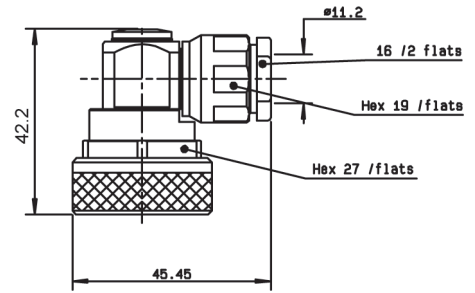

Fig. 2

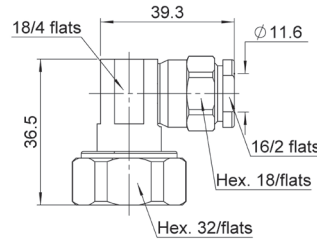

Fig. 3

Cable group	Cable group dia.	Part number	Fig.	Captive center contact	Finish	Note
RG213	10/50/S	R185 174 000	1	yes	Silver + BBR	Crimp type
		R185A 174 000	1			Crimp type ECO version
RG393/RG214	10+11/50/D	R185 160 000	2			Clamp type
		R185A 160 000	3			Clamp type ECO version

## RIGHT ANGLE PLUGS EZ FIT TYPE

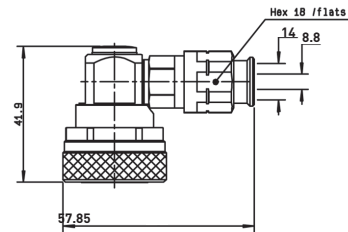

Fig. 1

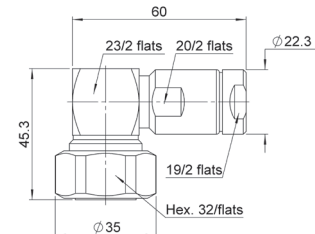

Fig. 2

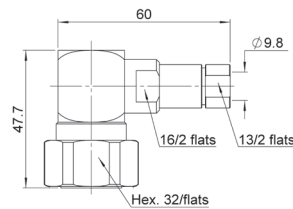

Fig. 3

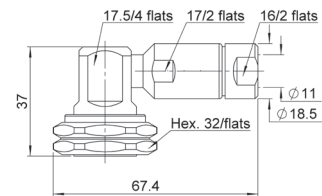

Fig. 4

Cable group dia.	Part number	Fig.	Captive center contact	Finish
1/2" superflexible corrugated	R185 165 200	1	yes	Silver + BBR
1/2" superflexible corrugated	R185A 165 200	2		Silver + BBR
1/4" superflexible corrugated	R185A 164 200	3		ECO version
3/8" superflexible corrugated	R185A 166 200	4		

# STRAIGHT AND SQUARE FLANGE JACKS

7/16

## STRAIGHT JACKS

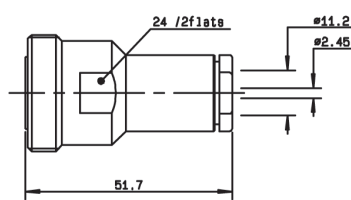

Fig. 1

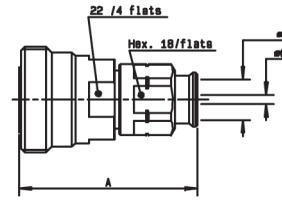

Fig. 2

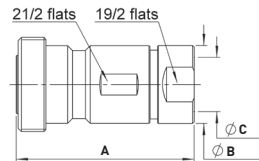

Fig. 3

Cable group	Cable group dia.	Part number	Fig.	Dimensions (mm)			Captive center contact	Finish	Note
				A	B	C			
RG393/RG214	10 + 11/50 D	R185 210 000	1				yes	Silver + BBR	clamp type
	1/4" superflexible corrugated	R185 215 200	2	49.45	7.95	4.7			
	1/2" superflexible corrugated	R185 216 200		50	14	8.8			
	3/8" superflexible corrugated	R185 217 200	3		11	7.1			
	1/2" flexible corrugated	R185A 216 020		54.5	22.3	16.7			
	7/8" flexible corrugated	R185A 218 020		55.5	35.5	28.5			
	1 1/4" flexible corrugated	R185A 220 020		65.5	49	40.2			
	1 5/8" flexible corrugated	R185A 222 020		76.5	59.5	51			Ez fit type ECO version

## STRAIGHT SQUARE FLANGE JACKS

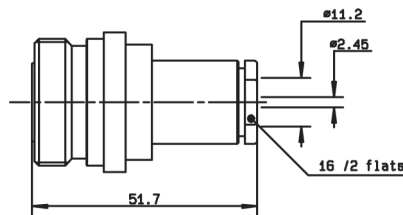

Fig. 1

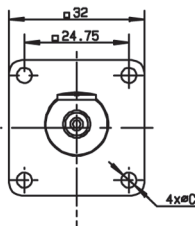
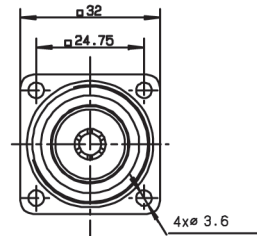
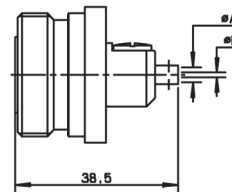

Fig. 2



Cable group	Cable group dia.	Part number	Fig.	Captive center contact	Dimensions (mm)			Panel drilling	Finish	Note
					A	B	C			
RG393/RG214	10 + 11/50 D	R185 260 000	1	yes				P01		Clamp type for flexible cables
RG402	.141"	R185 252 000	2	yes	3.65	0.996	3.6	P01	Silver + BBR	Solder type for semi-rigid cables
RG401	.250"	R185A 254 000		yes	6.45	1.68	3.6			

To download data sheets and assembly instructions, visit [www.radiall.com](http://www.radiall.com) & enter the part number in the Search box.  
**Bold** part numbers represent products typically in stock & available for immediate shipment.  
 See page 8 and 9 for packaging information.

13-11

# BULKHEAD JACKS AND RECEPTACLES

## STRAIGHT BULKHEAD JACKS FOR FLEXIBLE CABLES AND CORRUGATED CABLES

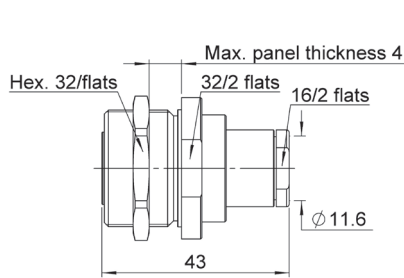
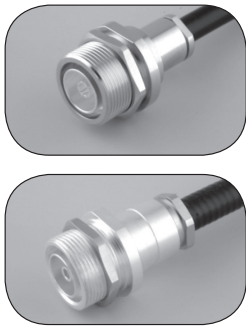

Fig. 1

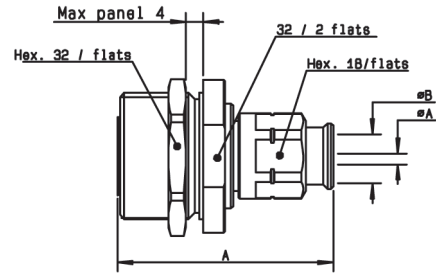

Fig. 2

Cable group	Cable group dia.	Part number	Fig.	Captive center contact	Panel drilling	Finish	Note
RG213/RG216/ Eco393/RG214	10+11/S+D	R185A 310 000	1	yes	P02	Silver + BBR	Clamp type for flexible cables ECO version
1/4" superflexible corrugated	R185A 315 200	2	EZ FIT type for corrugated cables ECO version				
1/2" superflexible corrugated	R185A 316 200						
3/8" superflexible corrugated	R185A 317 200						

## STRAIGHT FLANGE FEMALE RECEPTACLES

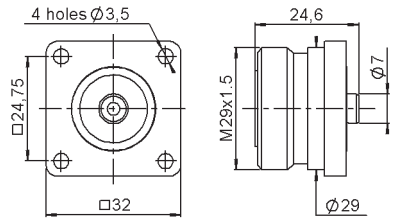
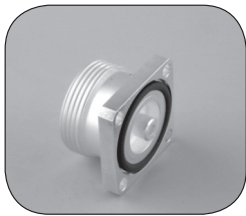

Fig. 1

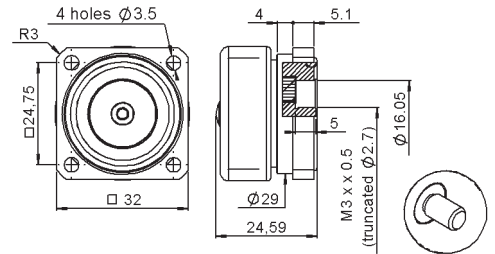

Fig. 2

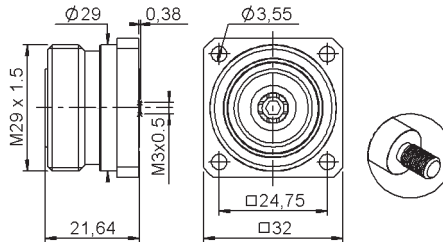

Fig. 3

Part number	Fig.	Captive center contact	Panel drilling	Finish	Slotted outer contact	Packaging	Note
R185 403 547	1	yes	P03	BBR	no	20	With solder pot contact
R185 405 200	2		P05	Silver + Copper	yes		Panel seal flange mount
R185 406 090	3			BBR	no	50	M3

To download data sheets and assembly instructions, visit [www.radiall.com](http://www.radiall.com) & enter the part number in the Search box. **Bold** part numbers represent products typically in stock & available for immediate shipment. See page 8 and 9 for packaging information.

## IN SERIES ADAPTERS

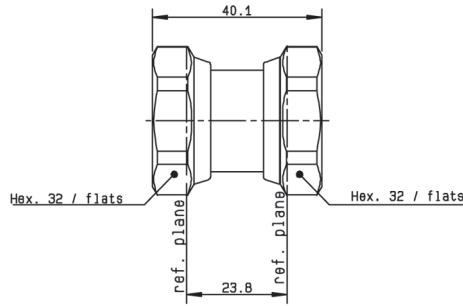

Fig. 1

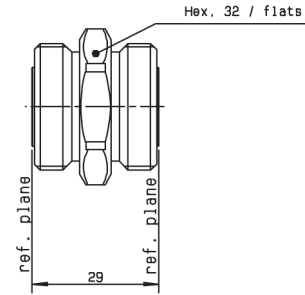

Fig. 2

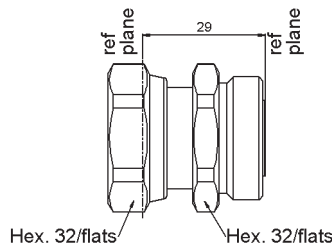

Fig. 3

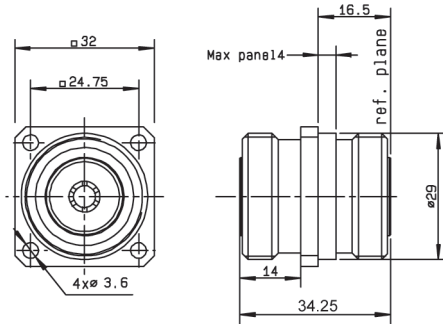

Fig. 4

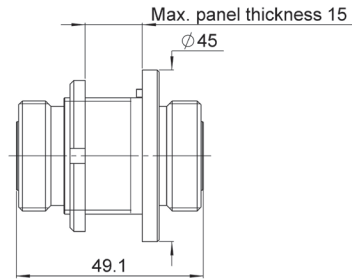

Fig. 5

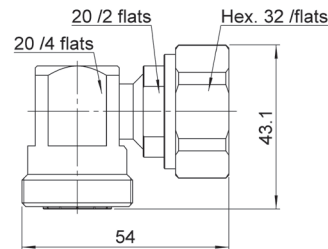

Fig. 6

Part number	Fig.	Captive center contact	Panel drilling	Finish	Note
R185 703 000	1	yes		Silver + Copper	male - male
R185 705 000	2				female - female
R185 707 000	3				male - female
R185 710 000	4		P01	female - female flange mount	
R185 730 020	5		P06	Silver + BBR	female - female
R185A 770 000	6			BBR	ECO version

To download data sheets and assembly instructions, visit [www.radiall.com](http://www.radiall.com) & enter the part number in the Search box. **Bold** part numbers represent products typically in stock & available for immediate shipment. See page 8 and 9 for packaging information.

JACKS AND PLUGS

STRAIGHT BULKHEAD JACKS PANEL SEAL

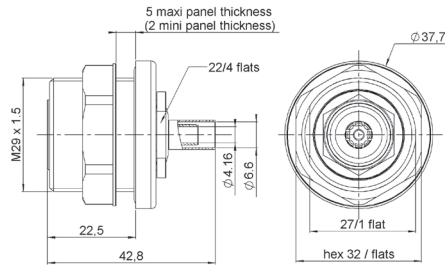

Fig. 1

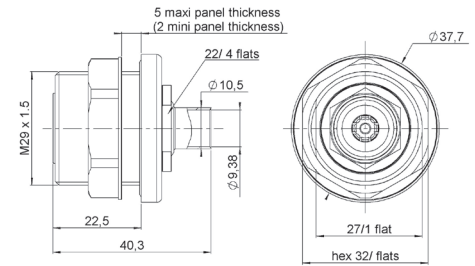

Fig. 2

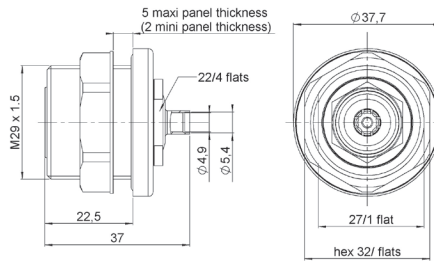

Fig. 3

Cable group	Cable group dia.	Part number	Fig.	Panel drilling	Note
ECO230	6/50/D	R187 100 000	1	P07	Crimp type
	3/8" superflexible corrugated	R187 110 010	2	P07	Solder type
	SHF 5LI	R187 110 020	3	P07	Solder type

RIGHT ANGLE PLUGS

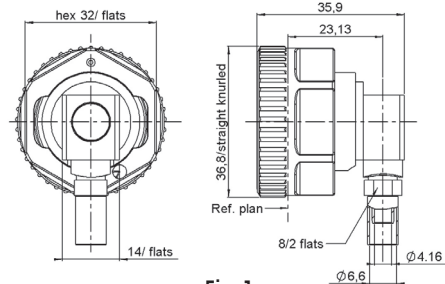
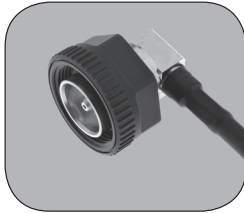

Fig. 1

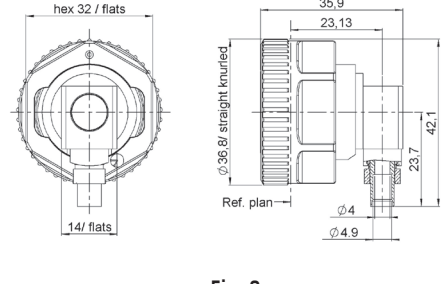

Fig. 2

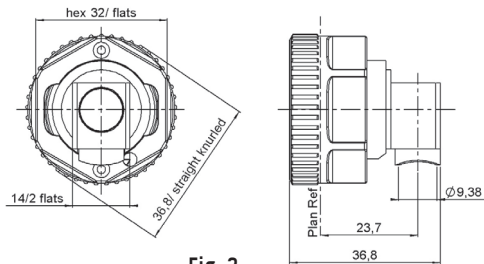

Fig. 3

Cable group	Cable group dia.	Part number	Fig.	Note
ECO230	6/50/D	R187 700 200	1	Crimp type
	SHF 5LI	R187 710 200	2	Solder type
	3/8" superflexible corrugated	R187 710 210	3	Solder type

To download data sheets and assembly instructions, visit [www.radiall.com](http://www.radiall.com) & enter the part number in the Search box. **Bold** part numbers represent products typically in stock & available for immediate shipment. See page 8 and 9 for packaging information.

## SQUARE FLANGE JACK RECEPTACLE SOLDER TYPE, PANEL SEAL

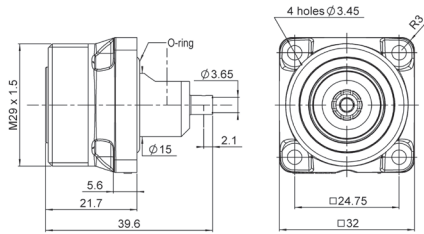

Fig. 1

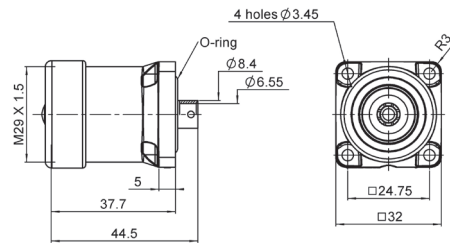

Fig. 2

Cable group	Cable group dia.	Part number	Fig.	Panel drilling
RG402	.141"	R187 403 010	1	P08
RG401	.250"	R187 130 000	2	P08

## SQUARE FLANGE JACK RECEPTACLE PANEL SEAL

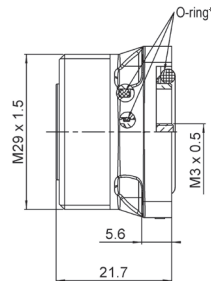
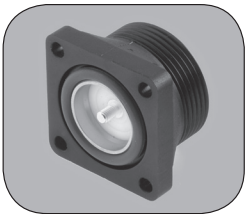

Fig. 1

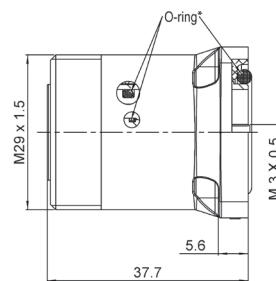

Fig. 2

Part number	Fig.	Captive center contact	Waterproof interface	Color	Panel drilling
R187 403 000	1	no	no	black	P08
R187 403 100			yes		
R187 406 000		yes	no		
R187 406 100			yes		
R187 413 000	2	no	no		
R187 413 100			yes		
R187 416 000		yes	no		
R187 416 100			yes		

Standard color is black however, other colors are proposed upon request. Packaging 20 pieces.

Other specific demands can be proceeded according to customer needs.

\* O-ring inside, only on the waterproof models.

To download data sheets and assembly instructions, visit [www.radiall.com](http://www.radiall.com) & enter the part number in the Search box. **Bold** part numbers represent products typically in stock & available for immediate shipment. See page 8 and 9 for packaging information.

**PANEL DRILLING**

**P01**

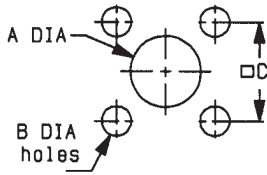

	MM		INCH	
	maxi	mini	maxi	mini
A	29.2	29.1	1.15	1.146
B	3.7	3.6	0.146	0.142
C	24.8	24.7	0.976	0.972

**P02**

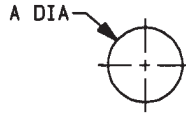

	MM		INCH	
	maxi	mini	maxi	mini
A	29.2	29.1	1.15	1.146

**P03**

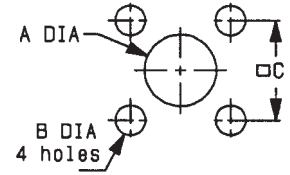

	MM		INCH	
	maxi	mini	maxi	mini
A (R. Mount)	16.2	16	0.638	0.63
A (F. Mount)	29.3	29.1	1.154	1.146
B	3.7	3.6	0.146	0.142
C	24.8	24.7	0.976	0.972

**P04**

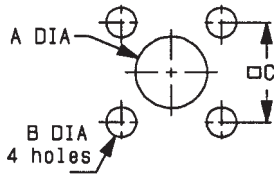

	MM		INCH	
	maxi	mini	maxi	mini
A	12.3	12.1	0.484	0.476
B	3.8	3.7	0.15	0.146
C	24.8	24.7	0.976	0.972

**P05**

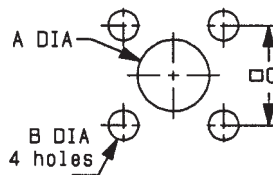

	MM		INCH	
	maxi	mini	maxi	mini
A	16.2	16	0.638	0.63
B	3.7	3.6	0.146	0.142
C	24.8	24.7	0.976	0.972

**P06**

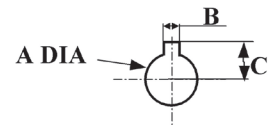

	mm	
	Maxi	mini
A	30.55	30.45
B	3.3	3.2
C	17.6	17.5

**P07**

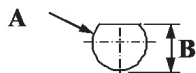

	mm	
	Maxi	mini
A	29.4	29.2
B	27.5	27.3

**P08**

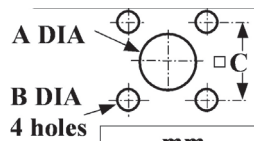

	mm	
	Maxi	mini
A	16.2	16
B	3.7	3.6
C	24.8	24.7





AEROSPACE



AUTOMOTIVE



DEFENSE



INDUSTRIAL



INSTRUMENTATION



MEDICAL



SPACE



TELECOM

## EUROPE

### France - RADIALL S.A.

101, Rue Ph. Hoffmann  
93116 ROSNY sous BOIS (Paris)  
Tel.: +33 1 49 35 35 35 - Fax: +33 1 48 54 63 63  
E-Mail: info@radiall.com

### Finland - RADIALL SF

P.O. Box 202 - 90101 OULU  
Tel.: +358 407 522 412  
E-Mail: infofi@radiall.com

### Germany - RADIALL GmbH

Carl-Zeiss Str. 10 Postfach 200143  
D63307 - RÖDERMARK (Frankfurt)  
Tel.: +49 60 74 91 07 0 - Fax: +49 60 74 91 07 70  
E-Mail: infode@radiall.com

### Italy - RADIALL Elettronica S.R.L.

Via Concordia, 5 - 20090 ASSAGO MILANO  
Tel.: +39 02 48 85 121 - Fax: +39 02 48 84 30 18  
E-Mail: infoit@radiall.com  
Regional office: Roma

### Netherlands - RADIALL B.V.

Hogebrinkerweg 15b - 3871 KM HOEVELAKEN  
Tel.: +31 33 253 40 09 - Fax: +31 33 253 45 12  
E-Mail: infofl@radiall.com

### Sweden - RADIALL A.B.

Sjöängsvägen 2 - SE-192 72 SOLLENTUNA (Stockholm)  
Tel.: +46 844 434 10 - Fax: +46 875 449 16  
E-Mail: infose@radiall.com

### U.K. - RADIALL Ltd.

Ground Floor, 6 The Grand Union Office Park,  
Packet Boat Lane  
UXBRIDGE Middlesex UB8 2GH (London)  
Tel.: +44 1895 425 000 - Fax: +44 1895 425 010  
E-Mail: infouk@radiall.com

## NORTH AMERICA

### USA - RADIALL USA, Inc.

6825 West Galveston Street  
CHANDLER, Arizona 85226  
Tel.: +1 480 682 9400 - Fax: +1 480 682 9403  
E-Mail: infousa@radiall.com

## ASIA

### China - SHANGHAI RADIALL Electronic Co., Ltd.

N° 390 Yong He Road 200072 - SHANGHAI  
Tel.: +86 21 66 52 37 88 - Fax: +86 21 66 52 11 77  
E-Mail: infoch@radiall.com

### Japan - NIHON RADIALL

Shibuya-ku Ebisu 1-5-2, Kougetsu Bldg 405  
TOKYO 150-0013  
Tel.: +81 3 3440 6241 - Fax: +81 3 3440 6242  
E-Mail: infojp@radiall.com

### Hong Kong - RADIALL Electronics Ltd.

Flat D, 6/F, Ford Glory Plaza,  
37-39 Wing Hong Street  
Cheung Sha Wan  
KOWLOON HONG KONG  
Tel: +852-2959-3833 - Fax: +852-2959-2636  
E-Mail: infohk@radiall.com

### India - RADIALL India Pvt. Ltd.

25 D, II Phase, Peenya Industrial Area  
BANGALORE 560058  
Tel.: +91 80 83 95 271 - Fax: +91 80 83 97 228  
E-Mail: infoin@radiall.com

## ALSO REPRESENTED IN

Australia	Hungary	Poland
Austria	Indonesia	Russia
Belgium	Israel	Singapore
Brazil	Korea	Spain
Czech Republic	Latvia	Switzerland
Denmark	Lithuania	Taiwan
Estonia	Malaysia	Thailand
Greece	Norway	Vietnam
	Philippines	South Africa

For the above countries, please contact the local agent or RADIALL at info@radiall.com

Компания «Океан Электроники» предлагает заключение долгосрочных отношений при поставках импортных электронных компонентов на взаимовыгодных условиях!

Наши преимущества:

- Поставка оригинальных импортных электронных компонентов напрямую с производств Америки, Европы и Азии, а так же с крупнейших складов мира;
- Широкая линейка поставок активных и пассивных импортных электронных компонентов (более 30 млн. наименований);
- Поставка сложных, дефицитных, либо снятых с производства позиций;
- Оперативные сроки поставки под заказ (от 5 рабочих дней);
- Экспресс доставка в любую точку России;
- Помощь Конструкторского Отдела и консультации квалифицированных инженеров;
- Техническая поддержка проекта, помощь в подборе аналогов, поставка прототипов;
- Поставка электронных компонентов под контролем ВП;
- Система менеджмента качества сертифицирована по Международному стандарту ISO 9001;
- При необходимости вся продукция военного и аэрокосмического назначения проходит испытания и сертификацию в лаборатории (по согласованию с заказчиком);
- Поставка специализированных компонентов военного и аэрокосмического уровня качества (Xilinx, Altera, Analog Devices, Intersil, Interpoint, Microsemi, Actel, Aeroflex, Peregrine, VPT, Syfer, Eurofarad, Texas Instruments, MS Kennedy, Miteq, Cobham, E2V, MA-COM, Hittite, Mini-Circuits, General Dynamics и др.);

Компания «Океан Электроники» является официальным дистрибьютором и эксклюзивным представителем в России одного из крупнейших производителей разъемов военного и аэрокосмического назначения «**JONHON**», а так же официальным дистрибьютором и эксклюзивным представителем в России производителя высокотехнологичных и надежных решений для передачи СВЧ сигналов «**FORSTAR**».



## JONHON

«**JONHON**» (основан в 1970 г.)

Разъемы специального, военного и аэрокосмического назначения:

(Применяются в военной, авиационной, аэрокосмической, морской, железнодорожной, горно- и нефтедобывающей отраслях промышленности)

«**FORSTAR**» (основан в 1998 г.)

ВЧ соединители, коаксиальные кабели, кабельные сборки и микроволновые компоненты:

(Применяются в телекоммуникациях гражданского и специального назначения, в средствах связи, РЛС, а так же военной, авиационной и аэрокосмической отраслях промышленности).



Телефон: 8 (812) 309-75-97 (многоканальный)

Факс: 8 (812) 320-03-32

Электронная почта: [ocean@oceanchips.ru](mailto:ocean@oceanchips.ru)

Web: <http://oceanchips.ru/>

Адрес: 198099, г. Санкт-Петербург, ул. Калинина, д. 2, корп. 4, лит. А