

Amphenol Pcd



75P CLAMP

Description:

Engineered for lean manufacturing and high performance, the 75P Clamp was designed as a one-for-one replacement to outperform industry standard metal clamps (i.e. AS21919). Featuring benefits such as a locking feature, butterfly stacking, weight savings, durable PEEK polymer band material and multiple cushion material options that are non-conductive and non-corrosive, the 75P Clamp is a versatile solution for anyone looking to reduce weight and installation time.

Specifications

Materials

Band: PEEK per Mil-P-46183 Type I

Cushion: See Cushion Material Codes on next pg.

Environmental

Operating Temperature: -55°C to 70°C

Temperature Variation per RTCA DO-160G, Category A: -55°C to 85°C at 10°C/min

Humidity per RTCA DO-160G, Category B: 240h at 38°C/85%RH to 65°C/95%RH

Mechanical

Operational Shock and Crash Safety as per RTCA DO-160G, Category B: 6g Shock, 20g Crash Safety

Vibration per RTCA DO-160G: Random Vibration, Curve E1, 11grms & High Level, Short Duration, Curve P, ±10g sinusoidal from 10 to 250Hz

Static Load: All sizes exceed 50lbf load at -55°C, 23°C, and 70°C

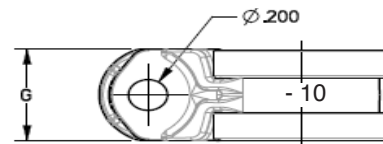

Part Number Callout

ALBPCL75P	10	E
-----------	----	---

Basic Part Number

Dash Size

Cushion Material Code

75P CLAMP

General Dimensions

Part Number	Dash #	ØD		E		F		G		T		S		Weight	
		Inch	mm	Inch	mm	Inch	mm	Inch	mm	Inch	mm	Inch	mm	lbs.	grams
ALBPCL75P02X	-02	.125	3.18	.477	12.12	.160	4.06	.600	15.24	.030	.76	.040	1.02	.0043	1.95
ALBPCL75P03X	-03	.188	4.78	.518	13.16	.180	4.57			.035	.89			.0052	2.36
ALBPCL75P04X	-04	.250	6.35	.549	13.94					.0064	2.90				
ALBPCL75P05X	-05	.313	7.95	.580	14.73	.200	5.08			.040	1.02			.0073	3.31
ALBPCL75P06X	-06	.375	9.53	.612	15.54									.0081	3.67
ALBPCL75P07X	-07	.438	11.13	.643	16.33	.240	6.10			.050	1.27			.0089	4.04
ALBPCL75P08X	-08	.500	12.70	.674	17.12									.0097	4.40
ALBPCL75P09X	-09	.563	14.30	.752	19.10	.280	7.11			.060	1.52			.0118	5.35
ALBPCL75P10X	-10	.625	15.88	.783	19.89									.0126	5.72
ALBPCL75P11X	-11	.688	17.48	.834	21.18	.320	8.13			.070	1.78			.060	1.52
ALBPCL75P12X	-12	.750	19.05	.865	21.97			.0166	7.53						
ALBPCL75P13X	-13	.813	20.65	.897	22.78	.360	9.14	.060	1.52	.0186	8.44				
ALBPCL75P14X	-14	.875	22.23	.928	23.57					.0196	8.89				
ALBPCL75P15X	-15	.938	23.83	.959	24.36					.0208	9.43				
ALBPCL75P16X	-16	1.000	25.40	.990	25.15					.0218	9.89				
ALBPCL75P17X	-17	1.063	27.00	1.022	25.96	.375	9.53	.070	1.78	.0229	10.39				
ALBPCL75P18X	-18	1.125	28.58	1.082	27.48					.0245	11.11				
ALBPCL75P19X	-19	1.188	30.18	1.113	28.27					.0275	12.47				
ALBPCL75P20X	-20	1.250	31.75	1.144	29.06					.0286	12.97				
ALBPCL75P21X	-21	1.313	33.35	1.176	29.87	.400	10.16	.080	2.03	.0297	13.47				
ALBPCL75P22X	-22	1.375	34.93	1.207	30.66					.0326	14.79				
ALBPCL75P23X	-23	1.438	36.53	1.238	31.45					.0337	15.29				
ALBPCL75P24X	-24	1.500	38.10	1.269	32.23					.0349	15.83				

Cushion Materials

Cushions for the 75P Clamp are available in a wide variety of rubber materials, including Ethylene Propylene, Nitrile, Chloroprene, Silicone, and Fluorosilicone. Cushion profile, materials, and color-coding are the same as metal clamps for maximum compatibility with any current application and environment.

				
EPR (E)	Nitrile (N)	Chloroprene (G)	Silicone (S)	Fluorosilicone (J)

75P Clamp Diagram



Cushion Material Codes

Code	Material	Color	Application
E	Ethylene Propylene per AMS 3253	Purple	For use in areas exposed to phosphate ester hydraulic fluid (Skydrol). Excellent ozone resistance. Not resistant to petroleum-based fluids.
N	Nitrile per AMS 3224	Yellow	For use primarily in fuel immersion and with fuel vapors. Good ozone resistance. Not resistant to phosphate ester based fluids. Not for use on titanium tubing.
G	Chloroprene per AMS 3209	Black with Blue Stripe	For general use in areas exposed to petroleum based hydraulic fluids and occasional fuel splash. Excellent ozone resistance. Not resistant to phosphate ester based fluids. Not for use on titanium tubing.
S	Silicone per AMS 3310	White	For elevated temperature usage in areas exposed to phosphate ester and other synthetic fluids. Unaffected by ozone. Not resistant to petroleum based fluids.
J	Fluorosilicone per Mil-R-25988 Type II, Class 1, Grade 60	Blue	For elevated temperature usage in areas exposed to petroleum based fluids. Unaffected by ozone. Not resistant to phosphate ester based fluids.

One-Handed Installation

The 75P Clamp is built with ease of installation and ergonomics in mind featuring interlocking legs and a snapping pre-lock. The interlocking legs ensure that the mounting holes always stay in perfect alignment while a pre-lock feature snaps the clamp into a closed position. With these two features, a one-handed installation is made possible, which benefits installers in obstructed access areas.



AS21919

The labor intensive installation process for metal clamps requires two hands to physically bend and shape the clamp both open and closed around the bundle. The reshaping of the clamp often leads to misalignment of mounting holes, making it difficult to hold the clamp in a closed position and install a fastener at the same time. This contributes to repetitive stress injury.



75P Clamp Series

- Using flexible yet strong PEEK material the 75P Clamp is easily placed around the wire bundle while still retaining optimal shape.
- The interlocking legs and pre-lock allow installers to simply pinch and snap the clamp into a closed position around the bundle. The pinching force falls within recommended limits to prevent repetitive use injury.
- With the clamp already held in a closed position and mounting holes pre-aligned by the snapping pre-lock, installers have both hands free to insert fasteners and mount the clamp to the structure.

75P Clamp vs CRES & Alum

Size	AS21919				ALBPCL75P		% Weight Savings	
	CRES		Alum		75P Clamp		vs. CRES	vs. Alum
	lbs.	grams	lbs.	grams	lbs.	grams		
-02	.008	3.63	.005	2.27	.004	1.81	-46%	-14%
-03	.010	4.54	.006	2.72	.005	2.27	-48%	-13%
-04	.011	4.99	.007	3.18	.006	2.72	-42%	-9%
-05	.012	5.44	.008	3.63	.007	3.18	-39%	-9%
-06	.014	6.35	.009	4.08	.008	3.63	-42%	-10%
-07	.016	7.26	.010	4.54	.009	4.08	-44%	-11%
-08	.018	8.16	.010	4.80	.010	4.54	-46%	-3%
-09	.022	9.98	.013	5.90	.012	5.44	-46%	-9%
-10	.027	12.25	.016	7.26	.013	5.90	-53%	-21%
-11	.029	13.15	.019	8.62	.016	7.26	-46%	-18%
-12	.031	14.06	.021	9.53	.017	7.71	-46%	-21%
-13	.033	14.97	.022	9.98	.019	8.62	-44%	-15%
-14	.035	15.88	.023	10.43	.020	9.07	-44%	-15%
-15	.037	16.78	.025	11.34	.021	9.53	-44%	-17%
-16	.039	17.69	.027	12.25	.022	9.98	-44%	-19%
-17	.043	19.50	.030	13.61	.023	10.43	-47%	-24%
-18	.046	20.87	.032	14.51	.025	11.34	-47%	-23%
-19	.049	22.23	.034	15.42	.028	12.70	-44%	-19%
-20	.052	23.59	.036	16.33	.029	13.15	-45%	-21%
-21	.055	24.95	.038	17.24	.030	13.61	-46%	-22%
-22	.058	26.31	.039	17.69	.033	14.97	-44%	-16%
-23	.061	27.67	.041	18.60	.034	15.42	-45%	-18%
-24	.063	28.58	.043	19.50	.035	15.88	-45%	-19%



75P Clamp



AS21919

AMPHENOL PCD PRODUCTS



BACKSHELLS



CABLE SOLUTIONS



CIRCULAR



GROUND BLOCKS



LUMINUS



MILITARY AUDIO/POWER



PEGASUS SERIES



RECTANGULAR



RUGGED SOLUTIONS



SIM



SOLARIS



SYSTEM ATTACHMENTS

Amphenol Pcd

www.amphenolpcd.com

U.S. PATENT NOTICE

The product specialized in this brochure is covered by U.S. Patent UA9.829.119B2

Компания «Океан Электроники» предлагает заключение долгосрочных отношений при поставках импортных электронных компонентов на взаимовыгодных условиях!

Наши преимущества:

- Поставка оригинальных импортных электронных компонентов напрямую с производств Америки, Европы и Азии, а так же с крупнейших складов мира;
- Широкая линейка поставок активных и пассивных импортных электронных компонентов (более 30 млн. наименований);
- Поставка сложных, дефицитных, либо снятых с производства позиций;
- Оперативные сроки поставки под заказ (от 5 рабочих дней);
- Экспресс доставка в любую точку России;
- Помощь Конструкторского Отдела и консультации квалифицированных инженеров;
- Техническая поддержка проекта, помощь в подборе аналогов, поставка прототипов;
- Поставка электронных компонентов под контролем ВП;
- Система менеджмента качества сертифицирована по Международному стандарту ISO 9001;
- При необходимости вся продукция военного и аэрокосмического назначения проходит испытания и сертификацию в лаборатории (по согласованию с заказчиком);
- Поставка специализированных компонентов военного и аэрокосмического уровня качества (Xilinx, Altera, Analog Devices, Intersil, Interpoint, Microsemi, Actel, Aeroflex, Peregrine, VPT, Syfer, Eurofarad, Texas Instruments, MS Kennedy, Miteq, Cobham, E2V, MA-COM, Hittite, Mini-Circuits, General Dynamics и др.);

Компания «Океан Электроники» является официальным дистрибьютором и эксклюзивным представителем в России одного из крупнейших производителей разъемов военного и аэрокосмического назначения «JONHON», а так же официальным дистрибьютором и эксклюзивным представителем в России производителя высокотехнологичных и надежных решений для передачи СВЧ сигналов «FORSTAR».



JONHON

«JONHON» (основан в 1970 г.)

Разъемы специального, военного и аэрокосмического назначения:

(Применяются в военной, авиационной, аэрокосмической, морской, железнодорожной, горно- и нефтедобывающей отраслях промышленности)

«FORSTAR» (основан в 1998 г.)

ВЧ соединители, коаксиальные кабели, кабельные сборки и микроволновые компоненты:

(Применяются в телекоммуникациях гражданского и специального назначения, в средствах связи, РЛС, а так же военной, авиационной и аэрокосмической отраслях промышленности).



Телефон: 8 (812) 309-75-97 (многоканальный)

Факс: 8 (812) 320-03-32

Электронная почта: ocean@oceanchips.ru

Web: <http://oceanchips.ru/>

Адрес: 198099, г. Санкт-Петербург, ул. Калинина, д. 2, корп. 4, лит. А