

PT Medium voltage fuses for potential and small power transformers



Description:

- Bussmann® series Indicating and non-indicating E-Rated, current-limiting, medium voltage fuses for potential, small power and control transformers.

Contents

Description	Page
Introduction	2
2.475kV fuses	3-6
3.6kV fuses	7-9
5.5kV fuses	10-26
7.2kV fuses	27-29
8.3kV fuses	30-39
12kV fuses	40-42
15.5kV fuses	43-52
17.5kV fuses	53-54
24kV fuses	55-56
25.5kV fuses	57-60
36kV fuses	61-62
38kV fuses	63-69
Fuse mountings	70-71

Features and benefits

- Low amp, current-limiting E-Rated PT medium voltage fuses are general purpose fuses defined by their melting time-current characteristic that permit their electrical interchangeability with other fuses of the same E Rating.
- E-Rated general purpose fuses must have a current responsive element that will melt in 300 seconds at an RMS current within the range of 200% to 240% of the fuse's nameplate current rating, fuse refill, or link per ANSI C37.46 for fuses rated 100E or less.
- PT fuses are physically dimensioned for easy installation in existing hardware.
- Space saving size eases design considerations for new installations.
- Current-limiting fuses provide positive interruption even on low fault currents. The fuse limits the magnitude of electromechanical stresses in the protected apparatus.
- These fuses are in a self-contained, non-venting package for installation indoors or outdoors in an enclosure.
- Available in indicating and non-indicating versions.
- Open fuse indicator speeds troubleshooting by providing a positive visual indication of fuse operation.

Typical applications:

- Primary protection of:
 - Medium voltage potential transformers
 - Small medium voltage service transformers
 - Small medium voltage control transformers.

E-Rated PT medium voltage fuses

Catalog symbols (by maximum voltage rating):

- 2.475kV
 - 2NCLPT_
- 3.6kV
 - 3.6ABCNA_
 - 3.6ABWNA_
 - 3.6CAV_
- 5.5kV
 - JCW_
 - 5CLPT_E
 - 5NCLPT_E
 - 5NCLPT_E-A
 - 5.5ABWNA_E
 - 5.5AMWNA_E
 - 5.5CAV_E
 - 5.5CAVH_E
- 7.2kV
 - 7.2ABWNA_
 - 7.2ABCNA_
 - 7.2AMWNA_E
 - 7.2CAV_
- 8.3kV
 - 8CLPT_E-A
 - 8CLPT_E-B
 - 8NCLPT_E
 - 8NCLPT_E-A
 - 8NCLPT_E-B
- 12kV
 - 12ABCNA_
 - 12CAV_
- 15.5kV
 - 15CLPT_E
 - 15NCLPT_E-A
 - 15NCLPT_E-B
 - 15.5CAV_E
 - 15.5CAVH_E
- 17.5kV
 - 17.5ABGNA_
 - 17.5CAV_
- 24kV
 - 24ABGNA_
 - 24CAV_
- 25.5kV
 - 25CLPT_E
- 36kV
 - 36ABGNA_
 - 36CAV_
- 38kV
 - 38CAV_E
 - 38CAVH_E
 - 38CLPT_E

Ratings*:

- Volts
 - 2.4kV to 38kV
- Amps
 - 0.25 to 15A
- Interrupting ratings
 - 25 to 80kA RMS Sym

* See catalog number tables for voltages, ampacities and interrupting ratings by catalog number.

Agency information:

- Those PT fuses conforming to the requirements for E-Rating meet the performance characteristics of ANSI C37.46

2.475kV maximum system voltage

Amp rating	Dimensions - in (mm)			Catalog No. (Interrupting rating - kA)		Recommended fuseclip
	Length A	Diameter B	Clip centers C	Indicating	Non-indicating	
0.25				—	2NCLPT-.25E (63)	
0.5				—	2NCLPT-.5E (63)	
1	4.5 (114)	0.8 (20)	3.9 (99)	—	2NCLPT-1E (40)	1A1837
2				—	2NCLPT-2E (40)	
5				—	2NCLPT-5E (25)	

Dimensions (see catalog number tables for values)

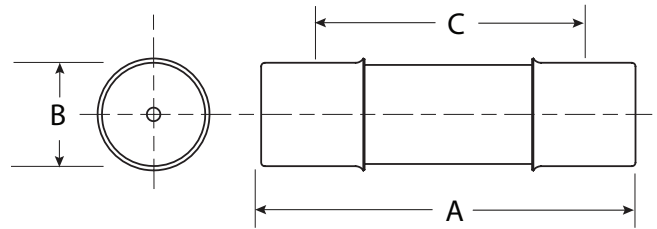

Recommended fuseclip and fuse block:

Description	Cat. No.
Open fuseclip for 0.8 (20mm) dia. fuses	1A1837
Single-pole open fuse block with #10-32 phil-slot screw terminals rated 2500V, 5A maximum and 63kA withstand rating	PTFB-2500-JCD

2.47kV time-current curves — minimum melting for 2NCLPT_E

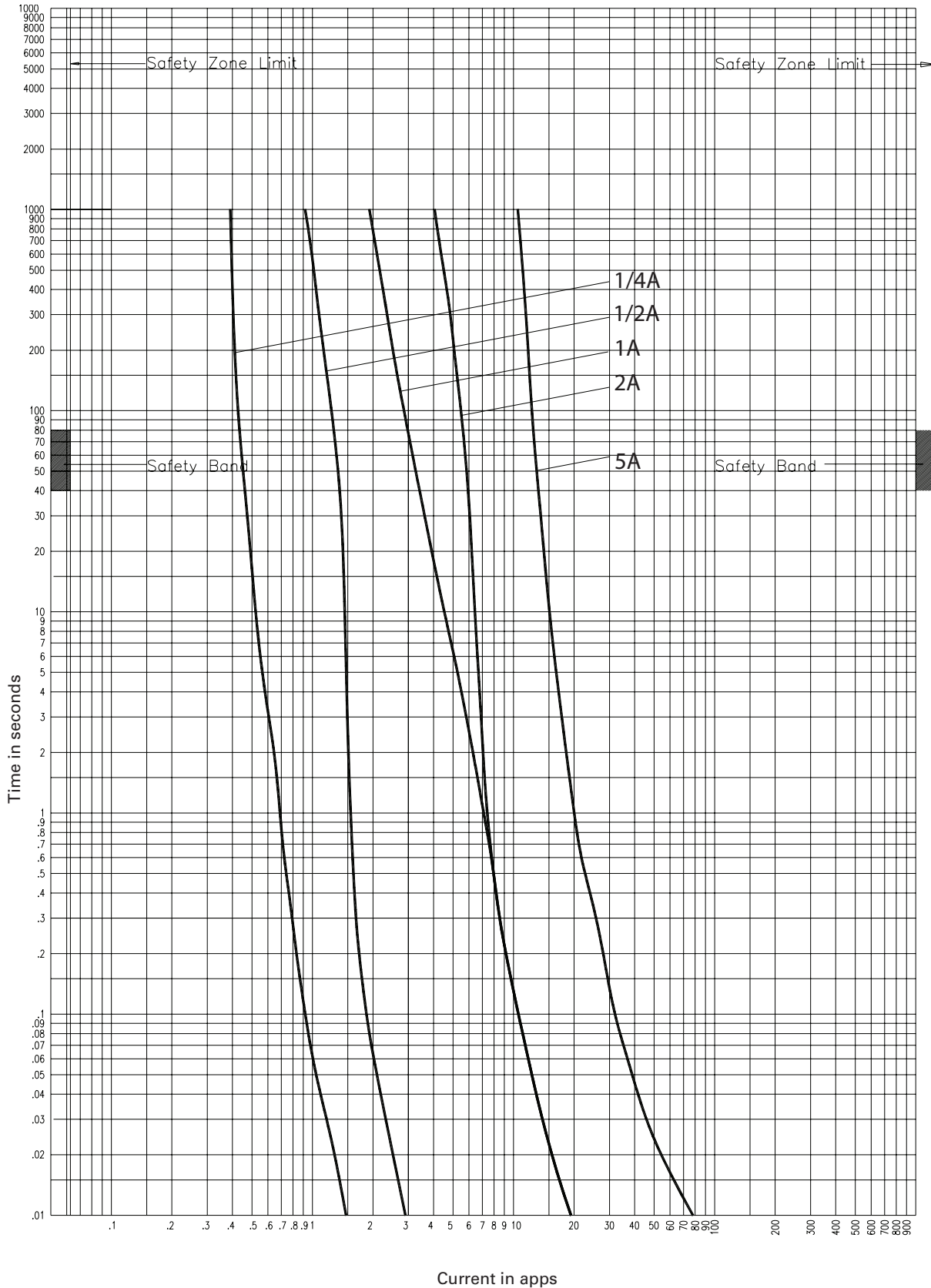

2NCLPT_E

CURVE 56357202
July 2002
Reference # 563572

2.47kV time-current curves — total clearing for 2NCLPT-E

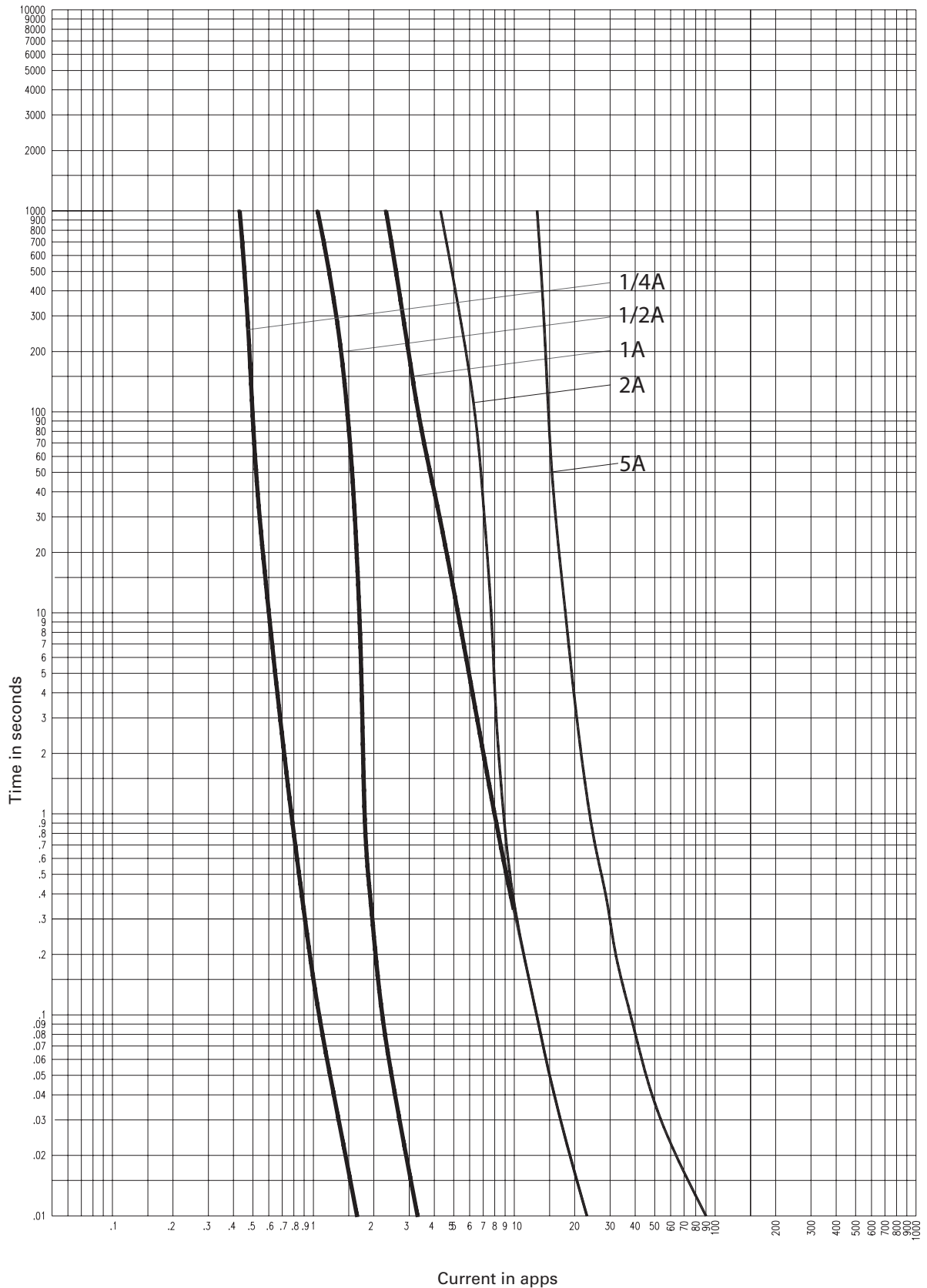

2NCLPT-E

CURVE 59883702
July 2002
Reference # 598837

2.47kV peak let-through curves for 2NCLPT_E

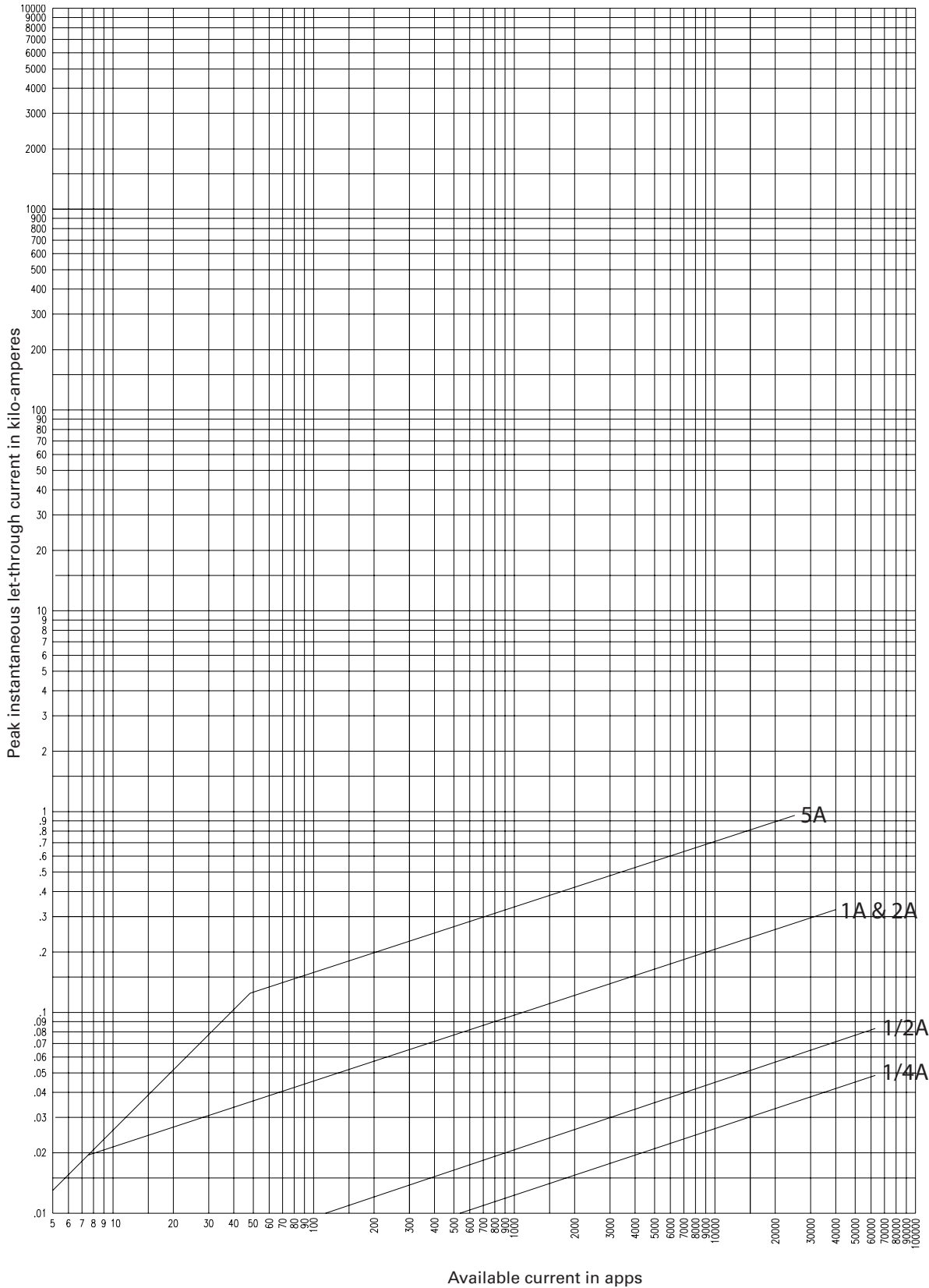

2NCLPT-E

CURVE 63933702
April 1999
Reference # 639337,
639338

3.6kV maximum system voltage

Amp rating	Dimensions - in (mm)			Catalog No. (Interrupting rating - kA)			Recommended fuseclip
	Length A	Diameter B	Clip centers C	Indicating	Non-indicating		
2	8.7 (221)	1.6 (41)	7.6 (193)	—	3.6CAV2 (50)		1A1837
3.15	5.6 (142)	1 (25)	4.4 (112)	—	3.6ABWNA3.15 (50)		
3.15	7.7 (195)	1 (25)	6.5 (165)	—	3.6ABCNA3.15 (50)		
6.3	5.6 (142)	1 (25)	4.4 (112)	—	3.6ABWNA6.3 (50)		A3354705
6.3	7.7 (195)	1 (25)	6.5 (165)	—	3.6ABCNA6.3 (50)		
10	7.7 (195)	1 (25)	6.5 (165)	—	3.6ABCNA10 (50)		

Dimensions (see catalog number tables for values)

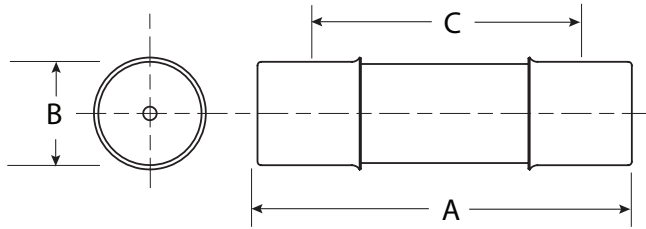

Recommended fuseclips:

Description	Cat. No.
Open fuseclip for 1.0 (25.4mm) dia. fuses	A3354705
Open fuseclip for 1.56 (39.7mm) / 1.6 (40.6mm) dia. fuses	1A0835

3.6kV Time-current curves — minimum melting for 3.6CAV_, 3.6ABC_ and 3.6ABW_

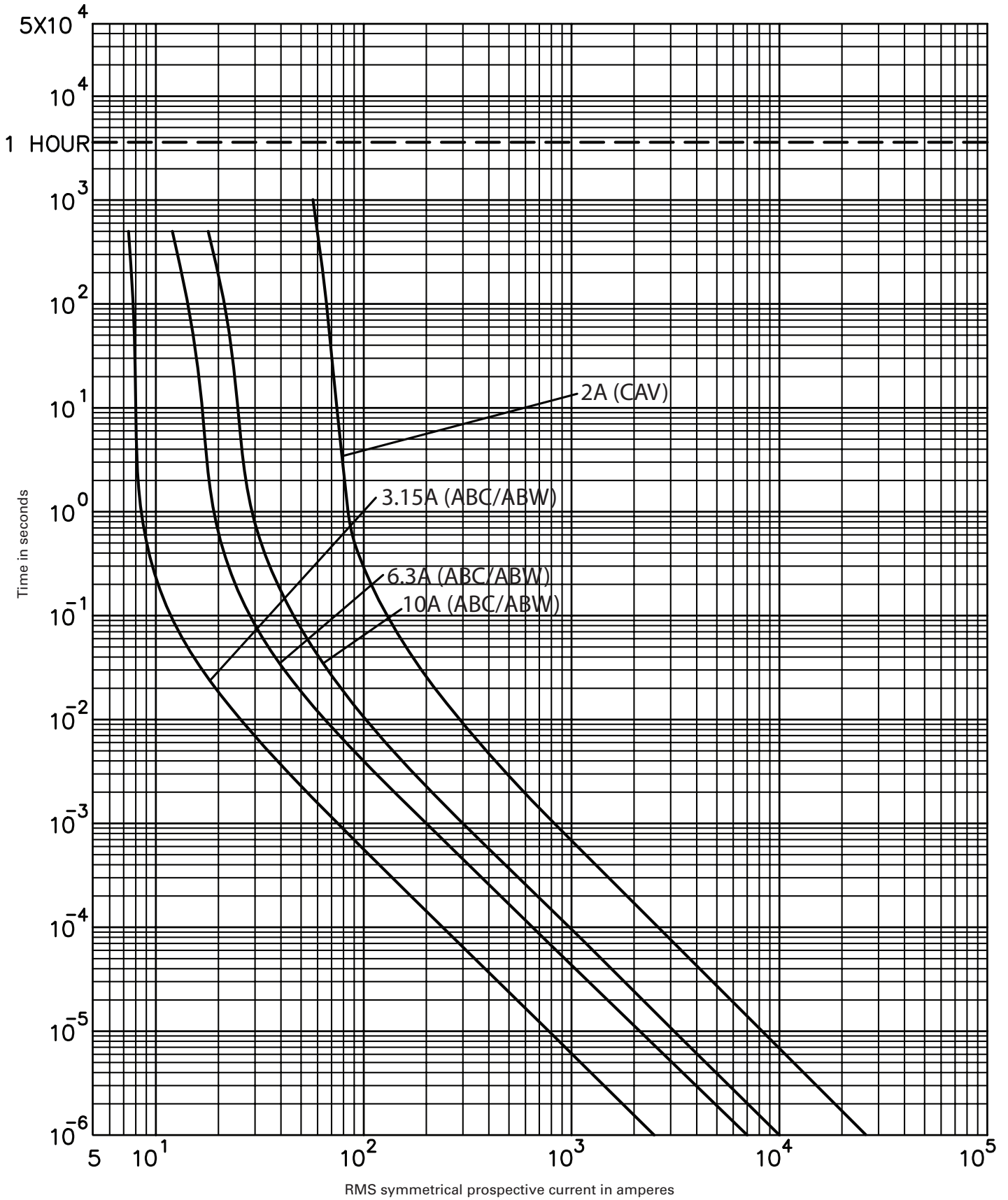

3.6ABC_, 3.6ABW_, 3.6CAV_

3.6kV Peak let-through curves for 3.6ABC_ and 3.6ABW_

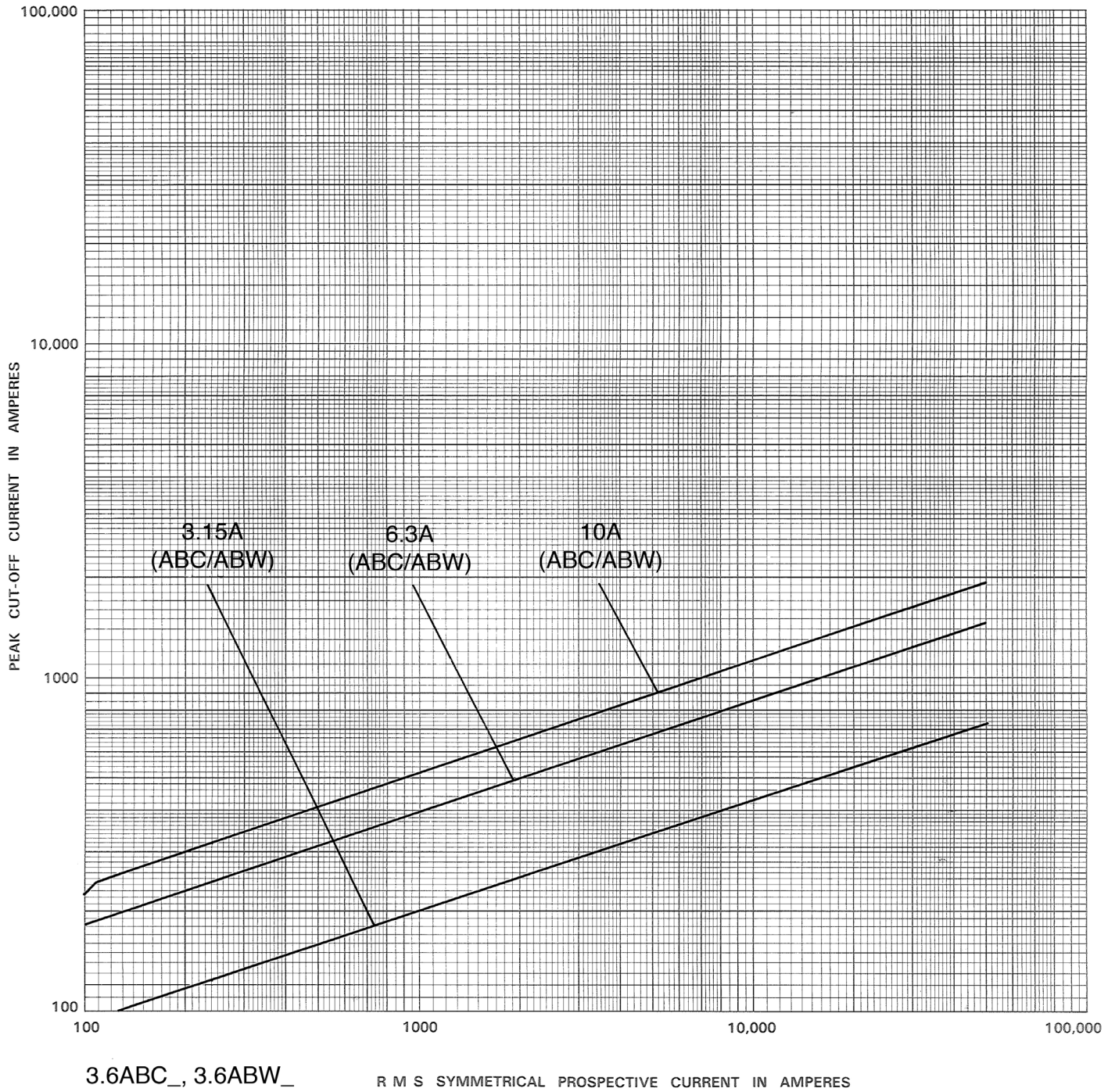

5.5kV maximum system voltage

Amp rating	Dimensions - in (mm)			Catalog No. (Interrupting rating - kA)		Recommended fuseclip
	Length A	Diameter B	Clip centers C	Indicating	Non-indicating	
0.5	5.6 (142)	0.8 (20)	4.8 (122)	—	5.5AMWNA0.5E (50)	1A1837
0.5	5.6 (142)	1 (25)	4.4 (112)	—	5.5ABWNA0.5E (50)	A3354705
0.5	7.4 (188)	1.6 (41)	6.2 (157)	5.5CAVH0.5E (63)	JCW-1/2E (40)	1A0835
0.5	9.5 (241)	1.6 (41)	8.1 (206)	5CLPT-.5E (80)†	5NCLPT-.5E-A (63)	1A0835
1	5.6 (142)	1 (25)	4.4 (112)	—	5.5ABWNA1E (50)	A3354705
1	5.6 (142)	0.8 (20)	4.8 (122)	—	5.5AMWNA1.0E (50)	1A1837
1	7.4 (188)	1.6 (41)	6.2 (157)	5.5CAVH1E (63)	JCW-1E (40)	1A0835
1	9.5 (241)	1.6 (41)	8.1 (206)	5CLPT-1E (80)†	5NCLPT-1E-A (63)	1A0835
1.5	9.5 (241)	1.6 (41)	8.1 (206)	5CLPT-1.5E (80)†	—	1A0835
2	5.6 (142)	1 (25)	4.4 (112)	—	5.5ABWNA2E (50)	A3354705
2	5.6 (142)	0.8 (20)	4.8 (122)	—	5.5AMWNA2.0E (50)	1A1837
2	7.4 (188)	1.6 (41)	6.2 (157)	5.5CAVH2E (63)	JCW-2E (40)	1A0835
3	5.6 (142)	1 (25)	4.4 (112)	—	5.5ABWNA3E (50)	A3354705
3	5.6 (142)	0.8 (20)	4.8 (122)	—	5.5AMWNA3.0E (50)	1A1837
3	9.5 (241)	1.6 (41)	8.1 (206)	5CLPT-3E (80)	—	1A0835
3	7.4 (188)	1.6 (41)	6.2 (157)	—	JCW-3E (40)	1A0835
4	5.6 (142)	0.8 (20)	4.8 (122)	—	5.5AMWNA4.0E (50)	1A1837
4	7.3 (185)	1.6 (41)	5.9 (150)	—	JCW-4E (40)	1A0835
5	9.5 (241)	1.6 (41)	8.1 (206)	5CLPT-5E (80)	—	1A0835
5	5.6 (142)	1 (25)	4.4 (112)	—	5.5ABWNA5E (50)	A3354705
5	5.6 (142)	0.8 (20)	4.8 (122)	—	5.5AMWNA5.0E (50)	1A1837
5	7.3 (185)	1.6 (41)	5.9 (150)	—	JCW-5E (40)	1A0835
10	9.5 (241)	1.6 (41)	8.1 (206)	5CLPT-10E (80)	—	1A0835
15	7.4 (188)	1.6 (41)	6.2 (157)	—	5.5CAV15E (63)	1A0835

† Does not comply with ANSI C37.46 for "E" rating.

CLPT Type mountings and hardware 5.5kV maximum (4.8kV nominal)*

Amp rating	Fuse mounting type**	BIL (kV)	Catalog number			
			Mounting (including live parts, end fittings)***		Live parts (including end fittings)***	End fittings (disconnect only)
CLPT and NCLPT-A Mounting						
0.5-10	Non-disconnect	60	5CLPT-PNM-A	5CLPT-GNM-A	CLPT-NL	—
	Disconnect†	60	5CLPT-PDM-A	5CLPT-GDM-A	CLPT-DL	CLPT-DF

* Refers to 5CLPT and 5NCLPT-A fuses only.

** See page 70 for dimensions and diagrams of typical mounting.

*** End fittings supplied only when required.

† Disconnect mountings provide a means for fuse extraction only. Do not use a disconnect mounting for load switching or fuse removal while energized.

Dimensions (see catalog number tables for values)

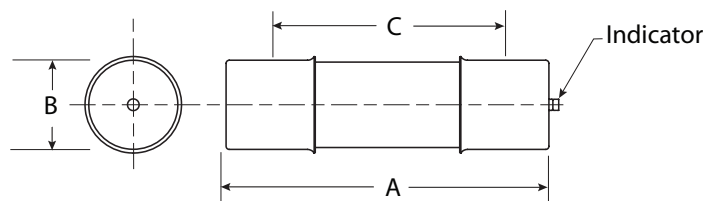

Recommended fuseclips:

Description	Cat. No.
Open fuseclip for 0.8 (20mm) dia. fuses	1A1837
Open fuseclip for 1.0 (25.4mm) dia. fuses	A3354705
Open fuseclip for 1.56 (39.7mm) / 1.6 (40.6mm) dia. fuses	1A0835

5.5kV time-current curves — minimum melting for 5NCLPT_-A

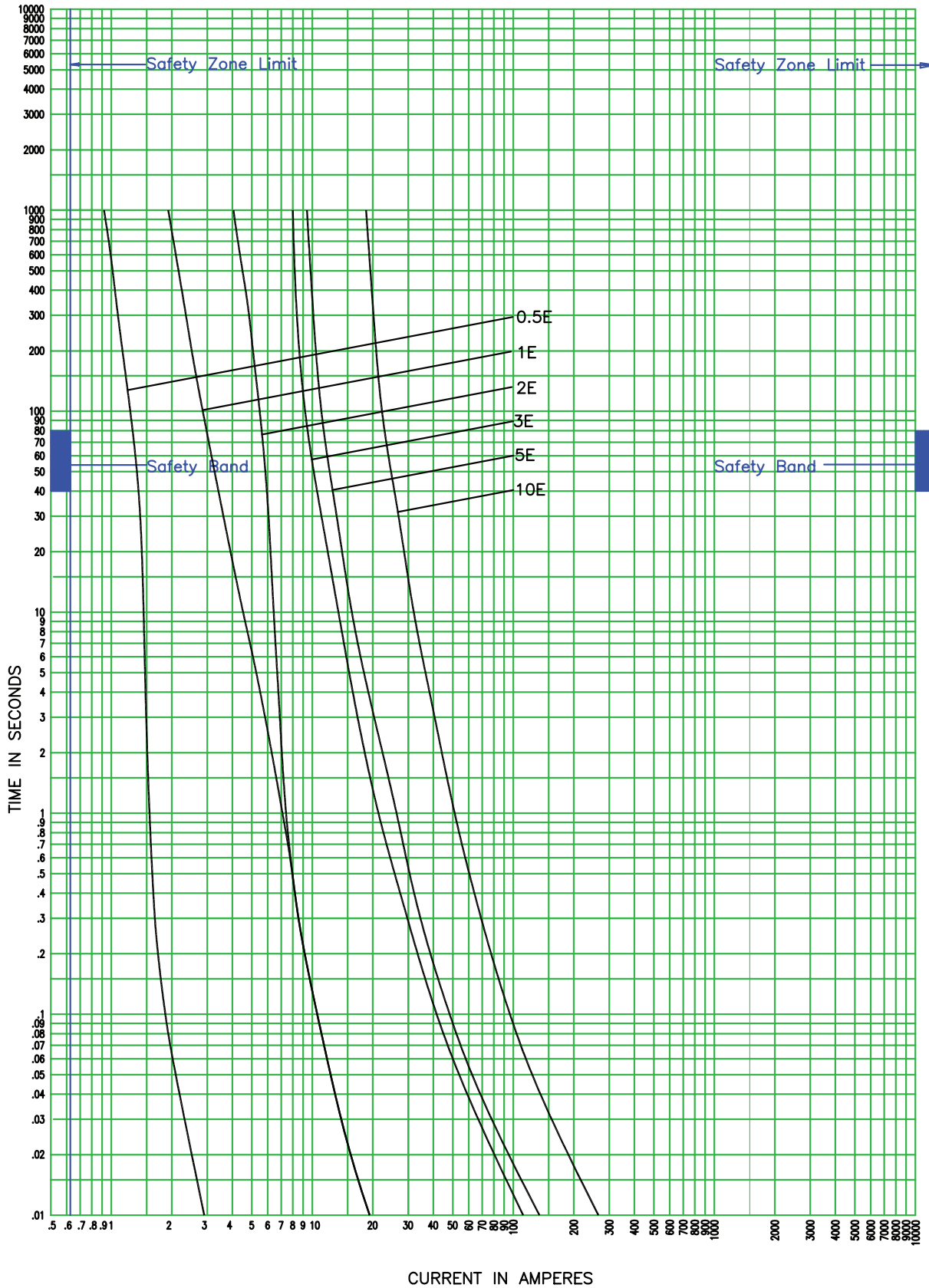

5NCLPT_E-A

CURVE TC70548302
December 2008

5.5kV time-current curves — total clearing for 5NCLPT_-A

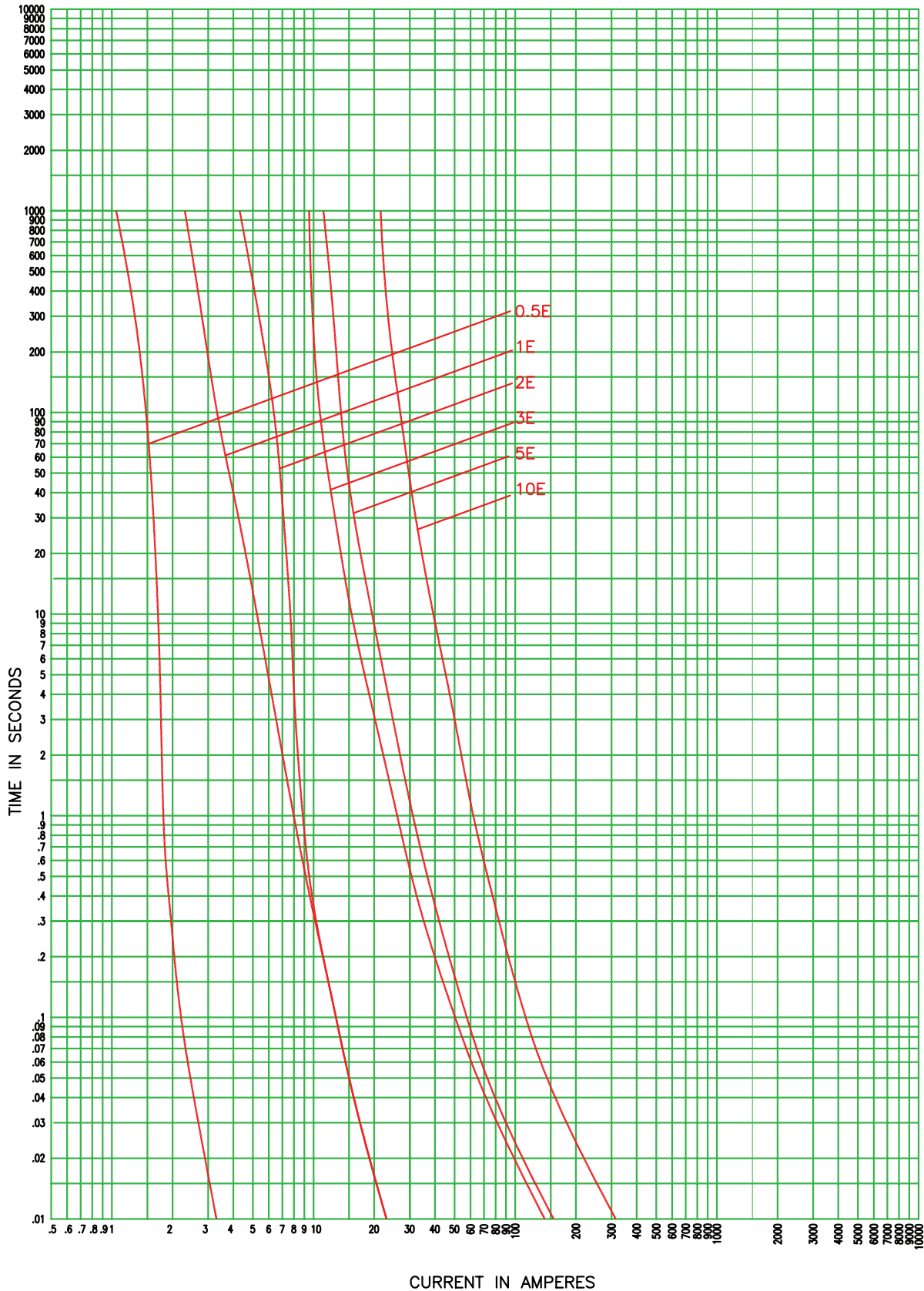

5NCLPT_E-A

CURVE TC70548402
December 2008

5.5kV peak let-through curves for 5NCLPT_-A

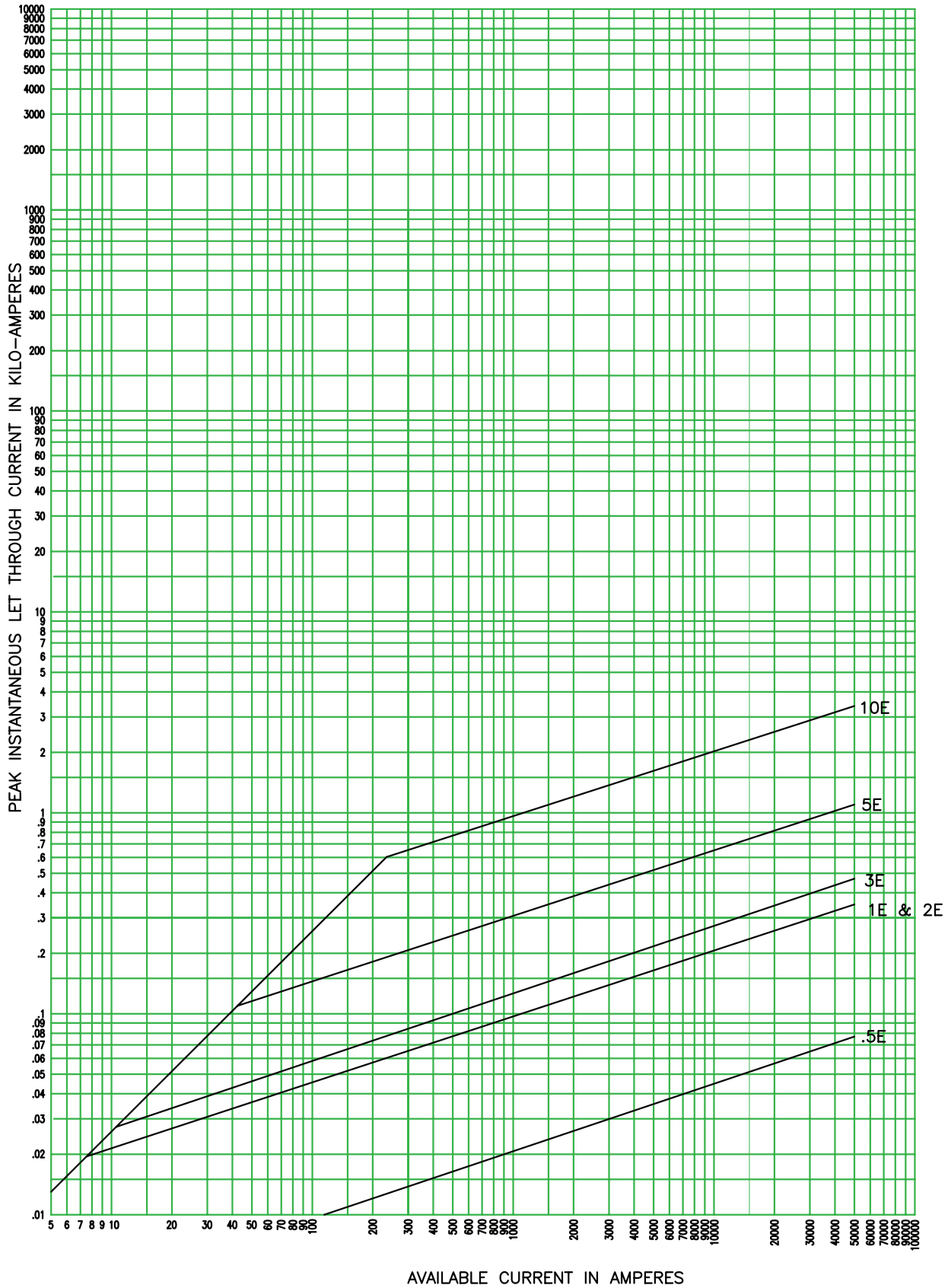

CURVE TC63934002
 December 2008

5NCLPT- F-A

5.5kV time-current curves — minimum melting for 5NCLPT_

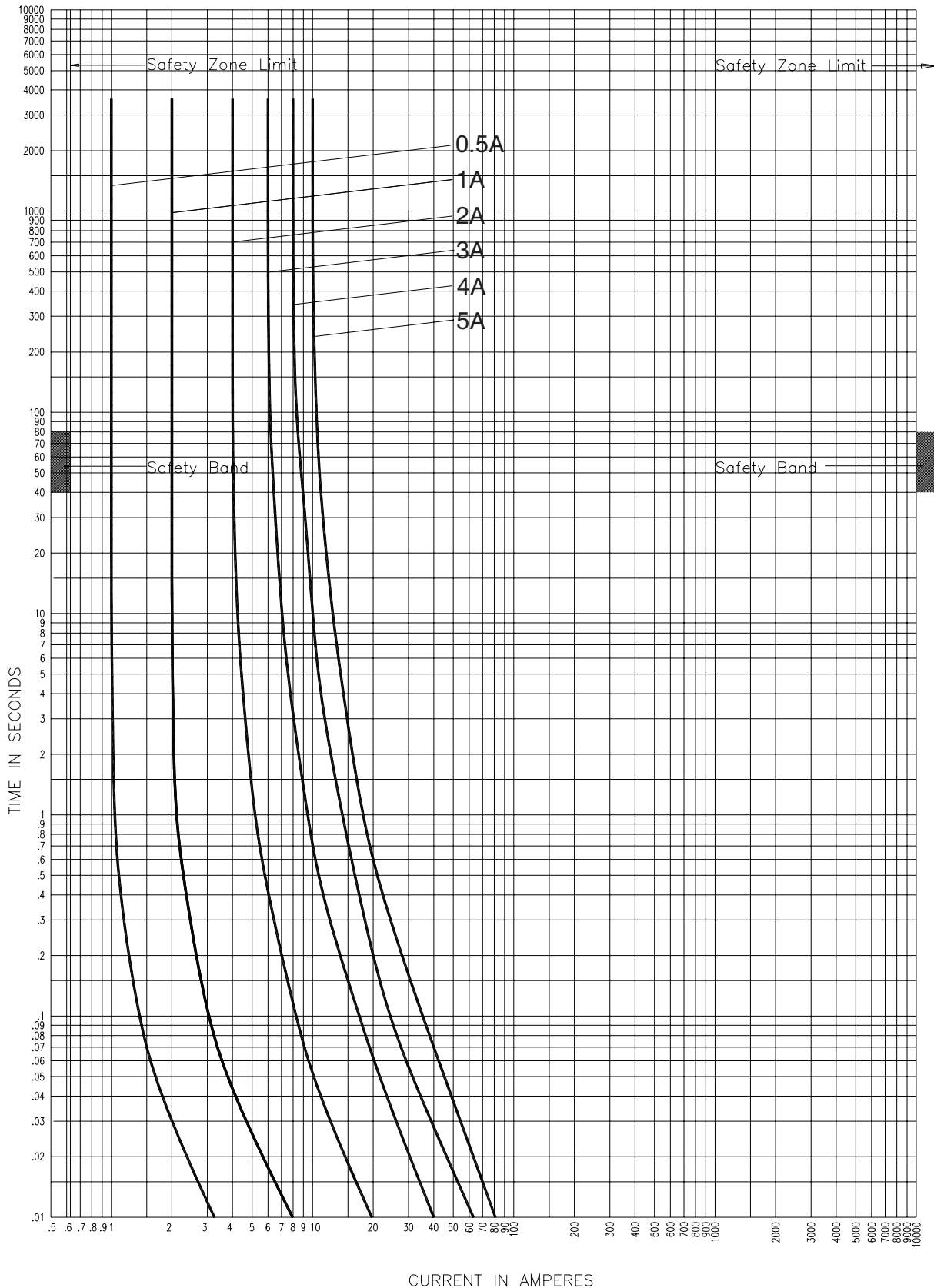

5NCLPT-E

CURVE 66702402
July 2002
Reference # 667024

5.5kV time-current curves — total clearing for 5NCLPT_

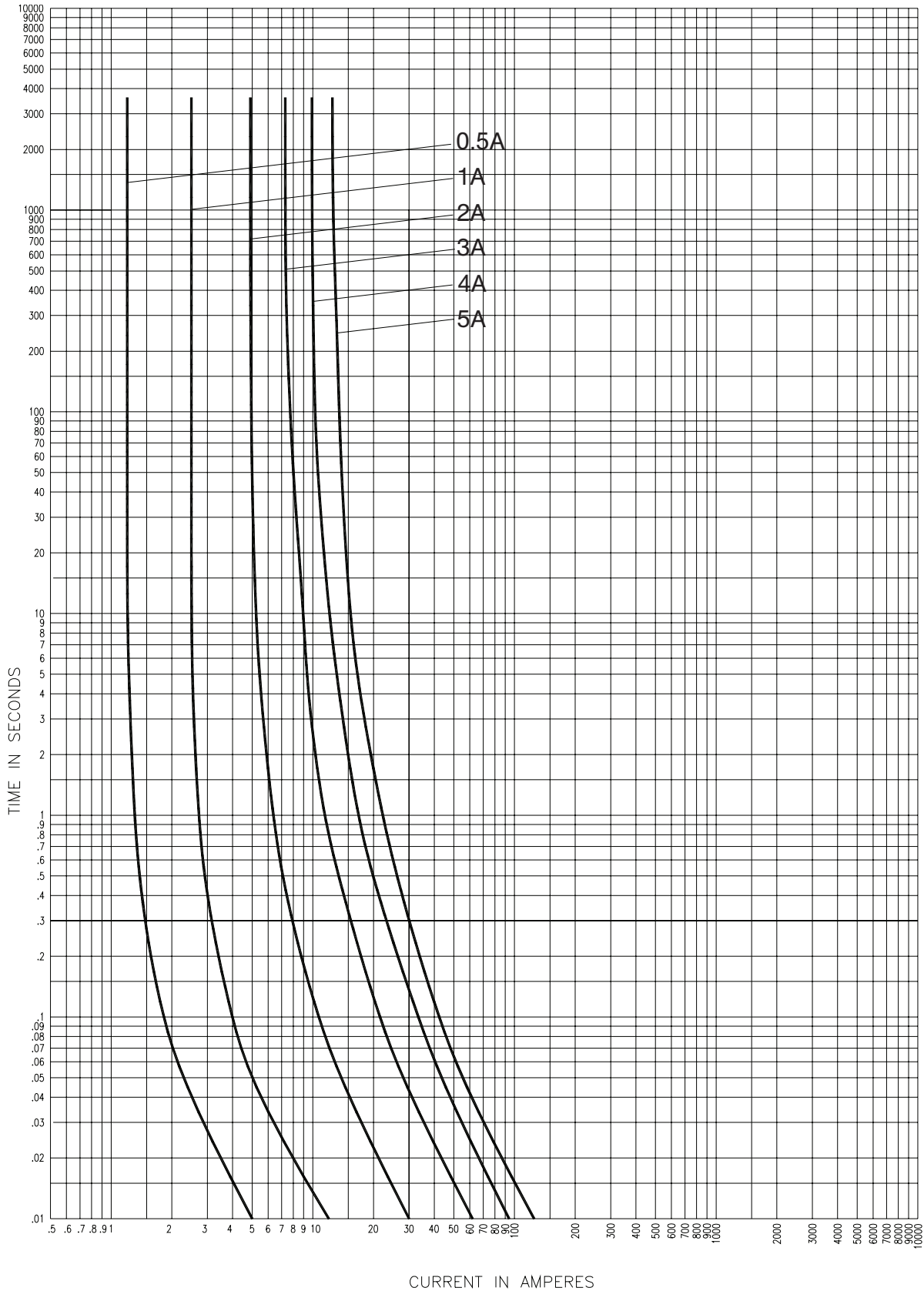

5NCLPT-E

CURVE 66702502
July 2002
Reference # 667025

5.5kV peak let-through curves for 5NCLPT_

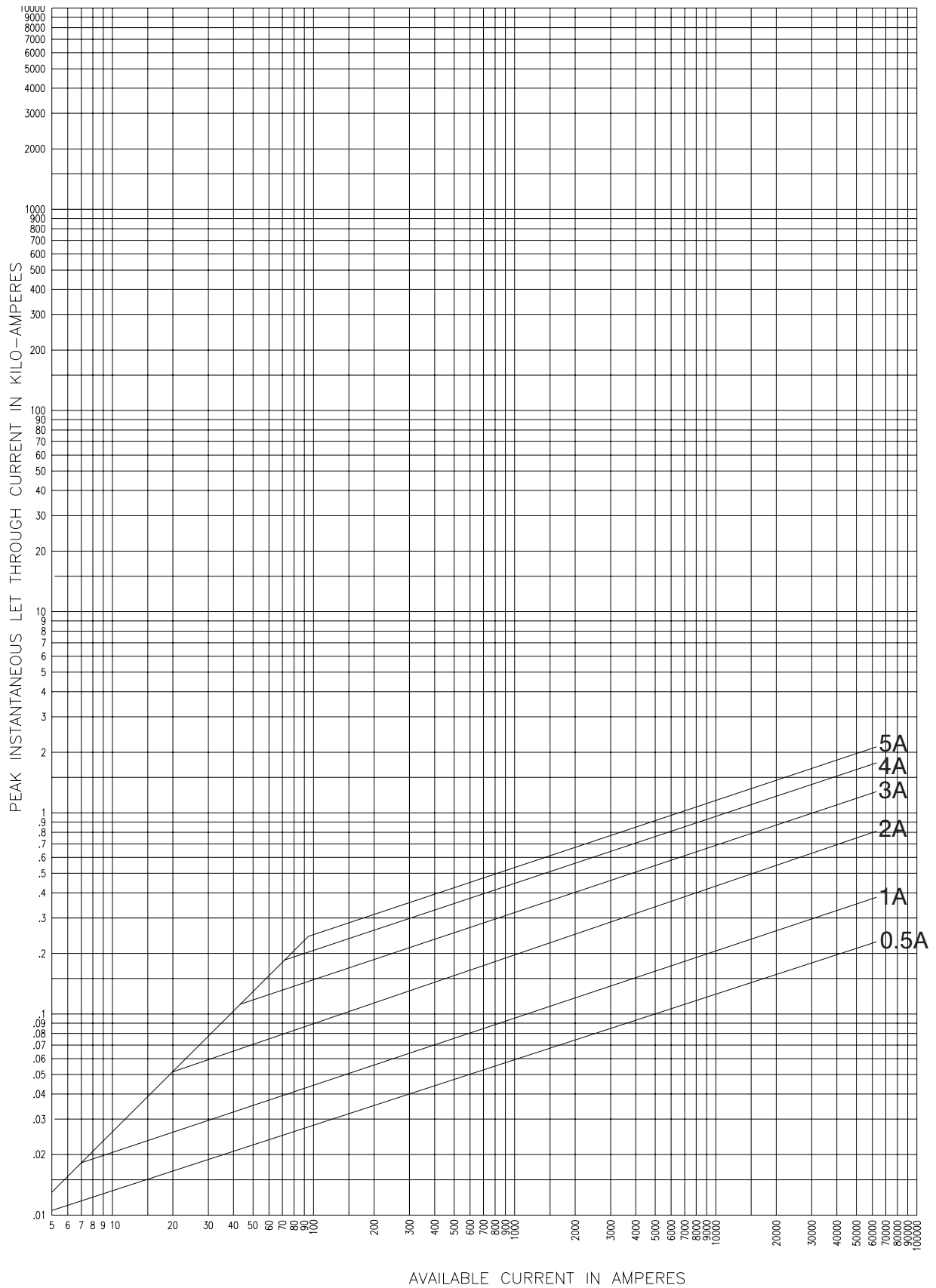

5NCLPT_E

CURVE 66704101
July 2001

5.5kV time-current curves — minimum melting for 5CLPT_

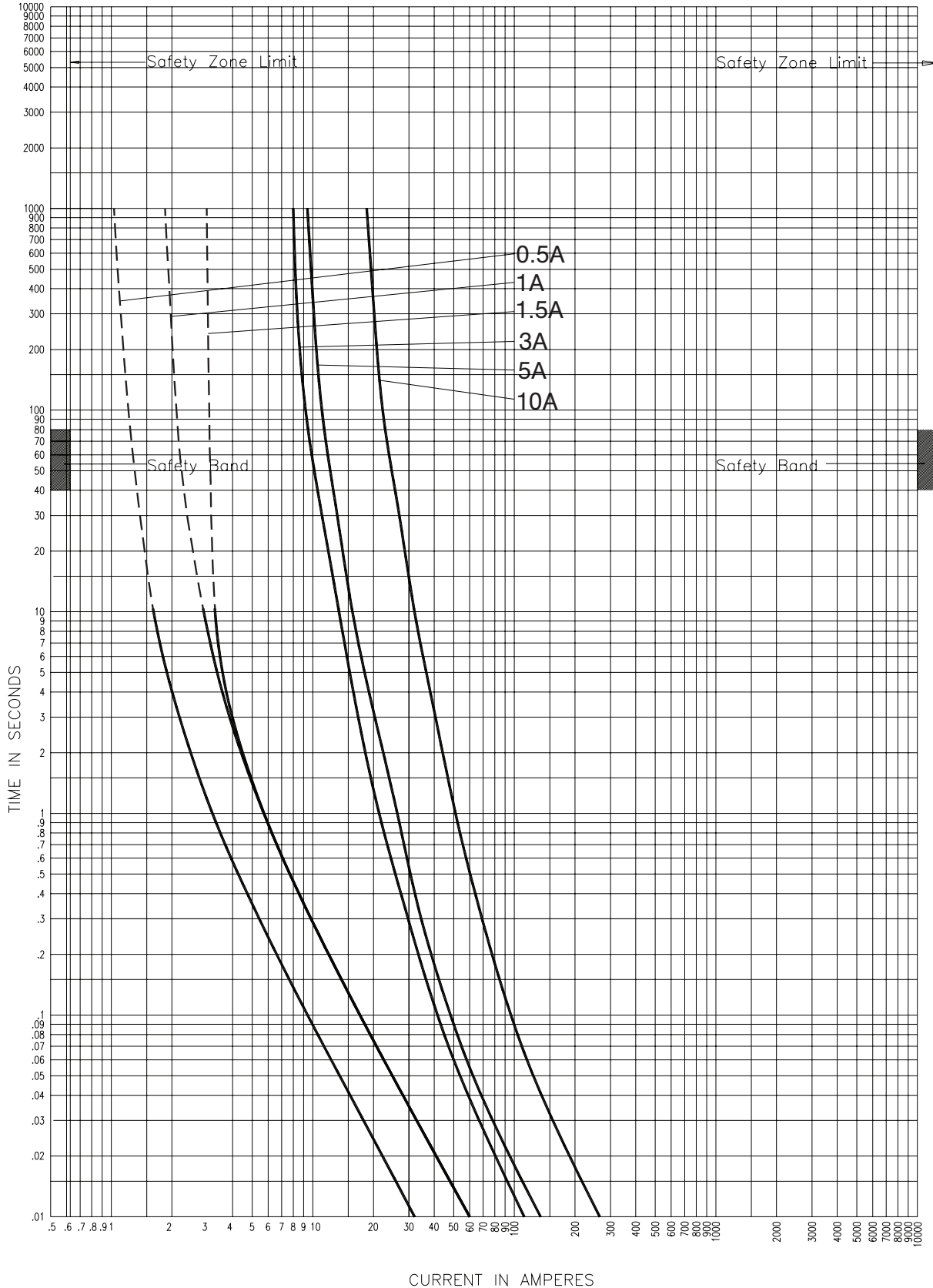

0.5, 1 and 1.5 A fuse melt times in the dotted line region may not be assured due to manufacturing variations. The dotted lines show nominal operation. Some individual fuses may not open until current at 10-second mark is applied.

CURVE 56353206
July 2002
Reference # 563532

5CLPT-_E

5.5kV Time-current curves — total clearing for 5CLPT_

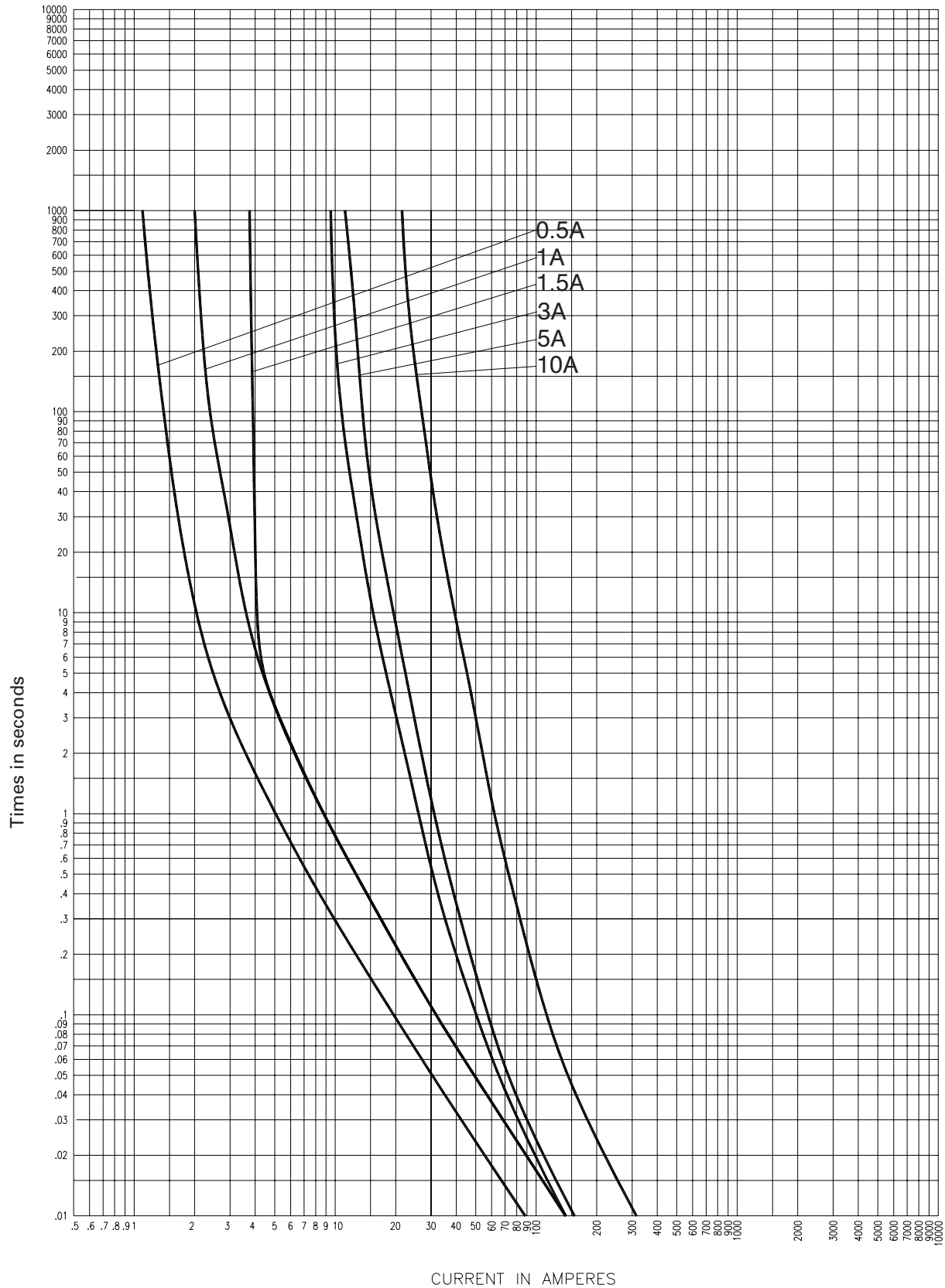

5CLPT-_E

CURVE 56353306
July 2002
Reference # 563533

5.5kV peak let-through curves for 5CLPT_

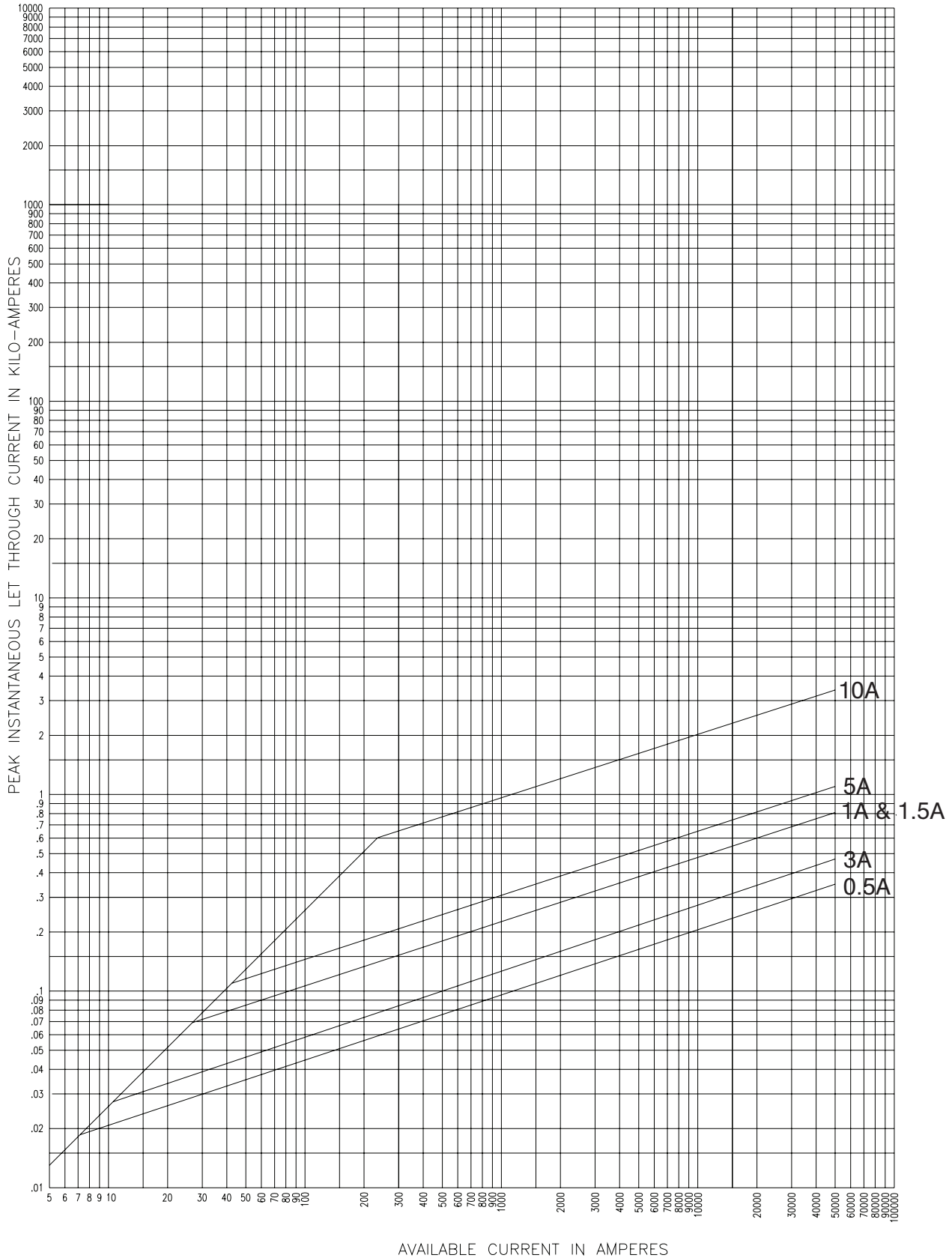

5CLPT_E

63934001
 July 2001
 Reference # 639340

5.5kV time-current curves — minimum melting for 5.5CAV_ and 5.5CAVH_

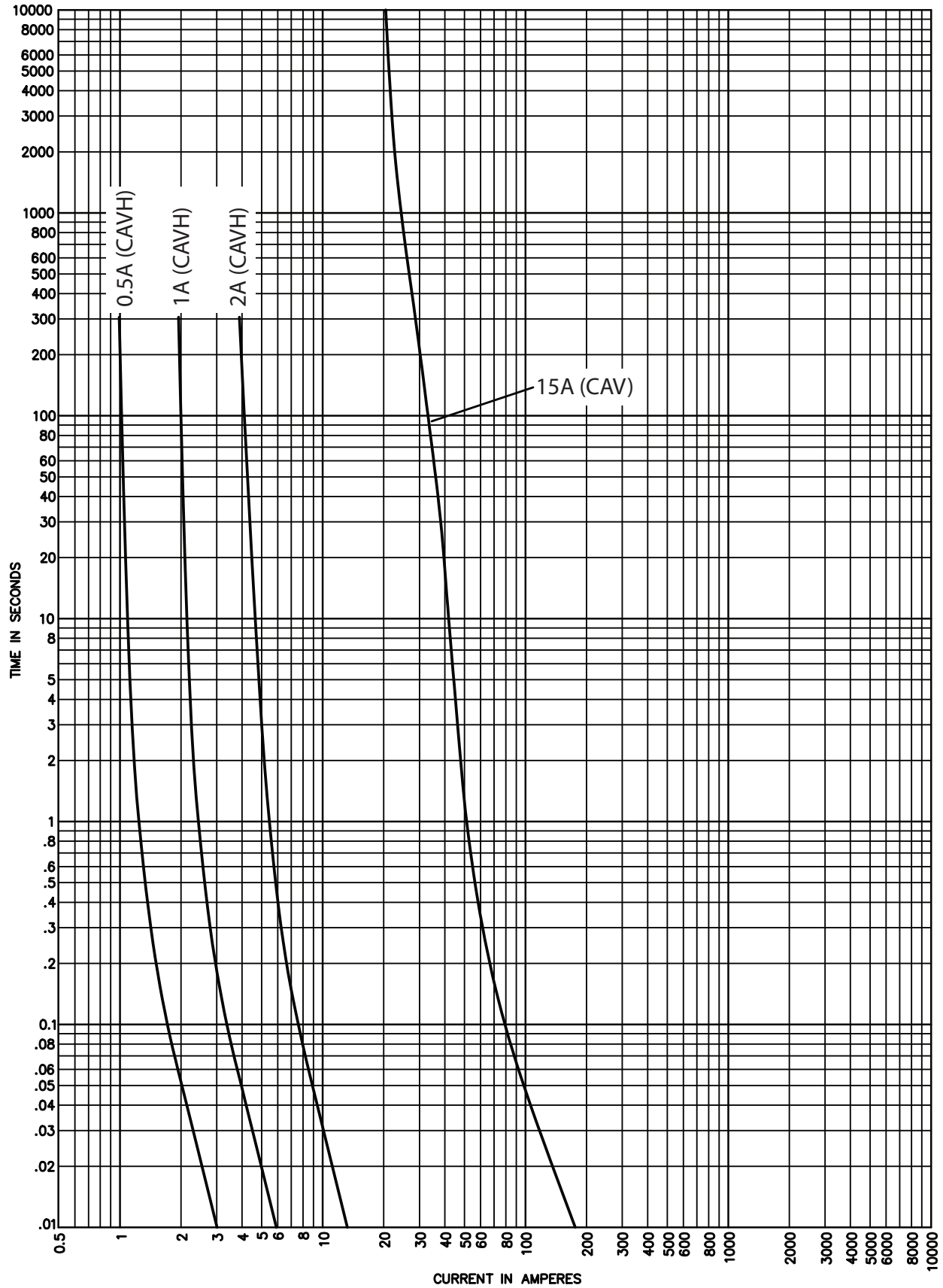

5.5CAV_, 5.5CAVH_

5.5kV time-current curves — total clearing for 5.5CAV_

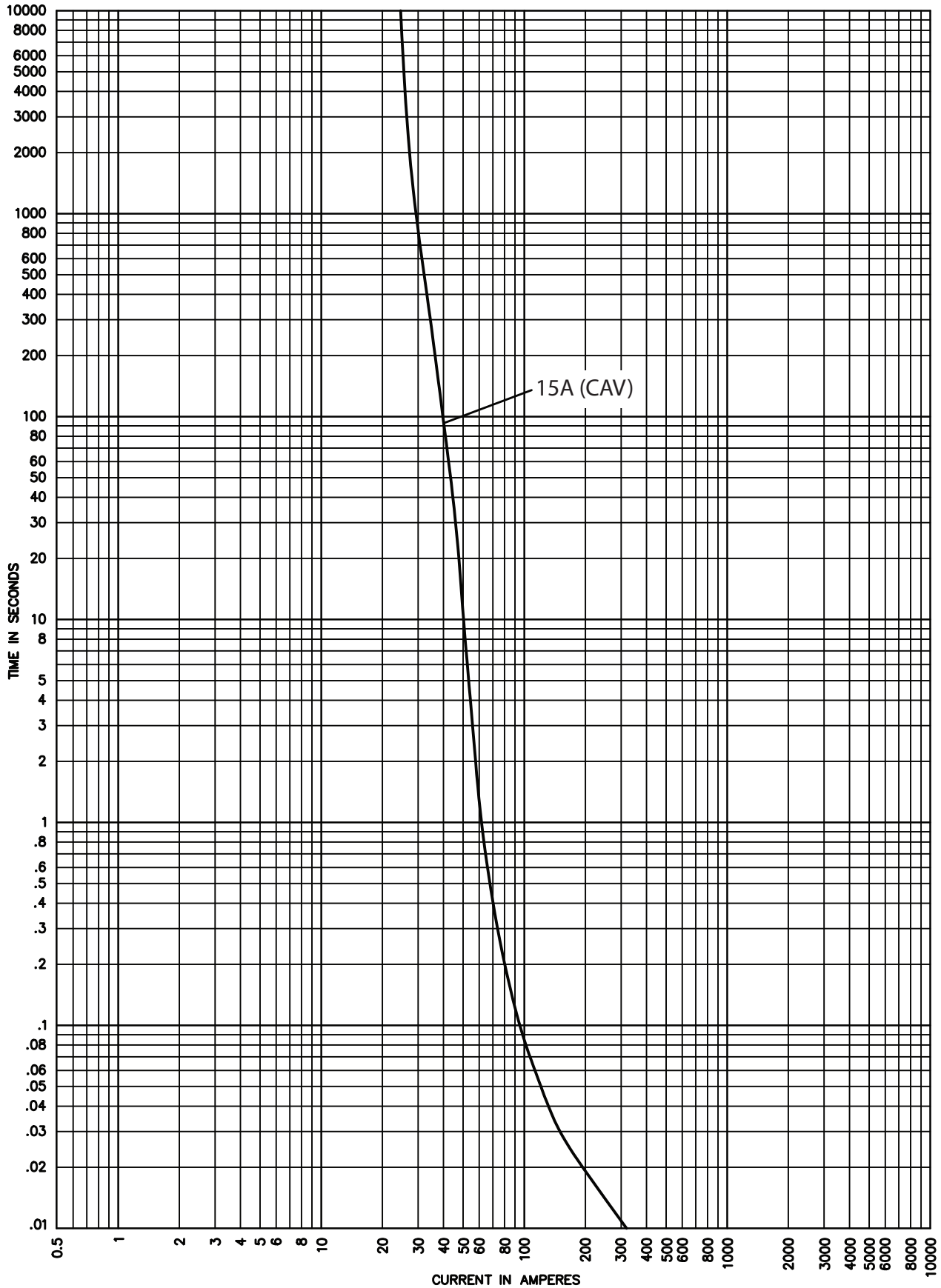

5.5CAV

5.5kV peak let-through curves for 5.5CAVH_

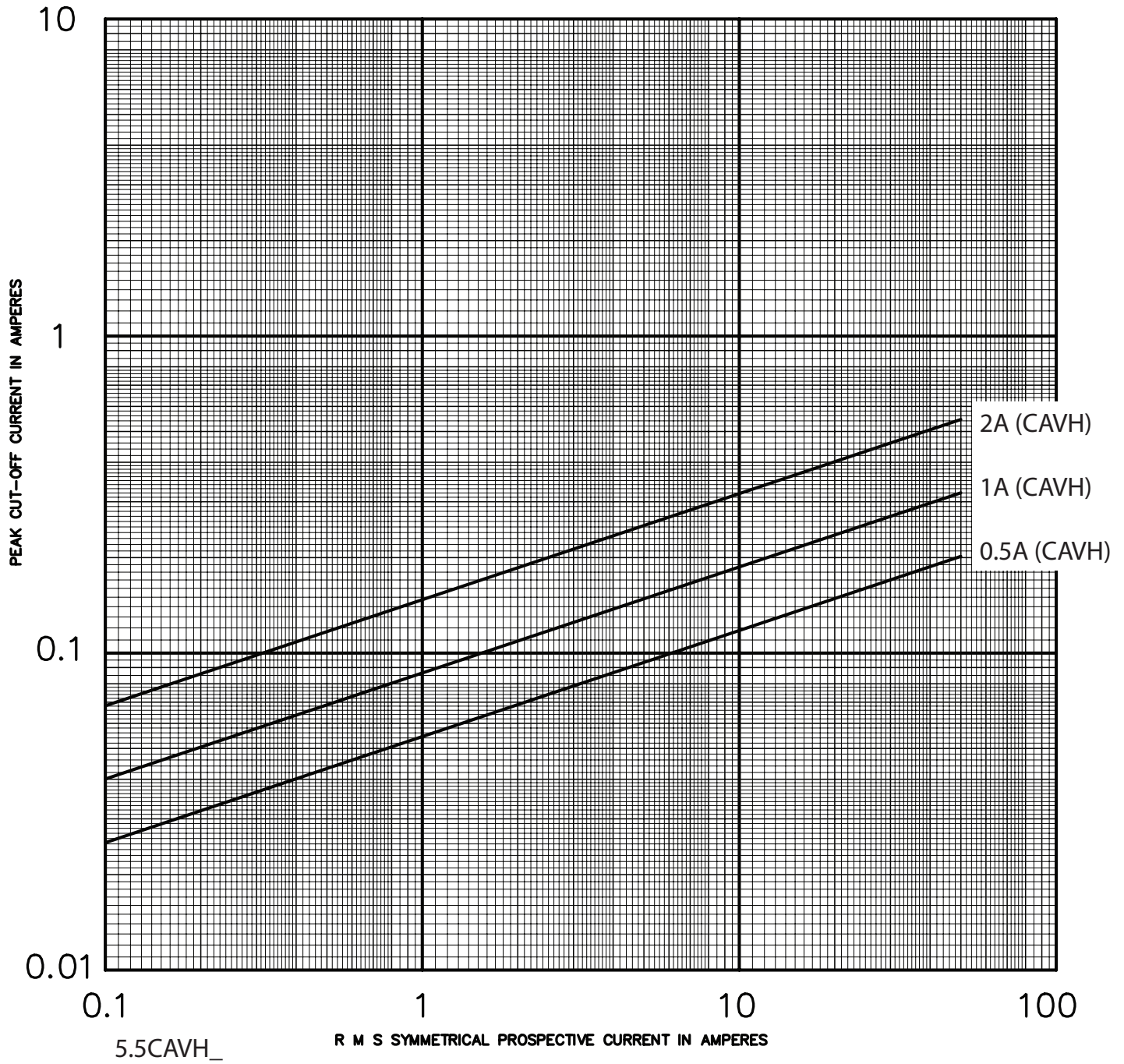

5.5kV time-current curves — minimum melting for 5.5ABW_ and 5.5AMW_

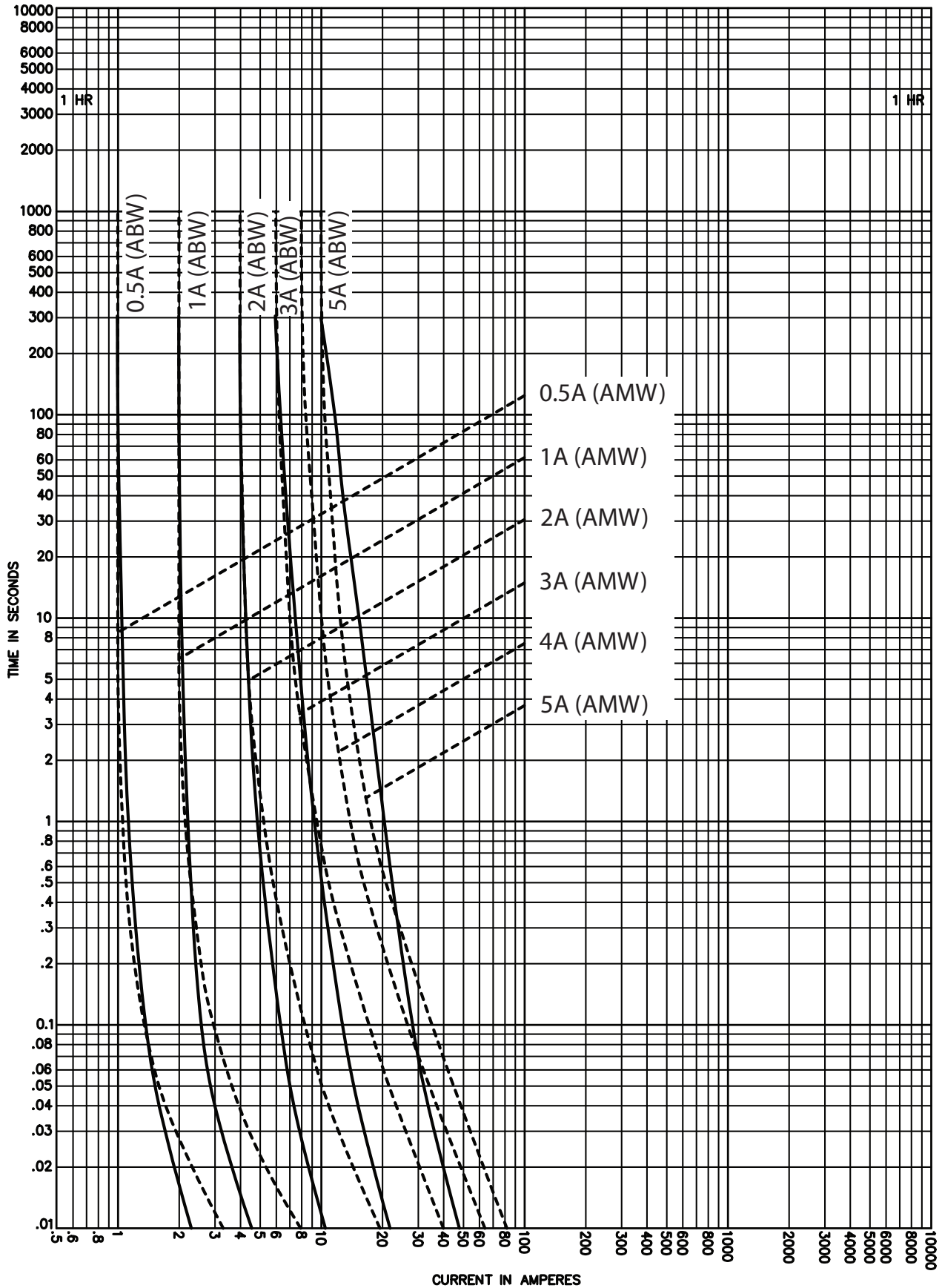

5.5ABW_ , 5.5AMW_

5.5kV time-current curves — total clearing for 5.5ABW_ and 5.5AMW_

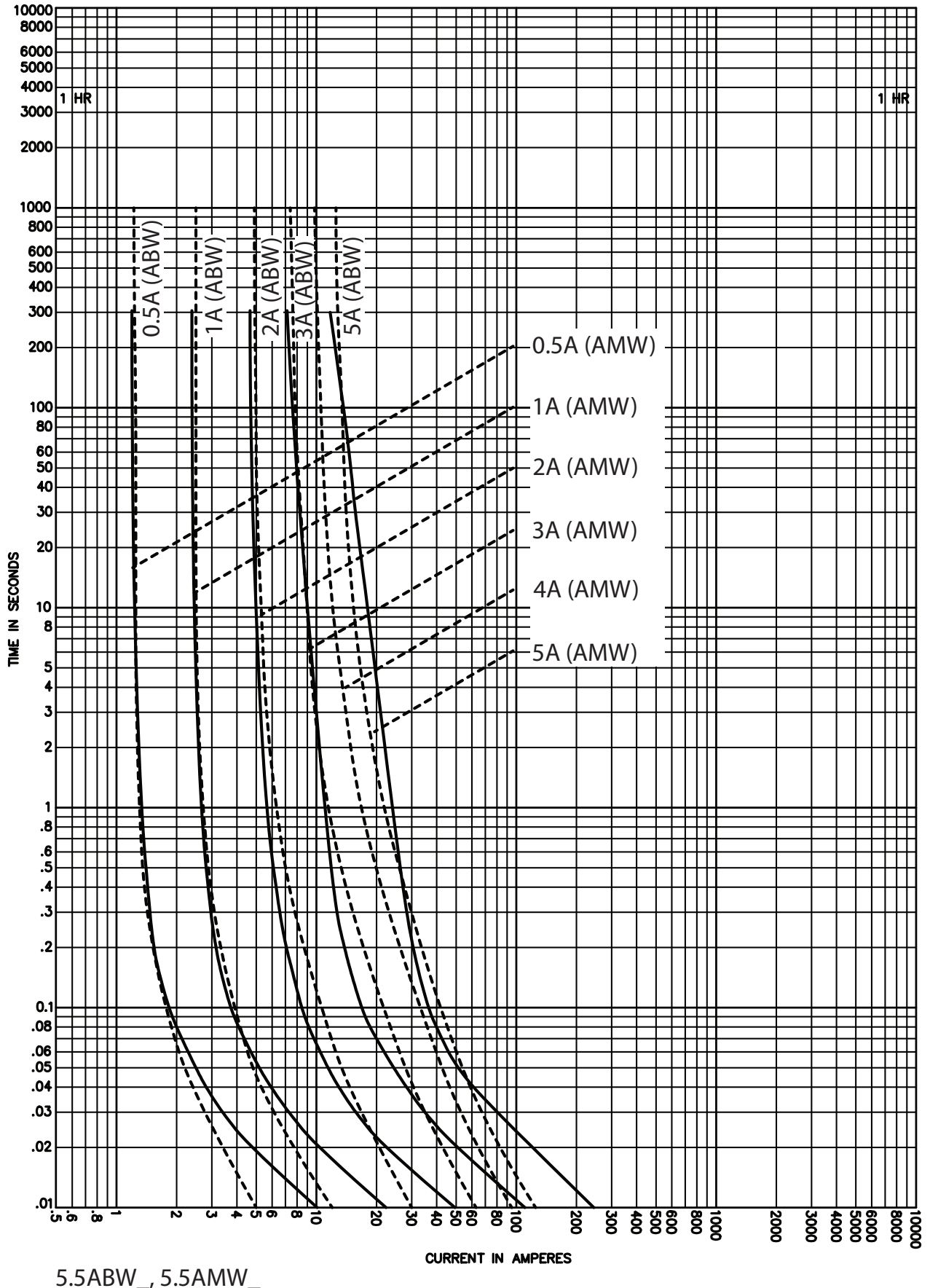

5.5ABW_ , 5.5AMW_

5.5kV peak let-through curves for 5.5ABW_ and 5.5AMW_

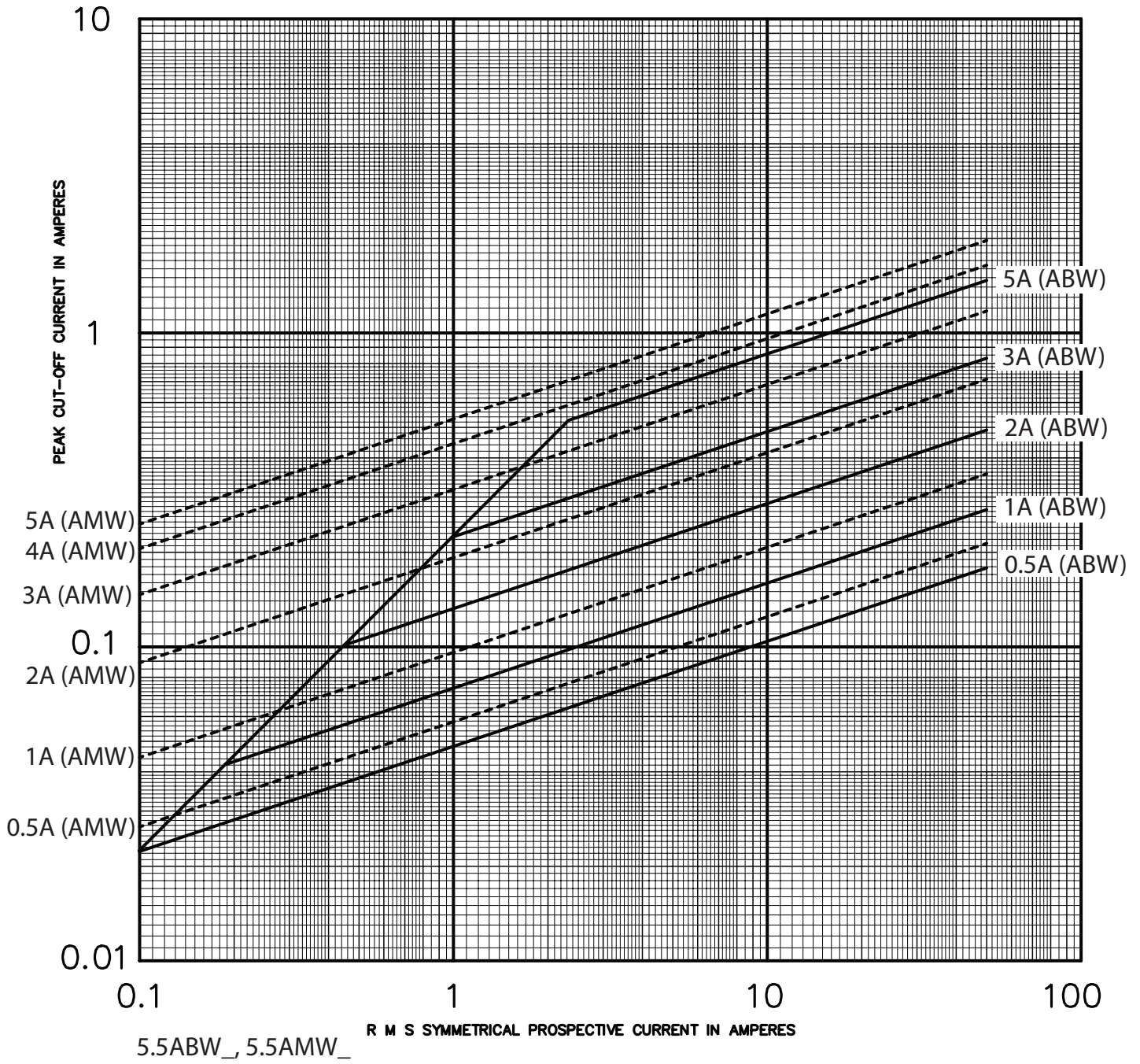

7.2kV maximum system voltage

Amp rating	Dimensions - in (mm)			Catalog No. (Interrupting rating - kA)		Recommended fuseclip
	Length A	Diameter B	Clip centers C	Indicating	Non-indicating	
0.5	5.6 (142)	0.8 (20)	4.8 (122)	—	7.2AMWNA0.5E (50)	
1	5.6 (142)	0.8 (20)	4.8 (122)	—	7.2AMWNA1.0E (50)	1A1837
2	5.6 (142)	0.8 (20)	4.8 (122)	—	7.2AMWNA2.0E (50)	
2	8.7 (221)	1.6 (41)	7.5 (190)	—	7.2CAV2 (63)	1A0835
3	5.6 (142)	0.8 (20)	4.8 (122)	—	7.2AMWNA3.0E (50)	1A1837
3.15	5.6 (142)	1 (25.4)	4.4 (112)	—	7.2ABWNA3.15 (45)	
3.15	7.7 (195)	1 (25.4)	6.5 (165)	—	7.2ABCNA3.15 (45)	A3354705
4	5.6 (142)	0.8 (20)	4.8 (122)	—	7.2AMWNA4.0E (50)	1A1837
4	8.7 (221)	1.6 (41)	7.5 (190)	—	7.2CAV4 (63)	1A0835
5	5.6 (142)	0.8 (20)	4.8 (122)	—	7.2AMWNA5E (50)	1A1837
6	8.7 (221)	1.6 (41)	7.5 (190)	—	7.2CAV6 (63)	1A0835
6.3	5.6 (142)	1 (25.4)	4.4 (112)	—	7.2ABWNA6.3 (45)	
6.3	7.7 (195)	1 (25.4)	6.5 (165)	—	7.2ABCNA6.3 (45)	A3354705
10	8.7 (221)	1.6 (41)	7.5 (190)	—	7.2CAV10 (63)	1A0835

Dimensions (see catalog number tables for values)

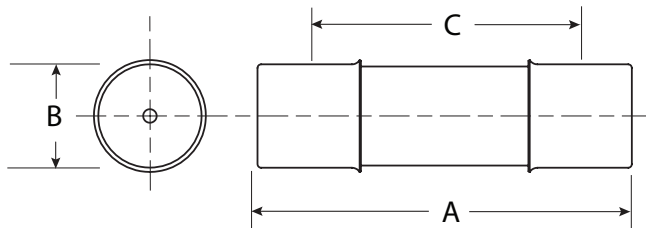

Recommended fuseclips

Description	Cat. No.
Open fuseclip for 0.8 (20mm) dia. fuses	1A1837
Open fuseclip for 1.0 (25.4mm) dia. fuses	A3354705
Open fuseclip for 1.56 (39.7mm) / 1.6 (40.6mm) dia. fuses	1A0835

7.2kV time-current curves — minimum melting for 7.2ABW_ and 7.2CAV_

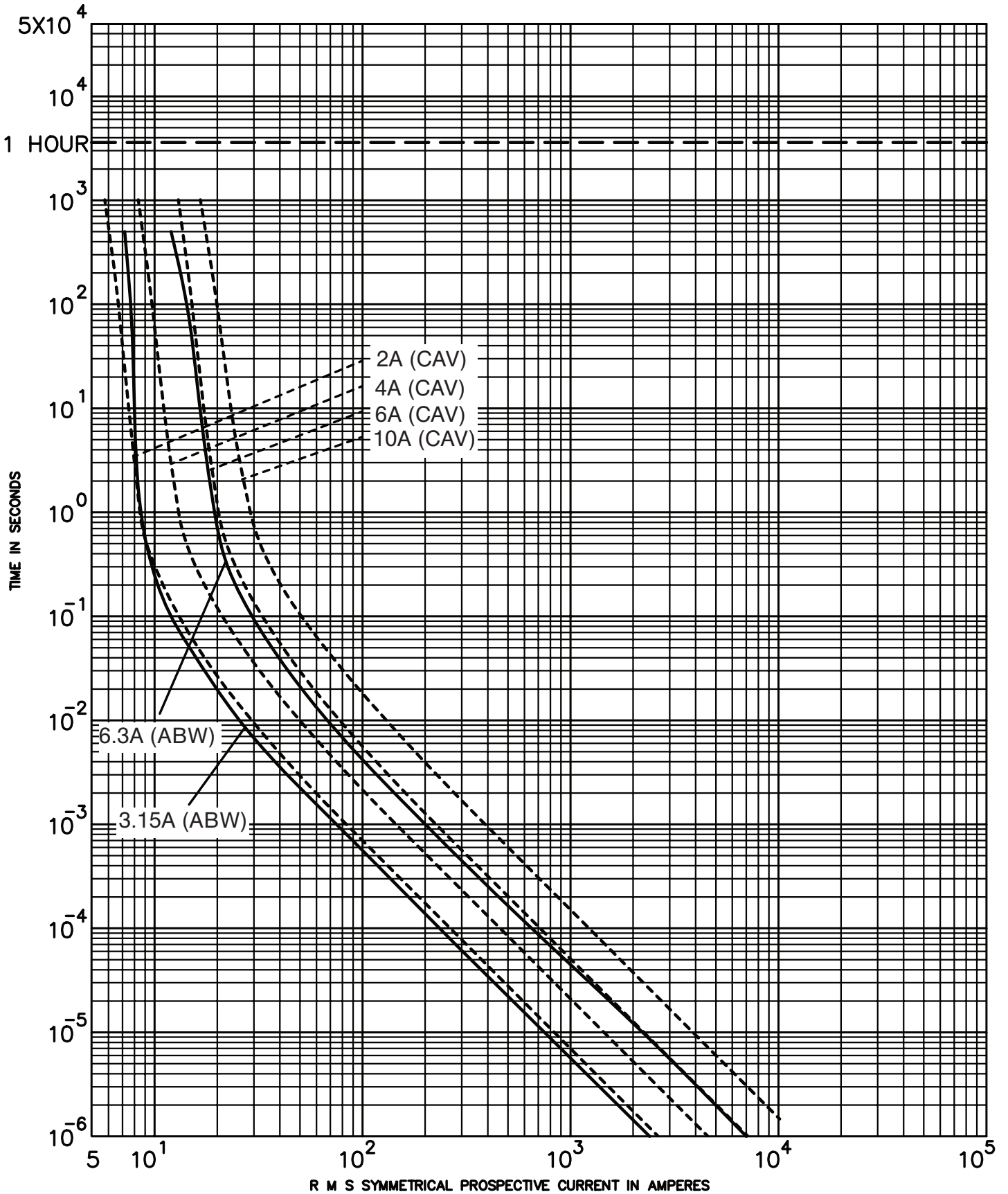

7.2ABW_ , 7.2CAV_

7.2kV peak let-through curves for 7.2ABW_

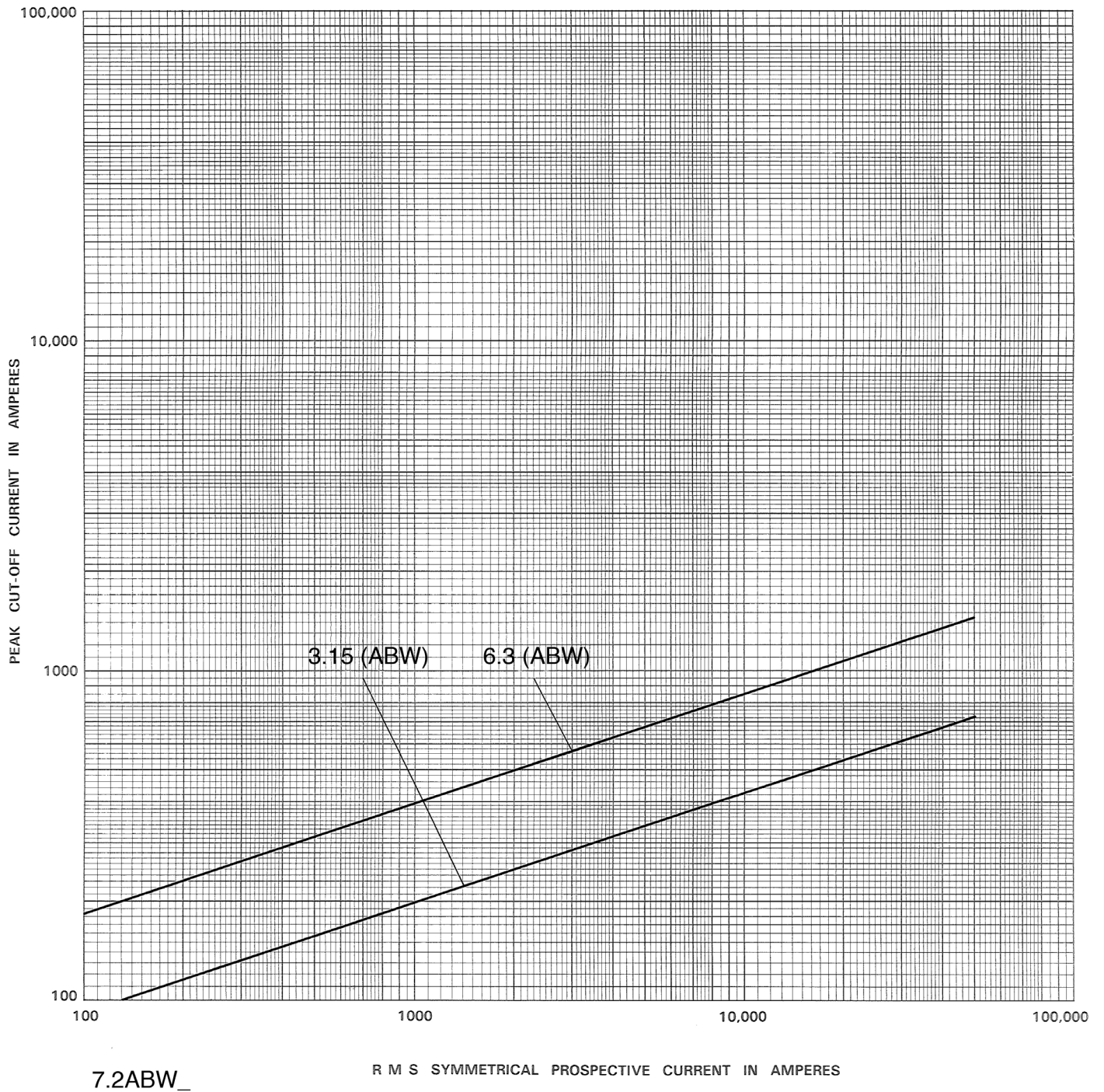

7.2ABW_

R M S SYMMETRICAL PROSPECTIVE CURRENT IN AMPERES

8.3kV maximum system voltage

Amp rating	Dimensions - in (mm)			Catalog No. (interrupting rating - kA)		Recommended fuseclip
	Length A	Diameter B	Clip centers C	Indicating	Non-indicating	
0.5	9.5 (241)	1.6 (41)	8.1 (206)	8CLPT-5E-A (80) [†]	8NCLPT-5E-A (50)	1A0835
1	5 (127)	1.1 (28)	4 (102)	—	8NCLPT-1E (50)	A3354705
1	9.5 (241)	1.6 (41)	8.1 (206)	—	8NCLPT-1E-A (50)	1A0835
2	8 (203)	0.8 (20)	7.2 (183)	—	8NCLPT-2E (25)	1A1837
2	9.5 (241)	1.6 (41)	8.1 (206)	—	8NCLPT-2E-A (50)	1A0835
3	12.9 (328)	1.6 (41)	11.5 (292)	8CLPT-3E-B (80)	8NCLPT-3E-B (50)	1A0835
4	8 (203)	0.8 (20)	7.2 (183)	—	8NCLPT-4E (25)	1A1837
5	5 (127)	1.1 (28)	4 (102)	—	8NCLPT-5E (50)	A3354705
5	12.9 (328)	1.6 (41)	11.5 (292)	8CLPT-5E-B (50)	8NCLPT-5E-B (50)	1A0835
10	12.9 (328)	1.6 (41)	11.5 (292)	8CLPT-10E-B (50)	8NCLPT-10E-B (50)	1A0835

† Does not comply with ANSI C37.46 for “E” rating.

CLPT type mountings and hardware 8.3kV maximum (7.2kV nominal)*

Amp rating	Fuse mounting type**	BIL (kV)	Catalog number			
			Mounting (including live parts, end fittings)***		Live parts (including end fittings)***	End fittings (disconnect only)
			Porcelain insulator	Glass-polyester insulator		
0.5–2	Non-disconnect	75	8CLPT-PNM-A	8CLPT-GNM-A	CLPT-NL	—
	Disconnect [†]	75	8CLPT-PDM-A	8CLPT-GDM-A	CLPT-DL	CLPT-DF
3–10	Non-disconnect	75	8CLPT-PNM-B	8CLPT-GNM-B	CLPT-NL	—
	Disconnect [†]	75	8CLPT-PDM-B	8CLPT-GDM-B	CLPT-DL	CLPT-DF

* Refers to 8CLPT and 8NCLPT-A or -B fuses only.

** See page 70 for dimensions and diagrams of typical mounting.

*** End fittings supplied only when required.

† Disconnect mountings provide a means for fuse extraction only. Do not use a disconnect mounting for load switching or fuse removal while energized.

Dimensions (see catalog number tables for values)

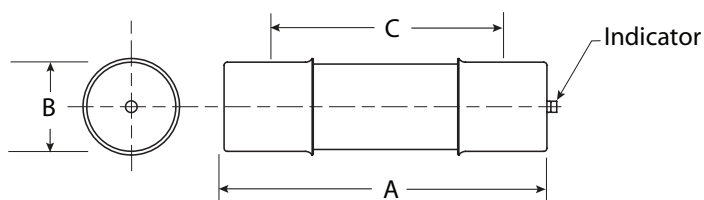

Recommended fuseclips:

Description	Cat. No.
Open fuseclip for 0.8 (20mm) dia. fuses	1A1837
Open fuseclip for 1.0 (25.4mm) dia. fuses	A3354705
Open fuseclip for 1.56 (39.7mm) / 1.6 (40.6mm) dia. fuses	1A0835

8.3kV time-current curves — minimum melting for 8NCLPT_

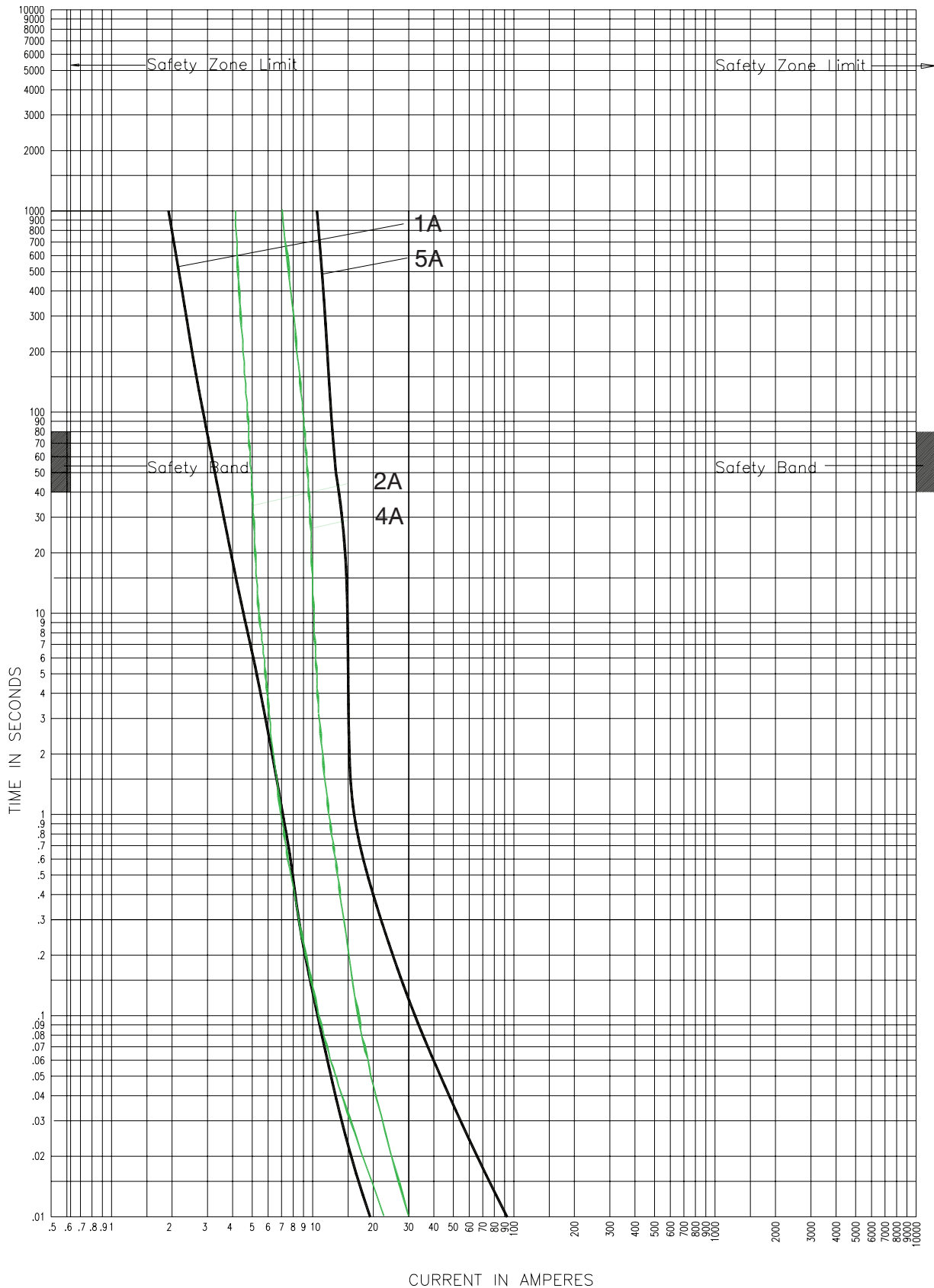

8NCLPT_E

Curve 59887102
July 2002
Reference # 628852, 598871

Curve 56357206
July 2002

8.3kV time-current curves — total clearing for 8NCLPT_

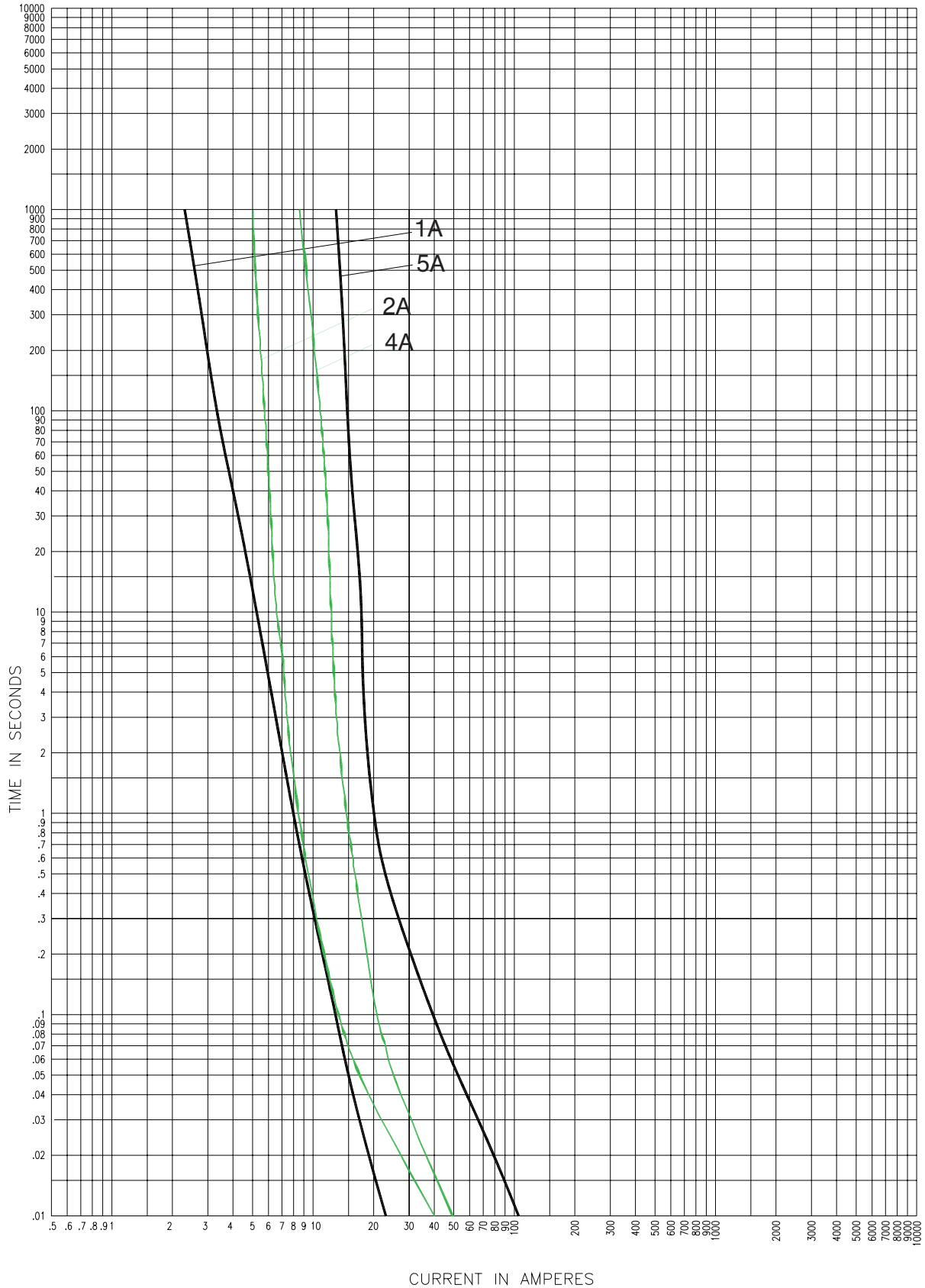

8NCLPT-_E

Curve 59887104
July 2002
Reference # 598871

Curve 59883706
July 2002

8.3kV peak let-through curves for 8NCLPT_



8NCLPT_E

Curve 63933703
July 2001
Reference # 639337

Curve 63933704
July 2001
Reference # 639337

8.3kV time-current curves — minimum melting for 8CLPT_

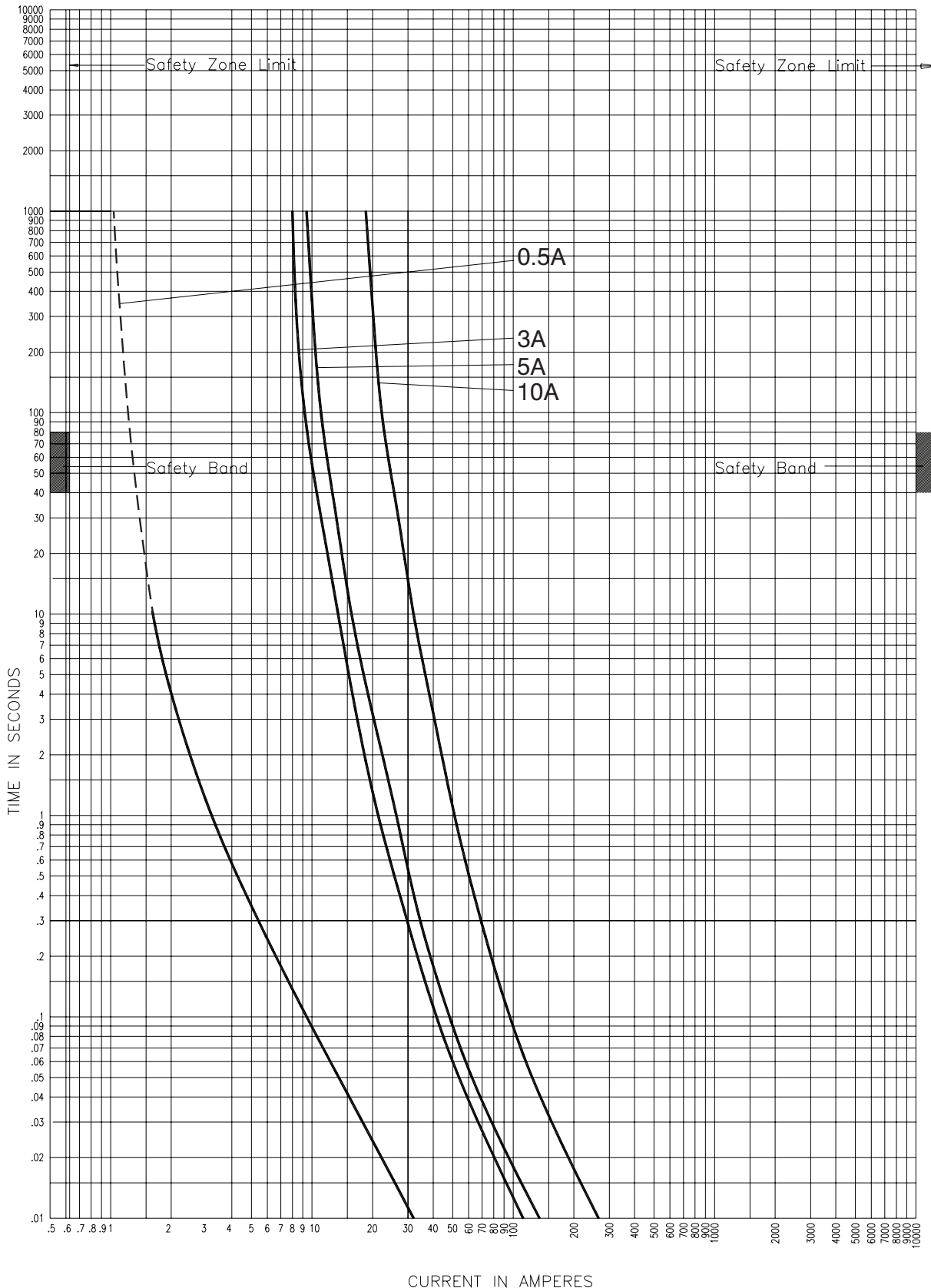

0.5 A fuse melt time in the dotted line region may not be assured due to manufacturing variations. The dotted lines show nominal operation. Some individual fuses may not open until current at 10-second mark is applied.

CURVE 56353206
July 2002
Reference # 563532

8CLPT-_E

8.3kV time-current curves — total clearing for 8CLPT_

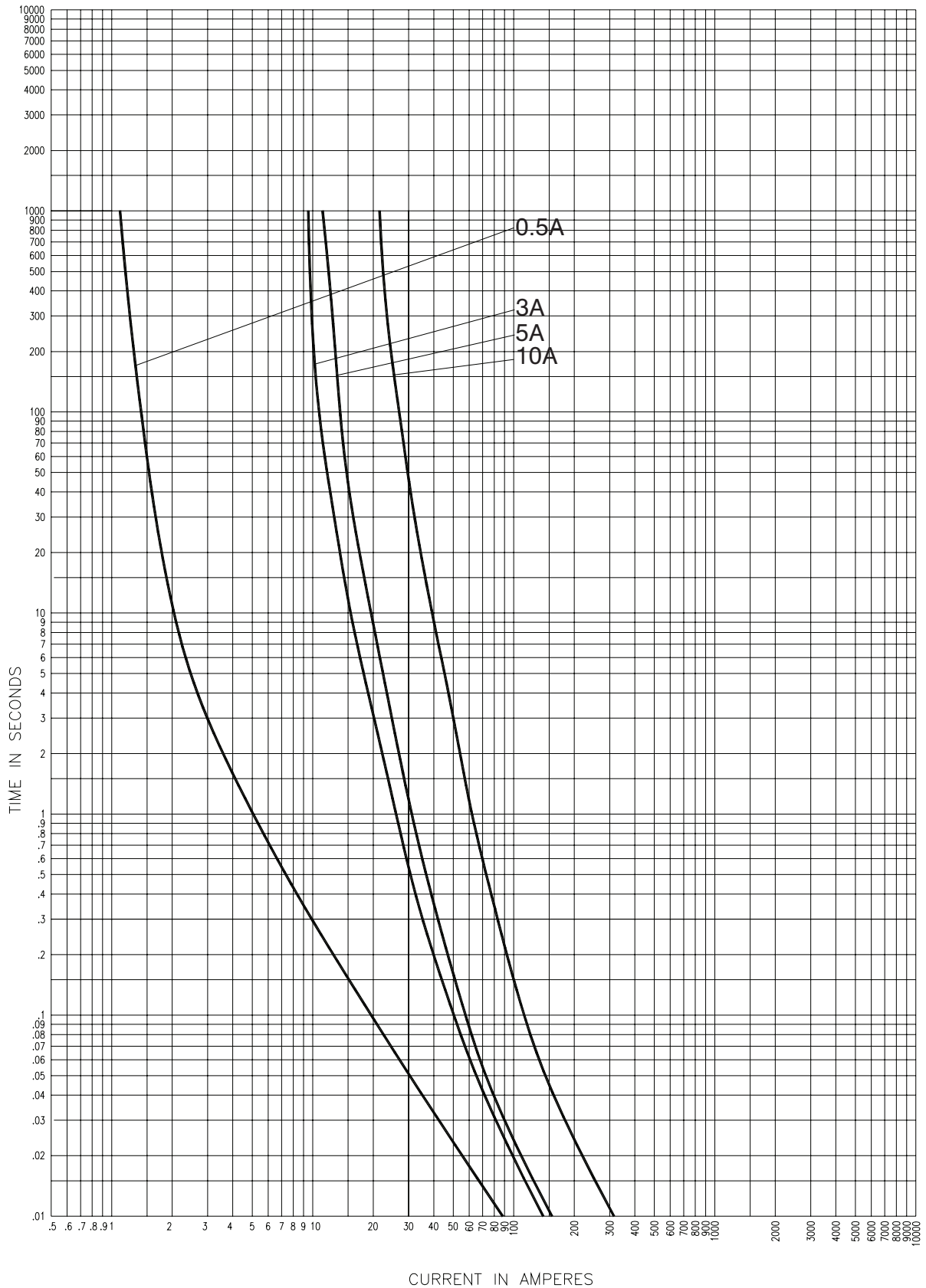

8CLPT-_E

CURVE 56353306
July 2002
Reference # 563533

8.3kV peak let-through curves for 8CLPT_

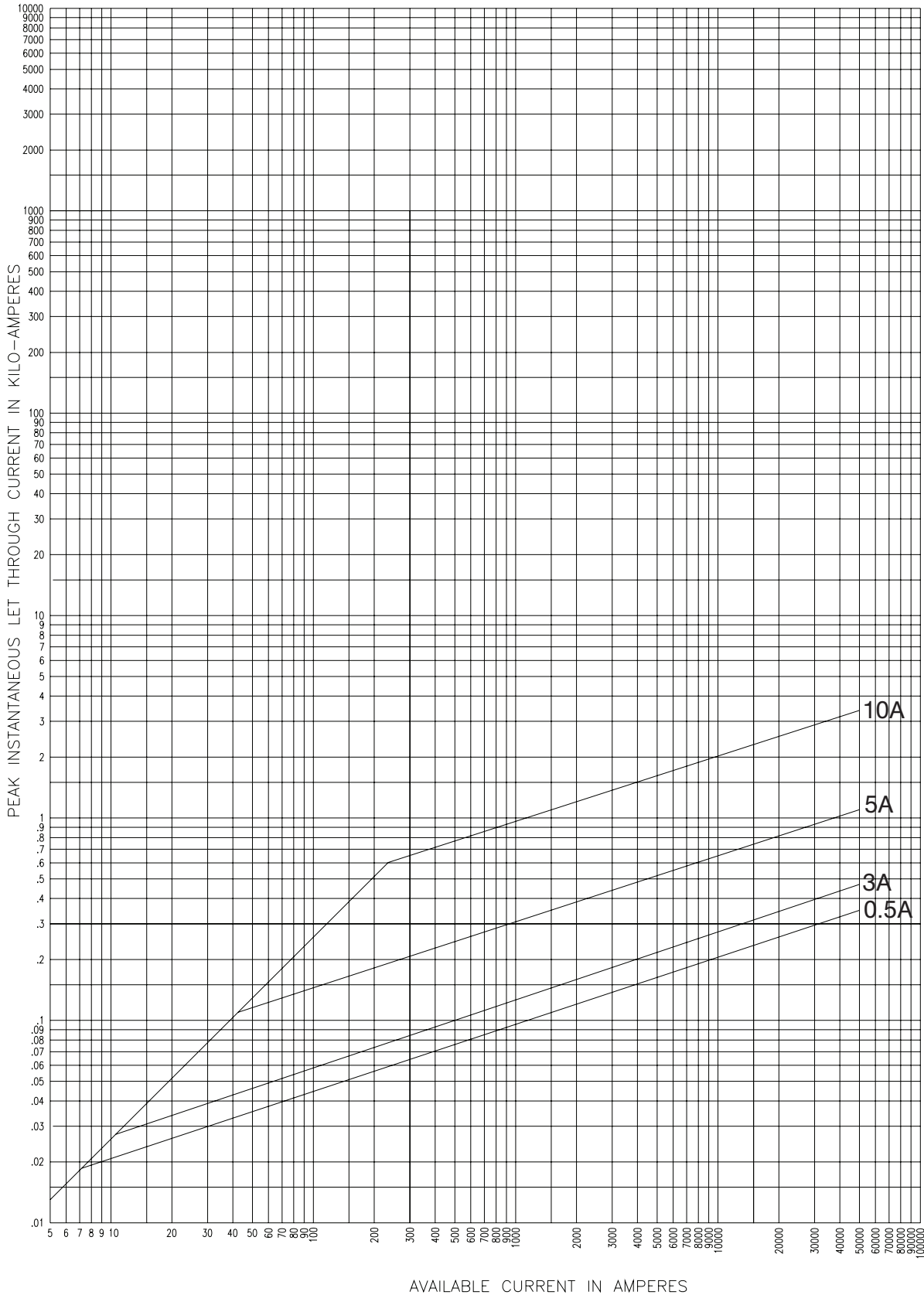

8CLPT-_E

63934001
July 2001
Reference # 639340

8.3kV time-current curves — minimum melting for 8NCLPT_E-A/B

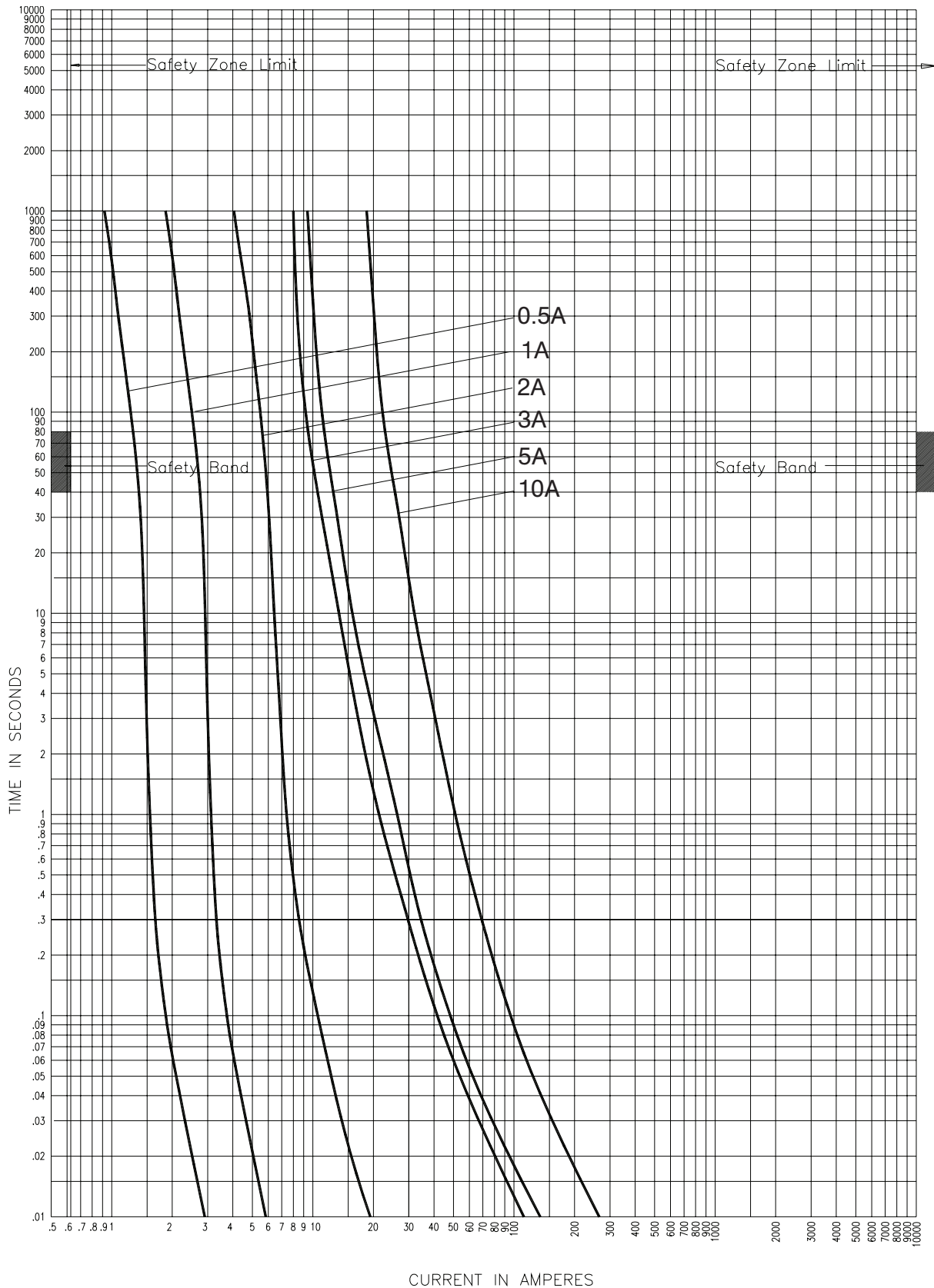

8NCLPT_E-A/B

CURVE 70548303
July 2002
Reference # 705483

8.3kV time-current curves — total clearing for 8NCLPT_E--A/B

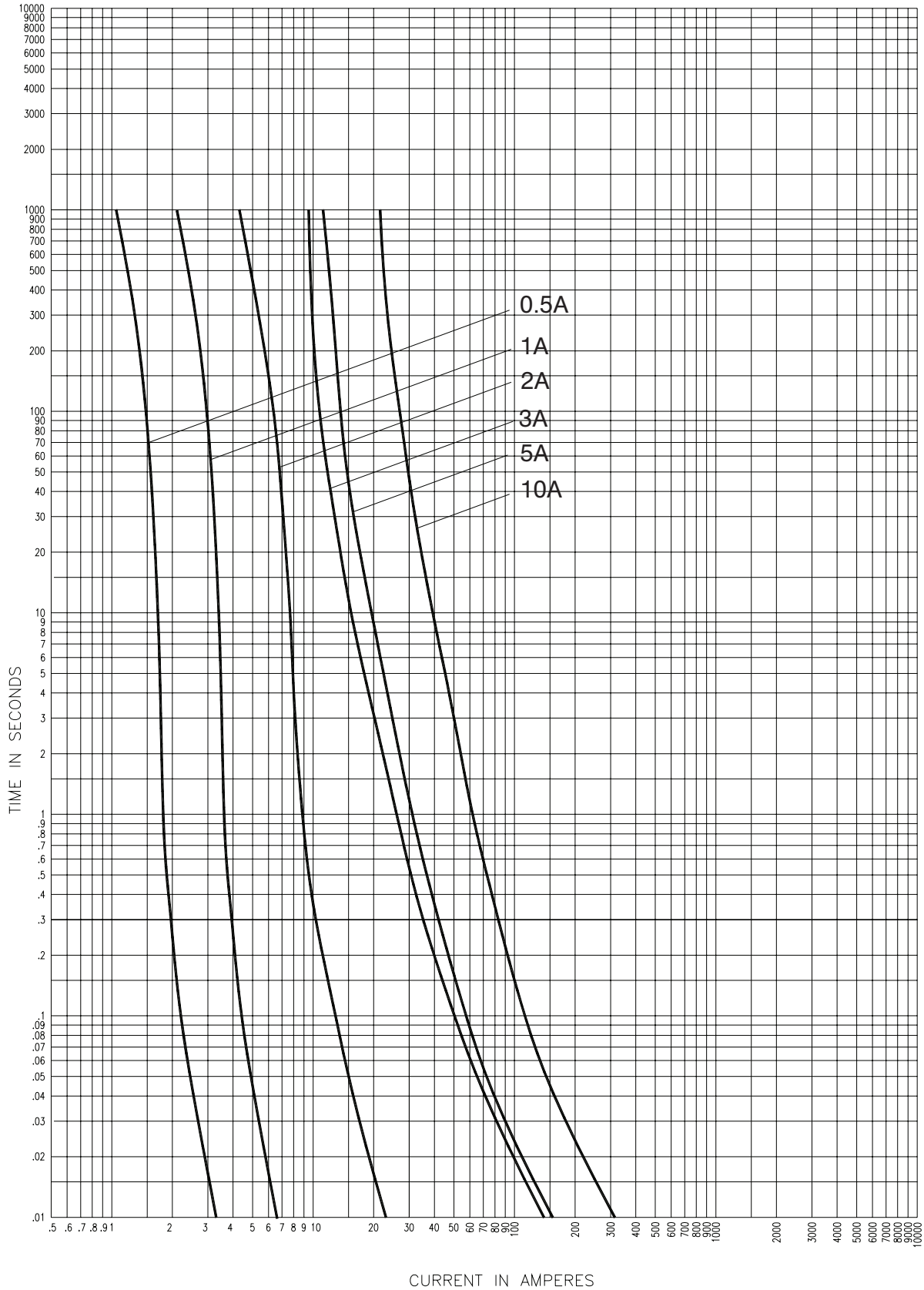

8NCLPT_E-A/B

CURVE 70548403
July 2002
Reference # 563533

8.3kV peak let-through curves for 8NCLPT_E-A/B

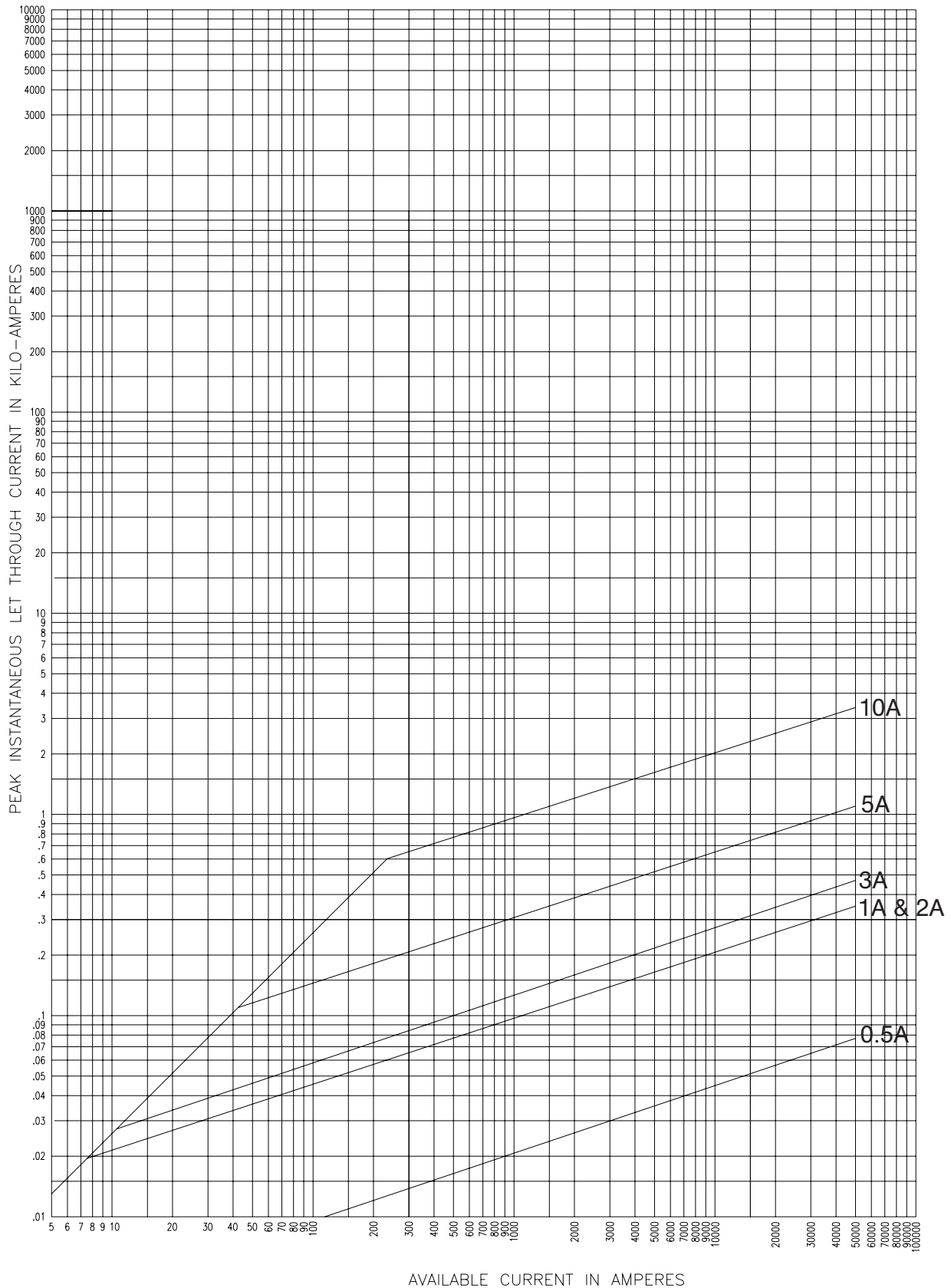

8NCLPT_E-A/B

63934002
July 2001
Reference # 639340

12kV maximum system voltage

Amp rating	Dimensions - in (mm)			Catalog No. (Interrupting rating - kA)		
	Length A	Diameter B	Clip centers C	Indicating	Non-indicating	Recommended fuseclip
2	8.7 (221)	1.6 (41)	7.5 (190)	—	12CAV2 (40)	1A0835
3.15	7.7 (195)	1 (25)	6.5 (165)	—	12ABCNA3.15 (45)	A3354705

Dimensions (see catalog number tables for values)

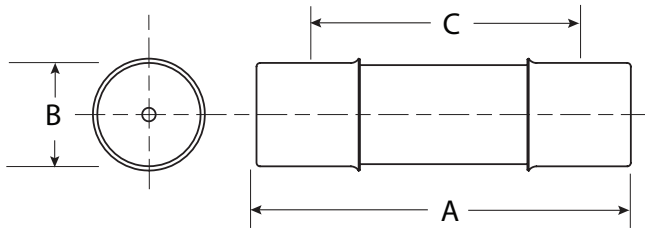

Recommended fuseclips:

Description	Cat. No.
Open fuseclip for 1.0 (25.4mm) dia. fuses	A3354705
Open fuseclip for 1.56 (39.7mm) / 1.6 (40.6mm) dia. fuses	1A0835

12kV time-current curves — minimum melting for 12ABC_ and 12CAV_

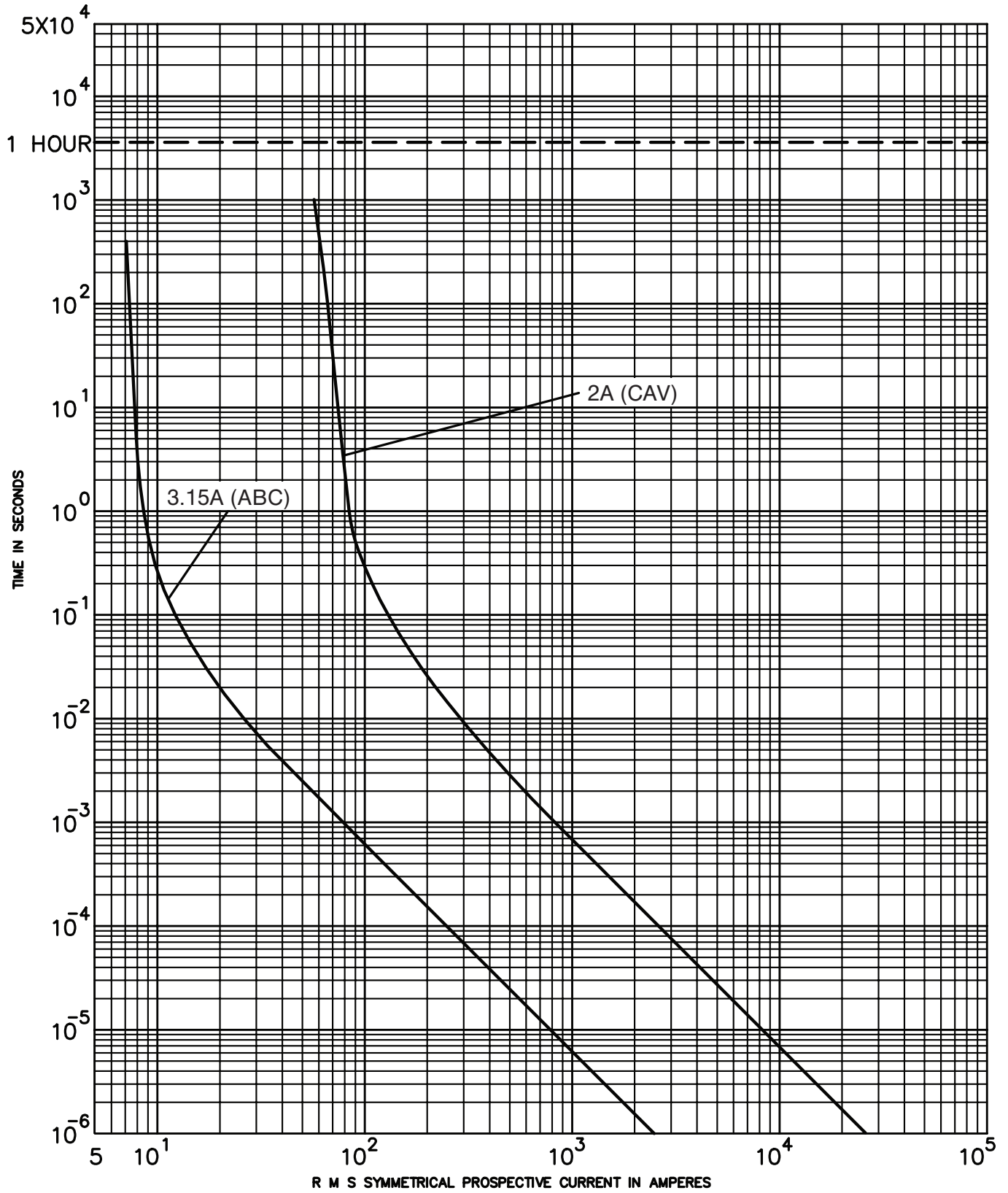

12ABC_, 12CAV_

12kV peak let-through curves for 12ABC_

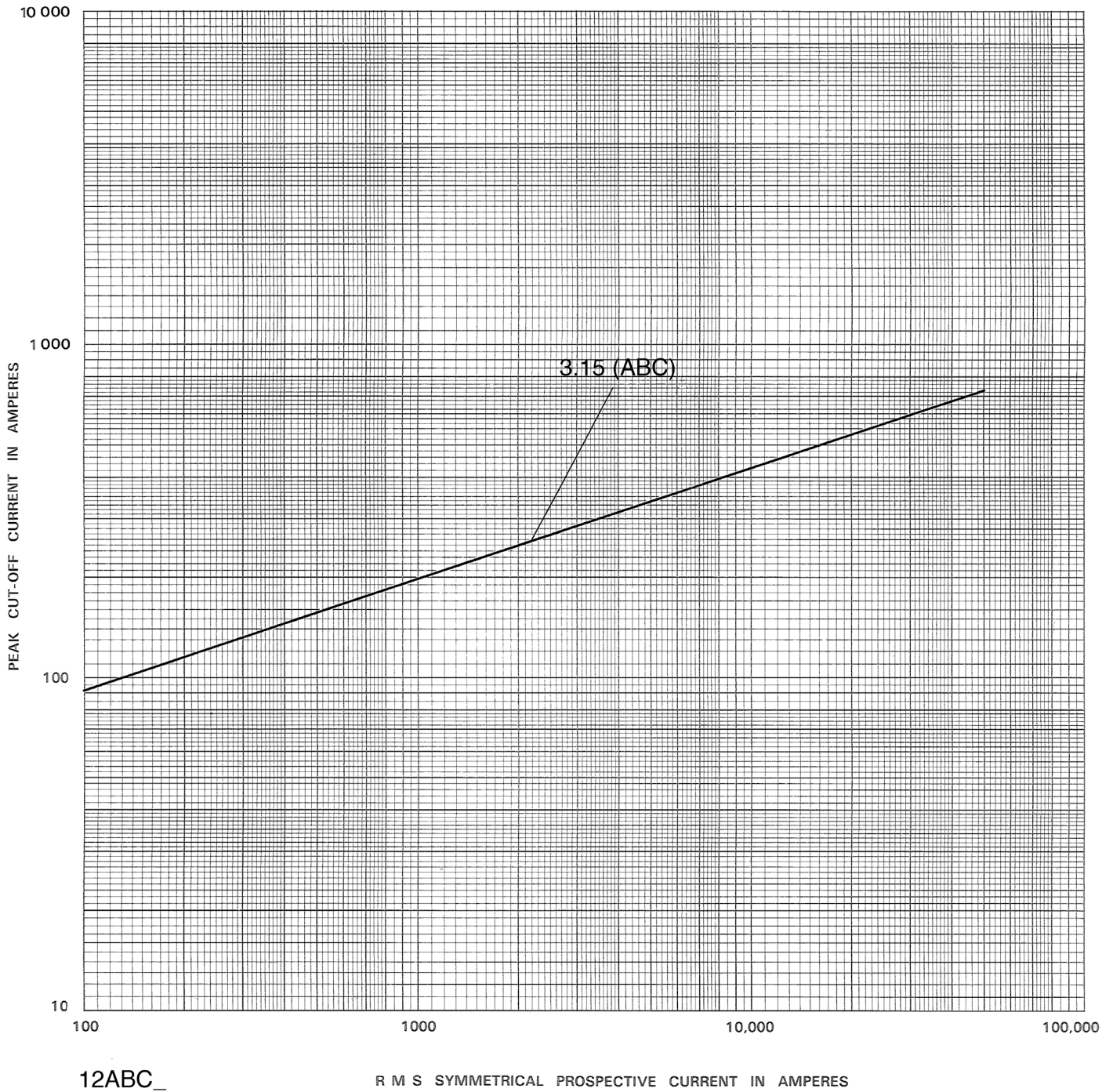

15.5kV maximum system voltage

Amp rating	Dimensions - in (mm)			Catalog No. (Interrupting rating - kA)		Recommended fuseclip
	Length A	Diameter B	Clip centers C	Indicating	Non-indicating	
0.5	12.9 (328)	1.6 (41)	11.5 (292)	15.5CAVH0.5E (80)	15NCLPT-5E-A (63)	1A0835
1	12.9 (328)	1.6 (41)	11.5 (292)	15.5CAVH1E (80)	15NCLPT-1E-A (63)	
2	12.9 (328)	1.6 (41)	11.5 (292)	15.5CAVH2E (80)	15NCLPT-2E-A (63)	
3	12.9 (328)	1.6 (41)	11.5 (292)	—	15.5CAV3E (80)	
3	17.6 (447)	1.6 (41)	16.1 (409)	—	15NCLPT-3E-B (63)	
3	17.6 (447)	1.6 (41)	16.1 (409)	15CLPT-3E-B (63)	—	
5	12.9 (328)	1.6 (41)	11.5 (292)	—	15.5CAV5E (80)	
5	17.6 (447)	1.6 (41)	16.1 (409)	15CLPT-5E-B (80)	15NCLPT-5E-B (63)	
7	12.9 (328)	1.6 (41)	11.5 (292)	—	15.5CAV7E (80)	
10	17.6 (447)	1.6 (41)	16.1 (409)	15CLPT-10E-B (50)	15NCLPT-10E-B (63)	

CLPT Type mountings and hardware 15.5kV maximum (14.4kV nominal)

Amp rating	Fuse mounting type*	BIL (kV)	Catalog number			
			Mounting (Including live parts, end fittings)**		Live parts (including end fittings)**	End fittings (disconnect only)
			Porcelain insulator	Glass-polyester insulator		
0.5-2	Non-disconnect	95	15CLPT-PNM-A	15CLPT-GNM-A	CLPT-NL	—
	Disconnect†	95	15CLPT-PDM-A	15CLPT-GDM-A	CLPT-DL	CLPT-DF
3-10	Non-disconnect	95	15CLPT-PNM-B	15CLPT-GNM-B	CLPT-NL	CLPT-DF
	Disconnect†	95	15CLPT-PDM-B	15CLPT-GDM-B	CLPT-DL	—

* See page 70 for dimensions and diagrams of typical mounting.

** End fittings supplied only when required.

† Disconnect mountings provide a means for fuse extraction only. Do not use a disconnect mounting for load switching or fuse removal while energized.

Dimensions (see catalog number tables for values)

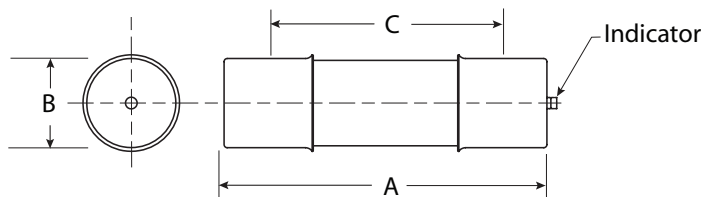

Recommended fuseclips:

Description	Cat. No.
Open fuseclip for 1.56 (39.7mm) / 1.6 (40.6mm) dia. fuses	1A0835

15.5kV time-current curves — minimum melting for 15CLPT_

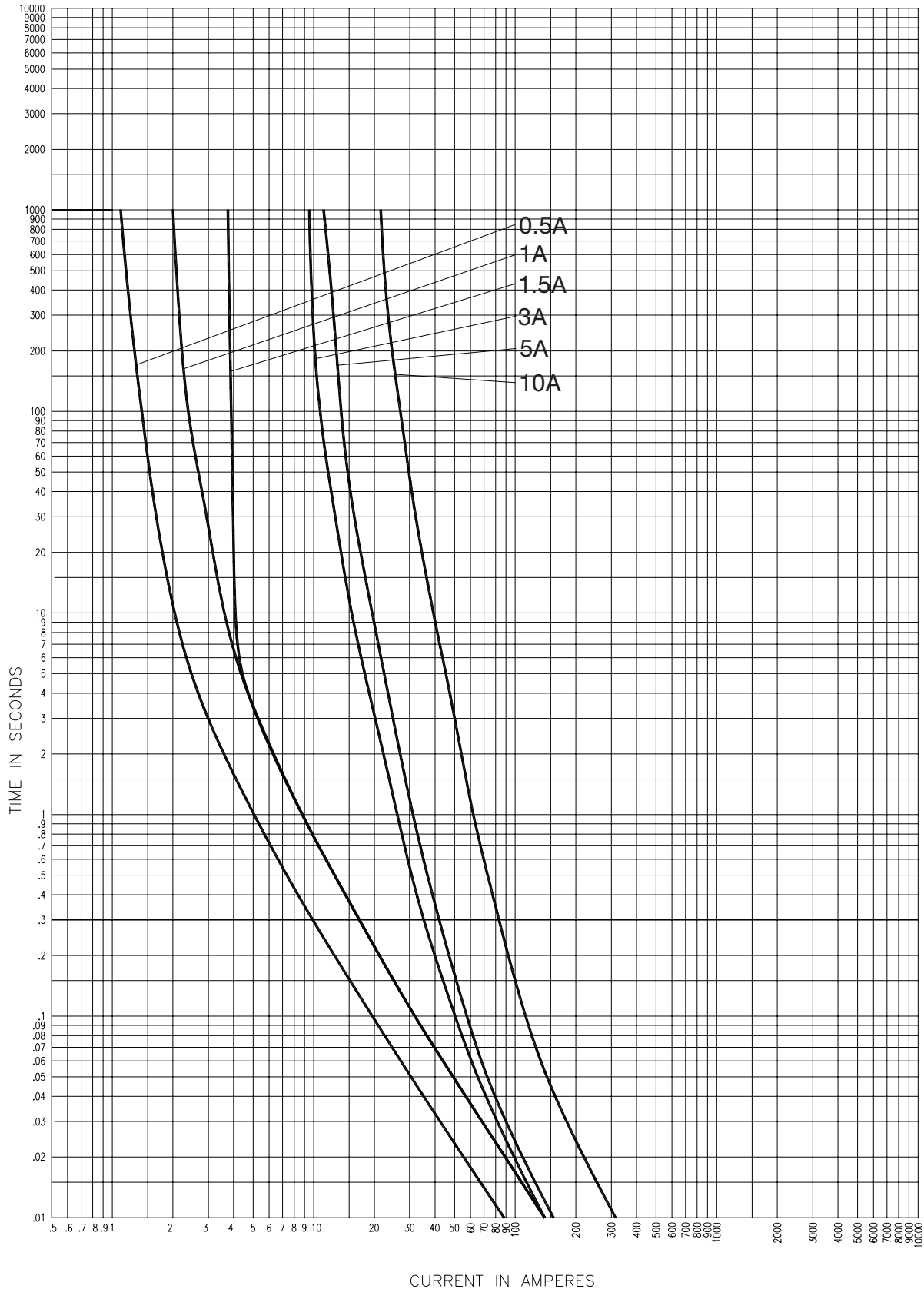

15CLPT_E

CURVE 56353306
July 2002
Reference # 563533

15.5kV time-current curves — total clearing for 15CLPT_

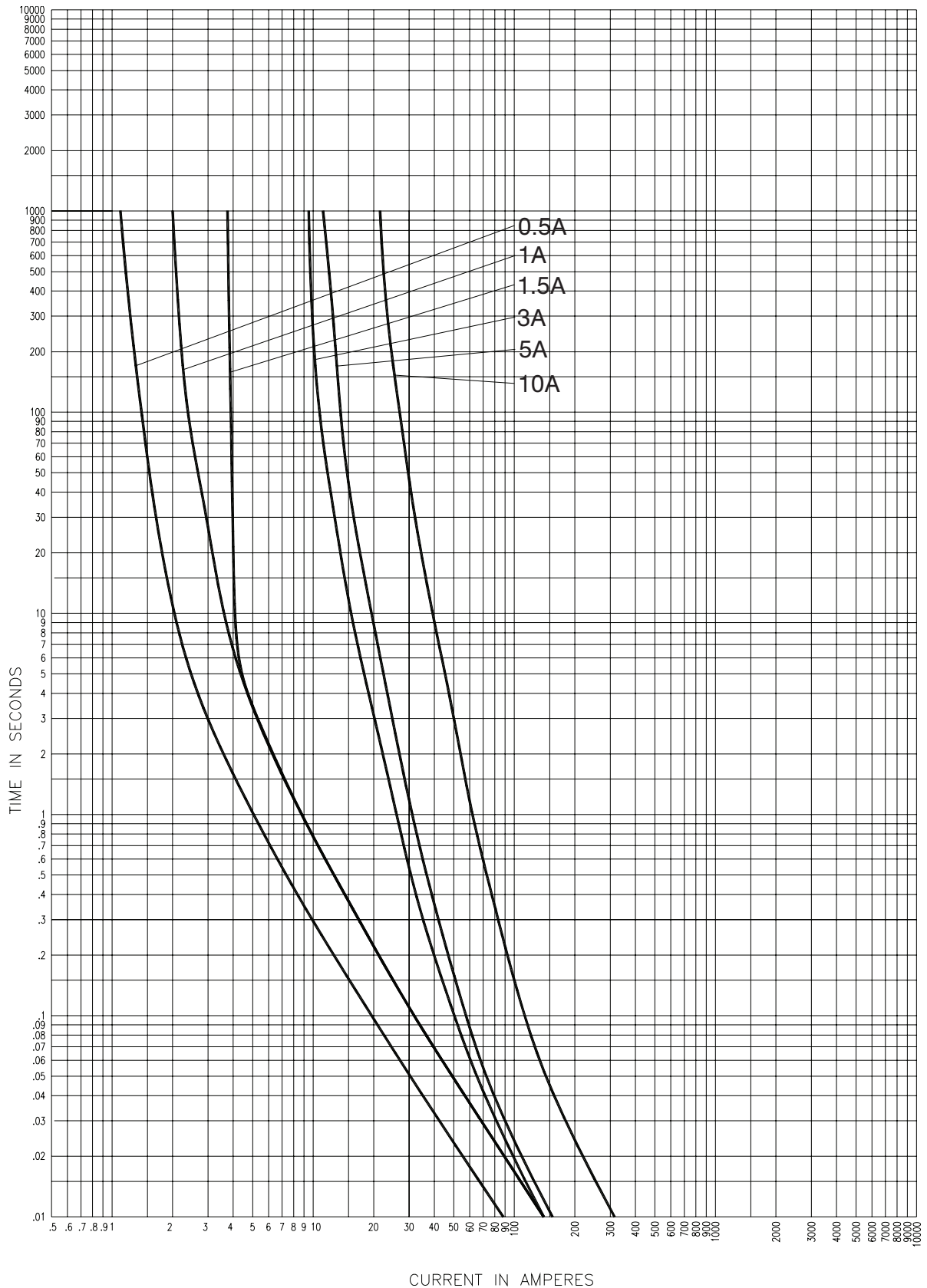

15CLPT_E

CURVE 56353306
July 2002
Reference # 563533

15.5kV peak let-through curves for 15CLPT_

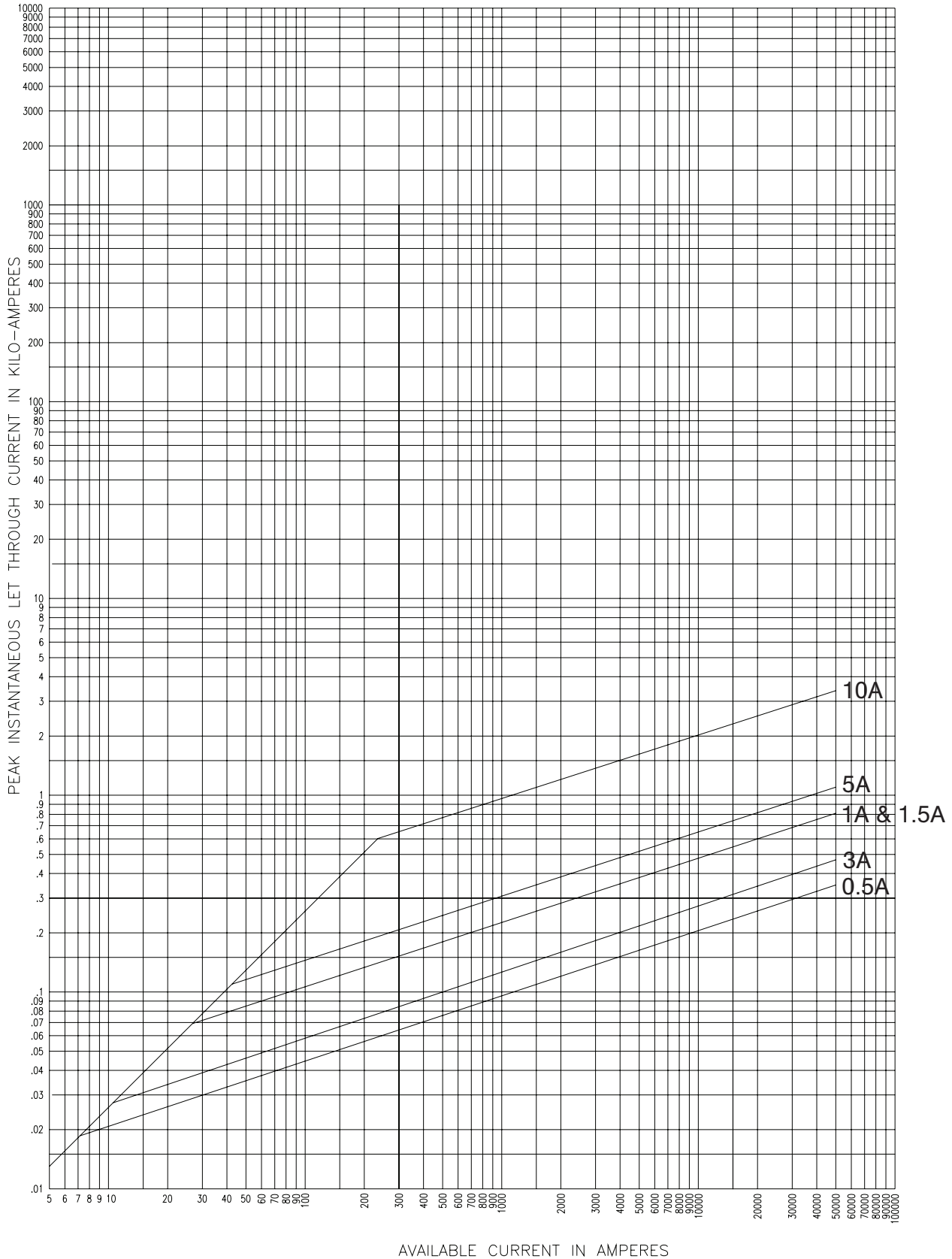

15CLPT-_E

63934001
 July 2001
 Reference # 639340

15.5kV time-current curves — minimum melting for 15NCLPT_

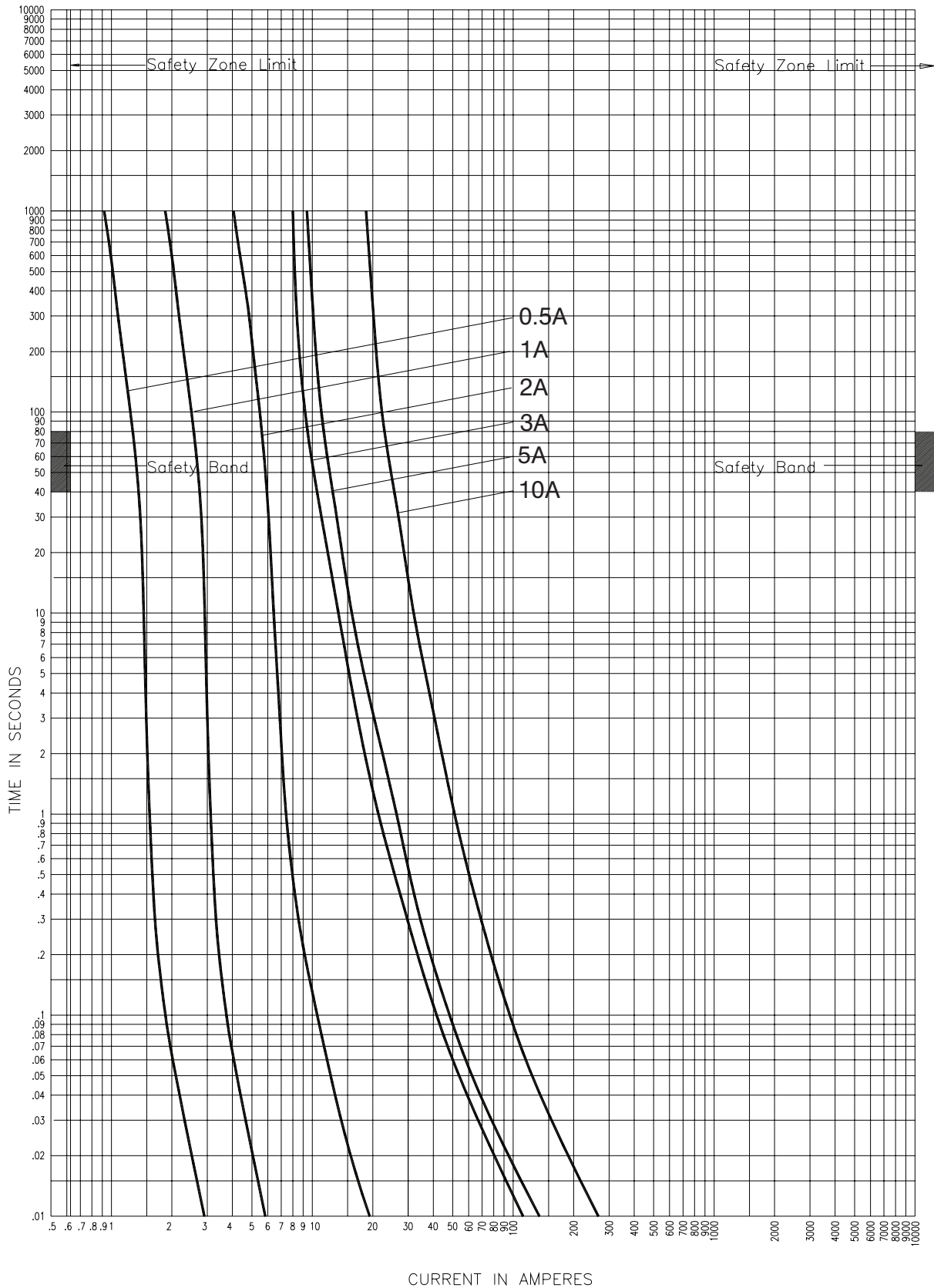

15NCLPT-_E

CURVE 70548303
July 2002
Reference # 705483

15.5kV Time-current curves — total clearing for 15NCLPT_

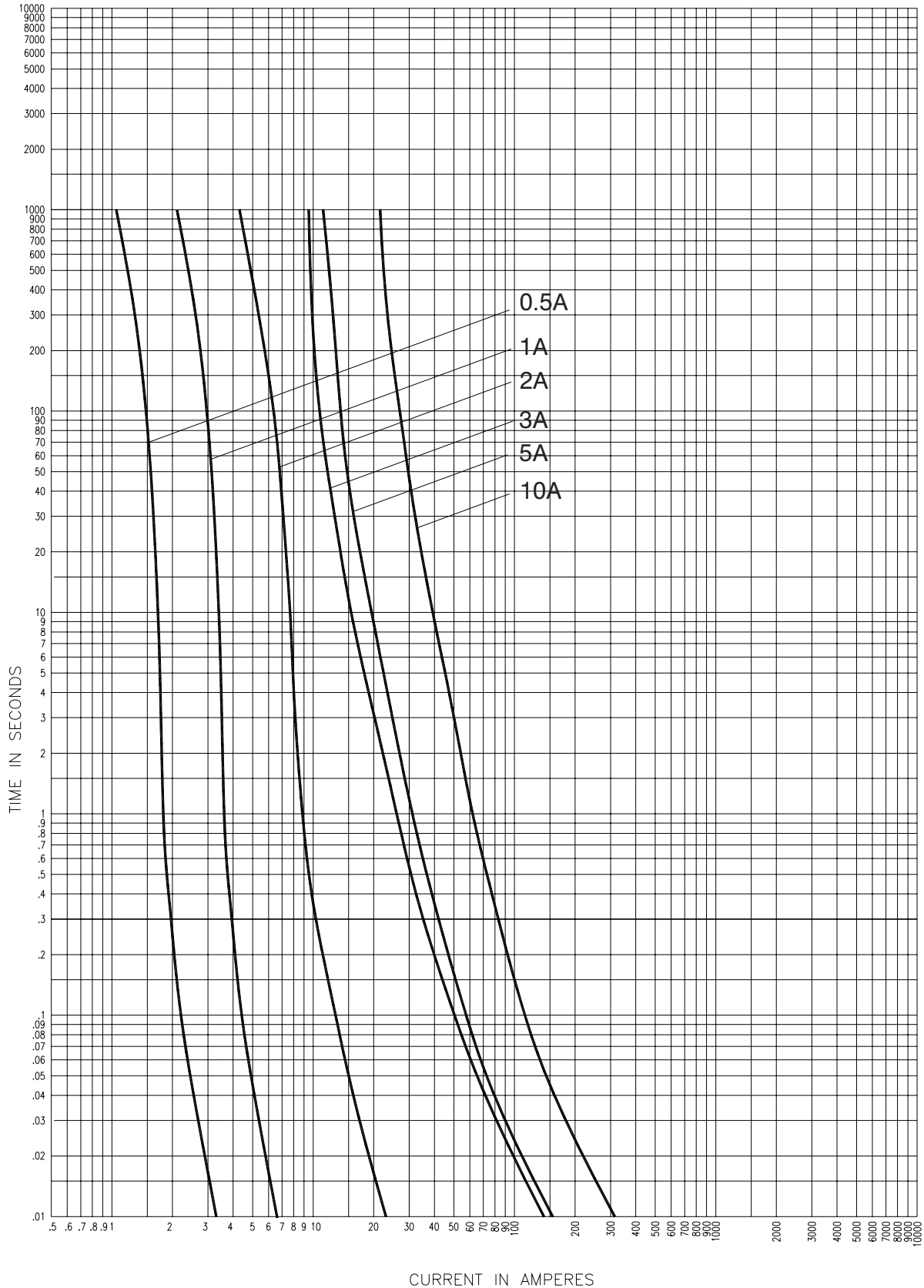

15NCLPT-_E

CURVE 70548403
July 2002
Reference # 563533

15.5kV Peak let-through curves for 15NCLPT_

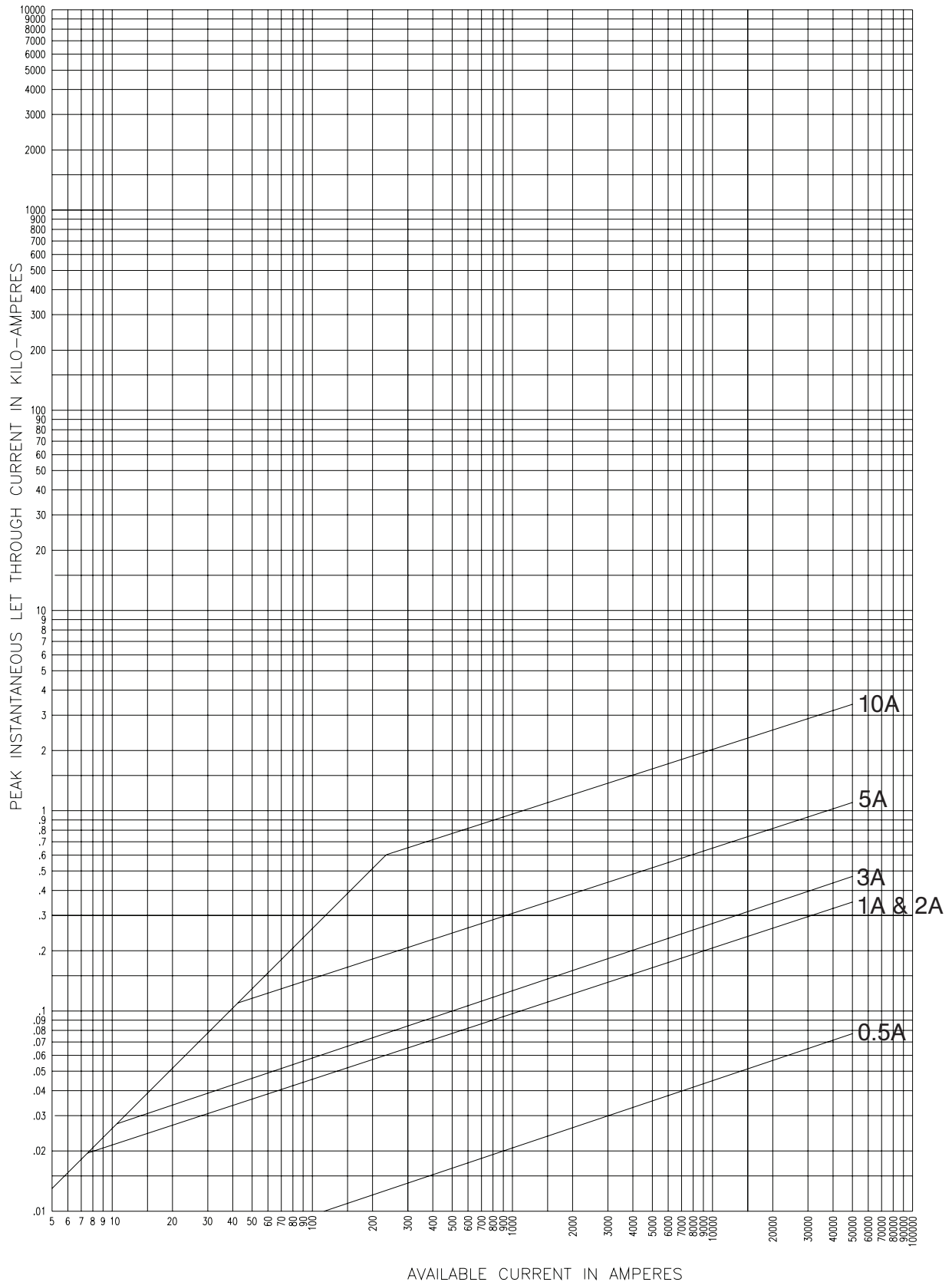

15NCLPT-_E

63934002
July 2001
Reference # 639340

15.5kV time-current curves — minimum melting for 15.5CAV_ and 15.5CAVH_

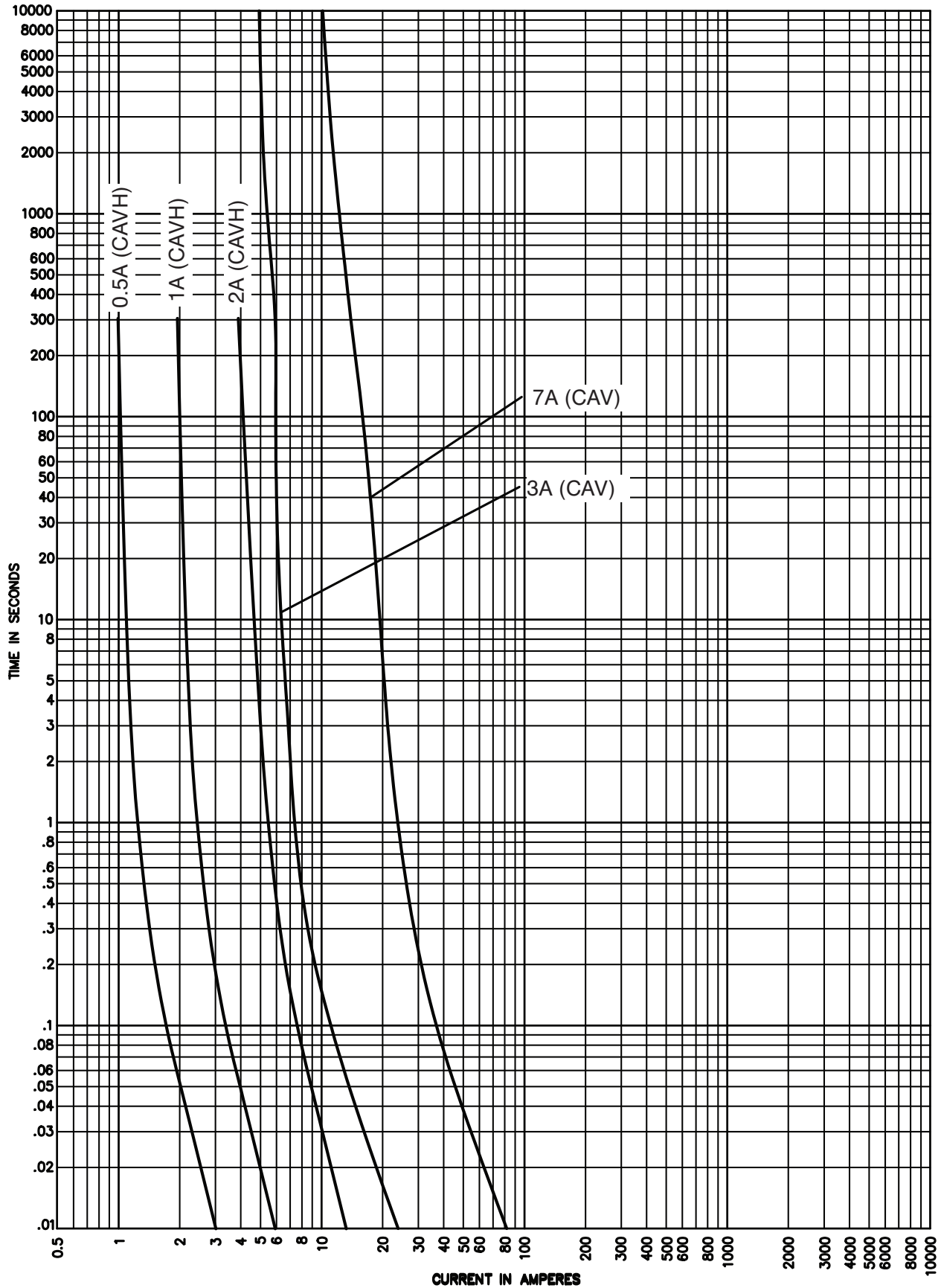

15.5CAV_, 15.5CAVH_

15.5kV time-current curves — total clearing for 15.5CAVH_

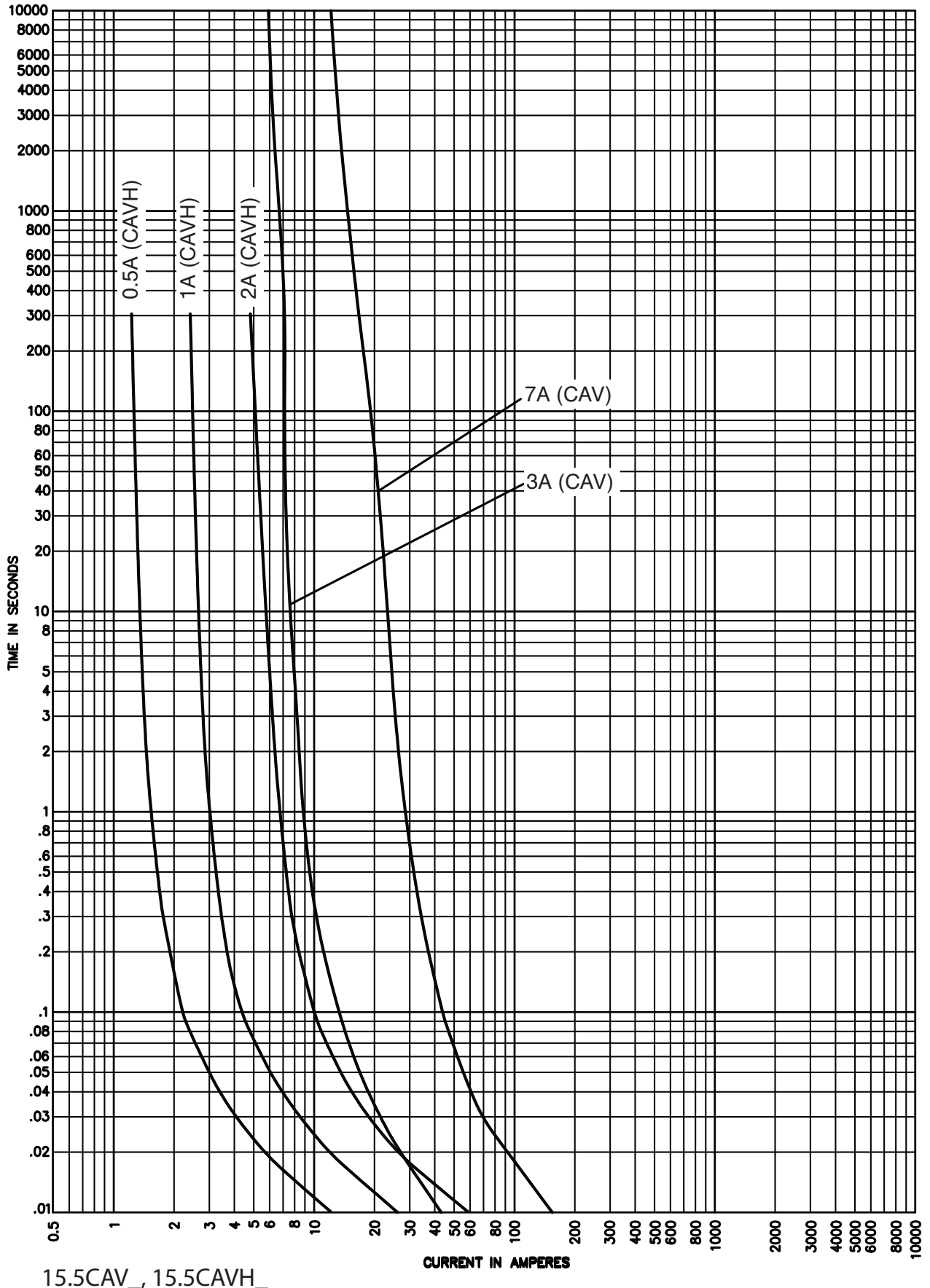

15.5CAV_ , 15.5CAVH_

15.5kV peak let-through curves for 15.5CAVH_

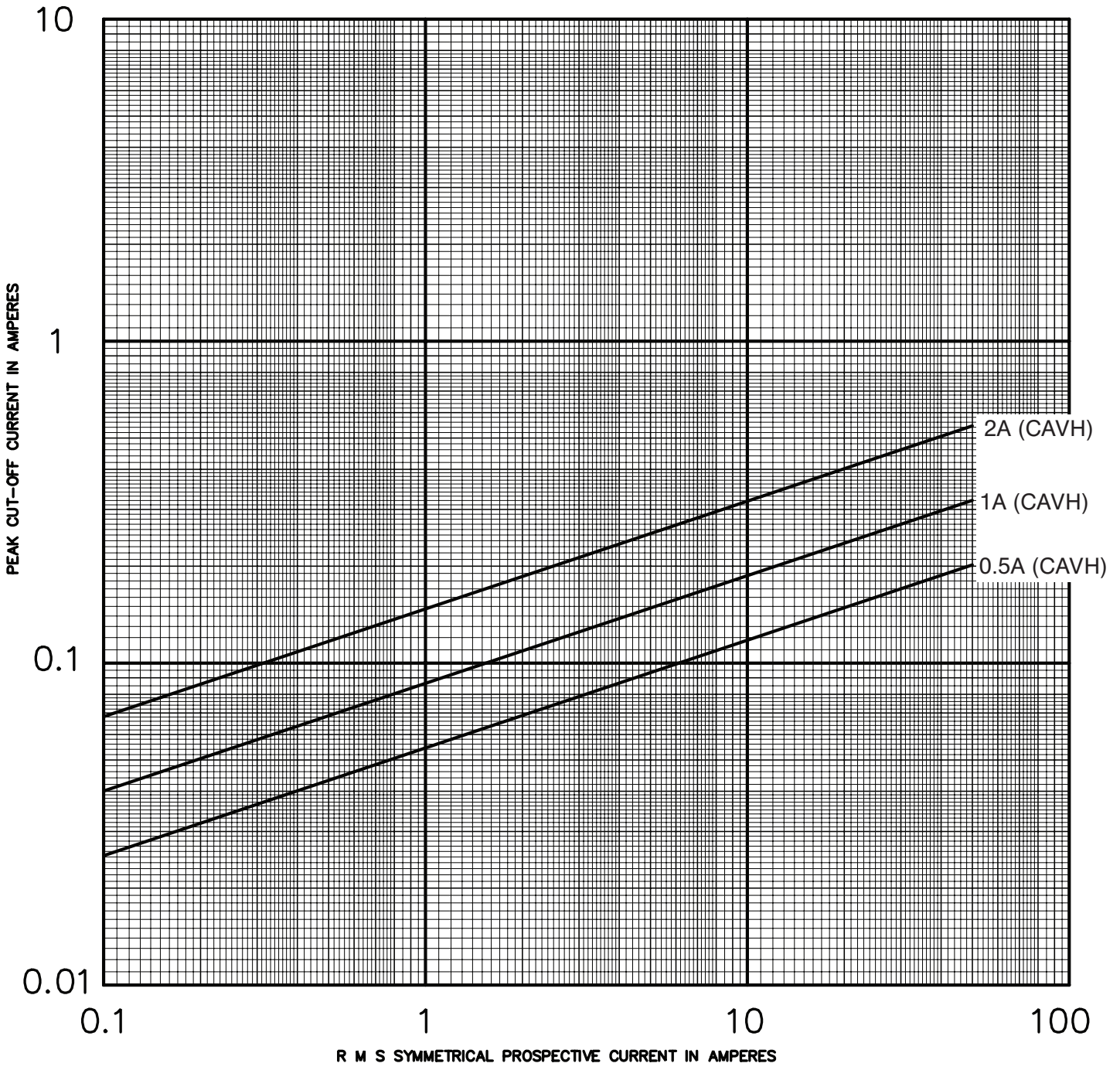

15.5CAVH_

17.5kV maximum system voltage

Amp rating	Dimensions - in (mm)			Catalog No. (Interrupting rating - kA)		
	Length A	Diameter B	Clip centers C	Indicating	Non-indicating	Recommended fuseclip
2	8.7 (221)	1.6 (41)	7.5 (190)	—	17.5CAV2 (40)	1A0835
4				—	17.5CAV4 (40)	
6				—	17.5CAV6 (40)	
10				—	17.5CAV10 (40)	

Dimensions (see catalog number tables for values)

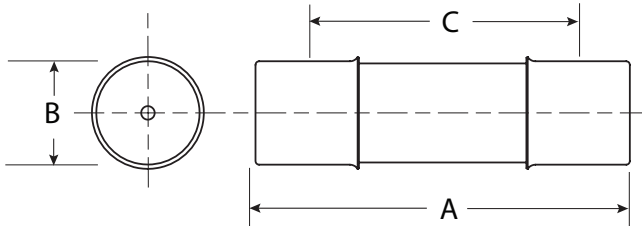

Recommended fuseclips:

Description	Cat. No.
Open fuseclip for 1.56 (39.7mm) / 1.6 (40.6mm) dia. fuses	1A0835

17.5kV time-current curves — minimum melting for 17.5CAV_

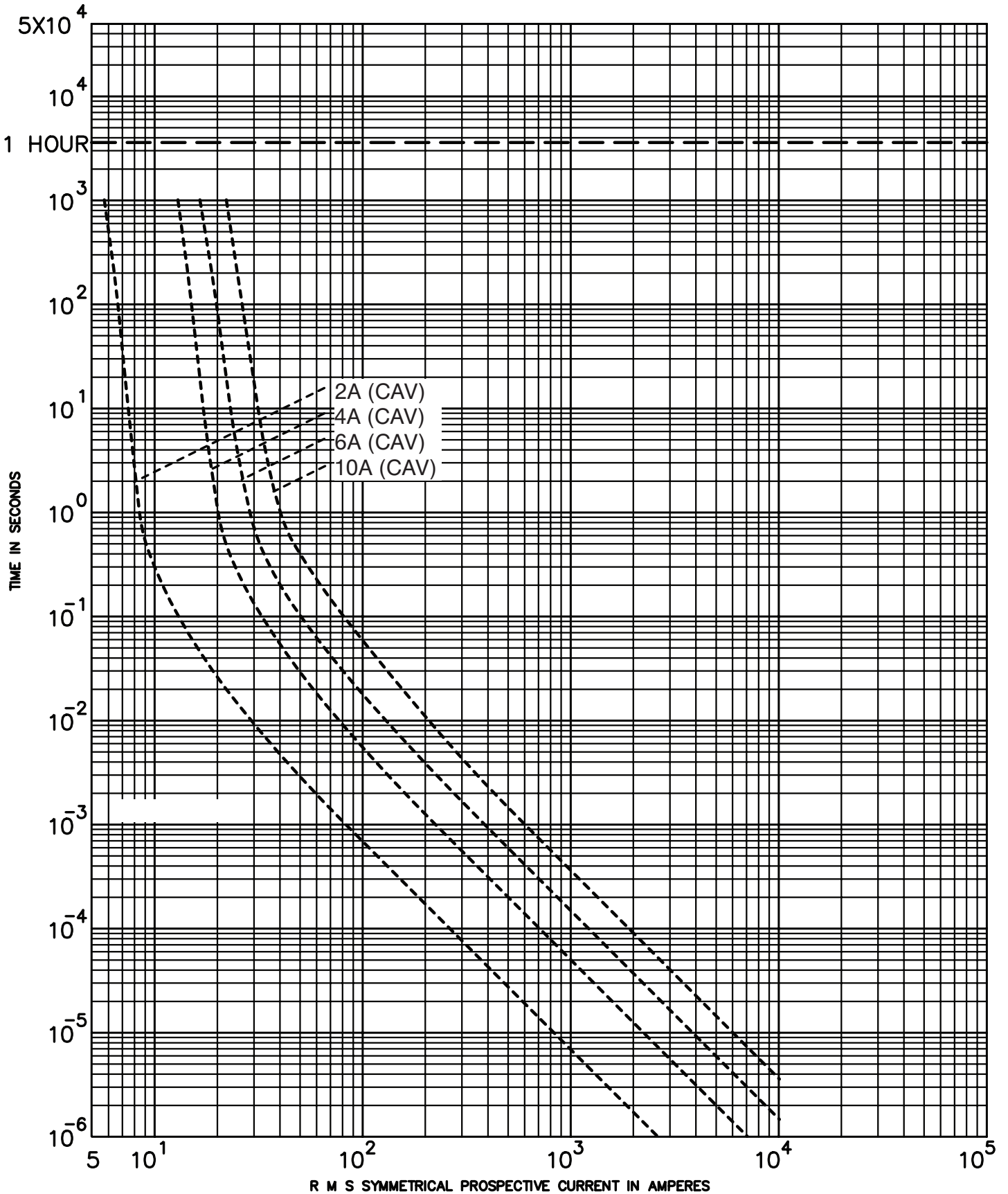

7.5CAV_

24kV maximum system voltage

Amp rating	Dimensions - in (mm)			Catalog No. (Interrupting rating - kA)		
	Length A	Diameter B	Clip centers C	Indicating	Non-indicating	Recommended fuseclip
2				—	24CAV2 (40)	
3	13.49 (340)	1.6 (41)	12.2 (310)	—	24CAV3 (40)	1A0835
4				—	24CAV4 (40)	

Dimensions (see catalog number tables for values)

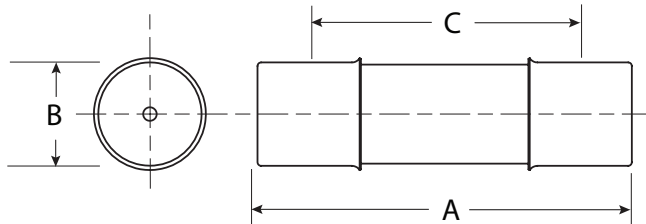

Recommended fuseclips:

Description	Cat. No.
Open fuseclip for 1.56 (39.7mm) / 1.6 (40.6mm) dia. fuses	1A0835

24kV time-current curves — minimum melting for 24CAV_

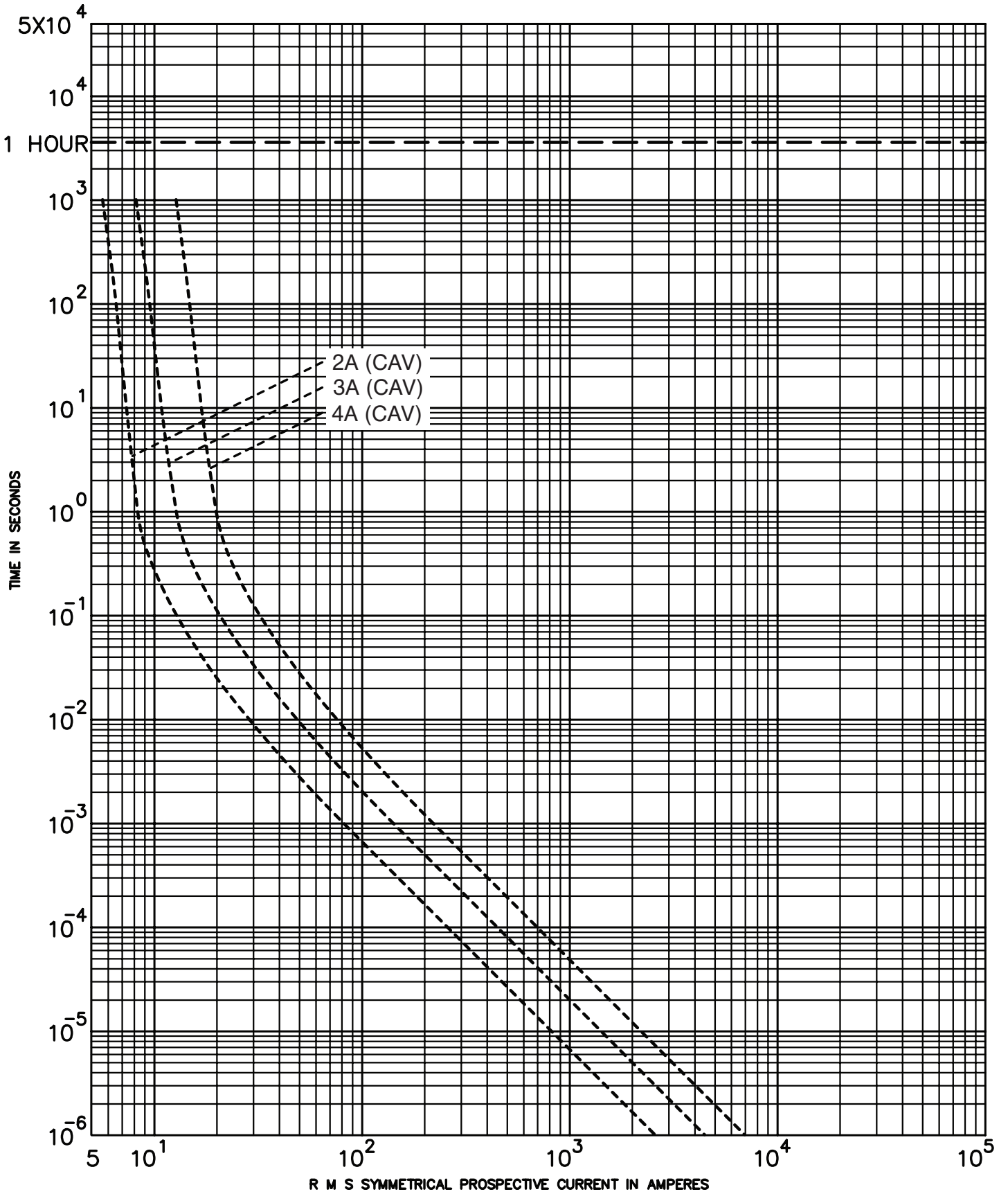

24CAV_

25.5kV maximum system voltage

Amp rating	Dimensions - in (mm)			Catalog No. (interrupting rating - kA)		Recommended fuseclip
	Length A	Diameter B	Clip centers C	Indicating	Non-indicating	
0.5	17.6 (447)	1.6 (41)	16.1 (410)	25CLPT.5E (44) [†]	—	1A0835
1	17.6 (447)	1.6 (41)	16.1 (410)	25CLPT-1E (44) [†]	—	

[†] Does not comply with ANSI C37.46 for "E" rating.

CLPT Type Mountings and Hardware 25.5kV Maximum (23kV Nominal)

Amp rating	Fuse mounting type*	BIL (kV)	Catalog number			
			Mounting (including live parts, end fittings)**		Live parts (including end fittings)**	End fittings (disconnect only)
			Porcelain insulator	Glass-polyester insulator		
0.5-1	Non-disconnect	150	25CLPT-PNM-A	—	25CLPT-NL	—
	Disconnect	150	25CLPT-PDM-A	—	25CLPT-DL	CLPT-DF

* See page 70 for dimensions and diagrams of typical mounting.

** End fittings supplied only when required.

[†] Disconnect mountings provide a means for fuse extraction only. Do not use a disconnect mounting for load switching or fuse removal while energized.

Dimensions (see catalog number tables for values)

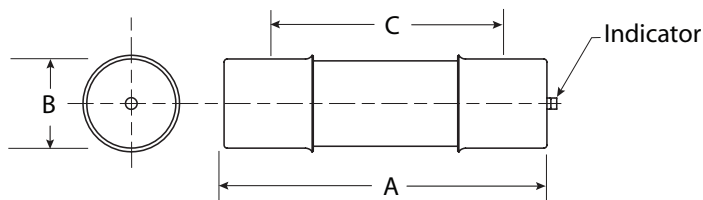

Recommended fuseclips:

Description	Cat. No.
Open fuseclip for 1.56 (39.7mm) / 1.6 (40.6mm) dia. fuses	1A0835

25.5kV time-current curves — minimum melting for 25CLPT_

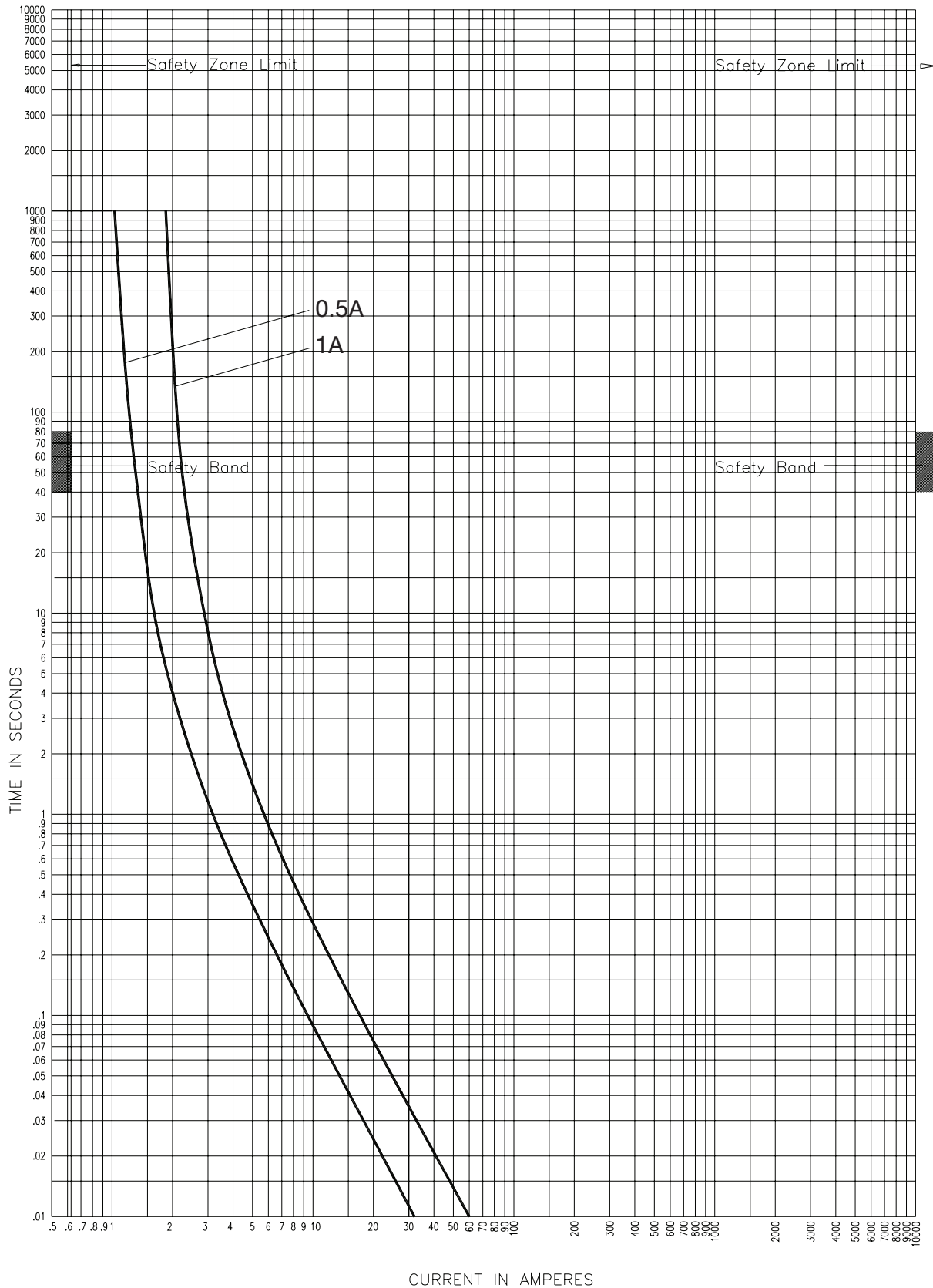

25CLPT-_E

CURVE 56353208
July 2002
Reference # 563532

25.5kV time-current curves — total clearing for 25CLPT_

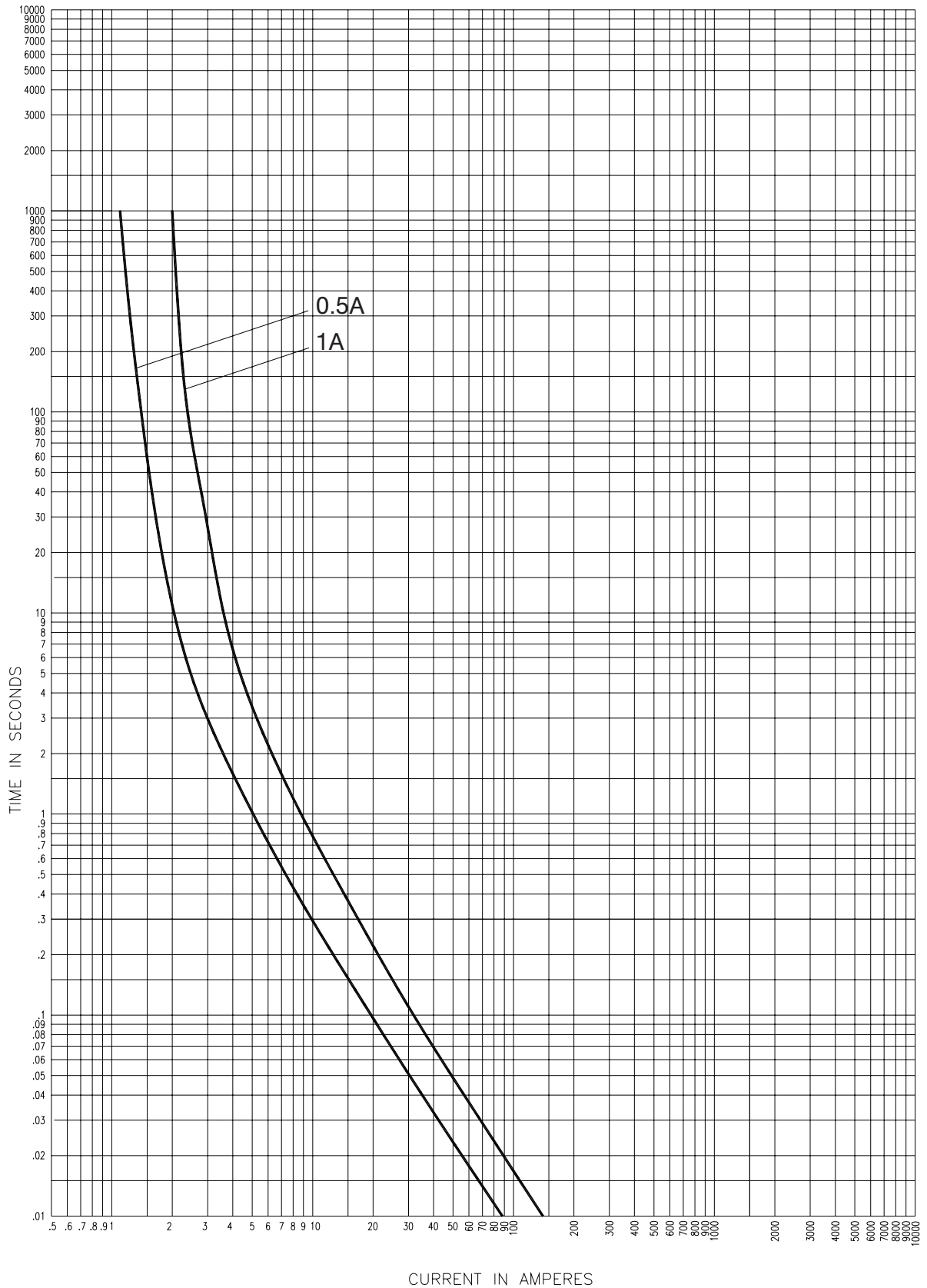

25CLPT-_E

CURVE 56353308
July 2002
Reference # 563533

25.5kV Peak let-through curves for 25CLPT_

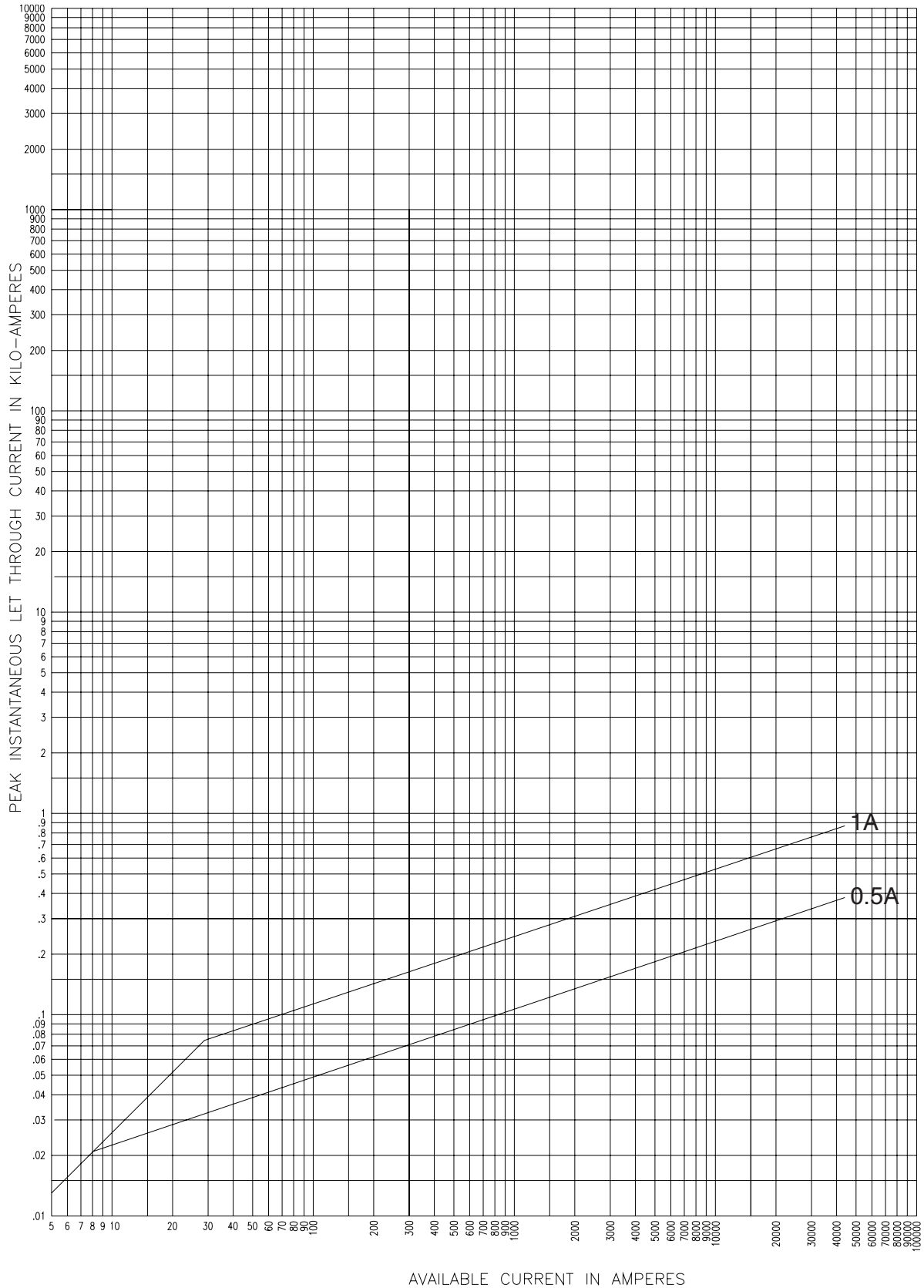

25CLPT_E

CURVE 63933901
 July 2001
 Reference # 639339

36kV maximum system voltage

Amp rating	Dimensions - in (mm)			Catalog No. (Interrupting rating - kA)		Recommended fuseclip
	Length A	Diameter B	Clip centers C	Indicating	Non-indicating	
2	17.3 (439)	1.6 (41)	16.1 (410)	—	36CAV2 (40)	1A0835
4				—	36CAV4 (40)	

Dimensions (see catalog number tables for values)

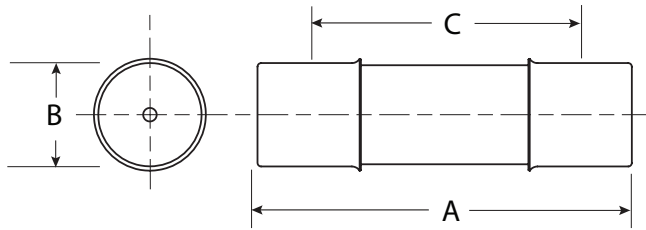

Recommended fuseclips:

Description	Cat. No.
Open fuseclip for 1.56 (39.7mm) / 1.6 (40.6mm) dia. fuses	1A0835

36kV Time-current curves — minimum melting for 36CAV_

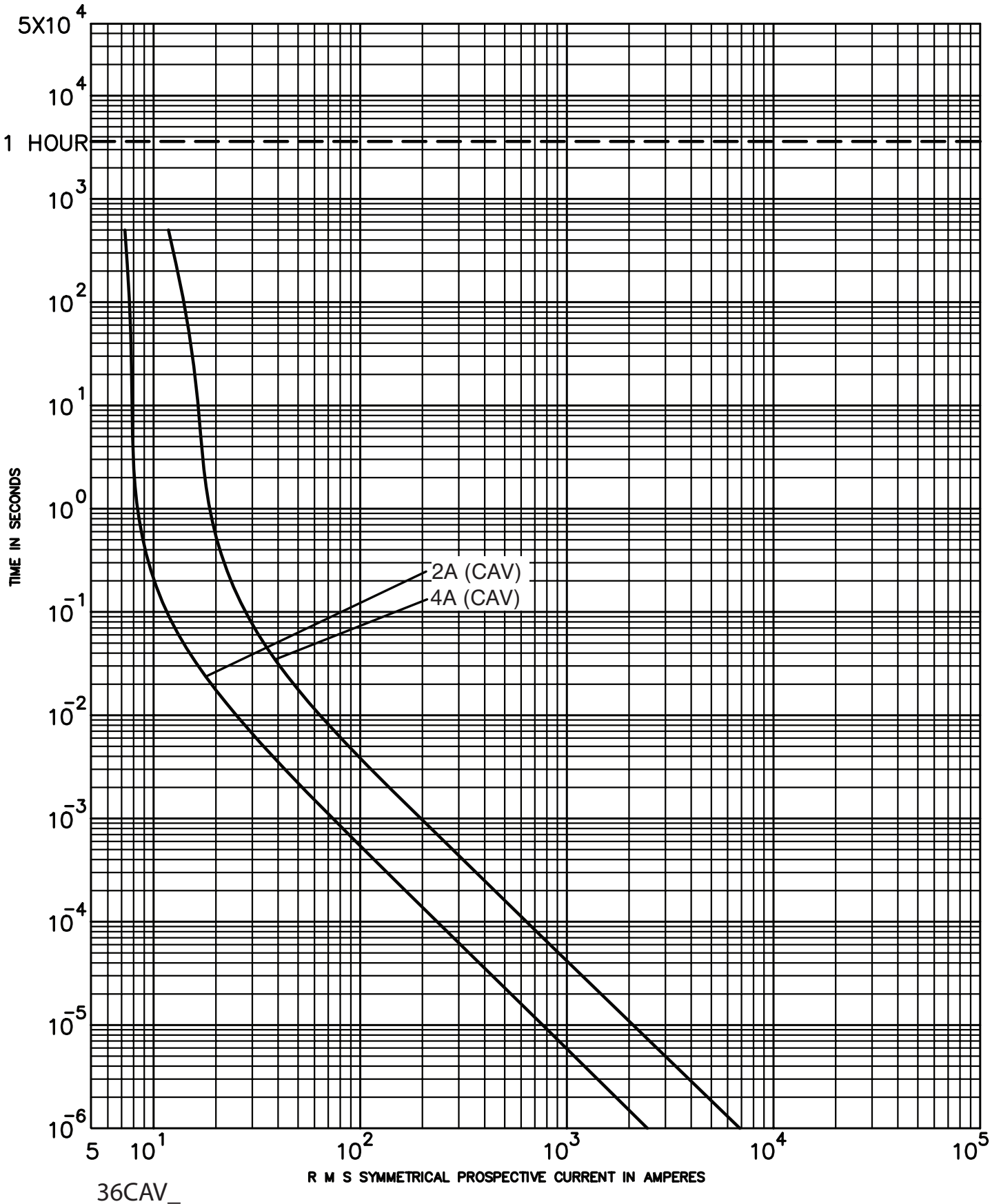

38kV maximum system voltage

Amp rating	Dimensions - in (mm)			Catalog No. (interrupting rating - kA)		
	Length A	Diameter B	Clip centers C	Indicating	Non-indicating	Recommended fuseclip
0.5	17.3 (439)	1.6 (41)	16.1 (409)	38CAVH0.5E (38)	—	
0.5	18.6 (472)	1.6 (41)	17.1 (434)	38CLPT-0.5E (44) [†]	—	
1	17.3 (439)	1.6 (41)	16.1 (409)	38CAVH1E (38)	—	1A0835
2	17.3 (439)	1.6 (41)	16.1 (409)	38CAVH2E (38)	—	
4	17.3 (439)	1.6 (41)	16.1 (409)	—	38CAV4E (38)	

[†] Does not comply with ANSI C37.46 for “E” rating.

CLPT Type Mountings and Hardware 38kV Maximum (34.5kV Nominal)

Amp rating	Fuse mounting type	Catalog number			
		Mounting (including Live Parts, End Fittings)*		Live Parts (including end fittings)*	End fittings (disconnect only)
		Porcelain insulator	Glass-polyester insulator		
0.5	Disconnect [†]	Not applicable	Not applicable	25CLPT-NL	CLPT-DF
	Non-disconnect	Not applicable	Not applicable	25CLPT-DL	—

* End fittings supplied only when required.

[†] Disconnect mountings provide a means for fuse extraction only. Do not use a disconnect mounting for load switching or fuse removal while energized.

Dimensions (see catalog number tables for values)

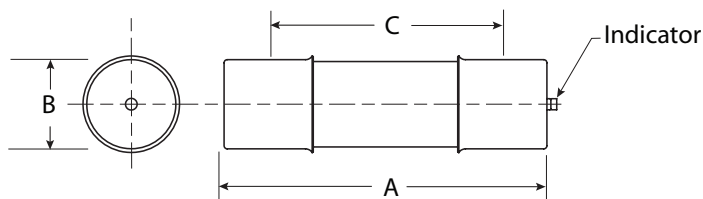

Recommended fuseclip:

Description	Cat. No.
Open fuseclip for 1.56 (39.7mm) / 1.6 (40.6mm) dia. fuses	1A0835

38kV time-current curves — minimum melting for 38CAV_ and 38CAVH

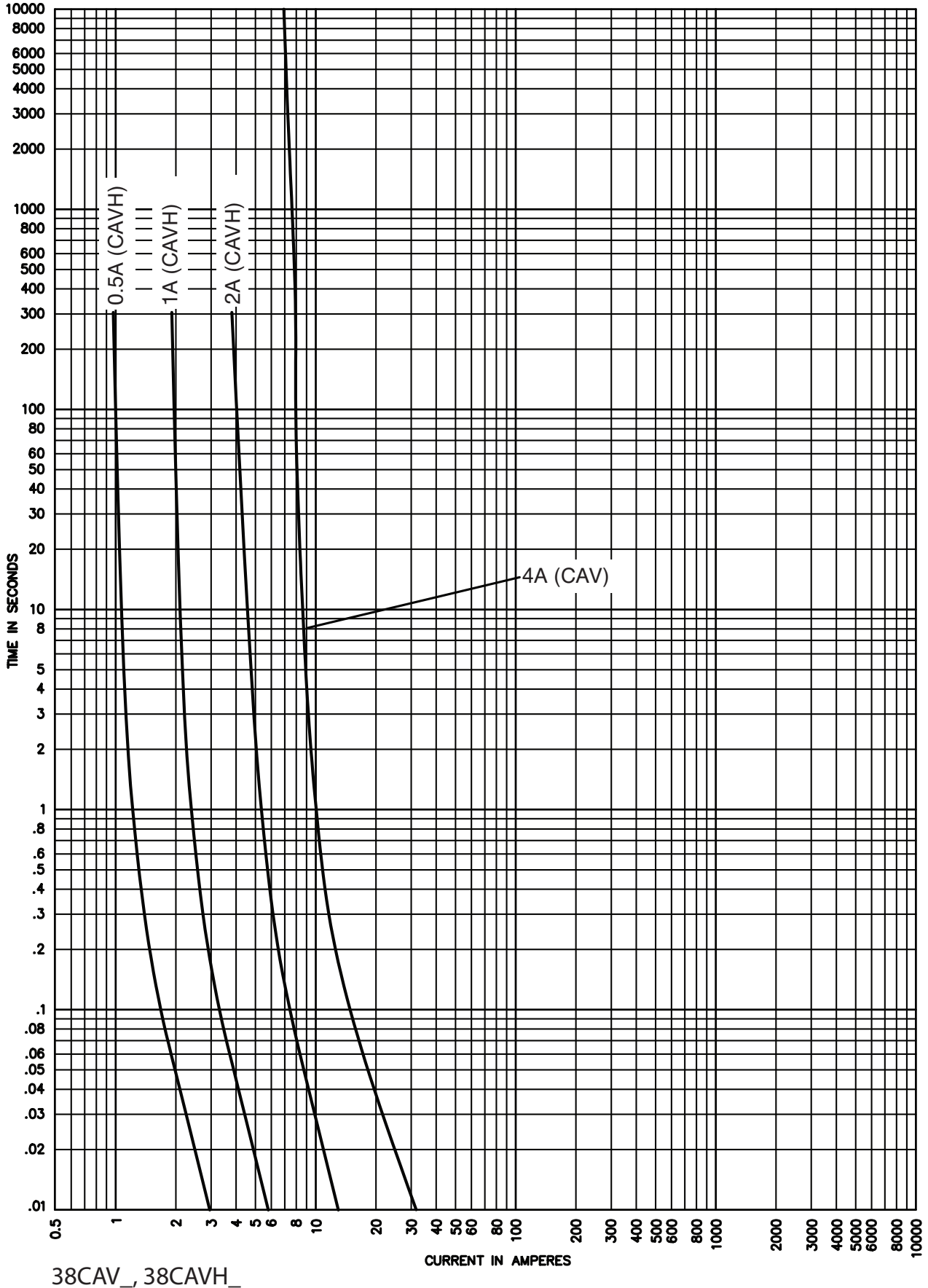

38CAV_, 38CAVH_

38kV time-current curves — total clearing for 38CAV_ and 38CAVH

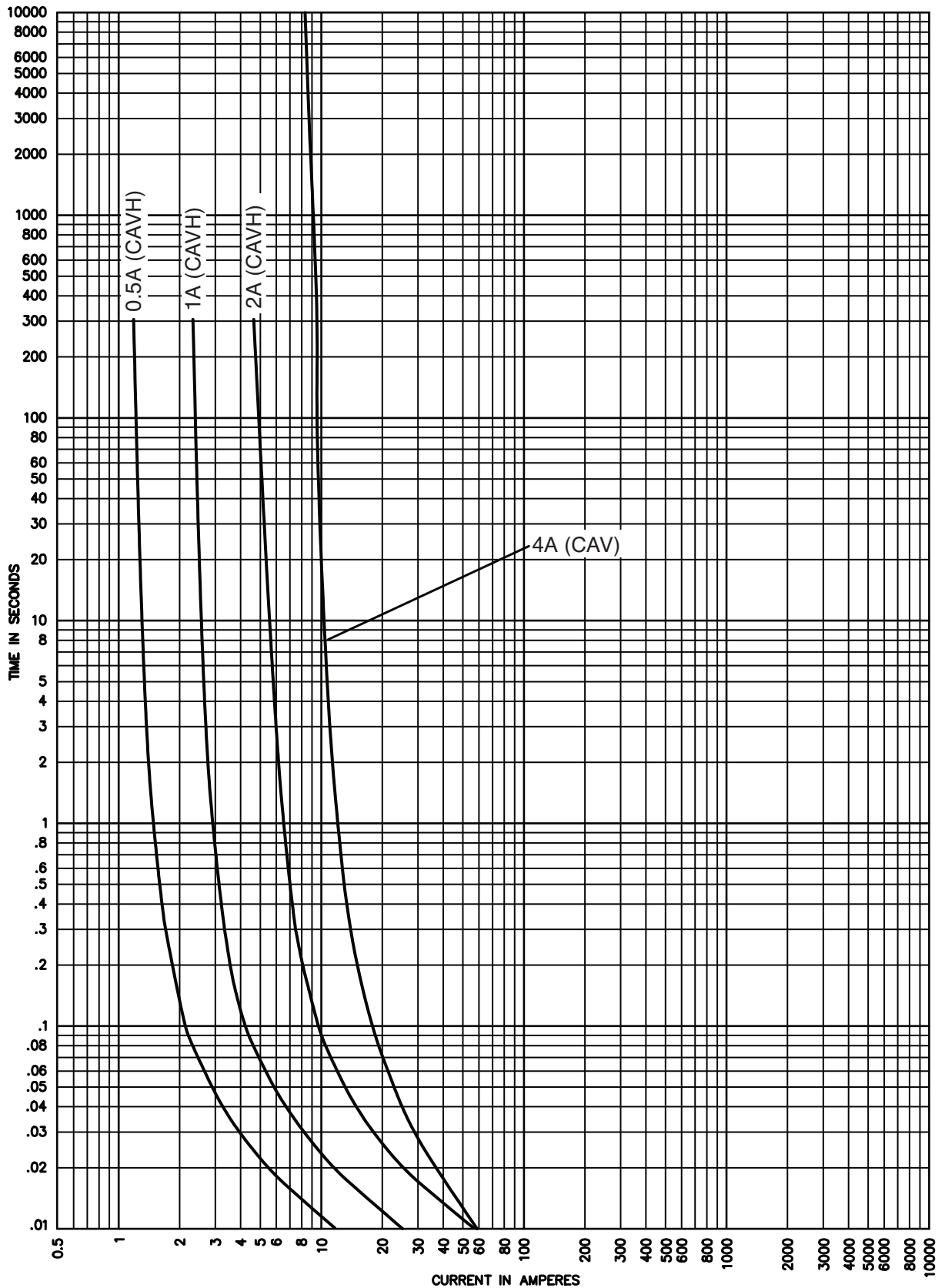

38CAV_, 38CAVH_

38kV peak let-through curves for 38CAVH

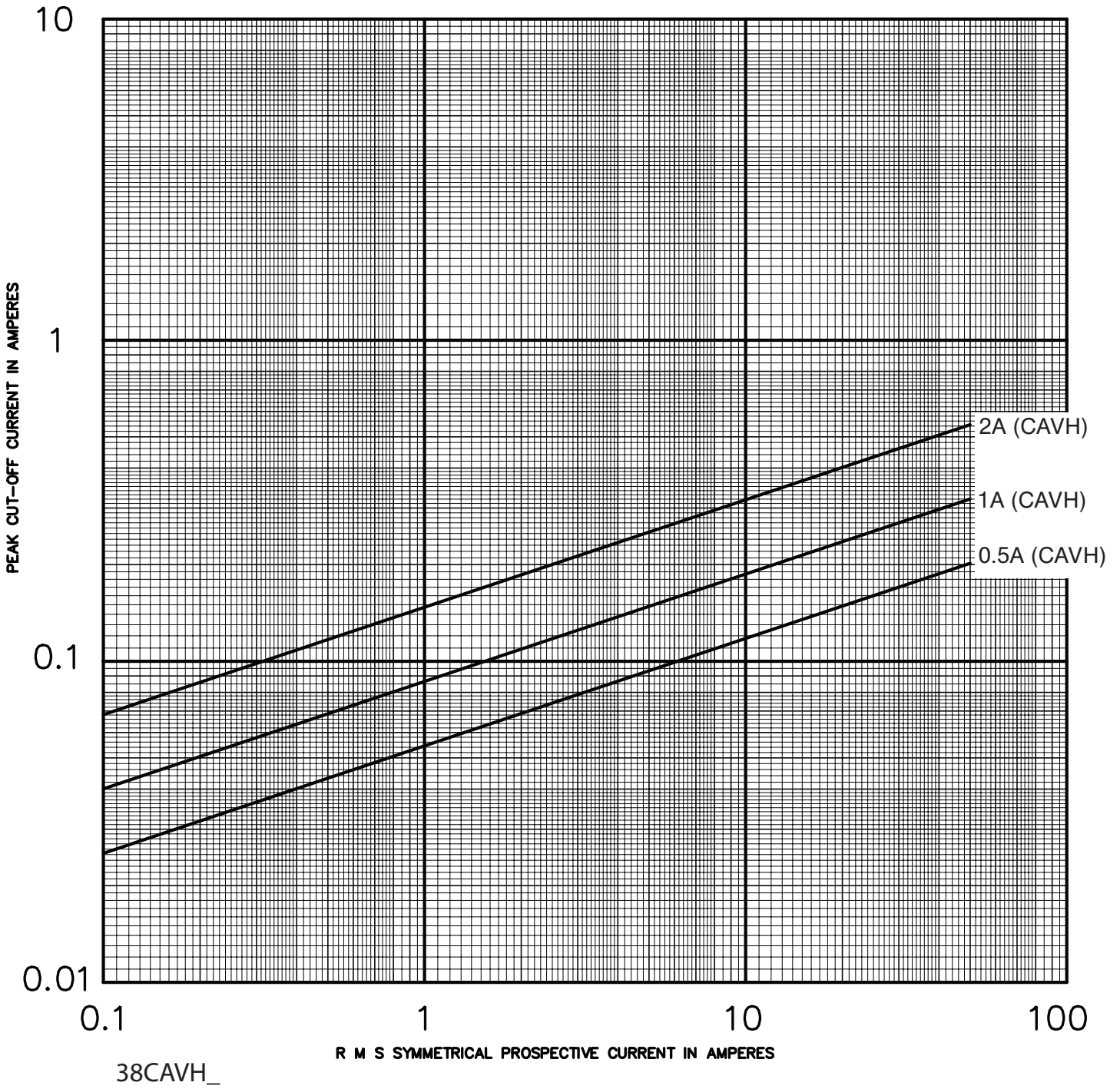

38kV time-current curves — minimum melting for 38CLPT_

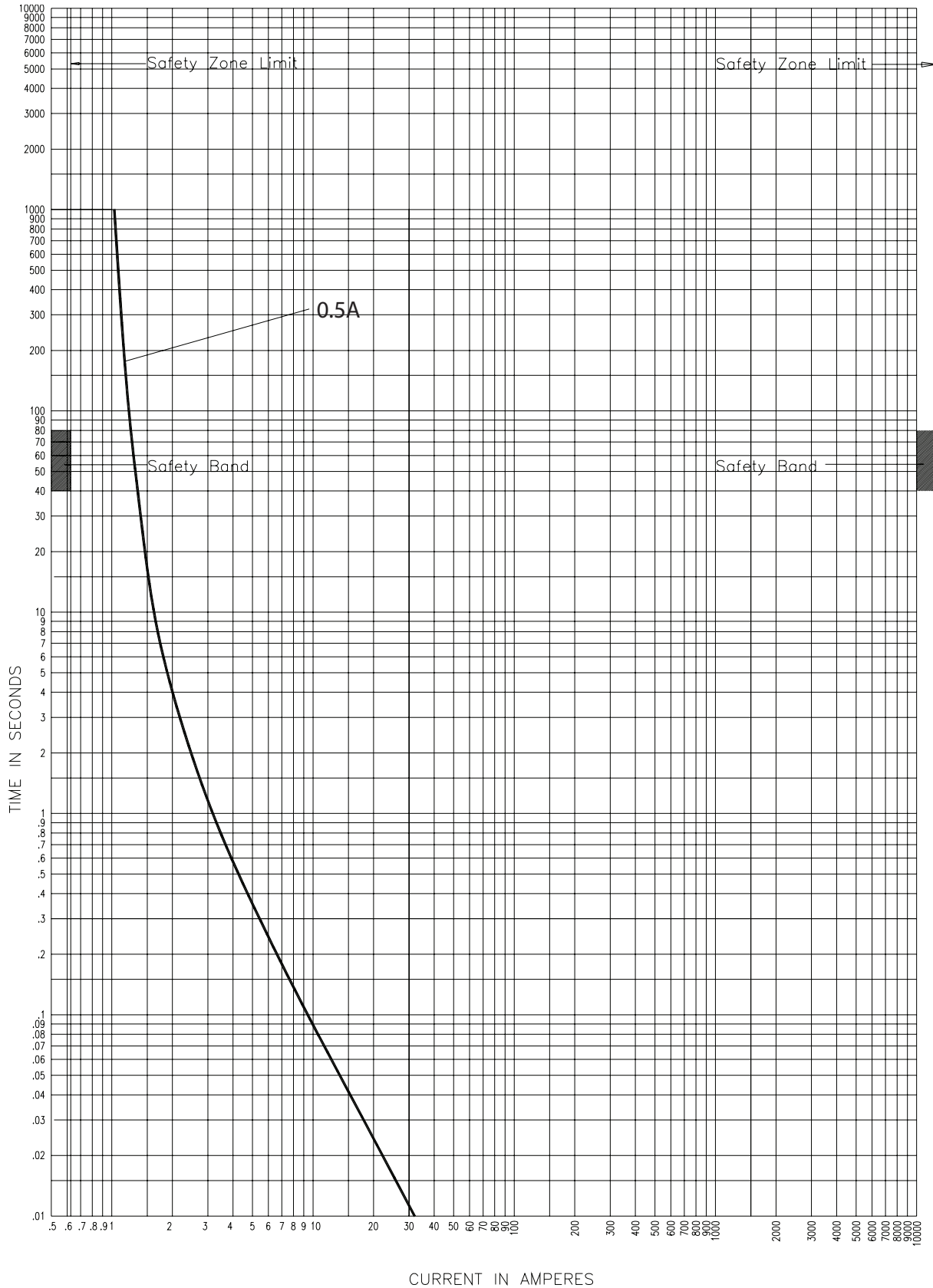

38CLPT_

CURVE 56353208
July 2002
Reference # 563532

38kV time-current curves — total clearing for 38CLPT_

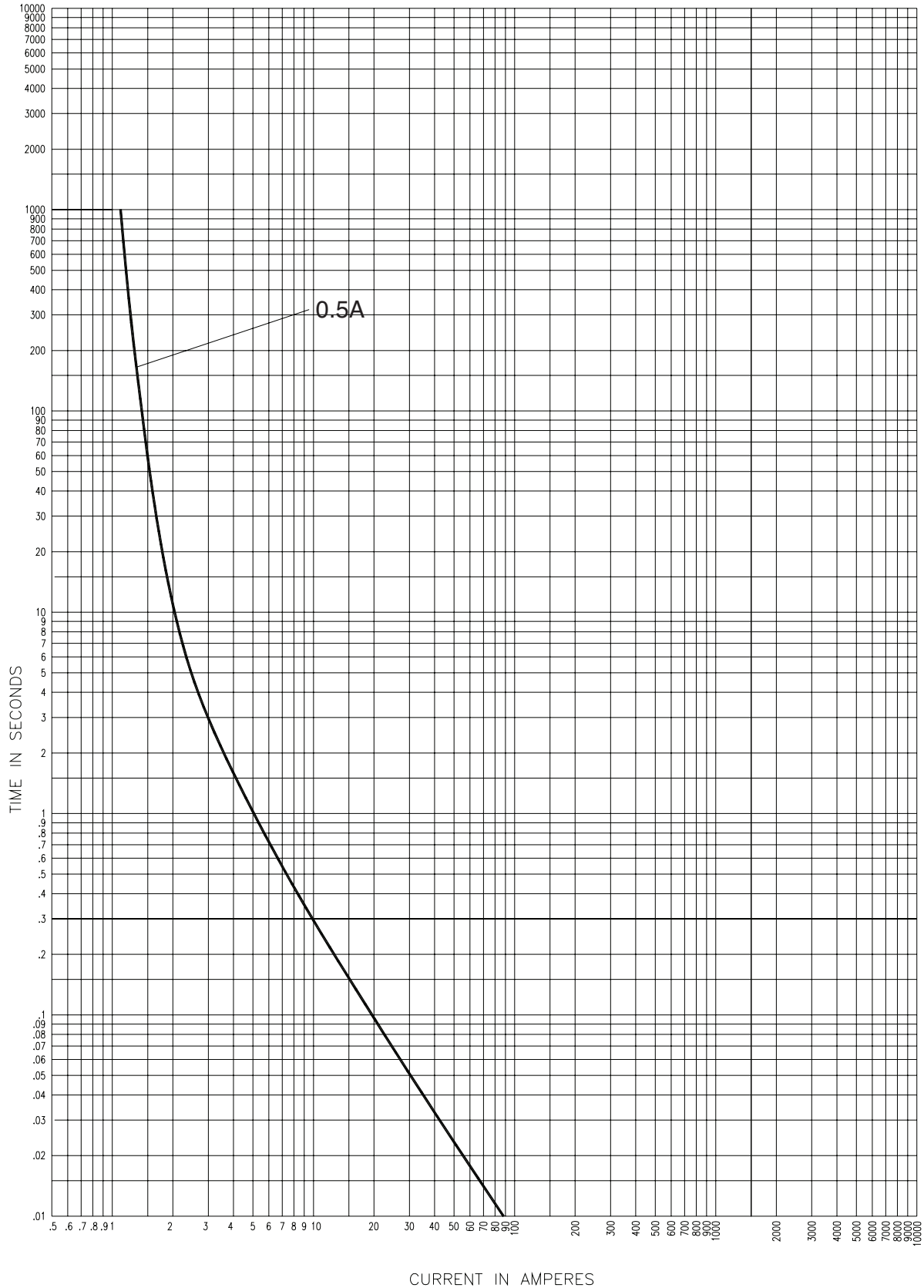

38CLPT_

CURVE 56353308
July 2002
Reference # 563533

38kV peak let-through curves for 38CLPT_

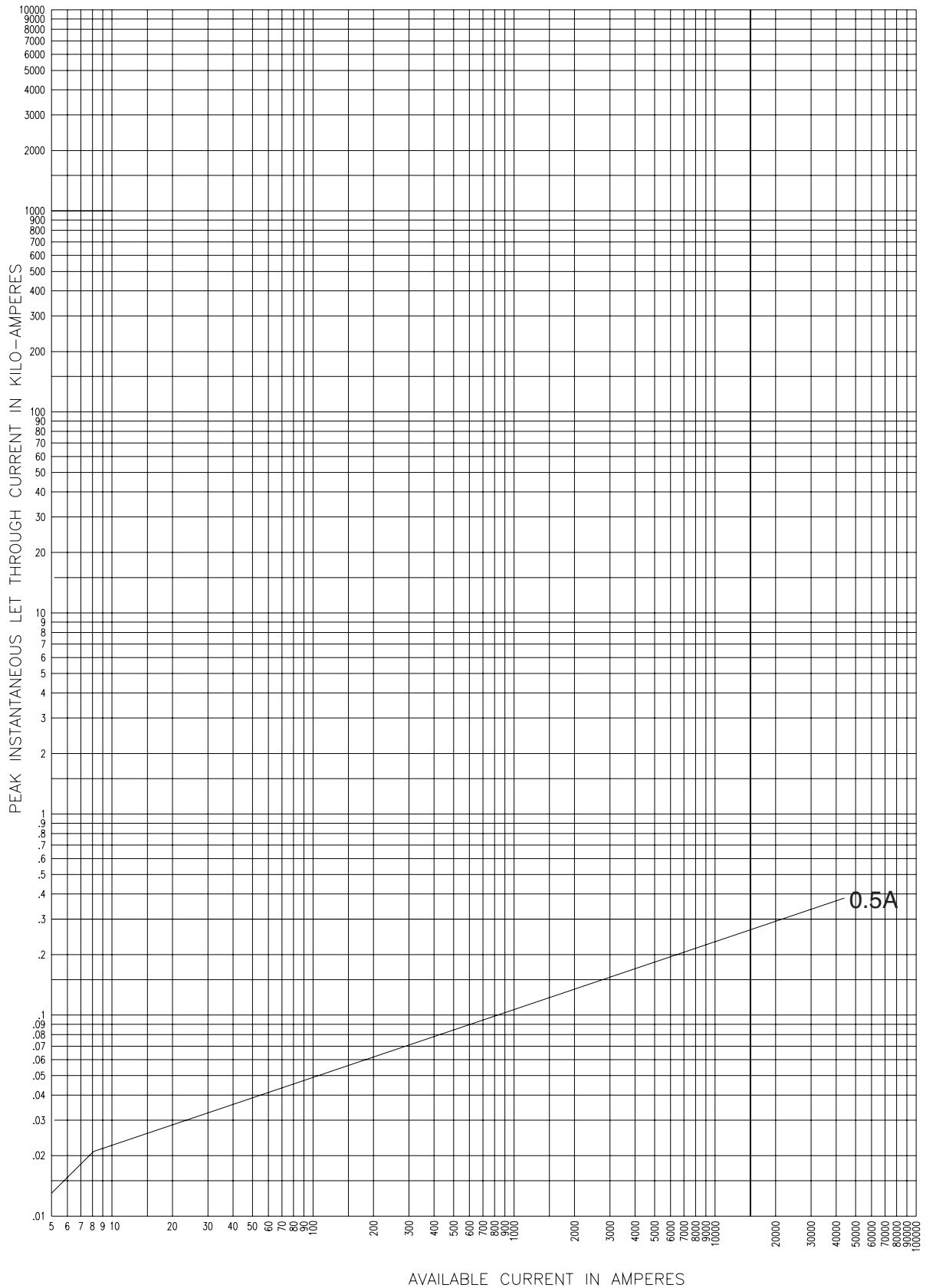

38CLPT_

CURVE 63933901
July 2001
Reference # 639339

PT fuse mountings - in (mm)

Catalog number	Hole centers A	Hole centers B	Overall length C	Hole Inset D	Hole centers E	Contact height F	Overall height G	BIL kV
5.5kV Disconnect†								
5CLPT-GDM-A	9.37 (238)	6 (152.4)	18.63 (473.2)	0.75 (19)	1.75 (44.4)	4.5 (114.3)	9.56 (242.8)	60
5CLPT-PDM-A	9.37 (238)	6 (152.4)	18.63 (473.2)	0.75 (19)	1.75 (44.4)	4.5 (114.3)	9.56 (242.8)	60
5.5kV Non-disconnect								
5CLPT-GNM-A	9.37 (238)	6 (152.4)	18.63 (473.2)	0.75 (19)	1.75 (44.4)	4.5 (114.3)	6.94 (176.2)	60
5CLPT-PNM-A	9.37 (238)	6 (152.4)	18.63 (473.2)	0.75 (19)	1.75 (44.4)	4.5 (114.3)	6.94 (176.2)	60
8.3kV Disconnect†								
8CLPT-GDM-A	9.37 (238)	6 (152.4)	18.63 (473.2)	0.75 (19)	1.75 (44.4)	7 (177.8)	12.06 (306.3)	75
8CLPT-GDM-B	9.37 (238)	6 (152.4)	18.63 (473.2)	0.75 (19)	1.75 (44.4)	7 (177.8)	12.06 (306.3)	75
8CLPT-PDM-A	9.37 (238)	6 (152.4)	18.63 (473.2)	0.75 (19)	1.75 (44.4)	7 (177.8)	12.06 (306.3)	75
8CLPT-PDM-B	12.74 (323.6)	6 (152.4)	22 (558.8)	0.75 (19)	1.75 (44.4)	7 (177.8)	12.06 (306.3)	75
8.3kV Non-disconnect								
8CLPT-GNM-A	9.37 (238)	6 (152.4)	18.63 (473.2)	0.75 (19)	1.75 (44.4)	7 (177.8)	9.44 (239.8)	75
8CLPT-PNM-A	9.37 (238)	6 (152.4)	18.63 (473.2)	0.75 (19)	1.75 (44.4)	7 (177.8)	9.44 (239.8)	75
8CLPT-GNM-B	12.75 (323.8)	6 (152.4)	22 (558.8)	0.75 (19)	1.75 (44.4)	7 (177.8)	9.44 (239.8)	75
8CLPT-PNM-B	12.75 (323.8)	6 (152.4)	22 (558.8)	0.75 (19)	1.75 (44.4)	7 (177.8)	9.44 (239.8)	75
15.5kV Disconnect†								
15CLPT-GDM-A	12.74 (323.6)	6 (152.4)	22 (558.8)	0.75 (19)	1.75 (44.4)	7 (177.8)	12.06 (306.3)	95
15CLPT-PDM-A	12.74 (323.6)	6 (152.4)	22 (558.8)	0.75 (19)	1.75 (44.4)	7 (177.8)	12.06 (306.3)	95
15CLPT-GDM-B	17.46 (443.5)	6 (152.4)	26.63 (676.4)	0.75 (19)	1.75 (44.4)	7 (177.8)	12.06 (306.3)	95
15CLPT-PDM-B	17.46 (443.5)	6 (152.4)	26.63 (676.4)	0.75 (19)	1.75 (44.4)	7 (177.8)	12.06 (306.3)	95
15.5kV Non-disconnect								
15CLPT-GNM-A	12.74 (323.6)	6 (152.4)	22 (558.8)	0.75 (19)	1.75 (44.4)	7 (177.8)	9.44 (239.8)	95
15CLPT-PNM-A	12.74 (323.6)	6 (152.4)	22 (558.8)	0.75 (19)	1.75 (44.4)	7 (177.8)	9.44 (239.8)	95
15CLPT-GNM-B	17.46 (443.5)	6 (152.4)	26.63 (676.4)	0.75 (19)	1.75 (44.4)	7 (177.8)	9.44 (239.8)	95
15CLPT-PNM-B	17.46 (443.5)	6 (152.4)	26.63 (676.4)	0.75 (19)	1.75 (44.4)	7 (177.8)	9.44 (239.8)	95
25.5kV Disconnect†								
25CLPT-PDM-A	19.12 (485.6)	7 (177.8)	26.63 (676.4)	0.75 (19)	1.75 (44.4)	12 (304.8)	17.06 (433.3)	150
25.5kV Non-disconnect								
25CLPT-PNM-A	26.63 (676.4)	7 (177.8)	26.63 (676.4)	0.75 (19)	1.75 (44.4)	12 (304.8)	14.75 (374.6)	150

† Disconnect mountings provide a means for fuse extraction only. Do not use a disconnect mounting for load switching or fuse removal while energized.

Disconnect mountings†

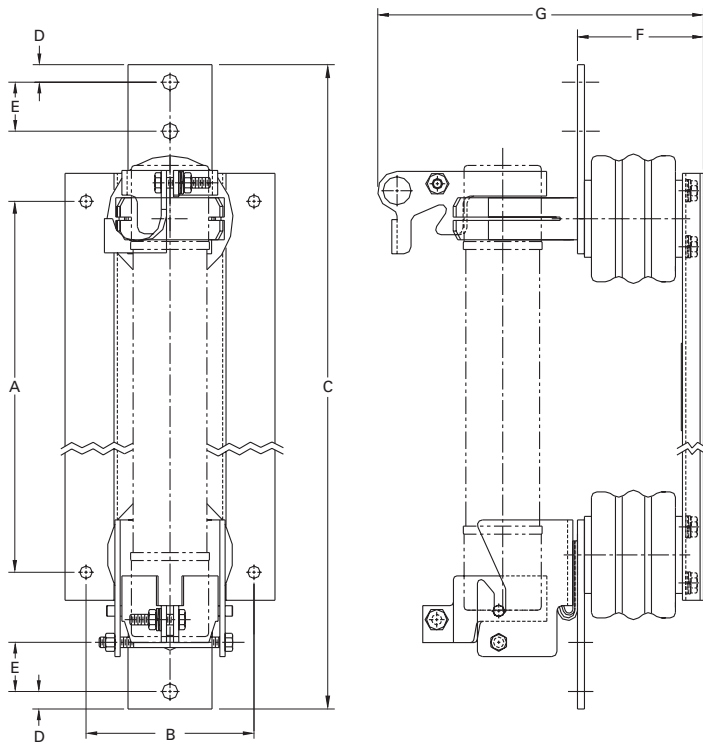

Non-disconnect mountings

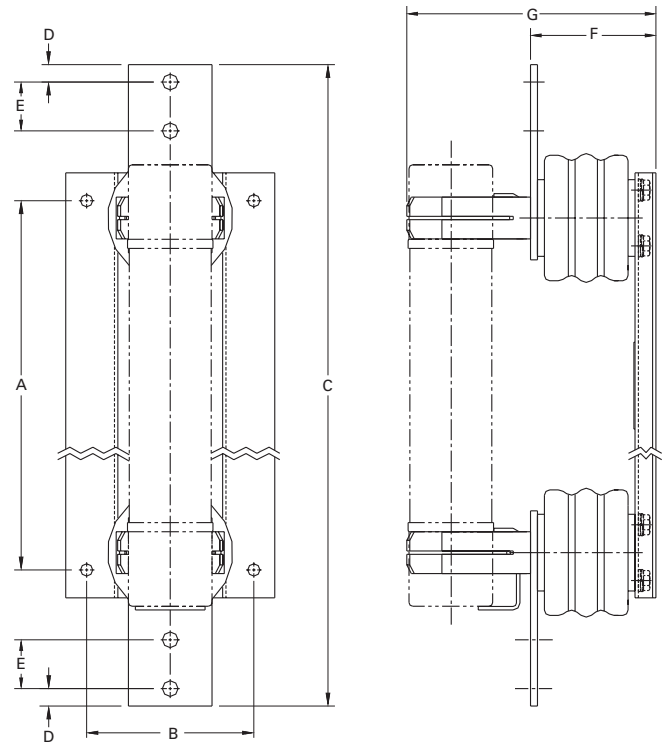

† Disconnect mountings provide a means for fuse extraction only. Do not use a disconnect mounting for load switching or fuse removal while energized.

The only controlled copy of this data sheet is the electronic read-only version located on the Eaton network drive. All other copies of this document are by definition uncontrolled. This bulletin is intended to clearly present comprehensive product data and provide technical information that will help the end user with design applications. Eaton reserves the right, without notice, to change design or construction of any products and to discontinue or limit distribution of any products. Eaton also reserves the right to change or update, without notice, any technical information contained in this bulletin. Once a product has been selected, it should be tested by the user in all possible applications.

Eaton
1000 Eaton Boulevard
Cleveland, OH 44122
United States
Eaton.com

Bussmann Division
114 Old State Road
Ellisville, MO 63021
United States
Eaton.com/bussmannseries

© 2016 Eaton
All Rights Reserved
Printed in USA
Publication No. 6002 – BU-SB15149
March 2016

Eaton and Bussmann are valuable trademarks of Eaton in the US and other countries. You are not permitted to use the Eaton trademarks without prior written consent of Eaton.

For Eaton's Bussmann series
product information,
call **1-855-287-7626** or visit:
Eaton.com/bussmannseries

Компания «Океан Электроники» предлагает заключение долгосрочных отношений при поставках импортных электронных компонентов на взаимовыгодных условиях!

Наши преимущества:

- Поставка оригинальных импортных электронных компонентов напрямую с производств Америки, Европы и Азии, а так же с крупнейших складов мира;
- Широкая линейка поставок активных и пассивных импортных электронных компонентов (более 30 млн. наименований);
- Поставка сложных, дефицитных, либо снятых с производства позиций;
- Оперативные сроки поставки под заказ (от 5 рабочих дней);
- Экспресс доставка в любую точку России;
- Помощь Конструкторского Отдела и консультации квалифицированных инженеров;
- Техническая поддержка проекта, помощь в подборе аналогов, поставка прототипов;
- Поставка электронных компонентов под контролем ВП;
- Система менеджмента качества сертифицирована по Международному стандарту ISO 9001;
- При необходимости вся продукция военного и аэрокосмического назначения проходит испытания и сертификацию в лаборатории (по согласованию с заказчиком);
- Поставка специализированных компонентов военного и аэрокосмического уровня качества (Xilinx, Altera, Analog Devices, Intersil, Interpoint, Microsemi, Actel, Aeroflex, Peregrine, VPT, Syfer, Eurofarad, Texas Instruments, MS Kennedy, Miteq, Cobham, E2V, MA-COM, Hittite, Mini-Circuits, General Dynamics и др.);

Компания «Океан Электроники» является официальным дистрибьютором и эксклюзивным представителем в России одного из крупнейших производителей разъемов военного и аэрокосмического назначения «JONHON», а так же официальным дистрибьютором и эксклюзивным представителем в России производителя высокотехнологичных и надежных решений для передачи СВЧ сигналов «FORSTAR».



JONHON

«JONHON» (основан в 1970 г.)

Разъемы специального, военного и аэрокосмического назначения:

(Применяются в военной, авиационной, аэрокосмической, морской, железнодорожной, горно- и нефтедобывающей отраслях промышленности)

«FORSTAR» (основан в 1998 г.)

ВЧ соединители, коаксиальные кабели,
кабельные сборки и микроволновые компоненты:

(Применяются в телекоммуникациях гражданского и специального назначения, в средствах связи, РЛС, а так же военной, авиационной и аэрокосмической отраслях промышленности).



Телефон: 8 (812) 309-75-97 (многоканальный)

Факс: 8 (812) 320-03-32

Электронная почта: ocean@oceanchips.ru

Web: <http://oceanchips.ru/>

Адрес: 198099, г. Санкт-Петербург, ул. Калинина, д. 2, корп. 4, лит. А